

Introduction

Thank you for purchasing the Vodafone 802SH.

- For proper handset use, read this manual beforehand.
- This manual was created exclusively for Vodafone 802SH handsets sold in Japan.
- Keep this manual in a convenient place for reference.
- Accessible Vodafone services may vary by service area, subscription, etc.

Note

- Copying this manual in whole or part without authorisation is prohibited.
- Manual content is subject to change without prior notice.
- Efforts have been made to ensure the accuracy and clarity of this manual. Please contact Customer Service, General Information (see **P.16-32**) concerning unclear or missing information.

Symbols

In this manual, most operations are described with handset open (clamshell open: see **P.1-13**). Sample screen shots, etc. are provided for reference only. Actual handset windows, menus, etc. may differ in appearance.

Multi Selector

Use Multi Selector to select menu items, move cursor, scroll, etc. In this manual, Multi Selector operations are indicated as shown to the right.

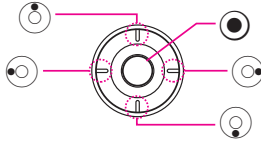

Basic Multi Selector Operations

- : Press or
- : Press or
- : Press , , or

Side Keys

Use Side Keys when Display is in Viewer position (see **P.1-14**). In this manual, Side Keys are indicated as shown to the right. is not inscribed on the actual Clear Key.

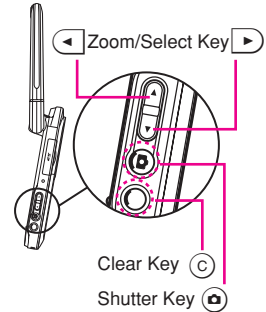

Handset Menu Operations

In this manual, menu operations are indicated as follows:

Select menu item and press ● Operations such as selecting a file



Press ●

Press ● or ☞

In this **Vodafone 802SH Instruction Manual**, **Vodafone 802SH** is abbreviated as **802SH**.

Accessories

■ Battery (SHBW01)*

(Type 1 Lithium-ion Battery)

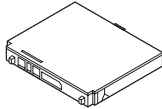

■ Desktop Holder (SHEW01)*

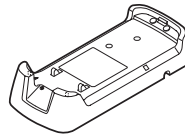

■ Multi Stereo Headphones

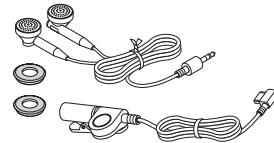

■ AC Charger (SHCW01)*

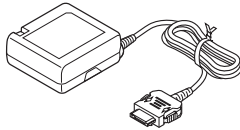

■ Utility Software (CD-ROM)

*May also be purchased separately.

Tip ►

- For accessory-related information, please contact Vodafone Customer Centre, General Information (see P.16-32).
- 802SH is compatible with SD Memory Cards. SD Memory Card is not included in this package. Purchase SD Memory Card to use Memory Card-related handset functions.

Contents

Symbols	i
Accessories	iii
Contents	iv
Safety Precautions	xv
General Notes	xxv

Basic Operations

1 Getting Started

Function & Feature Preview	1-2
USIM Card	1-4
■ General Information & Precautions	1-4
■ Inserting & Removing USIM Card	1-5
■ USIM PINs	1-7
Handset Parts & Functions	1-8
■ Handset	1-8
■ Display	1-11
Display Positions & Keys	1-13
■ Display Positions	1-13
■ Key Press Methods	1-15
■ Side Key Assignments (Viewer)	1-15
Battery & Charger	1-16
■ Getting Started	1-16
■ Installing & Removing Battery	1-20
■ AC Charger	1-22
■ Desktop Holder	1-23
■ In-Car Charger	1-24

Memory Card	1-25
■ Precautions	1-25
■ Inserting & Removing SD Memory Card	1-26
Handset Power On/Off	1-28
■ Keypad Lock	1-29
■ Pen Light	1-29
● Pen Light On/Off	1-29
Handset Menus	1-30
■ Main Menu	1-30
■ Soft Keys	1-31
■ User Shortcuts	1-32
● Assign	1-32
● Move	1-32
● Set to Default	1-32
Security Codes	1-33
■ Handset Code	1-33
■ Centre Access Code	1-33
■ Network Password	1-33

2 Basic Handset Operations

Initiating a Voice Call (in Japan)	2-2
● Viewer Position	2-3
● Hold	2-3
● Mute Microphone	2-3
■ Redial	2-4
Incoming Voice Call	2-5
● Viewer Position	2-5
■ Calling from Received Calls	2-7
Rejecting Incoming Calls	2-8
■ Rejecting a Call	2-8

Using Phone Book	4-8
■ Dialling from Phone Book.....	4-8
● By Reading Order	4-9
● By Group.....	4-9
● By Katakana.....	4-9
■ Speed Dial.....	4-10
Editing Phone Book	4-10
■ Correction/Change	4-10
■ Copying Phone Book Entries	4-11
■ Deleting Phone Book Entries	4-11
Speed Dial List	4-12
■ Saving Phone Numbers	4-12
■ Deleting Phone Numbers	4-12
Owner Profile	4-13
● Edit.....	4-13
● Delete.....	4-13

5 TV Call

Getting Started	5-2
Initiating a TV Call	5-3
● Viewer Position	5-3
Answering a TV Call	5-3
● Viewer Position	5-3
Engaged TV Call Operations	5-4
● Switch Cameras.....	5-4
● Swap Images	5-4
● Send Alternative Image.....	5-4
● Mute.....	5-4

TV Call Settings	5-5
● Default Image.....	5-5
● Setting Alternative Image.....	5-5
● Loudspeaker	5-5
● Picture Quality.....	5-5
● Backlight	5-5
● Mute Microphone	5-5
● Hold Guidance Pict.....	5-5

6 Camera

Getting Started	6-2
■ Precaution	6-2
■ Mobile Camera Basics	6-2
■ Viewfinder & Key Assignments	6-4
Still Images	6-5
■ Photo Camera Mode	6-5
■ Capturing Still Images	6-6
■ Still Image Functions	6-7
■ Continuous Shoot.....	6-8
■ Adding Frames	6-10
Video	6-10
■ Video Camera Mode	6-10
■ Recording Video.....	6-11
■ Video Recording Operations	6-12
Camera Settings	6-13
■ Shooting Options.....	6-13
● Toggle Preview	6-13
● Picture Size.....	6-13
● Shutter Sound	6-13
● Timer	6-14
● Mobile Light.....	6-14

■ Image Settings	6-15
● Exposure.....	6-15
● Picture Size.....	6-15
● Scene.....	6-15
● Picture Quality.....	6-16
● Record Time	6-16
● Microphone	6-17
● Video Encode.....	6-17
■ Additional Settings.....	6-17
● Help.....	6-17
● Save to.....	6-17
● Select Mode.....	6-18
● Auto Save	6-18
Opening Images & Playing Video	6-18
■ Opening Still Images	6-18
■ Playing Video	6-18
● QVGA Size Images.....	6-18
Sending Still Images & Video	6-19
■ Still Images.....	6-19
■ Video Clips	6-19

7 Media Player

Media Player	7-2
Playing Music	7-3
■ Playback.....	7-4
■ Playback Settings.....	7-5
● Tone Control	7-5
● Playback Pattern.....	7-6
Playing Video	7-6
■ Playback.....	7-7
■ Playback Settings.....	7-7
● Playback Pattern.....	7-7
● Backlight	7-7
● Display Size	7-7
Editing Video	7-8
■ Selecting Start and End Points.....	7-8
■ Cropping Video Clips.....	7-8
■ Editing Subtitles.....	7-9
● Duration	7-9
● Display Position	7-9
● Font Size.....	7-9
● Scrolling	7-10
● Background Colour	7-10
● Font Colour	7-10
● Highlight	7-10
● Blink	7-10
● Reset Effects.....	7-10
■ Deleting All Subtitles	7-11
Managing Video & Music Files.....	7-11
■ Adding New Playlist.....	7-11
■ Adding Clips/Tracks	7-12
■ Deleting Files in SD VIDEO & SD AUDIO.....	7-12

8 Managing Files

Data Folder	8-2
■ File Organisation	8-2
■ Sorting Files	8-3
Opening Files	8-4
■ SVG Files	8-5
Using Files	8-5
■ Wallpaper	8-5
■ Phone Book Picture	8-5
■ Ringvideo & Ringtone	8-6
Editing Images	8-6
■ Changing Image Size	8-6
■ Enlarging/Reducing Image	8-8
■ Visual Effects	8-8
■ Face Arrange	8-9
■ Panorama Images	8-11
■ Split Screen	8-12
■ Additional Picture Effects	8-13
● Reformat file	8-13
● Add Frame	8-13
● Rotate	8-13
Text Templates	8-13
■ New Entry	8-13
■ Editing Templates	8-13
■ Deleting Templates	8-13
Editing Files & Folders	8-14
■ Adding Folders	8-14
■ Changing File Names	8-14
■ Deleting Files & Folders	8-14
■ Copying/Moving Files	8-15

9 Connectivity

Getting Started	9-2
Bluetooth	9-3
■ Getting Started	9-3
■ Bluetooth Operations	9-5
■ Bluetooth Settings	9-8
● Device Name	9-8
● Bluetooth Timeout	9-8
● Handsfree Setting	9-8
Infrared	9-9
■ Getting Started	9-9
■ Transferring Files	9-10
PC Transmissions	9-12
■ Utility Software	9-13
■ 3G/GSM GPRS Modem	9-13
■ Handset Manager	9-14
Network Settings	9-14
● Add, Edit & Delete	9-14
● Set Preferred	9-15
● Network Information	9-15
Internet Setting	9-15
■ Profile Contents	9-15
■ Settings	9-17
● Create New	9-17
● Activate	9-17
● Edit	9-17
● Copy	9-17
● Delete	9-17
● Create New	9-18
● Edit	9-18
● Copy	9-18
● Delete	9-18

■ Additional Settings.....	9-18	Sound Settings.....	10-6
● Re-Provisioning.....	9-18	Clock Settings.....	10-7
● Clear DNS Cache.....	9-18	● Set Date/Time.....	10-7
● White List.....	9-18	● Time/Date Format.....	10-7
Backup & Restore.....	9-19	● Time Zone/Daylight Saving.....	10-7
■ Handset to Memory Card.....	9-20	● Calendar Format.....	10-7
■ Memory Card to Handset.....	9-20	User Dictionary.....	10-8
10 Additional Functions		■ Entries (Partly Japanese Only).....	10-8
Mode Settings.....	10-2	● New Entry.....	10-8
● Mode Settings.....	10-2	● Edit/Delete.....	10-8
● Set to Default.....	10-2	■ 802SH Download Dictionary (Japanese Only).....	10-8
■ Customising Incoming Communication Settings.....	10-2	● Acquire Dictionary.....	10-8
● Volume.....	10-2	● Cancel.....	10-8
● Ringtone/Ringvideo.....	10-2	Call Settings.....	10-9
● Vibration.....	10-3	■ International Call.....	10-9
● External Light.....	10-3	● Int'l Prefix.....	10-9
● Any Key Answer.....	10-3	● Country Codes.....	10-9
■ Customising System Sounds.....	10-3	■ Additional Settings.....	10-9
● Keypad Tones.....	10-3	● Display Call Info.....	10-9
● Warning Tone & Power On/Off Sound.....	10-3	● Minute Minder.....	10-9
Display.....	10-4	● Display Call Timer.....	10-9
■ Display Settings.....	10-4	Handset Security.....	10-10
● Wallpaper.....	10-4	■ PIN.....	10-10
● System Graphics.....	10-4	● Switch On/Off.....	10-10
● Clock & Calendar.....	10-5	● Change PIN.....	10-10
● Font Settings.....	10-5		
● Greeting Message.....	10-5		
● Show Operator Name.....	10-5		
● Language.....	10-5		
■ Light Settings.....	10-6		
● Backlight.....	10-6		
● Brightness.....	10-6		
● Display Saving.....	10-6		

■ Handset Locks.....	10-11	■ Deleting Entries.....	11-4
● Phone Lock.....	10-11	● This Appointment.....	11-4
● Handset Lock.....	10-11	● All This Day.....	11-4
● Phone Book Lock.....	10-11	● All This Month.....	11-5
■ Secret Mode.....	10-12	● Up to Last Month.....	11-5
● Show Secret Data.....	10-12	● All Appointments.....	11-5
■ Changing Handset Code.....	10-12	Alarm.....	11-5
● Change Handset Code.....	10-12	■ Setting Alarm.....	11-5
Memory Settings.....	10-13	● Assign Alarm Tone.....	11-6
● Memory Status.....	10-13	● Assign Alarm Video.....	11-6
● Format Card.....	10-13	● Snooze.....	11-6
LBS (Location Based Service) Settings.....	10-13	● Alarm Volume.....	11-7
● LBS URL Setting.....	10-13	● Duration.....	11-7
● Datum On/Off.....	10-13	● Vibration.....	11-7
Reset.....	10-14	■ Cancelling & Reactivating Alarm.....	11-7
● Reset Settings.....	10-14	● Switch Off.....	11-7
● Reset All.....	10-14	● Switch On.....	11-7
		■ Deleting Alarm.....	11-7
		● Reset Alarm.....	11-7
		● Clear All.....	11-7
11 Tools		Calculator.....	11-8
Calendar.....	11-2	Voice Recorder.....	11-9
■ Opening Calendar.....	11-2	■ Recording Voice.....	11-9
■ Saving Entries.....	11-2	■ Recording Settings.....	11-10
● Assign Tone.....	11-3	● Record Time.....	11-10
● Assign Video.....	11-3	● Save Rec. to.....	11-10
● Duration.....	11-3	■ Playback.....	11-10
● Repeat.....	11-4	Barcode.....	11-11
● Secret.....	11-4	● Scanning during Text Entry.....	11-13
■ Opening Entries.....	11-4	● Open Barcode.....	11-13
■ Editing Entries.....	11-4	● Scanned Results.....	11-13
		Creating QR Codes.....	11-14
		● Phone Book.....	11-14
		● Text Input.....	11-14
		● Data Folder.....	11-14

Text Scanner	11-15	■ Using A Dictionary	11-27
● Scanning during Text Entry.....	11-16	● Look Up Word	11-27
Stopwatch	11-17	● Properties.....	11-27
Tasks	11-18	Phone Help	11-28
■ Saving Entries	11-18	12 Optional Services	
● Assign Tone	11-19	Optional Service Overview	12-2
● Assign Video	11-19	Call Forwarding	12-2
● Duration	11-19	● Call Forwarding	12-3
● Secret.....	11-19	● Cancel Forwarding.....	12-3
■ Opening Entries.....	11-19	● Status.....	12-3
■ Editing Entries	11-19	Voice Mail	12-4
■ Deleting Entries	11-20	● Voice Mail	12-4
● This Task	11-20	● Cancel Voice Mail	12-4
● All Completed Tasks	11-20	● Status	12-4
● All Tasks	11-20	● Play Voice Mail	12-5
World Clock	11-20	Call Waiting	12-5
Countdown Timer	11-21	● Start/Cancel Call Waiting	12-5
Expenses Memo	11-22	● Status.....	12-5
● Add New Expense	11-22	● Incoming Calls	12-5
● Totals	11-22	Conference Call	12-6
● Edit Category	11-22	● Dial New Number	12-6
Digital Print Order Format (DPOF)	11-22	● Switch Line.....	12-6
■ Selecting Images & Prints	11-23	● Conference Call	12-6
■ Print Settings	11-23	Call Barring	12-7
● Add Date	11-23	■ Restricting Outgoing Calls.....	12-8
● Index Print.....	11-23	● Set Restriction.....	12-8
● Check Print Setting	11-23	● Cancel Restriction	12-8
● Number of Copies	11-23	● Status	12-8
E-Books	11-24	■ Restricting Incoming Calls.....	12-9
■ Reading Content	11-24	● Set/Cancel Restriction	12-9
■ Using E-Book Images.....	11-27		
● As Wallpaper.....	11-27		
● Embedded Information.....	11-27		

■ Rejecting Calls	12-9
● Rejected Numbers	12-9
● Set Reject Number.....	12-9
■ Rejecting Calls without Caller ID	12-9
● Withheld Call.....	12-9
■ Changing Network Password	12-10
● Change N/W Password.....	12-10
Caller ID	12-10
● Show Your Number.....	12-10
● Status.....	12-10

Vodafone live!

13 Vodafone live! Overview

Vodafone live! Basics	13-2
■ Vodafone live! Services.....	13-2
■ Automatic Network Setup.....	13-4
■ Customising Handset Address.....	13-4
Getting Started	13-5
Using Web	13-6
■ Opening Web Menu	13-6
■ Entering URLs Directly	13-7
■ Using URL Log.....	13-7
Basic Operations	13-8
■ Using Linked Info.....	13-9
Advanced Features	13-10
■ Saving to Data Folder.....	13-10
■ Bookmarks & My Saved Page.....	13-11
■ Editing Bookmarks & My Saved Page.....	13-13
● Rename	13-13
● Delete.....	13-13
● Edit URL (only for Bookmarks)	13-13
● Bookmarks Folder.....	13-13

■ Streaming.....	13-14
■ Sub Menu Settings.....	13-15
● Reload Page	13-15
● Send Page	13-15
● Properties.....	13-15
● Browser Data	13-16
● Search This Page	13-16
● Restart Browser	13-16
● About.....	13-16
● Uploading Files	13-16
Other Functions	13-17
■ Basic Settings.....	13-17
● Cookies.....	13-17
● Downloads	13-17
● IMEI Notification.....	13-17
● Scroll Step.....	13-17
● Font Size.....	13-17
● Download to	13-17
■ Security	13-18
● Secure Prompt.....	13-18
● Certificates	13-18
● Root Certificates	13-18
● Authentication	13-18

14 Messaging

Incoming Text Messages.....	14-2
■ Opening New Messages	14-2
■ Retrieving MMS Messages	14-4
■ Using Received Messages.....	14-5
● Reply.....	14-5
● Forward.....	14-5
● Call.....	14-5

Sending Text Messages	14-6	Server Mail	14-29
■ Overview	14-6	■ Retrieving Mail List	14-29
■ Creating a Message	14-7	■ Retrieving Selected Messages	14-30
■ Entering Message Text	14-8	■ Deleting Selected Messages	14-30
■ Attaching Images & Sounds	14-9	■ Forwarding Server Mail	14-31
■ Creating Slides	14-11	Mail Settings	14-31
■ Entering Recipient	14-12	■ General Settings	14-31
■ Entering Subject	14-13	● Home Download	14-31
■ Setting Message Type	14-14	● Roam. Download	14-31
■ Advanced Settings	14-14	● Delivery Report	14-31
● Delivery Report	14-14	● Edit Signature	14-31
● Expiry Time	14-14	● Delivery Rep. Allow	14-32
● Priority	14-15	● Reply History	14-32
● Delivery Time	14-15	■ SMS Settings	14-32
■ Saving to Draft	14-15	● Message Centre	14-32
■ Using Mail Templates	14-16	● Message Format	14-32
Mail Box	14-17	● Reply Path	14-32
■ Mail Box Type	14-17	● Text Optimisation	14-32
■ Checking Messages	14-17	■ MMS Settings	14-33
■ Personal Folders	14-20	● Slide Duration	14-33
■ Replying to Messages	14-23	● Max Message Size	14-33
■ Forwarding Messages	14-23	■ Memory Status	14-33
■ Sending from Draft	14-24		
■ Protecting a Message	14-24		
■ Deleting Messages	14-25		
■ Linked Info	14-26		
■ Saving Attachments to Data Folder	14-27		
■ Mail Box List	14-28		
● Message Details	14-28		
● Read/Unread	14-28		

15 V-applications

V-application Basics	15-2
■ Getting Started	15-2
■ Downloading V-applications	15-3
■ Starting V-applications	15-4
■ Exit, Pause & Resume	15-5
■ Managing V-applications	15-5
● Properties.....	15-5
● Move to Card	15-6
● Delete.....	15-6
Using V-applications	15-6
■ Setting Screensaver	15-6
■ Setting Security Level.....	15-7
Additional Functions	15-8
■ V-application Operational Settings	15-8
● Application Volume	15-8
● Backlight	15-8
● Blink	15-8
● Vibration.....	15-9
● Calls & Alarms	15-9
■ Reset.....	15-9
● Set to Default	15-9
● Memory All Clear	15-9

16 Appendix

Function Menu	16-2
Troubleshooting	16-4
Character Code List	16-9
Pictograph List	16-15
Specifications	16-21
Index	16-23
Warranty & After-Sales Services	16-31
Customer Service	16-32

Safety Precautions

- Read safety precautions before using handset.
- Observe precautions to avoid injury to self or others, or damage to property.
- Vodafone is not liable for any damages resulting from use of this product.

Before Using Handset

■ Symbols

Make sure you thoroughly understand these symbols before reading on.

Symbols and their meanings are described below:



DANGER

Great risk of death or serious injury from improper use



WARNING

Risk of death or serious injury from improper use



CAUTION

Risk of injury or damage to property from improper use

■ Symbols



Prohibited Actions



Compulsory Actions



Attention Required

DANGER

Handset, Battery & Charger

Use only the specified battery, Charger or Holder (see P.iii).



Using non-specified equipment may cause malfunctions, electric shock or fire due to battery leakage, overheating or bursting.

Do not short-circuit Charger Terminals.



Keep metal objects away from Charger Terminals. Keep handset away from necklaces, hairpins, etc.

Battery may leak, overheat, burst or ignite causing injury. Use a case to carry handset.

Battery

Prevent injury from battery leakage, breakage or fire.



Do not:

- Heat or dispose of battery in fire.
- Disassemble, modify or break battery.
- Damage or solder battery.
- Use a damaged or deformed battery.
- Use non-specified charger (see **P.iii**).
- Force battery into handset.
- Charge or place battery near fire, heat sources or in extreme heat.
- Use battery for other equipment.

If battery fluid contacts eyes, do not rub them. Rinse with clean water and consult a doctor immediately.



Eyes may be severely damaged.

WARNING

Handset, Battery & Charger

Do not insert foreign objects into handset.

Do not place metal or flammable objects in handset, Charger or Holder. This may cause fire or electric shock. Keep handset out of the reach of children.



Keep handset out of rain or extreme humidity.

Fire or electric shock may occur.



Keep handset away from liquid-filled containers.

Keep handset, Charger and Holder away from chemicals/liquids. Fire or electric shock may result.



Avoid sources of fire.

Prevent fire or explosion. Do not use handset in the presence of gas or fine particles (coal, dust, metal, etc.).



Do not use Mobile Light near people's faces.

Eyesight may be temporarily affected leading to accidents.



Keep handset, Charger or Holder away from microwave ovens.

Battery or handset may leak, burst, overheat or ignite and cause accidents.



Do not disassemble or modify handset.

- Do not open housing of handset, Charger or Holder; may cause electric shock or injury. Contact Vodafone Customer Centre, Customer Assistance for repairs.
- Do not modify handset, Charger or Holder. Fire or electric shock may result.



If water or foreign matter is inside handset:

Discontinue handset use to prevent fire or electric shock. Turn handset power off, remove battery, unplug Charger and contact Vodafone Customer Centre, Customer Assistance.



WARNING

Handset, Battery & Charger

Do not subject handset to shocks.

Subjecting handset, Charger or Holder to shocks may cause malfunction or injury.

Should the handset break, remove the battery and contact Vodafone Customer Centre, Customer Assistance.

Discontinue handset use. Fire or electric shock may occur.



If an abnormality occurs:

Should there be unusual sound, smoke or odour, discontinue handset use to avoid fire or electric shock. Turn handset power off, remove battery and unplug Charger and contact Vodafone Customer Centre, Customer Assistance.



Handset

Preventing accidents

- For safety, never use handset while driving. Pull over beforehand.

Mobile phone use while driving is prohibited by the revised Road Traffic Law (effective from 1 November 2004).

- Do not use Headphones while driving or riding a bicycle. Accidents may result.
- Moderate volume outside, especially at level/road crossings to avoid accidents.



Do not swing handset by handstrap.

May result in injury or breakage.



Turn handset power off before boarding aircraft.

Using wireless devices aboard aircraft may cause electronic malfunctions or endanger aircraft operation.



Adjusting vibration and Ringtone settings:

Select settings carefully if you have a heart condition or pacemaker.



During lightning storms, turn power off and take shelter.

There is a risk of lightning strike or electric shock.



WARNING

Charger Care

Use only the specified voltage.

Non-specified voltage may cause fire or electric shock.

- **AC Charger: 100 - 240 VAC**

- Vodafone is not liable for problems caused by charging handset abroad.

- **In-Car Charger: 12/24 VDC**



Do not use commercially available transformers.

Use of AC Charger with commercially available transformers may result in fire, electric shock or breakage.



Do not use In-Car Charger inside vehicles with a positive earth.

Fire may result. Use In-Car Charger inside vehicles with a negative earth only.



Charger Care

- Do not touch blades with wet hands. Electric shock may occur.
- Do not use multiple cords in one outlet. May generate excess heat or fire.
- Do not bend, twist, pull or set objects on cord. Exposed wire may cause fire or electric shock.



Do not short-circuit Charger connector.

Keep metal away from connector.

May cause overheating, fire or electric shock.



Do not use Desktop Holder inside vehicles.

Extreme temperature or vibration may cause fire or breakage.



Preventing accidents

Secure In-Car Charger to avoid injury or accidents.



If Charger or In-Car Charger cord is damaged:

May cause fire or electric shock; Contact Vodafone Customer Centre, Customer Assistance to replace.



During lightning storms:

Unplug Charger to avoid breakage, fire or electric shock.



Keep Charger & Desktop Holder out of the reach of children.

Electric shock or injury may occur.



WARNING

Battery

- If battery does not charge properly, stop charging. Battery may overheat, burst or ignite.
- If there is leakage or abnormal odour, avoid fire sources. It may catch fire or burst.



If there is abnormal odour, excessive heat, discolouration or distortion, remove battery from handset.
It may leak, overheat or explode.



Handset Use & Electronic Medical Equipment

This section is based on "Guidelines on the Use of Radio Communications Equipment such as Cellular Telephones and Safeguards for Electronic Medical Equipment" (Electromagnetic Compatibility Conference, April 1997) and "Report of Investigation of the Effects of Radio Waves on Medical Equipment, etc." (Association of Radio Industries and Businesses, March 2001).

Persons with implanted pacemakers or defibrillators should keep handset more than 22 cm away.

Implanted pacemakers or defibrillators may malfunction due to radio waves.



Turn handset power off in crowded places such as trains. People with implanted pacemakers or defibrillators may be near.

Implanted pacemakers or defibrillators may malfunction due to radio waves.



Observe these rules when visiting medical institutions:

- Do not take handset into operating rooms or Intensive or Coronary Care Units.
- Keep handset off in hospitals.
- Keep handset off in hospital lobbies. Electronic equipment may be near.
- Obey rules regarding mobile phone use in medical institutions.



Consult manufacturer for radio wave effects on electronic medical equipment.



CAUTION

Handset, Battery & Charger

Handset care

- Place handset on stable surfaces to avoid malfunction or injury.
- Keep handset away from oily smoke or steam. Fire or accidents may result.
- Cold air from air conditioners may condense, resulting in leakage or burnout.
- Keep handset away from direct sunlight (inside vehicles, etc.) or heat sources.
Distortion, discolouration or fire may occur. Battery shape may be affected.
- Keep handset out of extremely cold places to avoid malfunction or accidents.
- Keep handset away from fire sources to avoid malfunction or accidents.



Usage environment

- Excessive dust may prevent heat release and cause burnout or fire.
- Avoid using handset on the beach.
Sand may cause malfunction or accidents.
- Keep handset away from credit cards, phone cards, etc. to avoid data loss.



Handset

Avoid leaving handset in extreme heat (inside vehicles, etc.).

Handset may heat up and lead to burns.



Volume settings

Keep handset volume moderate.

Excessive volume may cause damage to your hearing.



Headphones

- Do not unplug by pulling the cord. May cause damage to the cord.
- Keep plug clean to prevent noise and malfunction.



Inside vehicles:

Handset use may cause electronic equipment to malfunction.



⚠ CAUTION

Handset

Should skin irritation occur, discontinue handset use and consult a doctor.

See below for handset materials. They may cause skin irritation, rashes, or itchiness depending on your physical condition.



Parts	Materials & Finishing
Housing (Main Display side)	Magnesium alloy/Acrylic baking finish (sealer: epoxy baking finish)
Housing (Display back/bottom side, Keypad/Battery side), Battery Cover, Memory Card Slot Cover, Outer Cover (Display side)	ABS resin/Acrylic UV curing painting (sealer: acrylic painting)
Display window	Acrylic resin
Logo badge 1, Logo badge 2 (below Keypad)	UV curing resin
Lens cover	Acrylic resin
Small Light window	ABS resin/Chrome plating (sealer: nickel, copper)/PC resin/Acrylic resin
Camera Ornament	ABS resin (deposition/sealer: tin)/Acrylic UV curing painting
Screw cover (above Display/Keypad)	Urethane resin
Screw cover (below Display)	PET
Screw cover (hinge)	UV curing resin
Side Keys	ABS resin (chrome plating/sealer: nickel, copper)/PC resin
Multi Selector, Function Key, Left Soft Key, Right Soft Key	ABS resin (chrome plating/sealer: nickel, copper)
Start Key, Power On/Off Key	ABS resin (chrome plating/sealer: nickel, copper)/PC resin
Shortcuts & A/a Key, Clear Key, Multimedia/Text Key	PC resin/Acrylic UV curing painting (sealer: acrylic painting)
Headphone Connector Cover, External Device Connector Cover	Elastomeric resin
Battery	PC resin
Charger Terminal	Nylon 6T/Brass, Au plating (sealer: nickel, copper)
Screw (Display side, Keypad side)	SWCH12A/Ni plating
SIM pin	Phosphor bronze, nickel plating, palladium-nickel alloy plating, gold plating
SIM cover	SUS

CAUTION

Charger Care

Charger & In-Car Charger

- Grasp plug (not cord) to disconnect Charger. May cause fire/electric shock.
- Keep cord away from heaters. Exposed wire may cause fire or electric shock.
- Stop use if plug is hot or improperly connected. May cause fire/electric shock.
- Keep In-Car Charger socket clean. May overheat and cause injury.



Do not touch Desktop Holder while in use.

May cause burns.



Use only the specified fuse.

1A fuse for In-Car Charger.
Or may cause breakage/fire.



Always charge handset in a well-ventilated area.

Avoid covering/wrapping Charger/Desktop Holder.
May cause damage/fire.



Do not use In-Car Charger when engine is off.

Start engine before use. Or car battery may be weakened.



Long periods of disuse

Be sure to unplug Charger or In-Car Charger after use.



Handset maintenance

When cleaning, disconnect Charger/In-Car Charger to prevent shock/injury.



Installing In-Car Charger

Properly position the cable for safe driving to avoid injury or accidents.



CAUTION

Battery

Do not throw or abuse battery.
Battery may overheat, burst or ignite.



Do not leave battery in direct sunlight or inside vehicles.
Overheating/fire may occur.
Performance may deteriorate.



Do not expose battery to liquids.
Performance may deteriorate.



If battery fluid contacts skin or clothes, rinse with clean water immediately.



- Do not dispose of exhausted batteries with ordinary refuse. Tape over battery terminals before disposal, or bring them to a Vodafone shop.
Follow local regulations regarding battery disposal.
- Keep battery out of the reach of children.

- Charge battery within a range of 5°C - 35°C. Out of this range, battery may leak/overheat or performance may deteriorate.



- If your child is using handset, explain all instructions and supervise usage.
- If there is abnormal odour or excessive heat, stop using battery and call Vodafone Customer Centre, Customer Assistance.
- Do not leave battery uncharged. Charge at least once every 6 months.

General Notes

General Use

- Vodafone is not liable for any damages resulting from accidental loss/alteration of handset or SD Memory Card data. Please keep separate records of Phone Book entries, etc.
- Handset transmissions may be disrupted inside buildings, tunnels or underground, or when moving into/out of such places.
- Use handset without disturbing others.
- Handsets are radios as stipulated by the Radio Law. Under the Radio Law, handsets must be submitted for inspection upon request.
- Handset use near landlines, TVs or radios may cause interference.
- **Beware of eavesdropping.**
Because this service is completely digital, the possibility of signal interception is greatly reduced, however, some transmissions may be overheard.

Eavesdropping

Deliberate/accidental interception of communications constitutes eavesdropping.

Inside Vehicles

- Never use handset when driving.
- Do not park illegally to use handset.
- Handset use may affect a vehicle's electronic equipment.

Aboard Aircraft

Never use handset aboard aircraft (keep power off).
Handset use may impair aircraft operation.

Handset Care

- If handset is left with no battery or an exhausted one, data may be altered/lost. Vodafone is not liable for any resulting damages.
- Use handset between 5°C - 35°C and 35% - 85% humidity. Avoid extreme temperatures/direct sunlight.
- Exposing lens to direct sunlight may damage colour filter and affect image colour.
- Do not drop or subject handset to shocks.
- Clean handset with dry, soft cloth. Using alcohol, thinner, etc. may damage it.
- Do not expose handset to rain, snow or high humidity.
- Never disassemble or modify handset.
- Avoid scratching handset Display.
- When closing handset, keep straps, etc. outside to avoid damaging the Display.
- When using headphones, moderate volume to avoid sound bleed.
- **Handset is not water-proof.**
 - **Avoid exposure to liquids and high humidity.**
 - Keep handset away from precipitation.
 - Cold air from air conditioning, etc. may condense causing corrosion.
 - Avoid dropping handset in a wet area (toilet, bathroom, etc.).
 - On the beach, keep handset away from water and direct sunlight.
 - Perspiration may seep inside handset causing malfunction.
 - **Heavy objects or excessive pressure should be avoided. May cause malfunction or injury.**
 - Do not sit down with handset in a back pocket.
 - Do not place heavy objects on handset in a bag.
- Connect only the specified products to Headphone Connector. Malfunction or damage may result.
- Always turn off handset before removing battery. If battery is removed while saving data or sending mail, data may be lost, changed, or destroyed.

Copyrights

Copyright laws protect sounds, images, computer programmes, databases, other materials and copyright holders. Duplicated material is limited to private use only. Use of materials beyond this limit or without permission of copyright holders may constitute copyright infringement, and be subject to criminal punishment. Comply with copyright laws when using images captured with handset camera.

Video recording and playback are based on **MPEG-4**.

This product is licensed under the MPEG-4 Visual Patent Portfolio License for the personal and non-commercial use of a consumer to (i) encode video in compliance with the MPEG-4 Video Standard ("MPEG-4 Video") and/or (ii) decode MPEG-4 Video that was encoded by a consumer engaged in a personal and non-commercial activity and/or was obtained from a licensed video provider. No licence is granted or implied for any other use. Additional information may be obtained from MPEG LA. See <http://www.mpegla.com>

This product is licensed under the MPEG-4 Systems Patent Portfolio License for encoding in compliance with the MPEG-4 Systems Standard, except that an additional licence and payment of royalties are necessary for encoding in connection with (i) data stored or replicated in physical media which is paid for on a title by title basis and/or (ii) data which is paid for on a title by title basis and is transmitted to an end user for permanent storage and/or use. Such additional licence may be obtained from MPEG LA, LLC. See <http://www.mpegla.com> for additional details.

- Microsoft, MS and Windows are either registered trademarks or trademarks of Microsoft Corp. in the United States and/or other countries.
- The names of other companies and products mentioned herein may be the trademarks of their respective owners.
- Windows Me is an abbreviation for Microsoft® Windows® Millennium Edition operating system (Japanese version).
- Windows 98 SE is an abbreviation for Microsoft® Windows® 98 Second Edition operating system (Japanese version).
- Windows 2000 is an abbreviation for Microsoft® Windows® 2000 operating system (Japanese version).
- Windows XP is an abbreviation for Microsoft® Windows® XP operating system (Japanese version).

QR Code is a registered trademark of DENSO WAVE INCORPORATED.



This product is equipped with JBlend™ designed to accelerate the performance of Java™ Application.
Powered by JBlend™ Copyright 1997-2004 Aplix Corporation.
All rights reserved.



JBlend and JBlend-related brands are trademarks or registered trademarks of Aplix Corporation in Japan and other countries. Java and Java-related brands are trademarks or registered trademarks of Sun Microsystems, Inc. in the United States and other countries.



The SD logo is a trademark.

Chaku-Uta® is a Trademark of Sony Music Entertainment (Japan) Inc.

Licensed by QUALCOMM Incorporated under one or more of the following United States Patents and/or their counterparts in other nations:

4,901,307	5,490,165	5,056,109	5,504,773	5,101,501
5,506,865	5,109,390	5,511,073	5,228,054	5,535,239
5,267,261	5,544,196	5,267,262	5,568,483	5,337,338
5,600,754	5,414,796	5,657,420	5,416,797	5,659,569
5,710,784	5,778,338			

Bluetooth is a trademark of the Bluetooth SIG, Inc.



The Bluetooth word mark and logos are owned by the Bluetooth SIG, Inc. and any use of such marks by Sharp is under license. Other trademarks and trade names are those of their respective owners.

Powered by Mascot Capsule®/Micro3D Edition™

Mascot Capsule® is a registered trademark of HI Corporation.

©2002-2004 HI Corporation. All rights reserved.

The 2.4 GHz frequency band is used for handset Bluetooth-related functions. Read through the following before use.

The 2.4 GHz frequency band is shared with other industrial, scientific or medical equipment (microwave ovens, etc.), and used at licensed premises radio stations and unlicensed specified low-power radio stations for mobile equipment identification.

- 1 Before using this product, ensure that there is no premises radio station or specified low-power radio station operating for mobile equipment identification.
- 2 Should interference occur between this product and premises radio station for mobile equipment identification, change the frequency immediately, or stop the transmission and contact us for countermeasures (partitioning, etc.).
- 3 For any other issues including interference with specified low-power radio stations for mobile equipment identification, contact us at the following number.

Vodafone Customer Centre, General Information

From a Vodafone handset, call toll free at 157 for General Information.

From landlines, refer to "Customer Service" on **P.16-32**.

- This product operates in the 2.4 GHz frequency band based on FHSS modulation. The operation range is 10 m or less.

2.4FH1



This product employs Macromedia® Flash Lite™ technology developed by Macromedia, Inc.

Copyright © 1995-2004 Macromedia, Inc. All rights reserved. Macromedia, Flash, Flash Lite, Macromedia Flash and Macromedia Flash Lite are either registered trademarks or trademarks of Macromedia, Inc. in the United States and/or other countries.



macromedia
FLASH PLAYER

CP8 PATENT

FCC Declaration of Conformity

This device complies with part 15 of the FCC Rules. Operation is subject to the following two conditions:
(1) This device may not cause harmful interference, and (2) this device must accept any interference received, including interference that may cause undesired operation.

Responsible Party:

SHARP ELECTRONICS CORPORATION
Sharp Plaza, Mahwah, New Jersey 07430
TEL: 1-800-BE-SHARP

Tested To Comply With FCC Standards
FOR HOME OR OFFICE USE



FCC Notice

The handset may cause TV or radio interference if used in close proximity to receiving equipment. The FCC can require you to stop using the handset if such interference cannot be eliminated.

Information to User

This equipment has been tested and found to comply with the limits of a Class B digital device, pursuant to Part 15 of the FCC Rules. These limits are designed to provide reasonable protection against harmful interference in a residential installation. This equipment generates, uses and can radiate radio frequency energy and, if not installed and used in accordance with the instructions, may cause harmful interference to radio communications.

However, there is no guarantee that interference will not occur in a particular installation; if this equipment does cause harmful interference to radio or television reception, which can be determined by turning the equipment off and on, the user is encouraged to try to correct the interference by one or more of the following measures:

1. Reorient/relocate the receiving aerial.
2. Increase the separation between the equipment and receiver.
3. Connect the equipment into an outlet on a circuit different from that to which the receiver is connected.
4. Consult the dealer or an experienced radio/TV technician for help.

Caution: Changes or modifications not expressly approved by the manufacturer responsible for compliance could void the user's authority to operate the equipment.

FCC RF Exposure Information

Your handset is a radio transmitter and receiver. It is designed and manufactured not to exceed the emission limits for exposure to radio frequency (RF) energy set by the Federal Communications Commission of the U.S. Government.

The guidelines are based on standards that were developed by independent scientific organisations through periodic and thorough evaluation of scientific studies. The standards include a substantial safety margin designed to assure the safety of all persons, regardless of age and health.

The exposure standard for wireless handsets employs a unit of measurement known as the Specific Absorption Rate, or SAR. The SAR limit set by the FCC is 1.6W/kg.

The tests are performed in positions and locations (e.g., at the ear and worn on the body) as required by the FCC for each model. The highest SAR value for this model handset when tested for use at the ear is 0.549W/kg and when worn on the body, as described in this user guide, is 0.326W/kg. Body- worn Operation; This device was tested for typical body-worn operations with the back of the handset kept 1.5cm from the body. To maintain compliance with FCC RF exposure requirements, use accessories that maintain a 1.5cm separation distance between the user's body and the back of the handset. The use of beltclips, holsters and similar accessories should not contain metallic components in its assembly.

The use of accessories that do not satisfy these requirements may not comply with FCC RF exposure requirements, and should be avoided.

The FCC has granted an Equipment Authorisation for this model handset with all reported SAR levels evaluated as in compliance with the FCC RF emission guidelines. SAR information on this model handset is on file with the FCC and can be found under the Display Grant section of <http://www.fcc.gov/oet/fccid> after searching on FCC ID APYHRO00039.

Additional information on Specific Absorption Rates (SAR) can be found on the Cellular Telecommunications & Internet Association (CTIA) website at <http://www.phonefacts.net>.

European RF Exposure Information

Your handset has been designed, manufactured and tested so as not to exceed the limits for exposure to electromagnetic fields recommended by the Council of the European Union. These limits are part of comprehensive guidelines developed by independent scientific organisations. The guidelines include a substantial safety margin designed to assure the safety of the handset user and others and to take into account variations in age and health, individual sensitivities and environmental conditions. European standards provide for the amount of radio frequency electromagnetic energy absorbed by the body when using a handset to be measured by reference to the Specific Absorption Rate (SAR). The SAR limit for the general public is currently 2W/kg averaged over 10g of body tissue. Your handset SAR value is 0.686W/kg.

This has been tested to ensure that this limit is not exceeded even when the handset is operating at its highest certified power. In use however your handset may operate at less than full power because it is designed to use only sufficient power to communicate with the network.

Declaration of Conformity

We of

Sharp Telecommunications of Europe Ltd
 Azure House
 Bagshot Road
 Bracknell
 Berkshire
 RG12 7QY

Declare under sole responsibility that the product:

Model: **80ZSH**

Describes: **GSM 900-GSM 1800 PCS 1900 Tn Band Dual Mode WCDMA Cellular Telephones, Bluetooth enabled**

To which this declaration relates, is in conformity with the following standards and/or other normative documents:

- ETSI EN301511
- ETSI EN301908-1
- ETSI EN301908-2
- ETSI EN301489-1
- ETSI EN301489-7
- ETSI EN301489-17
- ETSI EN301489-24
- ETSI EN300328-2
- EN60950
- EN50360
- EN50371

We hereby declare that the above named product is in conformance to all the essential requirements of the Directive **1999/5/EC**

The conformity assessment procedure referred to in Article 10 and detailed in Annex [V] of directive 1999/5/EC has been followed related to Articles

- R&TTE Article 3.1 (a) Health and Safety
- R&TTE Article 3.1 (b) EMC
- R&TTE Article 3.2 spectrum Usage

With the involvement of the following Notified Body:

BAIT, Charnournt House, 34 Molesey Road, Walton-on-Thames, KT12 4RQ

Identif(ication) mark: **0168 (Notified Body) CE**

The technical documentation relevant to the above equipment will be held at:

Sharp Telecommunications of Europe Ltd
 Azure House
 Bagshot Road
 Bracknell
 Berkshire
 RG12 7QY

EU Representative: **Clive Ross Bak**

Authorised Person:

Name: **Clive Ross Bak**

Signature: 

Title:

GENERAL MANAGER, 31/08/2004

Date:

IMEI.: 350257 00

Document Control No: STE/BUSINESS/QA/1708

Getting Started

Function & Feature Preview

SD Memory Card is required for items with grey background.

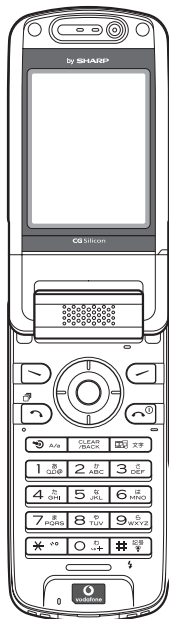

USIM Card

Contains user information. For use with USIM Card compatible Vodafone handsets.

P.1-4

Rotating Display

Change handset Display position to use mobile camera, etc.

P.1-13 - 1-14

Memory Card

Save files to SD Memory Card to expand handset memory or back-up handset files.

P.1-25

International Roaming

Compatible with both W-CDMA and GSM network systems. Use the same number in Japan and abroad.

P.2-14

Manner Mode

Press a single key to mute ringer and activate Message Recorder automatically.

P.2-16

Kanji Conversion

Use Predictive or Previous Usage to reduce keystrokes when entering Japanese text.

P.3-6, P.3-12 - 3-13

Phone Book

Save up to 500 entries (with up to three phone numbers and mail addresses each) on handset and more on USIM Card.

P.4-2

TV Call

Place or receive calls with voice and video.

P.5-2

Camera

Capture still and video images.

P.6-2

Media Player

Play downloaded music and video images as well as captured video images.

P.7-2

Data Folder

Save and manage a variety of handset files.

P.8-2

Bluetooth

Exchange files and information with other handsets, etc. wirelessly via Bluetooth.

P.9-3

Infrared

Exchange files and information with other handsets, etc. wirelessly via Infrared.

P.9-9

Display

Set Wallpaper, System Graphics and Fonts to customise your handset.

P.10-4

Display Language

Set handset menus, etc. to appear in English or Japanese.

P.10-5

Calendar & Tasks

Organise daily, weekly, and monthly events.

P.11-2

Voice Recorder

Record/play voice. Send recorded voice via MMS.

P.11-9

Barcodes

Scan UPC and QR Codes or create QR Codes from Phone Book entries, etc.

P.11-11

Electronic Books

Read E-Books (XPDF format) saved on SD Memory Card.

P.11-24

Vodafone live!

Exchange SMS/MMS messages, access the Mobile Internet and download V-applications.

P.13-2

**Optional Services****Call Forwarding**

Forward incoming calls to a specified number.

P.12-2

Voice Mail

Forward incoming calls to Voice Mail Centre.

P.12-4

Call Waiting

Answer an incoming call during a call.

P.12-5

Conference Call

Switch between multiple lines or talk on all simultaneously.

P.12-6

Call Barring

Restrict incoming/outgoing calls.

P.12-7

Caller ID

Show or hide your number when placing calls.

P.12-10

USIM Card

General Information & Precautions

Vodafone Global Standard USIM Card is an IC card containing customer information such as handset number. USIM Card must be inserted before using a USIM Card compatible handset. Without USIM Card, calls, messaging, Web and other Network-related services are not available.

- Save Phone Book on USIM Card (see **P.4-2**).
- Use USIM Card files with other compatible Vodafone handsets.
- Do not apply excessive force to insert/remove USIM Card.
- Do not insert USIM Card into any other IC card device. Vodafone is not liable for resulting damages.
- Keep the USIM Card IC chip clean.
- Use a dry, soft cloth to clean the USIM Card.
- Do not attach labels to USIM Card. Malfunction may result.

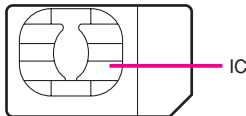

USIM Card

If Handset is Dropped or Subjected to Shocks

USIM Card may not be recognised. In such cases, handset may automatically restart. This is not a malfunction. If **Insert SIM Card** appears, check that USIM Card is properly inserted and restart handset.

Important

- USIM Card is the property of Vodafone.
- USIM Card will be reissued for a fee if lost or damaged.
- Return USIM Card to Vodafone upon subscription termination.
- Returned USIM Cards are recycled.
- USIM Card specifications are subject to change without prior notice.
- Back-up USIM Card files. Vodafone is not liable for lost files.

Inserting & Removing USIM Card

Inserting

1 Remove battery (see P.1-21)

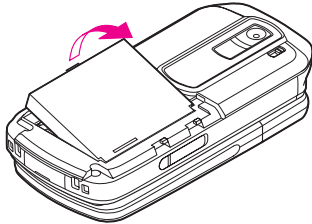

- Note** ▶
- Do not force USIM Card into handset. Damage may result.
 - Avoid touching USIM Card IC chip. May hinder performance.

2 Slide in USIM Card with IC chip facing down

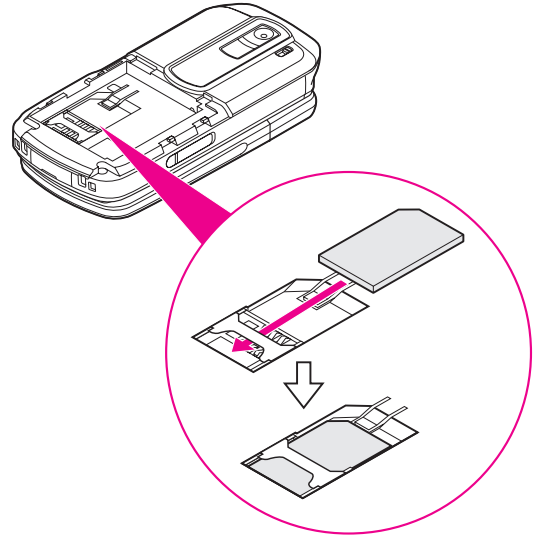

3 Insert battery

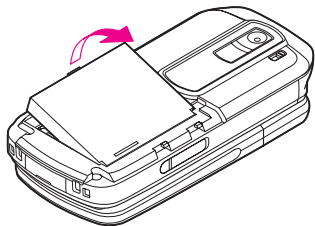
Removing**1 Remove battery (see P.1-21)**

- Note** ▶
- Do not force USIM Card out of handset. Damage may result.
 - Be careful not to lose removed USIM Card.
 - Avoid touching USIM Card IC chip. May hinder performance. In such cases, **Insert SIM Card** may appear or handset may automatically restart. This is not a malfunction. Avoid touching USIM Card terminals as well.

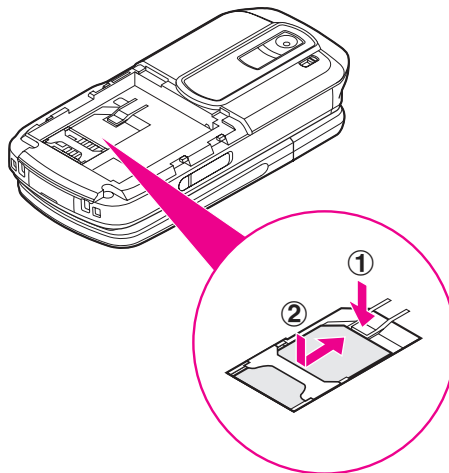
2 Press down the tab and slide out USIM Card as shown**3 Insert battery**

USIM PINs

There are two Security Codes for USIM Card: PIN1 and PIN2.

PIN1

A 4-digit to 8-digit Security Code to prevent unauthorised use of Vodafone handset.

- PIN1 is **9999** by default.
- To change PIN1, see **P.10-10**.
- When **Switch On/Off** in **PIN Entry** is **On** (see **P.10-10**), PIN1 is required every time handset is turned on (with USIM Card inserted).

PIN2

Required to clear Call Costs and to set Max Cost.

- PIN2 is **9999** by default.
- To change PIN2, see **P.10-10**.

PIN Lock & PUK Code

PIN1 Lock or PIN2 Lock is activated if PIN1 or PIN2 is incorrectly entered three times consecutively. Cancel PIN1 Lock by entering the Personal Unblocking Key (PUK Code). For information on PUK Code, contact Vodafone Customer Centre, General Information (see **P.16-32**).

- Note** ▶
- If PUK Code is incorrectly entered ten times, USIM Card is locked and handset is disabled. Write down PUK Code.
 - For procedures required to unlock USIM Card, contact Vodafone Customer Centre, General Information (see **P.16-32**).

Handset Parts & Functions

Handset

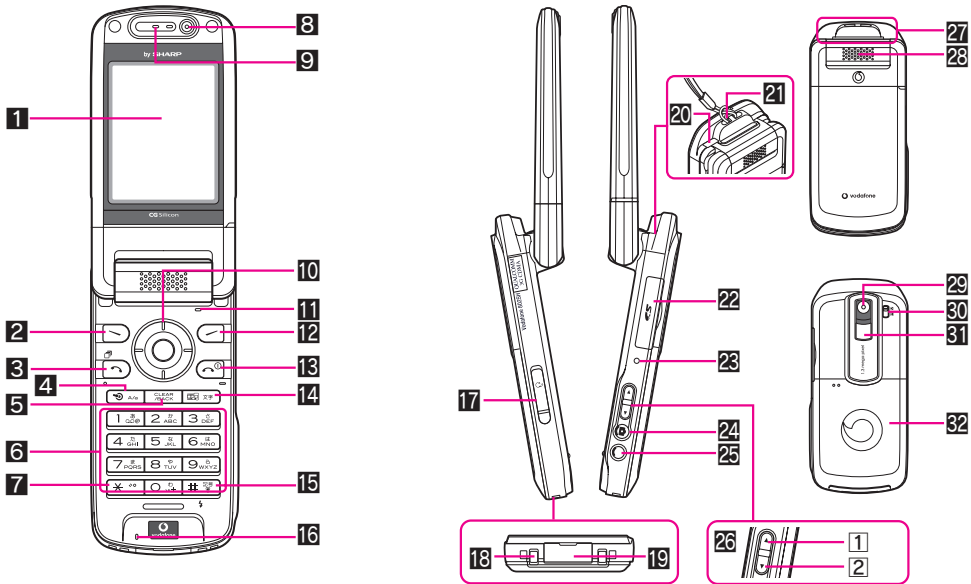

1 Display**2 Left Soft Key**

Open messaging menu or execute Soft Key function/command.

3 Start Key

Initiate/answer calls. Open records of All Calls.

4 Shortcuts & A/a Key

List User Shortcuts, etc. Toggle between upper/lower case roman letters or standard/small hiragana/katakana in text entry windows.

5 Clear/Back Key

Delete entries/return to previous window.

6 Keypad**7 * Key/Keypad Lock**

Press for 1+ seconds to set or release Keypad Lock. In alphanumeric entry, open web/mail address prefixes & suffixes.

8 Internal Camera

Use during TV Call.

9 Earpiece**10 Multi Selector**

Select menu items, move cursor, scroll, etc.

11 Microphone

Use in Viewer position.

12 Right Soft Key

Open Vodafone live! menu or execute Soft Key function/command.

13 Power On/Off Key

Press for 2+ seconds to turn handset power on/off.

14 Multimedia/Text Key

Start Media Player or toggle character types.

15 # Key

- When handset is opened for mobile camera (clamshell open), turn Mobile Light on/off. In text entry windows, toggle through Symbol & Pictograph lists.
- Press for 1+ seconds to activate/cancel Manner mode.

16 Microphone**17 Headphone Connector**

Connect supplied Multi Stereo Headphones, etc.

18 Charger Terminal**19 External Device Connector**

Connect Charger here.

20 Infrared Port

Use for infrared transmissions.

21 Strap Eyelet

Attach straps as shown.

22 Memory Card Slot

Insert SD Memory Card here.

23 Small Light

Illuminates red while charging.

24 Shutter Key

In Viewer position, press to open selected menu items or execute functions. Press for 1+ seconds to activate mobile camera (for more information, see **P.6-4**).

25 Clear Key

Press for 1+ seconds to activate Pen Light. In Viewer position, press to cancel the current operation or return to the previous window, etc. For mobile camera keys, see **P.6-4**.

26 Zoom/Select Key

- In Viewer position, press to select menu items or to move cursor. For mobile camera keys, see **P.6-4**.

1 Move cursor down or right.

2 Move cursor up or left.

27 Internal Antenna**28 Speaker****29 External Camera; lens cover**

Capture still and video images.

30 Portrait/Macro Selector**31 Mobile Light**

Flashes for incoming calls/mail. Serves as a strobe or Pen Light.





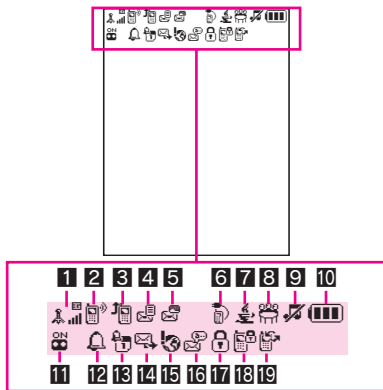























32 Battery Cover**Note ▶ Internal Antenna**

- 802SH has no external antenna. Handset transmits and receives signals via Internal Antenna.
- Do not cover or place stickers, etc. over the area containing Internal Antenna. Voice quality is affected depending on how and where handset is used.
- For better signal in Standby, close handset (clamshell closed: see **P.1-13**). For better voice quality, talk with handset open (clamshell open: see **P.1-13**).



- 1** **Signal Strength** (Strong Moderate Low Weak **OUT Out-of-Range**)
- Off Line Mode**
- 3G**
- GSM (GPRS Available)**
- appears red in 3G and grey in GSM.

- 2** **SD Memory Card Status**
 - Incoming Voice Call**
 - Voice Call in Progress**
 - TV Call in Progress**
 - Line Active (Server or Web Transmission)**
- 3** **Call Forwarding or Voice Mail**
 - SSL**
 - appears when Call Forwarding or Voice Mail is set for all Voice Calls.
- 4** **SMS**
- 5** **MMS**
 - Receiving Mail**
 - Sending Mail**
 - Memory Full**
- 6** **USB Transmission Ready**
 - (red) Infrared Connection in Progress**
 - Infrared Transmission in Progress**
 - Bluetooth Transmission Ready**
 - Bluetooth Transmission in Progress**
 - Bluetooth Talk in Progress**
- 7** **Active V-application**
 - (grey) Paused V-application**
 - Music Player Active**

- 8  Meeting Mode
- 9  Activity Mode
- 10  Car Mode
- 11  Headset Mode
- 12  Manner Mode
- 13  Silent
 - 14  Increasing Volume
 - 15  Vibration
 - 16  Silent & Vibration
 - 17  Loudspeaker
 - 18  Microphone Mute
- 19  Battery Strength
 - 20  Pen Light
 - 21  and  flash when Pen Light is in use.
- 22  Message Recorder Active
 - 23  Message
 - 24  (green) Message Recorder Active
 - 25  (black) Message Recorder Cancelled
- 26  Alarm Set
- 27  Schedule (Reminder On)
 - 28  Schedule (Reminder Off)
- 29  Message Delivery Failure
- 30  Auto Delivery Info
- 31  New Voice Mail
- 32  Secret Mode Active
- 33  Phone Lock Active
 - 34  Keypad Lock Active
- 35  (grey) Infrared Transmission Ready

Display Positions & Keys

802SH features a rotating Display. Select from four positions.

In this manual, most operations are described with handset open (clamshell open). However, mobile camera operations (see **P.6-2**) are described with Display in Viewer position.

Display Positions

Hold handset with both hands when changing Display position.

Clamshell Closed

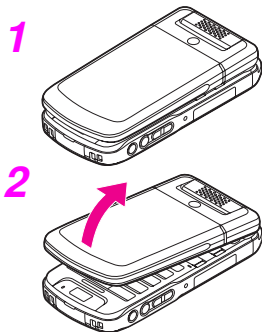

Handset is closed with Display facing inward.

Keep this position when not in use.

Tip ► Place or answer calls with handset open (clamshell open) or in Viewer position.

Clamshell Open

3 Open handset

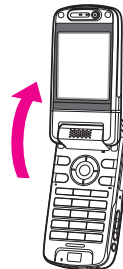

Handset is open with Display facing inward.

Place or answer calls, or enter text.

Self Portrait Position

4 Rotate Display 180 degrees clockwise

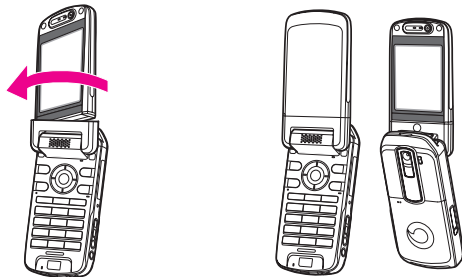

Handset is open with Display facing outward.

Capture a self portrait.



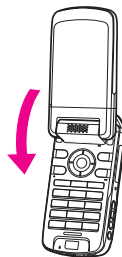

- Note** ▶
- Place or answer calls with handset open (clamshell open) or in Viewer position.
 - Do not rotate Display anticlockwise when changing to Self Portrait position.

Viewer Position

6 Close handset



Handset is closed with Display facing outward.

- Use this position for mobile camera (see P.6-2) or checking images on Display (see P.6-18).
- Use , ,  or  to perform basic operations as with clamshell open.





- Note** ▶ Do not carry handset with Display in Viewer position. Damage may result.

Key Press Methods

Multiple functions are assigned to some keys, distinguished by the following ways to press.





Press	Press once softly	Long Press	Press for 1+ seconds
--------------	-------------------	-------------------	----------------------

Side Key Assignments (Viewer)

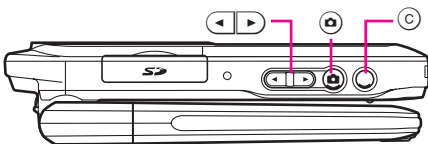
When handset is in Viewer position, use , ,  or .













In Standby



	Long Press	Activate mobile camera
	Press	Open Main Menu
	Long Press	Illuminate Pen Light
	Press	Adjust Earpiece Volume
		

During Operations

The keys correspond as follows. (Not applicable during calls or incoming calls, or while mobile camera or V-application is active.)

Viewer Position		Clamshell Open
	Long Press	
	Press	
	Long Press	
	Press	
	Press	 or 
	Press	 or 

*Depends on content.

Tip ▶ Use the corresponding keys in Viewer position.

Battery & Charger

Getting Started

Charge a new battery before use or after a period of disuse.

Battery Life

- Do not use or store battery at extreme temperatures. May shorten battery life.
 - Ideal working temperature is between 5°C - 35°C.
- Use specified Charger only. Battery may deteriorate, overheat or ignite.
- Replace battery if operating time is noticeably shorter than normal.

Charging

- Do not use Charger for other purposes.
- Battery may short-circuit, overheat or burst from contact with metal objects.
- Small Light illuminates red while charging. (It may take a while for the light to illuminate when handset power is off.)
- Charging takes approximately 135 minutes (with handset power off).
 - **Charging time may vary by ambient temperature.**
- Charger and battery may become warm during charging.
- Move Charger away from home TVs or radios if interference occurs.

Precautions

- Use a dry cotton swab to clean handset, battery and Charger terminals.
- Avoid:
 - Extreme temperatures
 - Humidity, dust and vibration
 - Direct sunlight
- Do not leave battery uncharged. Charge at least once every six months.
- Use a case when carrying battery separately.

Tip ►

- Battery must be inside handset to charge.
- Handset will charge with power on.  flashes and stays on when complete.
- **Handset will charge while open.**

Estimated Hours of Use (fully charged battery)

Continuous Call Time	150 minutes (3G) or 240 minutes (GSM)
Continuous Standby Time	240 hours (3G) or 250 hours (GSM)
Continuous Operating Time	4.5 hours
Continuous Playback Time	7 hours
Continuous TV Call Time	90 minutes

Above values are calculated with Backlight Brightness set to **Level: 2** (default).

- Continuous Call Time is an average measured with a new, fully charged battery, with stable signals.
- Continuous Standby Time is an average measured with a new, fully charged battery, with handset closed (clamshell closed) without calls or operations, in Standby with stable signals. Standby Time may be less than half this value if handset is out-of-range or signal is weak. Standby Time may vary by environment (battery status, temperature, etc.).
- Continuous Operating Time is measured with handset being operated without calls.
- Continuous Playback Time is measured with sound/music being played back in Off Line Mode.
- The above values (Battery Time) are nominal values, measured under stable signal conditions.

Battery Time

Battery Time may shorten when handset is used in poor conditions:

- **Poor Usage Conditions**
 - Extreme temperatures (use within a range of 5°C - 35°C)
 - Dirty handset, battery or Charger terminals (charging may be hampered)
 - Weak signals or out-of-range
- **Operation**
 - V-application is active
 - Repeated mobile camera use or barcode scanning
 - Frequent use of Mobile Light
 - Playing video images
 - Frequent use of Pen Light
 - Continuous Keypad use (Backlight stays on for long periods)
 - Use of Music Player/Voice Recorder
 - Frequent infrared transfers
 - Frequent opening/closing of handset
- **Setting**
 - Display Saving start time or Backlight time is set longer
 - Backlight is set brighter

Extend Battery Time

Adjust Display Backlight settings to reduce power consumption (see P.10-6).

When Battery Runs Out

A message appears and short beeps sound. Handset shuts down after 20 seconds unless charged. Press  to stop short beeps. (Short beeps do not sound in Manner mode.) If battery runs out while talking, short beeps sound every five seconds. After 20 seconds, the call ends and handset shuts down.

Battery Disposal

Do not dispose of exhausted batteries with ordinary refuse. Tape over battery terminals before disposal, or bring them to a Vodafone shop. Follow local regulations regarding battery disposal.

Battery Strength



When battery runs out () **Recharge battery.** appears and short beeps sound. Handset shuts down after 20 seconds.

Indicator

Battery Strength indicator varies as shown.
Charge or replace when level is low.

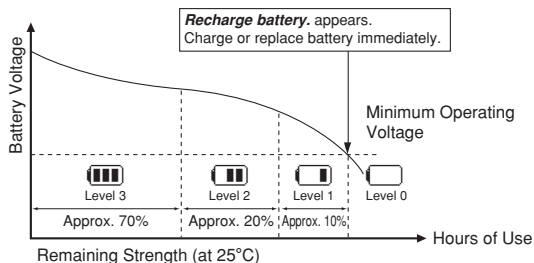

Battery Strength & Environment

At low temperatures, battery is consumed faster.
At high temperatures, battery lasts longer.

- Note**
- Battery Strength indicator is for reference only.
 - At Level 1, some functions including Music Player, Voice Recorder, Video Camera, etc. do not operate (see P.7-3, P.11-9, P.6-10).

Small Light & Battery Strength Indicator

Handset Power On

Small Light	Indicator (■■■■)	Conditions
Off	Flashes	Ambient temperature is outside the range of 5°C - 35°C, or battery has run out
Flashes red	Flashes	Battery life has ended, or battery defect
Illuminates red	Flashes	Charging
Off	Illuminates	Charging completed/Standby

Handset Power Off

Small Light	Indicator (■■■■)	Conditions
Off	Off	Ambient temperature is outside the range of 5°C - 35°C, or battery has run out
Flashes red	Off	Battery life has ended, or battery defect
Illuminates red	Off	Charging
Off	Off	Charging completed

Installing & Removing Battery

Inserting

1 Press down and slide cover as shown

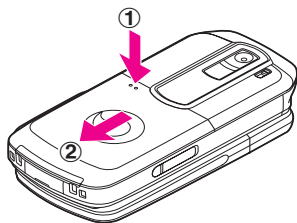

2 Lift and remove cover as shown

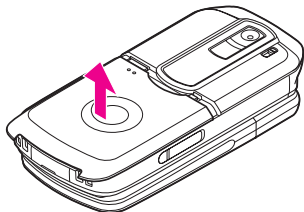

3 Insert battery

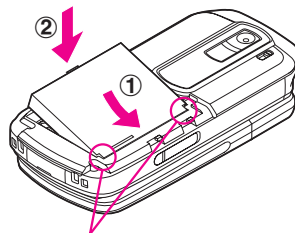

- With printed side up, fit tabs into battery cavity slots.

4 Close cover

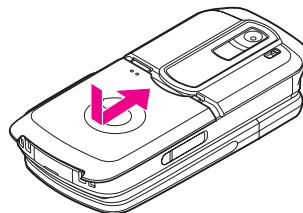

- Position and slide cover as shown until it stops.

Tip ▶ Lithium-ion battery is used for this product. Lithium-ion battery is a recyclable resource.

- To recycle a used battery, take it to any shop displaying the symbol shown to the right.
- To avoid fire or electric shock, do not:
 - Short-circuit batteries
 - Disassemble batteries



Removing

1 Press down and slide cover as shown

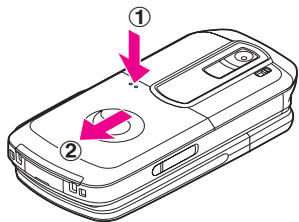

2 Lift and remove cover as shown

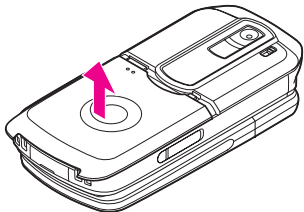

3 Remove battery

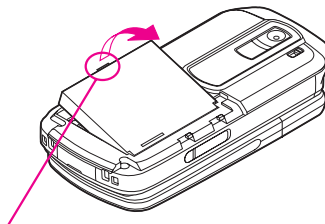

• Remove battery as shown.

Note ▶

- Turn handset power off before removing battery.
- Do not remove battery immediately after saving files, sending messages, etc.

AC Charger

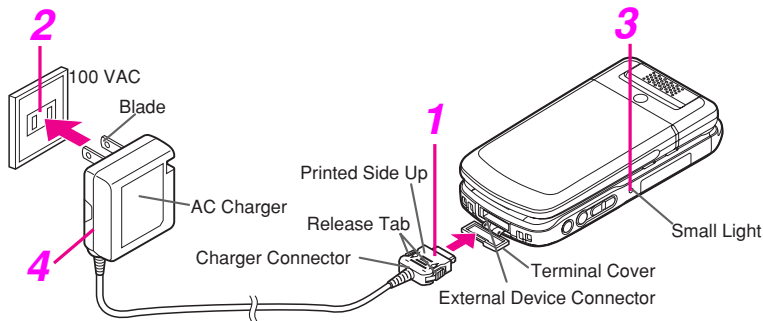

Use specified Charger only.

1 Open Terminal Cover and insert Charger connector until it clicks

2 Plug in Charger

- Charging starts and Small Light illuminates red (see P.1-19).
- **Extend blades. Fold back when not in use.**

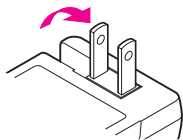

3 Charging is complete when light goes out

- Charging takes approximately 135 minutes.

4 After Charging

Unplug Charger from outlet, then handset

- Squeeze release tabs and pull connector straight out.
- Cap Terminal Cover.

Note ▶

- Do not pull, bend or twist AC Charger cord.
- AC Charger is compatible with 100 - 240 VAC household currents.
- Vodafone is not liable for problems caused by charging handset abroad.

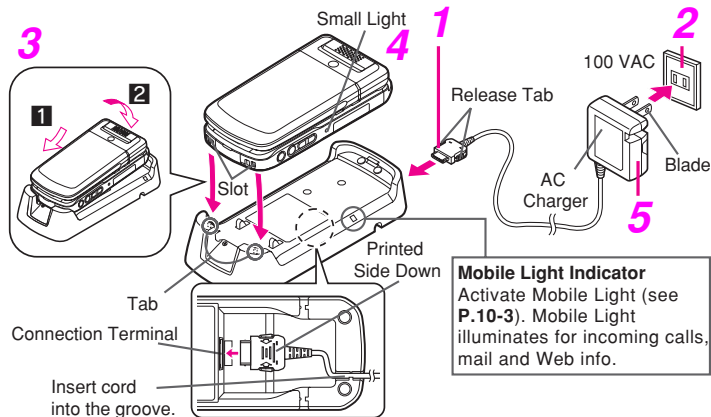

Use specified Charger and Desktop Holder only.

1 Insert Charger connector into Desktop Holder until it clicks

- Connection Terminal is on the back of Desktop Holder.

2 Plug in Charger

- Extend blades. Fold back when not in use.

3 Gently insert handset into Desktop Holder

- Fit tabs into slots as shown in **1** and push handset as indicated in **2** until it clicks.
- Charging starts and Small Light illuminates red (see P.1-19).

4 Charging is complete when light goes out

- Charging takes approximately 135 minutes.

5 After Charging

Unplug Charger from outlet and remove handset

In-Car Charger

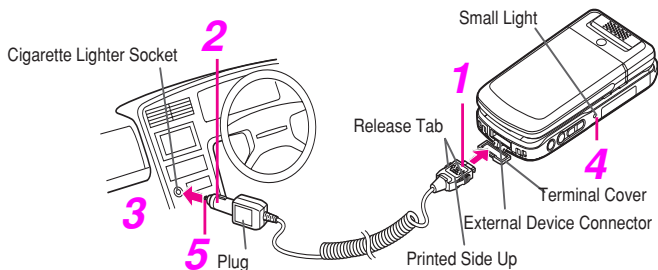

1 Open Terminal Cover and insert Charger connector until it clicks

2 Plug in Charger

3 Start car engine

- Charging starts and Small Light illuminates red (see P.1-19).

4 Charging is complete when light goes out

- Charging takes approximately 145 minutes.

5 After Charging

Unplug Charger from socket, then handset

- Squeeze release tabs and pull connector straight out.
- Cap Terminal Cover.

Note ▶

- Use In-Car Charger inside vehicles with a negative earth only.
- Disconnect Charger before leaving vehicle to prevent charging with engine off.
- Do not use In-Car Charger with Desktop Holder.
- Avoid charging battery inside extremely hot vehicles.

Tip ▶

- For more information, see In-Car Charger manual.
- Use optional In-Car Holder to secure handset.

Memory Card

- An SD Memory Card is not included. Purchase SD Memory Card separately to use Memory Card-related functions.
- Format a new SD Memory Card for use with 802SH (see **P.10-13**).
- To learn how to save a particular file to an SD Memory Card, refer to that section of the manual.

Precautions

- 802SH is compatible with SD Memory Card and SD-ROM Card.
- The manufacturer recommends the use of 8, 16, 32, 64, 128, 256 or 512 MB or 1 GB cards.
- For optimum use of Memory Card-related functions, SD Memory Cards with 16 MB or more capacity are recommended.
- To lower the chance of handset malfunction please use only recommended SD Memory Card sizes.
- Turn handset power off before inserting or removing an SD Memory Card.
- Do not peel off the label on SD Memory Card. Doing so may damage the card or result in lost information.
- Do not place new labels or stickers on SD Memory Card. These items may affect card performance or result in lost information.
- Use an oil-based felt pen to write on SD Memory Card. Using a pencil or ballpoint pen may damage the card or result in lost information.
- Never disassemble or modify an SD Memory Card.
- Do not expose SD Memory Card to strong impacts, pressure or liquids.
- Do not touch SD Memory Card terminals or expose them to metal objects.
- Do not expose SD Memory Card to direct sunlight or excessive heat (e.g. inside vehicles, etc.).
- Keep an SD Memory Card away from dust or high humidity.
- Do not use in the presence of corrosive gases.
- Avoid heat sources and do not dispose of in fire.
- An SD Memory Card is a consumable item. Card performance deteriorates with usage, eventually becoming unusable and needs to be replaced.

Note ▶ Vodafone is not liable for any damages resulting from accidental loss/alteration of information. Please keep a separate record of Phone Book contents, etc.

Inserting & Removing SD Memory Card

Inserting

Turn handset power off.

1 Open cover

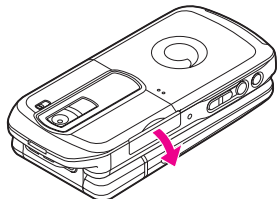

2 Insert card until it clicks

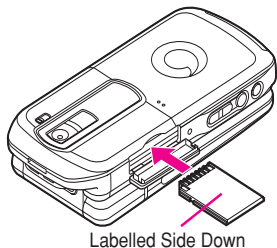

3 Close cover

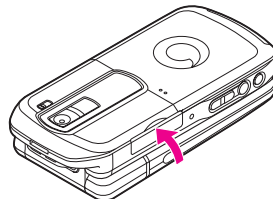

Write Protection Switch

Set Write Protection Switch to LOCK to prevent accidental erasure or overwriting. For more information, see SD Memory Card manual.

Note ▶ Do not insert other objects into Memory Card Slot. Damage may result.

Removing

Turn handset power off.

1 Open cover and lightly push down on card

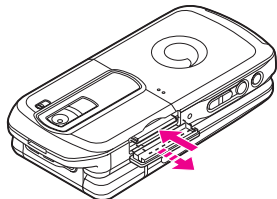

- With a light push, the card pops out.

2 Remove card

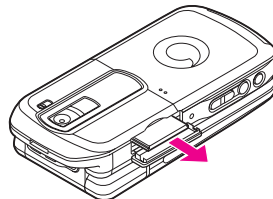



- Slide the card straight out and close cover.

Note ▶ Never remove SD Memory Card or battery while files are being accessed. Damage to handset/card may result.

Tip ▶ Insert an SD Memory Card and turn handset power on. Standby appears. Memory Card load times vary depending on card size and the amount of information saved.

Memory Card Indicator

When an SD Memory Card is inserted into handset, Memory Card indicator appears at the top of Display. Memory Card indicator lights/flashes when in use, etc.

	SD Memory Card inserted
	Accessing files
	Write protection enabled

Handset Power On/Off

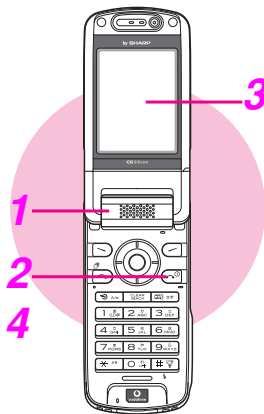

1 Open handset (clamshell open)

2 Press  for 2+ seconds

3

3 Backlight illuminates and Power On Graphics appear

After graphics, handset is in Standby.

4 Turning Off

Press  for 2+ seconds

Power Off Graphics appear and handset shuts down.

Handset Clock Settings

If date and time have not been set, **Time & Date is not set. Set now?** appears after Power On Graphics.

Press  **Yes** ➔ Set Time Zone (see P.10-7) ➔ Set date and time (see P.10-7)

Press  **No** ➔ Standby appears without date and time

- Note** ▶
- Set the current date and time before using handset functions (see P.10-7).
 - USIM Card data is read after turning power on. Signal strength indicator may take some time to appear. It may take longer when turning power on for the first time.
 - If handset is dropped or subjected to shocks, USIM Card may not be recognised. In such cases, handset may automatically restart. This is not a malfunction.
 - **Insert SIM Card** appears when USIM Card is not inserted.
 - If **Insert SIM Card** appears even if USIM Card is inserted, check that the card is properly inserted and that the IC chip is clean, then restart handset.

- Tip** ▶
- Handset receives incoming mail or Web information while closed.
 - Display shuts down after a period of inactivity.

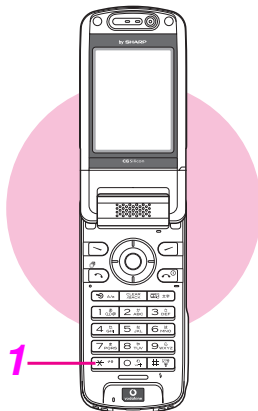

Keypad Lock

Use Keypad Lock to lock handset keys and prevent accidental activation of functions or operations.

Activate

1 Press ***^{oo}** for 1+ seconds

 appears and Keypad Lock is set.

Cancel

1 In Standby, press ***^{oo}** for 1+ seconds

 disappears.

Tip ► When Keypad Lock is Active





- Incoming calls temporarily cancel Keypad Lock. To answer calls, press keys for Any Key Answer (see P.2-5). Keypad Lock reactivates after the calls end.
- Handset power does not turn off even if  is pressed for 2+ seconds.

Pen Light

Use handset as a flashlight.

Pen Light On/Off Turn Pen Light on and off

In Standby, press  (Long Press) ► Pen Light illuminates

-  To change illumination colour, press  or  while on.
-  Press  to turn off.

Note ► Do not point Pen Light at people's faces or look into the light yourself.

Handset Menus

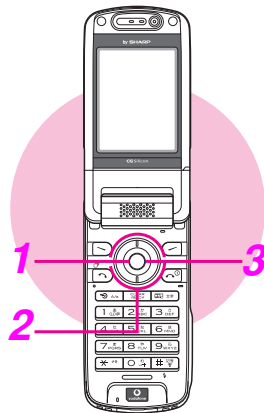

Main Menu

Access functions/operations from Main Menu.

1 Press

Main Menu opens.

In Viewer position, press .

2 Use to select an item

In Viewer position, press or .

3 Press

Sub Menu opens (see P.16-2).

In Viewer position, press .

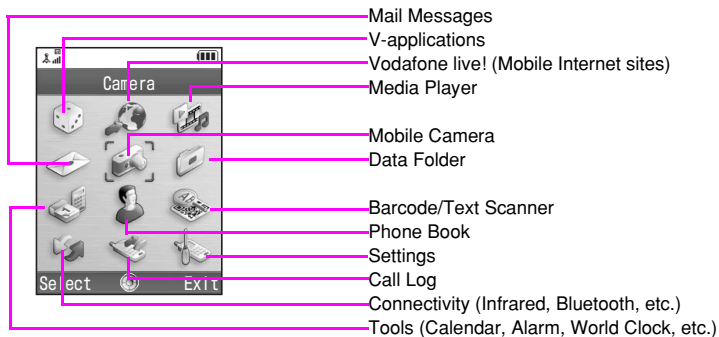

■ Main Menu Items



Soft Keys

Soft Key functions appear at the bottom of Display.







- Press  to select or execute the assigned function or operation.
- Press  to select or execute the assigned function or operation.
- Press  to select or execute the assigned function or operation.

Soft Key Assignments (Viewer)

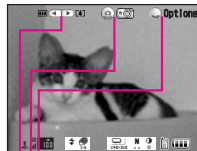
Soft Key functions appear at the top of Display when mobile camera is active.

Mobile Camera



- Press  to select or execute the assigned function or operation.
- Press  to select or execute the assigned function or operation.
- Press  to select or execute the assigned function or operation.
- Press  to select or execute the assigned function or operation.

Other Windows



User Shortcuts

Create shortcuts to functions and files.

Default shortcuts:

- Dialed Numbers, Received Calls, Calendar, Calculator and Voice Recorder

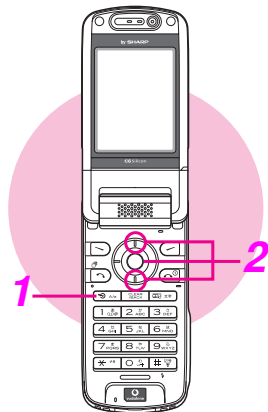

Using Shortcuts

1 Press

2 Select a function and press

Assign Change default shortcuts

Press → Select an item → Press **Options** → Select **Assign** → Press → Select new item → Press

Move Change the order of items

Press → Select an item → Press **Options** → Select **Move** → Press → Use to move position → Press

Set to Default Return to default shortcuts

Press → Press **Options** → Select **Set to Default** → Press → Press **Yes**

Security Codes

Handset Code, Centre Access Code and Network Password are needed for handset use.

Handset Code

9999 or the 4-digit number selected at initial subscription. Handset Code is required to use/change some handset functions.

- ✕ appears when Handset Code is entered.
- If incorrect, **Handset code is incorrect!** appears. Enter correct Handset Code.

Centre Access Code

The 4-digit number in the contract, required to access Voice Mail via landlines, and to subscribe to fee-based information.

Network Password

The 4-digit number selected at initial subscription, required to restrict handset services. If Network Password is incorrectly entered three times, Call Barring settings are locked. To resolve, Network Password and Centre Access Code must be changed. For details, contact Vodafone Customer Centre, General Information (see **P.16-32**).

- Note** ►
- Write down Handset Code, Centre Access Code and Network Password. If lost, contact Vodafone Customer Centre, General Information (see **P.16-32**).
 - Do not reveal Handset Code, Centre Access Code and Network Password. Vodafone is not liable for misuse or damages.

- Tip** ►
- Change Handset Code and Network Password as needed (see **P.10-12**, **P.12-10**).
 - Do not attempt to change Centre Access Code. Contact Vodafone Customer Centre, General Information (see **P.16-32**) for details.

Basic Handset Operations

Initiating a Voice Call (in Japan)

See **P.2-15** for Voice Call from outside Japan and **P.5-3** for TV Call.

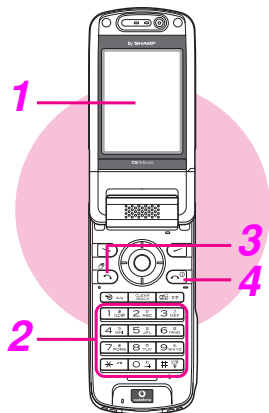

1 Confirm handset is on

- Check signal.
- Handset will not transmit when OUT, or or appears (see **P.16-4**).

2 Enter a phone number

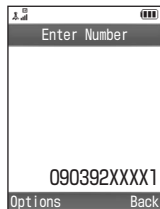

- Include the dialling code even for local numbers.

Sending/Blocking Caller ID

- Press the following keys when placing a call.

■ Send

..... or

■ Block

..... or

Alternatively, press **Options** ➔ Select

Show My ID or **Hide My ID** ➔ Press

3 Confirm the number and press

Correcting Wrong Numbers

- Use or to move cursor and press to delete the digit above the cursor. Press for 1+ seconds to delete the entire number and return to Standby. If you misdial, press to hang up and try again.

Busy Numbers

- Press to end the call and try again later.

4 Press to end call

- Alternatively, close handset (clamshell closed).

- Tip** ▶
- Check Call Timers (see **P.2-12**) and Call Costs (see **P.2-13**).
 - Use Loudspeaker when placing calls (see **P.2-9**).

Supported Network Systems

802SH is compatible with 3G and GSM network systems. See P.2-14 to change system.

Making an International Call

In Standby, enter a phone number ➔ Press ➔ **Options** ➔ **Select Country Code** ➔ Press ➔ **Select a country** ➔ Press twice ➔ **Select Japan** ➔ Press ➔ Press

When calling Vodafone handsets, country code is not required.

Note ➤ Do not cover handset microphone while talking.

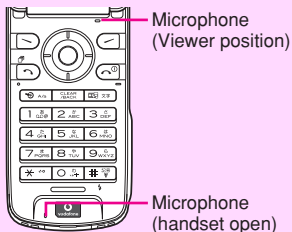

- Avoid covering area over Internal Antenna (see P.1-10 27).
- Voice quality is affected depending on how and where handset is used.
- For better voice quality, talk with handset open (clamshell open).

Viewer Position

Place calls with Display in Viewer position

■ Save the number to Phone Book first (see P.4-2).

Press ➔ **Select Phone Book** ➔ Press ➔ **Select Phone Book List** ➔ Press ➔ **Open a Phone Book entry** (see P.4-9) ➔ Press **Options** ➔ **Select Call** ➔ Press

■ Press to end the call.

- In Viewer position, hold handset with Viewer in and Earpiece up.



- Side Key Assignments during Calls:

	Open Options menu		Increase volume
	End call		Decrease volume

Hold

Hold tone sounds and each other's voice is not heard

■ Subscribe to Call Waiting (see P.12-5) or Conference Call (see P.12-6).

During a call, press **Options** ➔ **Select Hold** ➔ Press

■ To cancel, press ➔ **Select Retrieve** ➔ Press

Mute Microphone

Mute your handset microphone
Other party's voice can be heard

During a call, press **Options** ➔ **Select Mute Microphone** ➔ Press

■ To cancel, press **Options** ➔ **Select Unmute Mic.** ➔ Press

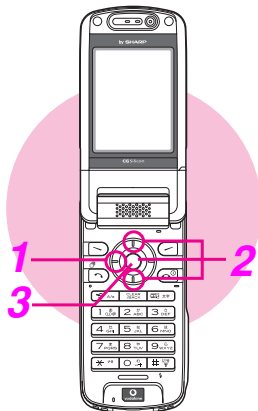

Redial

Up to 10 recently dialed numbers are saved in Dialed Numbers. Place calls from Dialed Numbers.

1 Press

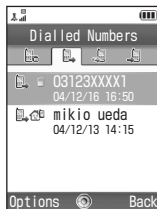

2 Select a record and press

3 Press

Number is dialed.

Dialed numbers appear with date and time.

Name appears if saved in Phone Book.

- Press or to see more.
- Press to see Missed Calls, Received Calls or All Calls.

- Tip** ▶
- When the same number is dialed more than once, only the last record appears.
 - Records remain even after handset power is turned off.
 - When there are 10 records, oldest records are replaced by new ones. Alternatively, delete records manually (see **P.2-11**).

Incoming Voice Call

See **P.5-3** for incoming TV Call.

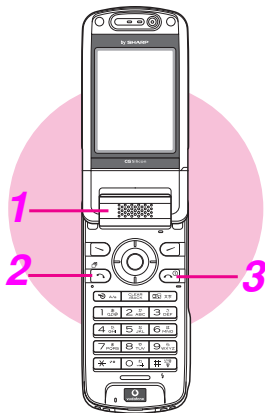

1 When a call arrives, open handset



- Number appears when Caller ID is sent. (Caller's name appears if the number is saved in Phone Book.)

2 Press

3 Press to end call

- Alternatively, close handset (clamshell closed).

Tip ▶ When Any Key Answer is active (see **P.10-3**), press any of the following keys (besides) to answer calls:



Viewer Position Answer calls with Display in Viewer position

When a call arrives, press

- Press to end the call.
- Side Key Assignments for Incoming Calls:

	Answer call		Forward call		Reject call
--	-------------	--	--------------	--	-------------

* Available if **When Busy** (forwarding condition) is set for Call Forwarding or Voice Mail. Calls are rejected when **Off** (see **P.12-3 - 12-4**).

- For operations during calls in Viewer position, see **P.2-3**.

Rejecting or Forwarding Incoming Calls

While handset is ringing/vibrating, use the keys below to reject or forward an incoming call.

☎	Reject a call (see P.2-8)
☎	Forward a call to a preset number. Available if When Busy (forwarding condition) is set for Call Forwarding or Voice Mail. Calls are rejected if Off (see P.12-3 - 12-4).

- Alternatively, activate Message Recorder (see **P.2-20**).
- For operations in Viewer position, see **P.2-5**.

When Message Recorder is Active

Outgoing message plays and recording starts (see **P.2-20**). When Message Recorder is not active, use Quick Recorder (see **P.2-21**).

- Caller incurs charges in either case.

Caller ID

- Phone numbers do not appear when Caller ID is not sent. **Unset ID** appears instead.
- Up to 10 incoming calls details are saved (see **P.2-7**).

Tip ► Change Ringtone volumes, patterns, or Mobile Light colours (see **P.10-2 - 10-3**).

Information

Information window opens for missed calls or Message Recorder messages. Select **Call** and press **⊙** to see details (see **P.2-11**).

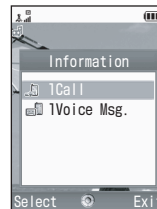

Calling from Received Calls

When Caller ID is sent, numbers appear.

Up to 10 received calls are saved in Received Calls (see **P.2-11**). Place calls to those numbers.

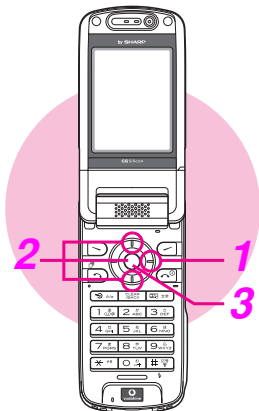

1 Press

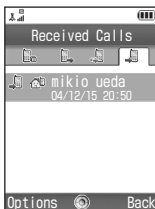

2 Select a record and press

3 Press

Number is dialed.

Received numbers appear with date and time.

Name appears if saved in Phone Book.

- Press or to see more.
- Press to see Dialed Numbers, Missed Calls or All Calls.

- Tip** ▶
- Names in Secret mode entries appear only when handset is in Secret mode.
 - Records remain even after handset power is turned off.
 - When there are 10 records, oldest records are replaced by new ones. Alternatively, delete records manually (see **P.2-11**).

Rejecting Incoming Calls

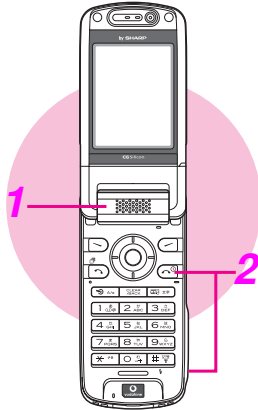

Rejecting a Call

Calls are rejected and saved in Missed Calls.

- 1** When a call arrives, open handset
- 2** While handset is ringing/vibrating, press  or  for 1+ seconds

Voice Mail

Unanswered calls are forwarded to Voice Mail (see P.12-4).

Message Recorder

When Message Recorder is not active, use Quick Recorder (see P.2-21).

Engaged Call Operations

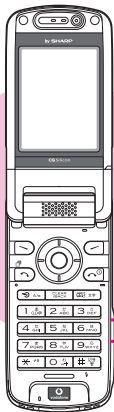

Earpiece Volume

Adjust Earpiece Volume (5 levels). Earpiece Volume is **Level:3** by default.

1 During a call, press ◀ or ▶

2 Press ◀ (up) or ▶ (down) to adjust volume level

Each press changes volume.

- Volume level remains as set even after handset power is turned off.

Loudspeaker

Use Loudspeaker for handsfree conversations.

During a call, press [Options] ➔ **Select Loudspeaker On** ➔ **Press** [Enter]

- To cancel, press [Options] ➔ **Select Loudspeaker Off** ➔ **Press** [Enter]

Touch Tone

During a call, press Keypad ([Call] - [End Call], [*] or [#])

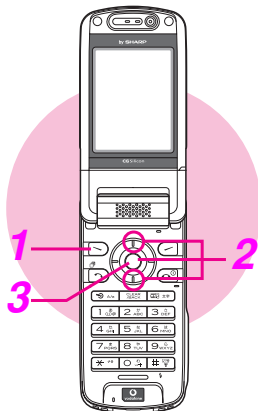

Voice Memo

1 During a call, press **Options**

2 Select **Record** and press **Record**
Recording starts.

3 Press to stop

- Alternatively, end call to stop.
- Recordings remain even after handset power is turned off.

Play

Play Voice Memos

Main Menu ► *Call Log* ► *Message Recorder*

Select **Play** ► Press

To delete, press **Options** while message is playing ► Select **Delete** ► Press ► Press **Yes**

Other Engaged Call Operations

During a call, press **Options**.

Phone Book List	Call another number saved in Phone Book
Messages	Create a new message or check received/sent/draft messages
Dial New Number	Call another number
Disable/Enable DTMF	Disable/enable sending Touch Tones during a call

Call History

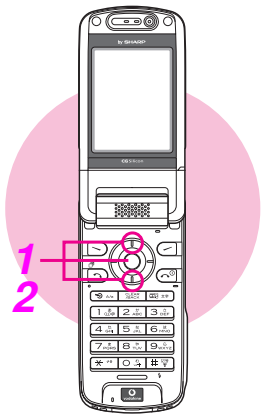

Open the following records:

All Calls	All received, missed or dialled calls
Dialled Numbers	All outgoing calls
Missed Calls	Unanswered calls
Received Calls	Answered calls

Make calls or send messages from call history.

1 Press .
All Calls appears.
Press to see others.

2 Select a record and press .
Record details appear.
To initiate a Voice Call, press .
To initiate a TV Call, press **Options** →
Select **TV Call** → Press

Delete Delete selected call history records

Select a record → Press **Options** → Select **Delete** → Press → Press **Yes**

Call History Options

Open call history and press **Options**.

Save Number	Save the number to Phone Book
Create Message	Compose a new message

Call Time

Check estimated call time of the most recent call (Last Call Time) and the total call time (All Calls Time).
Check call time for Dialed Calls or Received Calls.

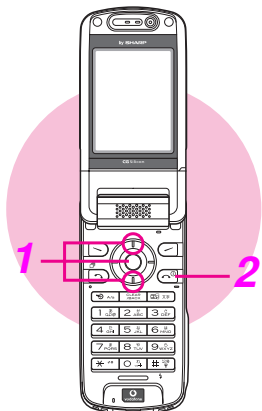

Main Menu ► *Call Log* ► *Call Timers*

1 Select *Received Calls* or *Dialed Calls* and press **⬇**

2 Press **⏪** to exit

Clear Timers Reset Call Timers

Main Menu ► *Call Log* ► *Call Timers*

Select *Clear Timers* ► Press **⬇** ► Enter Handset Code ► Press **⏪** **OK** ►
Press **⏪** **Yes**

Tip ►

- Last Call Time and All Calls Time remain even if handset power is turned off.
- Ring time for incoming or outgoing calls is not counted. On hold time is counted.

Call Charge

Check estimated call charge of the most recent call (Last Call Cost) and total charges (All Calls Costs).

Set a limit of total charges.

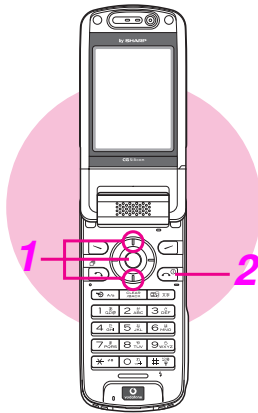

Main Menu ► Call Log ► Call Costs

1 Select **Last Call** or **All Calls** and press **⊙**

2 Press **⏪** to exit

Clear Costs Reset call charge records

Main Menu ► Call Log ► Call Costs

Select **Clear Costs** ► Press **⊙** ► Enter PIN2 ► Press **⊙** ► Press **⏪** **Yes**

Max Cost Set a limit of total charges
When the limit is exceeded, outgoing calls are blocked

Main Menu ► Call Log ► Call Costs

Select **Max Cost** ► Press **⊙** ► Select **Set Limit** ► Press **⊙** ► Enter PIN2 ► Press **⊙** ► Enter the amount ► Press **⊙**

To check the set limit, select **Max Cost** ► Press **⊙** ► Select **Read Limit** ► Press **⊙**

To check the remaining amount, select **Residual Credit** ► Press **⊙**

Cost Units Set conversion rate to calculate call charges

Default YEN 1

Main Menu ► Call Log ► Call Costs

Select **Cost Units** ► Press **⊙** ► Select **Set Units** ► Press **⊙** ► Enter PIN2 ► Press **⊙** ► Enter currency unit ► Press **⊙** ► Enter Cost per Unit ► Press **⊙** twice

To check Cost Unit, select **Cost Units** ► Press **⊙** ► Select **Read Units** ► Press **⊙**

Tip ►

- Last Call Cost and All Calls Costs remain even if handset power is turned off.
- Sum of charges appears for Conference Call (Optional Service).

Outside Japan (International Roaming)

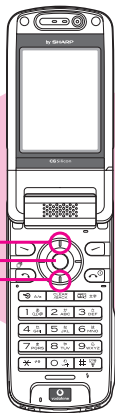

Changing System Settings

802SH is compatible with 3G and GSM network systems.

3G	Use in Japan or in 3G service area abroad
GSM	Use only in GSM service area outside Japan
Auto	Mode changes automatically depending on the current location (network status)

Auto is set by default.

Main Menu ▶ *Connectivity* ▶ *Network Settings*

1 Select **System Settings** and press ●

2 Select **3G or GSM** and press ●

- Selected system is activated.
- To change system automatically, select **Auto** ▶ Press ●

Note ▶

- For information on international roaming (available countries, areas, costs, functions or restrictions), contact Vodafone Customer Centre, General Information (see **P.16-32**).
- A separate subscription is required for international roaming.

Select Network Select a Network to connect

Default Automatic

Main Menu ▶ *Connectivity* ▶ *Network Settings* ▶ *Network Settings* ▶ *Select Network*

Select **Manual** ▶ Press ● ▶ Select a **Network** ▶ Press ●

- To change Network automatically, select **Automatic** ▶ Press ●
- To change priorities of Network selection for **Automatic**, see **P.9-14**.
- Adding Network: see **P.9-14**
- Use in default setting (**Automatic**). Set **Manual** to connect to a specific Network.

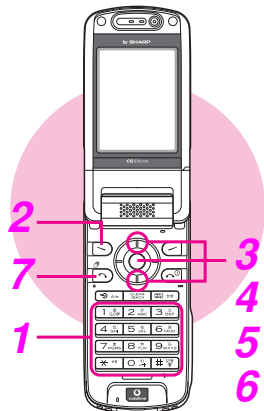

Calling from Outside Japan

1 Enter a phone number

- Include the dialling code for landline phone numbers.

■ When calling landlines or handsets within the country, proceed to Step 7.

■ To enter numbers directly, press for 1+ seconds (+ appears) ➔ Enter a country code ➔ Enter a phone number (omit the first 0) ➔ Proceed to Step 7

- When calling numbers in Italy (country code: 39) or Russia (country code: 7), include first 0.

2 Press Options

3 Select **Country Code** and press

4 Select a country and press

Country code appears.

Calling Unlisted Countries

- Select **Enter Code**, press and enter a country code.

Calling Vodafone Handsets

- Always select **日本 (JPN)** (country code: 81).

5 Press

6 Select **Abroad** and press

- + and country code are inserted before the phone number. The first 0 is omitted unless the country selected is Italy (39) or Russia (7). (+ indicates international calls.)

7 Press

Note ▶ Other party's voice may not be heard or handset microphone may be muted in some areas after placing a call on hold and cancelling it (see P.2-3).

Tip ▶ Adding Country Codes

To add country codes frequently used, see P.10-9 "Country Codes".

Manner Mode

Minding Mobile Manners

Please use your handset responsibly. Use these basic tips as a guide. Inappropriate handset use can be both dangerous and bothersome. Please take care not to disturb others when using your handset. Adjust handset use according to your surroundings.

- Turn it off in theatres, museums and other places where silence is the norm.
- Refrain from using it in restaurants, hotel lobbies, lifts, etc.
- Observe signs and instructions regarding handset use aboard trains, etc.
- Refrain from use that interrupts the flow of pedestrian or car traffic.

Manner-Related Features

■ Manner Mode (see P.2-17)

Press a single key to automatically mute all Ringtones and activate Vibration mode for incoming calls and mail.

■ Vibration Mode (see P.10-3)

Activate Vibration mode to use handset vibration to alert you to incoming calls, mail, etc. in public places.

■ Volume Settings (see P.10-2)

Decrease or mute Ringtone volume for incoming calls/mail as well as tones for Web or V-applications when carrying handset in public places.

■ Off Line Mode (see P.2-18)

Use Off Line Mode to suspend all handset transmissions. When Off Line Mode is active, incoming and outgoing calls/mail as well as Vodafone live! transmissions are blocked.





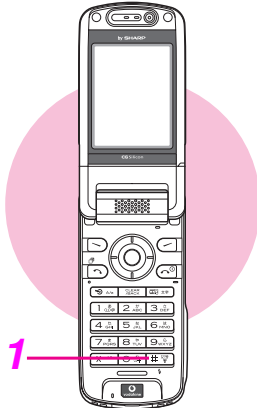

■ Message Recorder (see P.2-20)

Use Message Recorder to handle incoming calls when it is inappropriate or unsafe to answer.



Activating/Cancelling Manner Mode

Activate

- 1** Press **#**  for 1+ seconds
 and **Manner mode selected.** appear.
 (Message Recorder), ,
 (Silent) and  (Increasing Volume) appear
 as set in Manner settings.

Cancel







- 1** In Standby, press **#**  for 1+ seconds
 disappears and Manner mode is cancelled.

When Manner Mode is Active

- Keypad Tones, Power On/Off, error and barcode recognition tones are muted, but a beep for Switch Line still sounds (see **P.12-6**).
- Shutter click sounds even in Manner mode.
- **Manner mode active. Output sound?** appears when Media Player is activated.
- Message Recorder, Ringtone, Vibration and Mobile Light operate according to **Manner** settings.

- Tip** ▶
- When Message Recorder is recording messages, the other party's voice is heard through Earpiece.
 - To change Manner settings, see **P.10-2**.

To turn on/off Message Recorder in Manner mode, follow these steps.

Press  ➔ **Select Settings** ➔ Press  ➔ **Select Mode Settings** ➔ Press  ➔
Select Manner ➔ Press  **Options** ➔ **Select Personalise** ➔ Press  ➔ **Select**
Message Recorder ➔ Press  ➔ **Choose On or Off** ➔ Press 

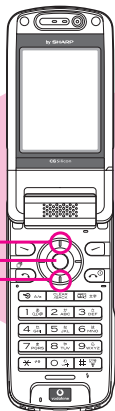

Activating/Canceling Off Line Mode

Use Off Line Mode to suspend all handset transmissions.

- In Off Line Mode, incoming and outgoing calls as well as Vodafone live! transmissions are blocked.
- Off Line Mode is **Off** by default.

Main Menu ▶ *Connectivity* ▶ *Network Settings* ▶ *Network Settings*

1 Select **Off Line Mode** and press **⊙**

2 Choose **On** or **Off** and press **⊙**

When **On** is set, **&** appears.

Tip ▶ When Off Line Mode is set while a Network V-application (see **P.15-2**) is paused, confirmation appears. Press **>** **Yes** to enter Off Line Mode. (Network connection is disabled until Off Line Mode is cancelled.)

Multi Stereo Headphones

Initiating Calls

Use Call Button on Multi Stereo Headphones to call the number saved in Speed Dial  (see **P.4-12**).

- 1 Plug Headphones into handset**
- 2 Press Call Button for 1+ seconds until a beep sounds**
 - The number is dialed.
- 3 Press Call Button for 1+ seconds until a beep sounds**
 - Call ends. Alternatively, press  to disconnect call.

Note ▶ If Speed Dial  is a Secret mode entry, activate Secret mode to call it (see **P.10-12**).

- Tip** ▶
- Cancel Phone Lock and Phone Book Lock to place calls (see **P.10-11**).
 - Do not wrap cord around handset or Internal Antenna. Electronic noise from cord may cause malfunction or interference.
 - Plug in Headphones firmly. If not, sounds may not be heard.

Answering Calls

- 1 Plug Headphones into handset**

Ringer sounds from Headphones and handset speaker.
- 2 Press Call Button for 1+ seconds**
 - Perform Step 3 on the left to end the call.

Message Recorder

Record caller messages on handset. Message Recorder cannot be used when handset is off, out-of-range or in Off Line Mode. Use Voice Mail to record caller messages when Message Recorder is not available (see P.12-4).

Record up to 90 seconds or 20 messages between Message Recorder and Voice Memo (see P.2-10).

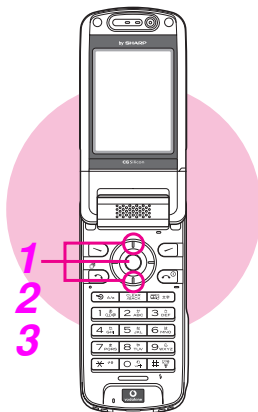

Activate/Deactivate

Main Menu ► Call Log ► Message Recorder

- 1 Select **Recorder Settings** and press ●
- 2 Select **On/Off Setting** and press ●
 - To sample outgoing message, select **Guidance Message** ► Press ●
 - To activate or mute Earpiece for outgoing message/caller message recordings, select **Volume** ► Press ● ► Select **Link to Profile** or **Silent** ► Press ●
- 3 Choose **On** and press ●
 - Press ◀ to return to Standby (☎ appears). (☎ appears in green when messages are recorded.)
 - To cancel, choose **Off** ► Press ●

Playing Messages

Main Menu ► Call Log ► Message Recorder





- 1 Select **Play** and press ●
 - Number of recordings appears and playback starts from the most recent message. After all messages have played, playback ends automatically.
 - Press ◀ **Back** to stop playback.
 - To skip a message, press ⏸ during playback.
 - To play the previous message, press ⏮ during playback.
 - To delete a message, press ⏻ **Options** during playback ► Select **Delete** ► Press ● ► Press ⏻ **Yes**

Tip ► Incoming Calls

Message playback stops for incoming calls. Press ◀ to answer the call.

Answer Time

- Adjust ring time between 0 and 59 seconds (Message Recorder waits to answer calls). Answer Time is **09 seconds** by default.

Press  **➔ Select Call Log** **➔ Press**  **➔ Select Message Recorder** **➔ Press**  **➔ Select Recorder Settings** **➔ Press**  **➔ Select Answer Time** **➔ Press**  **➔ Enter time (00 - 59)** **➔ Press**

- To start recording immediately after a call arrives, enter **00** **➔ Press** 

- When Message Recorder and Voice Mail or Call Forwarding are both active, response priority changes depending on ring time settings.

Example: Ring time for Message Recorder: 9 seconds
Ring time for Voice Mail or Call Forwarding: 10 seconds



In this example, Message Recorder responds first. (Priority may change depending on signal conditions.)

- If Message Recorder is full or handset is in Off Line Mode or out-of-range, incoming calls are handled by Voice Mail or Call Forwarding.

Message Recorder Disabled

When less than 12 seconds remain or 20 messages are recorded, Message Recorder is disabled. Delete messages (see **P.2-20**) to activate Message Recorder.

When Message Recorder is Active

- For incoming calls, outgoing message plays and recording starts.
 - Recording continues even if handset is closed.
 - To answer calls, press  during recording (no message will be recorded).
 - When recording ends,  appears.
- If recording capacity became full after the recording, Message Recorder is deactivated and  (black) appears.

Quick Recorder

Use Quick Recorder to record caller messages on handset when Message Recorder is inactive. When a call arrives, follow the steps below. Outgoing message plays and caller's message is recorded.

Press  **➔ Select Recording** **➔ Press** 

Text Entry

Characters

Use Kana and Pager (see **P.3-9**) to enter alphanumerics, Symbols, hiragana, kanji, katakana and Pictographs. Operations are described for Kana Mode except in "Pager Code" on **P.3-9**.

Entry Modes

Press **[Mode]** to toggle between character types as follows:

a → 1 → 絵 → 漢 → ア → ア → a → a ...

Alternatively, press **[Case]** to toggle between character types.



Available Modes

漢	Kanji (hiragana)
ア	Double-byte katakana
ア	Single-byte katakana
A	Double-byte alphanumerics (upper/lower case)
a	Double-byte alphanumerics (lower/upper case)
A	Single-byte alphanumerics (upper/lower case)
a	Single-byte alphanumerics (lower/upper case)
1	Single-byte number
絵	Pictograph Code
区	Character Code

Upper & Lower Case

In double- or single-byte alphanumerics mode, press **[Case]** to toggle between upper case and lower case. For Pager Mode (see **P.3-9**), in double- or single-byte character mode, press **[Case]** to toggle between upper and lower case.

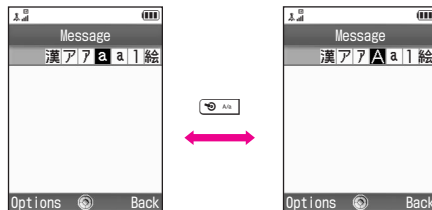

Double-byte Alphanumerics
(Lower Case)

Double-byte Alphanumerics
(Upper Case)

Pictograph & Character Codes

Press **[Code]** to toggle as follows:

Pictograph Code 1 → Pictograph Code 2 →

Pictograph Code 3 → Pictograph Code 4 →

Pictograph Code 5 → Pictograph Code 6 →

Character Code → Pictograph Code 1

- Current Pictograph Code page number appears at the bottom.

- Tip** ▶
- Handset Character Codes correspond to 6,355 kanji.
 - Some characters are not available for mail addresses, etc.













Key Assignments

Multiple characters are assigned to each key. Press a key to toggle between character options for that key.

Example: In katakana entry, press  three times for ウ.

When entering characters, press  to toggle between character options in reverse. (Not available for entering single-byte number, Pictographs and Character Codes.)

Example: Enter い, then press  to return to あ.

Key	Kanji (Hiragana) [Double-byte]	Katakana [Double & Single-byte]	Alphanumerics [Double & Single-byte]	Numbers [Single-byte]	Pictograph Code 1 - 6 & Character Codes
	あいうえお あいうえお	アイウエオ アイウエオ	@. /_—1 □ (space)	1	1
	かきくけこ	カキクケコ	A B C a b c 2	2	2
	さしすせそ	サシスセソ	D E F d e f 3	3	3
	たちつてとっ	タチツテトツ	G H I g h i 4	4	4
	なにぬねの	ナニヌネノ	J K L j k l 5	5	5
	はひふへほ	ハヒフヘホ	M N O m n o 6	6	6
	まみむめも	マミムメモ	P Q R S p q r s 7	7	7
	やゆよやゆよ	ヤユヨヤユヨ	T U V t u v 8	8	8
	らりるれる	ラリルレロ	W X Y Z w x y z 9	9	9
	わをんー、。 ‡ (Line Break)	ワワンー、。 ‡ (Line Break)	.. 0 ‡ (Line Break)	0 + ¹	0
	・ ・	・ ・ 2	Single-byte Mail/ Web Extensions ³	✕ P (Pause) ? - ⁴	_____
	Log, Double-byte Symbol ⁵ /Pictograph Code			#	_____
	Conversion (Up)	Cursor Up			

¹+ is for phone number entry. Press for 1+ seconds.

²- is available only in single-byte katakana entry.

³Extensions are listed for easy entry.

⁴P (Pause), ? and - are for phone number entry.

⁵Single-byte for single-byte katakana/alphanumeric entry.

Key	Kanji (Hiragana) [Double-byte]	Katakana [Double & Single-byte]	Alphanumerics [Double & Single-byte]	Numbers [Single-byte]	Pictograph Code 1 - 6 & Character Codes
	Conversion (Down)	Cursor Down ↓ (Line Break)			
	Cursor Left				
	Cursor Right				
	Change Character Type				
	Toggle case (for some characters)	Toggle case + Toggle mode (upper & lower/lower case)		_____	_____
 Press	Delete One Character/ Cancel Conversion	Delete One Character			Delete Code/ One Character
 Long Press	Delete before or after cursor				
	Recover up to 64 deleted characters ⁶				
	OK				
	Phonetic Conversion	_____			Switch Pictograph Code 1 - 6/Character Codes
	Hiragana to Katakana/ Alphanumerics Conversion	_____			Pictograph Code 1 - 6/ Log List

⁶Press once for each character to recover immediately after deleting. [Not available after deleting text with (Long Press).]

Entering Characters

Kanji, Hiragana & Katakana

Example: To enter **鈴木** in kanji (hiragana) entry mode

1 Press **3 DEF** three times

Word suggestions change as hiragana are entered.

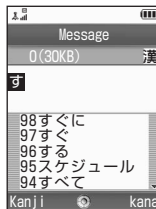

2 Press **OK**

- When the next character is on the same key, press **OK** first.

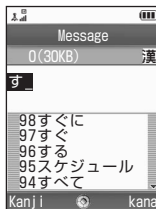

3 Press **3 DEF** three times and press *** ****



4 Press **2 ABC** twice

To enter hiragana without converting to kanji, skip to Step 6.

5 Press **OK** (convert) and use **OK** to select a word

- To see other suggestions, press **Back** or **Next**.
- To exit the list, press **Cancel**.
- To change segment, see **P.3-6**.

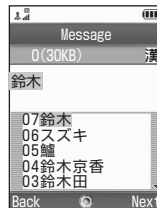
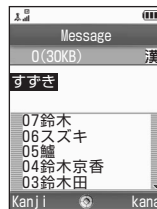

6 Press **OK**

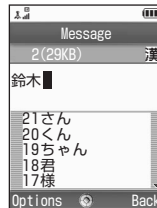

Tip ▶ Switch to double-byte or single-byte katakana mode to enter katakana. Alternatively, enter hiragana and then select katakana from the word suggestion list.

Learning Function

The most recently used word appears first in the list.

Predictive & Previous Usage

Use **Predictive** and **Previous Usage** to convert hiragana to kanji more quickly.



Predictive	Word suggestions change as up to 5 hiragana are entered
Previous Usage	Suggests words/characters likely to follow entry based on previous entries

- Both functions are active by default (see P.3-13).

User Dictionary

Save frequently used words/phrases to select from the word suggestion list (see P.10-8).

Segmenting Phrases

If the word is not in the list, press  after Step 5 on P.3-5 to exit. Then use  to segment hiragana to convert separately.

Example: Segment みち into み and ち.

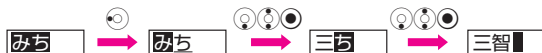

Selecting Multiple Converted Words

Press .

Example: To enter 西山大輔



Small Kana (っ, ッ, etc.)

Enter small hiragana あ, い, う, え, お, っ, や, ゆ and よ as well as small katakana.

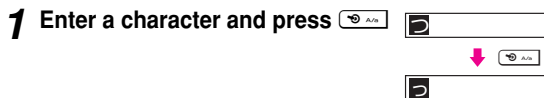

Deleting Log List

In a text entry window, press **Options** → **Select Input/Conversion** → Press → **Select Clear Symbols** → Press → Press **Yes**

- Press twice to return to the text entry window.
- Log List cannot be deleted in Pictograph Code mode.

Pictograph Code Mode

- To enter from Pictograph Codes, enter two digits (see **P.16-15**) in Pictograph Code mode.
 - To edit a code mid-entry, press to clear first digit then enter correct digits.
- To enter from Pictograph List, press **List** → Select a Pictograph → Press
 - To toggle through list 1 - 6 and Log List, press .

Emoticons

- 1 In a text entry window, press **Options**
- 2 Select **Emoticons** and press
- 3 Select an emoticon and press

- Alternatively, enter a descriptive word such as **わーい** or **うーん** and press (convert). Corresponding emoticons can be selected.
- Enter two digits (01 - 50) to jump to the emoticon assigned to the number.

- Tip** ▶
- Emoticons cannot be entered in Pictograph Code (1 - 6).
 - For other emoticons, enter **かお** and press (convert).

Space

- 1 In a text entry window, press

- Alternatively in alphanumeric entries, press seven times to enter a space.

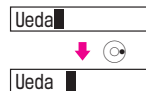

Line Break



Insert line breaks in mail message text, Text Templates, etc.

- 1 Press at the end of text

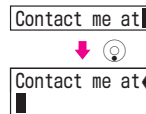
- To insert line breaks in text, press until appears, then press . Line break is inserted at the cursor position. Keystroke count varies by character entry mode (see **P.3-3**).



Mail & Web Extensions





- 1 In alphanumeric entry, press 
- 2 Select an extension and press 
 - Mail addresses and URLs are single-byte.





Character Code

- 1 In Character Code entry mode, enter four digits (see P.16-9)



Pager Code

- 1 In a text entry window, press  **Options**
- 2 Select *Input/Conversion* and press 
- 3 Select *Input Method* and press 
- 4 Select *Pager Code* and press 

Pager Code entry window opens.

 -  To switch to Kana Mode, select *Kana* → Press 
- 5 Enter two digits (see P.3-10)
 - Pager Mode is active until switched to Kana Mode.

Character Entry Modes



- For text entry in Pager Mode, press  to toggle between character modes as follows:
 - Single-byte lower case (P) → Pictograph Code 1 - 6 (絵/Character Code (区) → Double-byte lower case (P)
 - Press  to toggle between Pictograph Code 1 - 6 and Character Code mode.
- Press  to toggle between upper and lower case.

- Tip** ▶
- Hiragana to Katakana/Alphanumerics Conversion is disabled in Pager Mode.
 - To enter * or * , see Pager Code List on P.3-10.



■ Pager Code List

- Blanks indicate no entry.
- Upper and lower case are available for characters with grey background. Press  to switch.

Double-byte upper case

		Second digit (Press secondly)									
		1	2	3	4	5	6	7	8	9	0
First digit (Press first)	1	あ	い	う	え	お	A	B	C	D	E
	2	か	き	く	け	こ	F	G	H	I	J
	3	さ	し	す	せ	そ	K	L	M	N	O
	4	た	ち	つ	て	と	P	Q	R	S	T
	5	な	に	ぬ	ね	の	U	V	W	X	Y
	6	は	ひ	ふ	へ	ほ	Z	?	!	-	/
	7	ま	み	む	め	も	¥	&			*1
	8	や	(ゆ)	よ	✖	#	space		*2
	9	ら	り	る	れ	ろ	1	2	3	4	5
	0	わ	を	ん	*	°	6	7	8	9	0

Single-byte upper case



		Second digit (Press secondly)									
		1	2	3	4	5	6	7	8	9	0
First digit (Press first)	1	ア	イ	ウ	エ	オ	A	B	C	D	E
	2	カ	キ	ク	ケ	コ	F	G	H	I	J
	3	サ	シ	ス	セ	ソ	K	L	M	N	O
	4	タ	チ	ツ	テ	ト	P	Q	R	S	T
	5	ナ	ニ	ヌ	ネ	ノ	U	V	W	X	Y
	6	ハ	ヒ	フ	ヘ	ホ	Z	?	!	-	/
	7	マ	ミ	ム	メ	モ	¥	&			*1
	8	ヤ	(ユ)	ヨ	✖	#	space		*2
	9	ラ	リ	ル	レ	ロ	1	2	3	4	5
	0	ワ	ヲ	ン	.	'	6	7	8	9	0



Double-byte lower case



		Second digit (Press secondly)									
		1	2	3	4	5	6	7	8	9	0
First digit (Press first)	1	あ	い	う	え	お	a	b	c	d	e
	2						f	g	h	i	j
	3						k	l	m	n	o
	4			つ			p	q	r	s	t
	5						u	v	w	x	y
	6						z				
	7										*1
	8	や		ゆ		よ					*2
	9										
	0										

Single-byte lower case

		Second digit (Press secondly)									
		1	2	3	4	5	6	7	8	9	0
First digit (Press first)	1	ア	イ	ウ	エ	オ	a	b	c	d	e
	2						f	g	h	i	j
	3						k	l	m	n	o
	4			ツ			p	q	r	s	t
	5						u	v	w	x	y
	6						z				
	7										*1
	8	ヤ		ユ		ヨ					*2
	9										
	0										

¹Press   to insert line breaks (in mail message text, Text Templates, etc.).

²Press   to toggle between upper and lower case.

-  and  are double-byte.

Conversion Methods (Japanese Only)

Phonetic Conversion

Enter alternate readings to search for kanji.

- 1 Enter reading in hiragana
- 2 Press  **kanji** to see suggestions
- 3 Select a kanji and press  to enter



One-Hiragana Conversion

Enter the first hiragana to access previously selected words.

Example: To enter **鈴木**





- One-Hiragana Conversion and User Dictionary (see **P.10-8**) share memory. Selected words may not be saved if User Dictionary is full.
- Up to 20 word selections are saved per hiragana. When memory is full, the oldest entry is deleted to make room for a new entry, however, User Dictionary remains unchanged.

Hiragana to Katakana/Alphanumerics Conversion

Enter katakana and alphanumerics in kanji (hiragana) entry mode.

1 Enter hiragana and press kana

- To enter AM, press  , and then press  kana.

2 Use to select a word and press to enter

- Hiragana to Roman Letter Conversion (hiragana with * or ° is converted to the same characters/Symbols):

あ	@	い	.	う	/	え	_	お	Space
か	A	き	B	く	C	け	Space	こ	Space
さ	D	し	E	す	F	せ	Space	そ	Space
た	G	ち	H	つ	I	て	Space	と	Space
な	J	に	K	ぬ	L	ね	Space	の	Space
は	M	ひ	N	ふ	O	へ	Space	ほ	Space
ま	P	み	Q	む	R	め	S	も	Space
や	T	ゆ	U	よ	V	—	—	—	—
ら	W	り	X	る	Y	れ	Z	ろ	Space
わ	.	を	.	ん	Space	— (Long Sound)、。	Line Break	Space	Space



















- Hiragana to Number Conversion (hiragana with * or ° is converted to the same numbers):
 - あ (A) row...1 ■ か (Ka) row...2 ■ さ (Sa) row...3
 - た (Ta) row...4 ■ な (Na) row...5 ■ は (Ha) row...6
 - ま (Ma) row...7 ■ や (Ya) row...8 ■ ら (Ra) row...9
 - わをん— (Long Sound)、。 Line Break...0

Quick Conversion (for Hiragana)

Quick Conversion helps reduce keystrokes needed to enter frequently used words.

A list of word suggestions appears based on the key pressed.



Example: To enter 微妙

Normal Conversion	  * ** (び)   (み)
	      (よ)
	   (う)  (convert)
Quick Conversion (for Hiragana)	 * ** (ば)  (ま)  (や)  (あ)  (convert)

1 Enter hiragana and press

Cursor turns green.

- While cursor is green, use  to segment entered hiragana and then convert one segment at a time.

■ To cancel Quick Conversion, press  ➔ Press  for normal conversion

2 Use to select a word and press

Note ▶ Use Quick Conversion in kanji (hiragana) mode only.

Tip ▶ The most recently used word (mostly nouns) appears first.

One Hiragana Predictive Entry

Enter hiragana and initiate Quick Conversion. Words starting with a hiragana in the same row (あ, い, う, え, お for あ) appear. Word suggestions vary by time of day.

Example: When あ is entered

5:00 - 10:59	11:00 - 16:59	17:00 - 22:59	23:00 - 4:59
朝一番 朝帰り 行ってきます いってらっしゃい ⋮	あちい～ 後でね いただきま～す♪ 移動中 ⋮	遊ぼう 明日 急いで行くよ 今どこ? ⋮	アウチ!! ありがとう いえーい!!! 行こうね ⋮

- Words in the list are preset by time blocks.
- If Clock is not set, only words for 11:00 - 16:59 are available.

One Hiragana Word Call

Enter the first hiragana of entries you used Quick Conversion for. The most recently selected word appears first.

Example: You entered あたあさわ and selected お父さん last time.



Conversion Settings

Disable Predictive/ Previous Usage Disable *Predictive* or *Previous Usage* (see P.3-6)

Default On

In a text entry window, press **Options** ➔ **Select Input/ Conversion** ➔ Press ➔ **Select Predictive or Previous Usage** ➔ Press ➔ **Choose Off** ➔ Press

Clear Conversion Log Delete words selected in kanji conversion, Predictive, etc.

In a text entry window, press **Options** ➔ **Select Input/Conversion** ➔ Press ➔ **Select Reset Learning** ➔ Press ➔ Press **Yes**

- Words saved in User Dictionary remain.

Editing Characters

Deleting

1 Use  to select a character and press .

Kinoshita





- The highlighted character is deleted.
- Place cursor at the end of text and press  for 1+ seconds to delete all text.

Kinoshita

When cursor is located amidst a block of text, characters on and after cursor are deleted.

Replacing

1 Press  to delete a character

Mikako

2 Enter another character





Mikko





Mikiiko

Copy/Cut & Paste

When **Options** appears, copy or cut and paste text into the same window or another.

1 In a text entry window, press  **Options**

2 Select **Copy** or **Cut** (to move) and press .

3 Move cursor to the first character of text and press .

Start point is set. (**End** appears.)

 To change the start point, press .

4 Move cursor to the end of text and press .

5 Open text paste target window

6 Press  **Options**, select **Paste** and press .

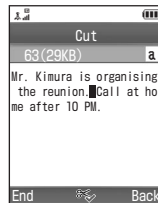

Example

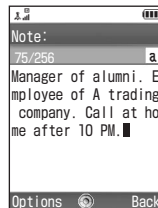

Deleting Text After Cursor

- 1 Move cursor to target location
- 2 Press **Options**
- 3 Select *Delete Posterior* and press **Enter**

Using Phone Book

Insert Phone Book entry items into text entry windows. Select from phone numbers, mail addresses, postal addresses or Note.

- 1 In a text entry window, press **Options**
Move cursor to target location beforehand.
- 2 Select *Advanced* and press **Enter**
- 3 Select *Phone Book* and press **Enter**
- 4 Open a Phone Book entry
 - Open *My Details* to insert Owner Profile contents.
- 5 Use **Enter** to select an item and press **Enter**
Item is inserted following the Phone Book entry name.

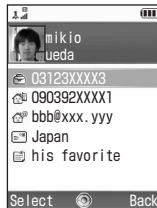

Using Text Templates

- 1 In a text entry window, press **Options**
- 2 Select *Text Templates* and press **Enter**
- 3 Select *Call Text Memo* and press **Enter**
- 4 Select a file and press **Enter**
Text is inserted.

Saving from Message or Phone Book

Save text to Text Templates.

In a text entry window, press **Options** → *Select Text Templates* → Press **Enter** → *Select Save Text Memo* → Press **Enter** → Move cursor to the first character of text → Press **Enter** → Move cursor to the end of text → Press **Enter**

- Save up to 256 characters.

Phone Book

Saving to Phone Book

Phone Book Entry Items

Save up to 500 entries to handset Phone Book. On USIM Card, the number of entries you can save in Phone Book depends on the card specification. Depending on the USIM Card in use, mail addresses may not be supported or character entry limits for mail address may be lower. Also, the number of phone numbers or mail addresses per entry and entry character limits may be lower.

Item	Description	Save to	
		Handset	USIM Card
Last Name:	Enter up to 16 characters. (Select Name: when saving to USIM Card.)	Available	Available
First Name:			
Reading:	Enter up to 32 characters	Available	Available
Add Telephone:	Enter up to three numbers to handset and two numbers to USIM Card (32 digits each)	Available	Available
Add Email Address:	Enter up to three addresses to handset (128 single-byte characters each), and one address to USIM Card (80 single-byte characters)	Available	Available
Group:	Sort entries into 16 Groups (handset) and 11 Groups (USIM Card). Group names can be changed. Set Ringtone by Group (handset only).	Available	Available
Postcode:	Enter up to 20 characters	Available	N/A
Country Name:	Enter up to 32 characters	Available	N/A
State Name:	Enter up to 64 characters	Available	N/A
City Name:	Enter up to 64 characters	Available	N/A
Street Name:	Enter up to 64 characters	Available	N/A
Note:	Add personal details. Enter up to 256 characters.	Available	N/A
Birthday:	Enter birth date	Available	N/A
Picture:	Set an image to appear for incoming calls/mail	Available	N/A
Assign Tone/Video:	Set Ringtone or Ringvideo by caller	Available	N/A
Secret:	Restrict access to Phone Book entries by saving them as Secret	Available	N/A

Note ▶ **Back-up Important Information**
Keep a separate copy of important information. When battery is exhausted or removed for long periods, Phone Book entries may be lost. Handset damage may also affect information recovery. Vodafone is not liable for any damages resulting from accidental loss/alteration.

Tip ▶ Use Phone Book Lock to protect entries from accidental alteration and to restrict access to Phone Book information (see P.10-11).

New Phone Book Entries

Enter a name, reading, phone number and mail address.

- Select storage media (handset or USIM Card) for new entries.
- Storage media is **Handset** by default.

Storage Media

Set default storage media for new entries.

Press ● ▶ **Select Phone Book** ▶ **Press** ● ▶
Select Advanced ▶ **Press** ● ▶ **Select Save New Entry** ▶ **Press** ● ▶ **Select Handset, SIM or Choice** ▶ **Press** ●

- For **Choice**, select Storage media for each new entry.

Name

Main Menu ▶ Phone Book ▶ Phone Book List

1 Select **Add New Entry** and press ●

Phone Book Details opens.

2 Select **Last Name:** and press ●

3 Enter last name and press ●

4 Select **First Name:** and press ●

5 Enter first name and press ●

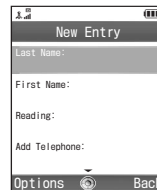

Phone Book Details

Phone Number

Main Menu ▶ Phone Book ▶ Phone Book List ▶ Add New Entry

1 Select **Add Telephone:** and press ●

2 Enter a phone number

- Include the dialling code for landline phone numbers.

3 Press ●

4 Select an icon and press ●

- To save additional phone numbers, select **Add Telephone:** ▶ Press ● ▶ Repeat Steps 2 - 4

Mail Address

Main Menu ▶ Phone Book ▶ Phone Book List ▶ Add New Entry

- 1 Select **Add Email Address:** and press **⓪**
- 2 Enter a mail address
- 3 Press **⓪**
- 4 Select an icon and press **⓪**

■ To save additional mail addresses, select **Add Email Address:**
 ➔ Press **⓪** ➔ Repeat Steps 2 - 4

Call Arrives while Creating Entry

Contents are temporarily saved for later entry.

Saving

- 1 Press **⏪** **Save**

Warning Message

On Display	Cause	Operation
Mandatory field is empty.	Required item is not entered	Enter first/last name, phone number, or mail address and retry

Tip ▶ Via Bluetooth or infrared, exchange Phone Book entries with other Vodafone handsets, PCs and other devices (see P.9-2).

Additional Settings

Personal Ringtone/Ringvideo

Select incoming Ringtones or Ringvideos for numbers or mail addresses saved in Phone Book.

Select from preset patterns or use the following sound or video files in Data Folder.

- Files in Sounds & Ringtones folder (file name: 51 characters or less)
- Files in Videos folder (file name: 51 characters or less)

Main Menu ▶ Phone Book ▶ Phone Book List ▶ Add New Entry

- 1 Select **Assign Tone/Video:** and press **⓪**
- 2 **For Voice Calls**

- 1 Select **For Voice Call** and press **⓪**

For TV Calls

- 1 Select **For TV Call** and press **⓪**

For Mail Messages

- 1 Select **For New Message** and press **⓪**

- 3 **Ringtone**

- 1 Select **Assign Tone** and press **⓪**

■ To cancel, select **Remove Tone/Video** ➔ Press **⓪** ➔ Press **⏪** **Yes**

- 2 Select **Preset Sounds or My Sounds** and press **⓪**

Ringvideo

- 1 Select **Assign Video** and press **⓪**

■ To cancel, select **Remove Tone/Video** ➔ Press **⓪** ➔ Press **⏪** **Yes**

4 Select sound or video and press

Preset Ringtones play when selected. Press  **Assign** to set.

- Files on SD Memory Card cannot be selected.

- Note** ▶
- When source file in Data Folder is deleted, renamed or moved to SD Memory Card, **Ibiza Party** is set for Voice/TV Calls, and **Sound Effect 1** is set for mail messages.
 - This also applies if source file is copyrighted and the license expires.
 - To apply the setting to Secret mode entries, activate Secret mode first.

Personal Picture

Set saved photos to appear for incoming calls/mail.

Select from image files smaller than 40 KB.

Main Menu ▶ Phone Book ▶ Phone Book List ▶ Add New Entry

1 Select **Picture:** and press

2 Select **Assign Picture** and press

- To cancel, select **Remove Picture** ▶ Press  ▶ Press  **Yes**

3 Select an image and press





















- Files on SD Memory Card and some other files cannot be selected.

- Note** ▶ Setting is cancelled when source file in Data Folder is deleted, renamed or moved to SD Memory Card.





Other Phone Book Entry Items

To enter the following, open Phone Book Details (see P.4-3).

For details, refer to "Phone Book Entry Items" on P.4-2.

Reading	Select Reading: ▶ Press  ▶ Enter reading ▶ Press 
Group	Select Group: ▶ Press  ▶ Select group ▶ Press 
Postcode	Select Postcode: ▶ Press  ▶ Enter postcode ▶ Press 
Country Name	Select Country Name: ▶ Press  ▶ Enter name ▶ Press 
State Name	Select State Name: ▶ Press  ▶ Enter name ▶ Press 
City Name	Select City Name: ▶ Press  ▶ Enter name ▶ Press 
Street Name	Select Street Name: ▶ Press  ▶ Enter name ▶ Press 
Note	Select Note: ▶ Press  ▶ Enter text ▶ Press 
Birthday	Select Birthday: ▶ Press  ▶ Enter date ▶ Press 
Secret	Select Secret: ▶ Press  ▶ Choose On or Off ▶ Press 

Saving from Dialed Numbers/Received Calls

- 1 Press  to open Dialed Numbers or Received Calls
- 2 Select a phone number with  and press  **Options**
- 3 Select **Save Number** and press 
- 4 **New Entry**
 - 1 **Select As New Entry** and press 

Phone number is entered automatically. Complete other fields and save the Phone Book entry.

Add to Existing Entry

- 1 **Select a Phone Book entry** and press 

Phone number is entered automatically. Complete other fields and save the Phone Book entry.

Note ► Received calls without Caller ID cannot be saved to Phone Book.

Phone Book Memory Status

Main Menu ► Phone Book ► Advanced

- 1 Select **Memory Status** and press 

Numbers of entries on handset and USIM Card appear.

Press  to exit.

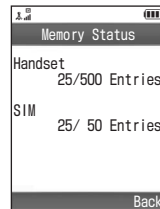

Group Settings

Rename Groups and customise Ringtone settings by Group.

Changing Group Name

Main Menu ▶ Phone Book ▶ Manage Group

- 1 Select a Group and press ●
- 2 Enter a name
 - Enter up to 16 characters.
- 3 Press ●
- 4 Press ▸ **Yes**
 - Repeat Steps 1 - 4 for other Groups.

Group Ringtone/Ringvideo

- Set Ringtone or Ringvideo (incoming calls/mail) by Group.
- Personal Ringtone/Ringvideo settings (see **P.4-4 - 4-5**) take priority over.
 - Group Ringtone/Ringvideo setting is not available for Phone Book entries on USIM Card.

Main Menu ▶ Phone Book ▶ Manage Group

- 1 Select a Group and press ▸ **Options**
- 2 Select **Assign Ringtone** and press ●
- 3 Select **For Voice Call, For TV Call or For New Message** and press ●
- 4 **Ringtone**
 - 1 Select **Assign Tone** and press ●
 - ▭ To cancel, select **Remove Tone/Video** ▶ Press ● ▶ Press ▸ **Yes**
 - 2 Select **Preset Sounds or My Sounds** and press ●
- 5 **Ringvideo**
 - 1 Select **Assign Video** and press ●
 - ▭ To cancel, select **Remove Tone/Video** ▶ Press ● ▶ Press ▸ **Yes**
- 5 **Ring Time for Mail**
 - 1 Select **Duration** and press ●
 - 2 Enter time (01 - 15 seconds) and press ●
- 5 Select sound or video and press ●

Preset Ringtones play when selected. Press ▸ **Assign** to set.

 - Files on SD Memory Card cannot be selected.

Selecting Phone Book Location

Customise Group settings for handset or USIM Card Phone Book entries separately. To select a Phone Book, follow these steps.

Press **⊙** ➔ **Select Phone Book** ➔ Press **⊙** ➔
Select Advanced ➔ Press **⊙** ➔ **Select Ph.Book Location** ➔ Press **⊙** ➔ **Select Handset or SIM** ➔
 Press **⊙**

Using Phone Book

Dialling from Phone Book

Display



1 Name

2 Image set for Picture

3 Phone Number

4 Mail Address

5 Group Name

6 Postal Address

Postcode, country name, state name, city name and street name are separated by commas and line breaks.

7 Note

8 Birthday

9 Tone/video set for incoming calls/mail

10 Secret On

Tip ▶ To dial numbers saved in Secret mode entries, activate Secret mode first (see **P.10-12**).

Phone Book Search

Search method is **By Reading Order** by default.

By Reading Order	Shows entries that start with specified Reading
By Group	Opens entries in the specified Group
By Katakana	Shows entries with Readings that start with katakana in the specified row

Main Menu ▶ Phone Book ▶ Advanced ▶ View Phone Book

1 Select **By Reading Order**, **By Group** or **By Katakana** and press ●

Phone Book Search on USIM Card

Open Phone Book on USIM Card as follows:

Press ● ▶ Select **Phone Book** ▶ Press ● ▶
Select **Advanced** ▶ Press ● ▶ Select **Ph.Book Location** ▶ Press ● ▶ Select **SIM** ▶ Press ●

- Start entry search.

Dialling from Phone Book Search

By Reading Order Search by reading to dial

■ Set search method to **By Reading Order** (see left).

Press ● ▶ Enter reading ▶ Select a name ▶ Press ●
▶ Press ↶

■ Entry Modes: see P.3-2

By Group Search by Group to dial

■ Set search method to **By Group** (see left).

Press ● ▶ Select a Group ▶ Press ● ▶ Select a name ▶ Press ● ▶ Press ↶

By Katakana Search by katakana row including the first character of Reading to dial

■ Set search method to **By Katakana** (see left).

Press ● ▶ Specify a row ▶ Select a name ▶ Press ●
▶ Press ↶

■ Press ● to switch katakana rows.

Speed Dial

Use Speed Dial List (see **P.4-12**) to call phone numbers quickly.

1 Press a key (**2** - **9**) for 1+ seconds

Name and phone number appear and the number is dialed.



- Alternatively, select a name from Speed Dial List (see **P.4-12**) and press .

Note ▶ To dial numbers saved in Secret mode entries, activate Secret mode first (see **P.10-12**).





Editing Phone Book

Correction/Change

Main Menu ▶ Phone Book ▶ Phone Book List

- 1 Open a Phone Book entry and press  **Options**
- 2 Select *Edit/Add Details* and press 
- 3 Select an item and press 

Edit contents.

 - Procedure is the same as when saving to Phone Book.
- 4 Press  when finished
 - ▶ To edit other items, repeat Steps 3 - 4.
 - ▶ To cancel, press  ▶ Press  **Yes**
- 5 Press  **Save**

The entry is overwritten.

Copying Phone Book Entries

Exchange entries between handset and USIM Card. Some Phone Book entry items cannot be saved to USIM Card (see **P.4-2**). Those items are deleted when Phone Book entries are copied from handset.

One Entry

Copy Phone Book entries one by one.

Main Menu ▶ Phone Book ▶ Phone Book List ▶ *Select a name*
▶ Options (⏏) ▶ Advanced

1 Handset to USIM Card

1 Select **Copy to SIM** and press ●

Some Phone Book entry items cannot be copied to USIM Card. (**Some data may be lost. OK?** appears.)

2 Press ⏏ **Yes**

USIM Card to Handset

1 Select **Copy to Handset** and press ●

All Entries

Copy all Phone Book entries at once. If handset or USIM Card memory is low, entries cannot be copied all at once.

Main Menu ▶ Phone Book ▶ Advanced ▶ Copy All Entries

1 Select **SIM to Handset** or **Handset to SIM** and press ●

2 USIM Card to Handset

1 Press ⏏ **Yes** twice

Handset to USIM Card

1 Press ⏏ **Yes** three times

Deleting Phone Book Entries

One Entry

Main Menu ▶ Phone Book ▶ Phone Book List

1 Open a Phone Book entry and press ⏏ **Options**

2 Select **Delete** and press ●

3 Press ⏏ **Yes**

Note ▶ The source files remain in Data Folder, even if you delete entries containing sound files or images set for incoming calls/mail or Picture.

All Entries

Delete all Phone Book entries on handset or USIM Card.

Main Menu ▶ Phone Book ▶ Advanced ▶ Del. All Entries

1 Select **Handset Entries** or **SIM Entries** and press ●

2 Press ⏏ **Yes** twice

3 Enter Handset Code

4 Press ●

Speed Dial List

Saving Phone Numbers

Save phone numbers to Speed Dial List for easy dialling (see P.4-10).

Main Menu ▶ Phone Book

- 1 Select **Speed Dial List** and press **⊙**
Speed Dial List opens.
- 2 Select a key (**2** - **9**) and press **⊙**
- 3 Select a Phone Book entry
- 4 Press **⊙**
 - When multiple numbers are saved, select one and press **⊙**.

Saving from Phone Book

Open a Phone Book entry, select a phone number and press **⊻** **Options** ▶ Select **Add Speed Dial** ▶ Press **⊙** ▶ Select from **2** to **9** ▶ Press **⊙**

Tip ▶ Use Call Button on Multi Stereo Headphones to call the number saved in **2** (see P.2-19).

Deleting Phone Numbers

One by One

Main Menu ▶ Phone Book ▶ Speed Dial List

- 1 Select a number and press **⊻** **Options**
- 2 Select **Delete** and press **⊙**
- 3 Press **⊻** **Yes**

All at Once

Return Speed Dial List to the default state.

Main Menu ▶ Phone Book ▶ Speed Dial List ▶ **Options** (**⊻**) ▶ Clear All

- 1 Press **⊻** **Yes**

Owner Profile

Confirm handset number (phone number on USIM Card).
Save name, reading, phone number, mail address, personal data, etc.

Main Menu ▶ Phone Book

1 Select *My Details* and press ●

2 Press ⏪ to exit

- Owner Profile contents are similar to those of Phone Book (see P.4-8).
- Via Bluetooth or infrared, exchange Owner Profile with compatible devices (see P.9-2).

Edit

Edit Owner Profile

Main Menu ▶ Phone Book ▶ My Details ▶ Options (⏪)

Select *Edit/Add Details* ▶ Press ● ▶ Select an item
▶ Press ●

- For more, see P.4-3 - 4-5.

Delete

Delete Owner Profile

Main Menu ▶ Phone Book ▶ My Details ▶ Options (⏪)

Select *Delete* ▶ Press ● ▶ Press ⏩ Yes

Note ▶ *Tel 1*: cannot be changed or deleted.

TV Call

Getting Started

Communicate with another party with live video images.

- Send your image via Internal Camera.
- For a higher quality image, use External Camera.



Internal Camera

Window Description

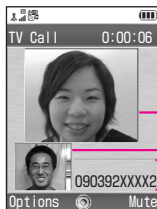

Other Party's Image¹

Your Image¹

Other Party's Name/Number²

¹Switch image positions.

²Name appears if saved in Phone Book.

Important TV Call Usage Notes

- TV Call is available only between compatible handsets.
- TV Call may be interrupted if the other party is using a different TV Call system. (Charges apply until the call ends.)
- Depending on the other party's handset specifications or settings, received image may appear small or not at all.
- If subjects are moving, received image may appear frame by frame or block noise may occur.
- Conversations may be hampered by ambient noise. Use Multi Stereo Headphones in this case.
- Conversations through Loudspeaker (see **P.5-5**) may be difficult when Earpiece Volume is set too high. Keep the volume moderate or use Multi Stereo Headphones.
- Handset heats up during TV Calls or while charging battery. This is normal.

Initiating a TV Call

1 Turn handset power on and enter a phone number

- Enter a number directly or from Phone Book, Dialed Numbers or Received Calls.

2 Press **Options**

3 Select **TV Call** and press

When the call is answered, the other party's image appears.

- For basic operations (adjusting Earpiece Volume, placing calls on hold, etc.), refer to procedures for Voice Call.



■ Operations during a TV Call: see **P.5-4**

4 Press to end call

- Alternatively, close handset.



Viewer Position Place TV Calls with Display in Viewer position

Press  **➔ Select Phone Book** **➔ Press**  **➔ Open an entry (see P.4-9)** **➔ Press**  **➔ Select TV Call** **➔ Press** 

■ Press  to end call.

Answering a TV Call

1 When a TV Call arrives, open handset

TV Call... appears.

- Answer, forward or reject the call (see **P.2-5 - 2-6**).



2 Answer with Video Image

1 Press

Image is sent via Internal Camera.

■ Operations during a TV Call: see **P.5-4**

Answer with Voice Only

1 Press **Voice**

■ Operations during a TV Call: see **P.5-4**





3 Press to end call

- Alternatively, close handset.

Viewer Position Answer TV Calls with Display in Viewer position

Answer with Video Image

When a TV Call arrives, press 

■ Press  to end call.

Answer with Voice Only

When a TV Call arrives, press  (Long Press)

■ Press  to end call.

Engaged TV Call Operations

Switch Cameras Toggle between Internal Camera and External Camera

Default Internal Camera

During a call, press  to toggle between Internal Camera and External Camera



Note ▶ When External Camera is used and handset becomes too hot, **Temperature is high. Switch cameras.** appears. If camera is not switched to Internal Camera, **Handset is hot. Switch to Alternative Image.** appears and alternative image appears. When you attempt to switch to External Camera while handset is too hot, **Handset is hot. Cannot switch to external camera.** appears and Internal Camera or alternative image returns.

Swap Images Switch locations of each other's images

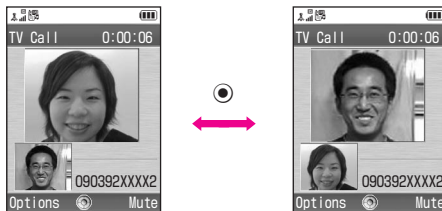
Press  during a call



Send Alternative Image Send a saved image instead of live video image



During a call, press  **Options** ➔ **Select Camera Picture**
➔ **Press  ➔ Select Alt. Image ➔ Press **

- To set an alternative image, see P.5-5.





Mute

Mute your voice and replace your image with a preset image

During a call, press  **Mute**

 To cancel, press  **Unmute**.

Additional Engaged TV Call Operations

- **Mobile Light:** Press  for 1+ seconds to illuminate. (Available only for External Camera.)
- **Digital Zoom:** Press  (zoom in) or  (zoom out)
 - External Camera: Up to 9-level Zoom
 - Internal Camera: Up to 2-level Zoom
- Press  **Options** to access the following:

	Loudspeaker On/Off	Activate or deactivate Loudspeaker
Settings	Picture Quality	Select quality of incoming images
	Backlight	Set Backlight status
	Exposure	Select brightness of outgoing images from five levels (-2 to +2)
	Bluetooth Headset	Activate or deactivate Bluetooth Headset
	Hold/Retrieve	Hold or resume TV Calls
	Open Phone Book	Open a Phone Book entry

TV Call Settings

Default Image

Send live video image or alternative image when initiating TV Calls

Default Internal Camera

Main Menu

▶ Settings ▶ TV Call Settings ▶ Camera Picture ▶
Default Image

Select **Internal Camera or Alternative Image** ▶ Press ●

- **Ext. Camera** (External Camera) can only be selected during a call.

Setting Alternative Image

Select an image to send as an alternative image

Main Menu

▶ Settings ▶ TV Call Settings ▶ Camera Picture ▶
Alternative Image

Select Substitute Image

Press ● ▶ Select **Preset Picture or My Pictures** ▶

Press ● ▶ Select an image ▶ Press ●

Loudspeaker

Activate Loudspeaker when initiating TV Calls

Default Loudspeaker On

Main Menu

▶ Settings ▶ TV Call Settings

Select **Loudspeaker On or Loudspeaker Off** ▶

Press ●

- Setting is also available during a call.

Picture Quality

Select quality of incoming images

Default Normal

Main Menu

▶ Settings ▶ TV Call Settings ▶ Picture Quality

Select **Normal, Quality Prior** (prioritise quality) or
Frame Rate Prior (prioritise frame rate) ▶ Press ●

- Setting is also available during a call.

Backlight

Select Backlight status for TV Calls

Default On

Main Menu

▶ Settings ▶ TV Call Settings ▶ Backlight

Select **On, Normal Setting or Off** ▶ Press ●

- For **Normal Setting**, Backlight illuminates as set in Display Settings (see **P.10-6**).
- Setting is also available during a call.

Mute Microphone

Mute your voice when initiating TV Calls

Default Unmute Microphone

Main Menu

▶ Settings ▶ TV Call Settings

Select **Mute Microphone or Unmute Microphone** ▶
Press ●

- Setting is also available during a call.

Hold Guidance Pict

Select an image to send while placing calls on hold

Main Menu

▶ Settings ▶ TV Call Settings ▶ Hold Guidance
Pict

Select **Preset Pictures or My Pictures** ▶ Press ● ▶
Select an image ▶ Press ●

Camera

Getting Started

802SH features a 1.3 megapixel CCD camera. Capture still images and record video.

- Still Images: see **P.6-5**
- Video: see **P.6-10**
- Key Assignments: see **P.6-4**
- Shooting Options: see **P.6-13**

Some key operations are indicated for Viewer position and clamshell open.

Example: Press  or .

■ File Formats & Save Locations

Mode	File Format	Save Location
Photo Camera	JPEG (.jpg)	Handset Data Folder (Pictures) or SD Memory Card Data Folder (Pictures/DCIM) See P.8-2 .
Video Camera	MPEG-4 (.3gp)	Handset or SD Memory Card Data Folder (Videos) See P.8-2 .
	MPEG-4 (.ASF)	SD Memory Card Data Folder (SD VIDEO)

Precaution

Use a soft cloth to wipe fingerprints and oil off lens cover (see **P.1-10**).

Mobile Camera Basics

- If handset moves while shooting, images may blur. Hold handset firmly or place it on a stable surface and use Timer (see **P.6-14**).
- Mobile camera is a precision instrument; however, some pixels may appear brighter or darker.
- Shooting/saving images while handset is hot may affect image quality.
- Subjecting the lens to direct sunlight will damage the camera's colour filter.

Auto Shut-off

- Mobile camera automatically ends if handset becomes too hot. To reactivate, wait until handset cools down.
- Before image capture, mobile camera ends after five minutes of inactivity and Standby returns.

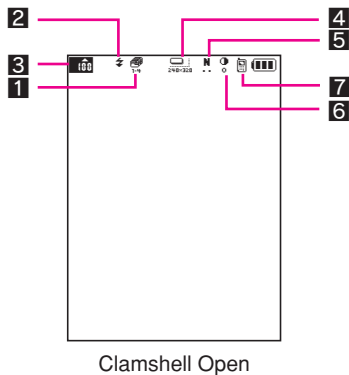
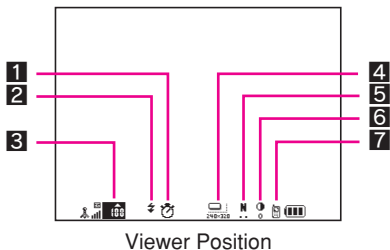

1 Timer (see P.6-14) & Continuous Shoot (see P.6-8)

- Picture Count

📷 - 📷: Captured/Total

- Continuous Shoot

📷: 4 Pictures, 📷: 9 Pictures

📷: Bracket, 📷: Overlapped

2 Mobile Light (see P.6-14)

⚡: On, ☀️: Auto, 🌙: Low Light

3 Capacity (see P.6-5)

Number of images savable

- 📷: More than 100

- Red background: 3 or less

4 Picture Size (see P.6-15)

5 Picture Quality (see P.6-16)

N: Normal, F: Fine, H: High Quality

6 Exposure (see P.6-15)

⬇️ -2 ⬇️ -1 0 ⬆️ +1 ⬆️ +2

Dark ➔ Standard ➔ Bright

7 Save Location (see P.6-17)

📱: Handset, 📁: SD Memory Card, 📁: Choice

Viewfinder & Key Assignments

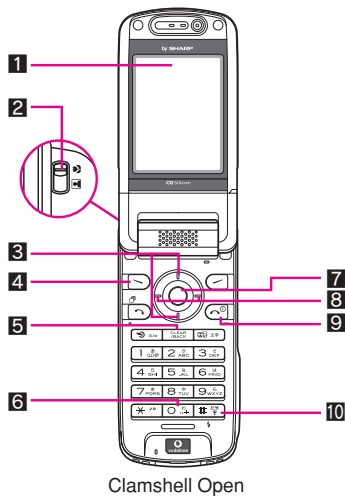

Clamshell Open

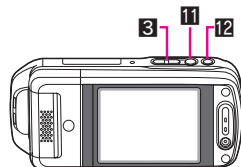

Viewer Position

1 Viewfinder

In Viewer position, images appear with a longer horizontal and shorter vertical.

2 Portrait/Macro Selector

Slide to Macro to capture images as close as 10 cm. Allow at least 40 cm for Portrait.

3 Zoom

▶ or ⏪: Zoom in, ◀ or ⏩: Zoom out

4 Options

5 Cancel

Press to start over.

6 Toggle Preview & Picture Size (see P.6-13)

Press to toggle as follows:

- Toggle Preview (for Photo Camera mode):
Full Viewfinder ⇔ **Normal Finder**
- Picture Size (for Video Camera mode):
Large(QCIF) ⇔ **Small(SubQCIF)**

7 Shutter

8 Toggle Mode

⊙: Photo Camera mode, ⊕: Video Camera mode

9 End

10 Mobile Light (see P.6-14)

The mode toggles as follows: **On** (☺) → **Auto** (⊕) → **Low Light** (☹) → **Off**.

Press [5] to change the light colour.

11 Camera Startup & Shutter

In Standby, press for 1+ seconds to activate the mode used last. Press to capture images, open selected menu items or execute functions.

12 Options & End

Press for 1+ seconds to return to Standby.

- Tip** ▶
- In Viewer position, open Options menu to use functions. See the corresponding pages for details.
 - Accessible functions vary by mode. Refer to "Still Image Functions" on **P.6-7** and "Video Recording Operations" on **P.6-12**.
 - View a summary of key assignments while using camera (see **P.6-17**).

Still Images

Photo Camera Mode

Capture images to send via MMS, save as Wallpaper, etc. Various settings and functions are available for camera use.

Picture Size	W 960 x H 1280 dots (Quad-VGA) W 768 x H 1024 dots (XGA) W 480 x H 640 dots (VGA) W 240 x H 320 dots (QVGA) W 120 x H 160 dots (QQVGA) W 120 x H 128 dots
Save Location	Handset Data Folder (Pictures) or SD Memory Card Data Folder (Pictures/DCIM ¹)
Picture Quality	Normal/Fine/High Quality
Digital Zoom	W 960 x H 1280 dots: None W 768 x H 1024 dots: 1x - 1.25x W 480 x H 640 dots: 1x - 2x W 240 x H 320 dots: 1x - 8x W 120 x H 160 dots: 1x - 16x W 120 x H 128 dots: 1x - 16x
Attach to MMS	OK
Format	JPEG (.jpg) ²
Memory Capacity	Approximately 1,000 files ³

¹Available for W 480 x H 640 dots (VGA) or larger images.

²Default file name is also the captured date and time. (Example: **2004-12-15_12-34.jpg** indicates the image was captured at 12:34, 15 December 2004.)

³Approximate value for handset Data Folder, with default image size and quality.

- Tip** ▶
- Saving video, sounds or V-applications reduces memory for still images.
 - To check memory status, see **P.10-13**.

Capturing Still Images

View a summary of key assignments while using camera (see **P.6-17**).

Viewer Position

Main Menu ▶ Camera

1 Frame image on Display

- When in Video Camera mode, press **Options** ▶ Select **to Photo Camera** ▶ Press **Options**
- Key Assignments: see **P.6-4**
- Shooting Options: see **P.6-13**



2 Press **Options**

- Shutter clicks and the captured image appears.
- Shutter click sounds even in Manner mode.
 - To start over, press **Options**.



3 Press **Options** to save image

Saving appears and the image is saved. Viewfinder returns for another shot.

- When **Save Pictures to** is set to **Choice**, select a save location and press **Options**.

4 Press **Options** for 1+ seconds to exit

- Tip** ▶
- Change shutter click sound (see **P.6-13**). Volume is fixed.
 - Set handset to save captured images automatically (see **P.6-18** "Auto Save").

Clamshell Open & Self Portrait

Main Menu ▶ Camera

1 Frame image on Display



- When in Video Camera mode, press **Options** ▶ Select **to Photo Camera** ▶ Press **Options**
- Key Assignments: see **P.6-4**
- Shooting Options: see **P.6-13**





2 Press or

Shutter clicks and image appears.

- Shutter click sounds even in Manner mode.

 To start over, press  **Cancel**.

 To send images, press .

3 Press **Save** to save image

Saving appears and the image is saved.

Viewfinder returns for another shot.

- When **Save Pictures to** is set to **Choice**, select a save location and press .





4 Press to exit

Note ▶ **Self Portrait**

Your image appears on Display as a mirror image. After shutter is released, preview image appears reversed.

- Tip ▶
- Change shutter click sound (see P.6-13). Volume is fixed.
 - Set handset to save captured images automatically (see P.6-18 "Auto Save").

Still Image Functions

Press  or  **Options** to use the following functions:

Picture Settings	Picture Size	Select image size (see P.6-15)
	Exposure	Adjust light metering (see P.6-15)
	Mobile Light	Select mode and colour (see P.6-14)
	Scene	Select according to lighting or subject (see P.6-15)
	Picture Quality	Select Normal , Fine or High Quality (see P.6-16)
Camera Modes	Continuous Shoot	Select mode and speed (see P.6-8)
	Photo Frame	Add Frames (see P.6-10)
	Timer	Set Timer (see P.6-14)
My Pictures		View files in Data Folder (see P.6-18)
to Video Camera		Switch to Video Camera mode (see P.6-18)



Continuous Shoot

Use Continuous Shoot to capture images sequentially.

4 Pictures¹	Capture four separate images
9 Pictures²	Capture nine separate images
Bracket²	Capture nine separate images. Exposure and Mobile Light colour vary slightly for each shot.
Overlapped²	Capture five images to create a composite image

¹Available when Picture Size is **480x640**, **240x320**, **120x160** or **120x128**.

²Available when Picture Size is **240x320**, **120x160** or **120x128**.

- In 4 Pictures, 9 Pictures or Bracket mode, Index Image is created separately (not available when Picture Size is **480x640**).
- In Overlapped mode, a composite image is created in addition to five images.
- Press  or  for the first shot. Handset captures the rest automatically.

In 4 Pictures or 9 Pictures mode, select **Manual** to release shutter manually, or select a shutter speed from five levels.

Tip ▶ From a Continuous Shoot file, select an image to send as an MMS attachment (see **P.6-19**).

Activating Continuous Shoot

Main Menu

▶ Camera ▶ *Activate Photo Camera mode* ▶
Options ( or ) ▶ Camera Modes ▶ Continuous Shoot

1 Select from 4 Pictures to *Overlapped* and press

 or 

▶ To cancel, choose **Off** ▶ Press  or 

2 Select a speed and press or

The corresponding indicator appears (see **P.6-3**) and Viewfinder returns.

- **Manual** is not available for Timer.

Note ▶ In low light or while Mobile Light is on, shooting speed may slow down.

Capturing Continuous Shoot Images

Main Menu ▶ Camera ▶ *Activate Continuous Shoot*

1 Frame image on Display and press \odot or \bullet

The first frame is captured with subsequent frames captured at interval determined by Shooting Speed setting.

- For manual shutter control, repeat Step 1 for each frame.

■ To cancel, press \odot or \leftarrow **Stop**.

- Press \odot or \rightarrow **Save** to save captured images.

■ To cancel during manual shutter control, press \odot or \leftarrow

Stop → Press \odot or \leftarrow **Cancel** (Captured images are deleted.)

2 Index Image or a composite image appears

■ Use \leftarrow , \rightarrow or \odot to toggle between images.

- To save images individually, select an image and proceed to Step 3.

■ To attach images to MMS Mail, press \bullet .

3 To save, press \odot or \rightarrow **Save**

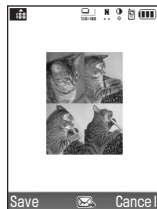

4 Saving All Images

1 Select **All Pictures** and press \odot or \bullet

Viewfinder returns.

- When **Save Pictures to** is set to **Choice**, select a save location and press \odot or \bullet .

Saving a Single Image

1 Select **Selected Picture** and press \odot or \bullet

Viewfinder returns.

- When **Save Pictures to** is set to **Choice**, select a save location and press \odot or \bullet .

Adding Frames

- In addition to Preset Frames, use transparent PNG files obtained via Web or MMS.
- In Continuous Shoot, Frame is added to each image.
- Available when Picture Size is **240x320**, **120x160** or **120x128**.

Main Menu ▶ Camera ▶ *Activate Photo Camera mode* ▶ Options (⊙ or ⊞) ▶ Camera Modes ▶ Photo Frame

1 Preset Frames

1 Select **Preset Frames** and press ⊙ or ⊞

2 Select a Frame and press ⊙ or ⊞

■ To change image (Frame), press ⊙ or ⊞ **Back**.

3 Press ⊙ or ⊞

Original Frames

1 Select **My Pictures** and press ⊙ or ⊞

- Some images may not be used as a Frame.

2 Select a Frame and press ⊙ or ⊞

■ To change image (Frame), press ⊙ or ⊞ **Back**.

3 Press ⊙ or ⊞

Cancelling

1 Choose **Off** and press ⊙ or ⊞

Video

Video Camera Mode

Record short video clips to send via MMS. Use SD Memory Cards to save longer recordings (recording time depends on the card capacity.)

Tip ▶ For best results, record within 1.5 meters.

Picture Size		W 176 x H 144 dots (QCIF) W 128 x H 96 dots (SubQCIF)	W 240 x H 320 dots (QVGA)
Save Location		Handset or SD Memory Card Data Folder (Videos)	SD Memory Card Data Folder (SD VIDEO)
Recording Time (per shot)	For Message	60 seconds (Normal) 50 seconds (Fine) 30 seconds (High Quality)	-
	Extended Video	30 minutes	Capacity-based
Picture Quality		Normal/Fine/High Quality	
Digital Zoom		SubQCIF 3.72x/QCIF 2.72x/QVGA 2x	
Attach to MMS		OK	-
File Format		MPEG-4 (.3gp) ¹	MPEG-4 (.ASF) ²

¹Default file name is also the captured date and time. (Example: **2004-12-15_12-34** indicates the image was captured at 12:34, 15 December 2004.)

File name may change if the same name already exists.

²Default file name starts from **MOL001.ASF** then **MOL002.ASF**, and so on.

- Tip** ▶
- Saving still images, sounds or V-applications reduces memory for video.
 - To check memory status, see **P.10-13**.

Recording Video

Make sure battery is adequately charged and there is enough free memory before recording video. When battery is low (🔋), Video Camera mode is not available. If battery becomes low (🔋) or memory becomes full while recording video, a warning appears and recording stops.

Main Menu ▶ *Camera*

1 Frame image on Display

- When in Photo Camera mode, press Ⓞ or ⏏ **Options** ▶ Select **to Video Camera** ▶ Press Ⓞ or Ⓞ
- Key Assignments: see **P.6-4**
- Shooting Options: see **P.6-13**

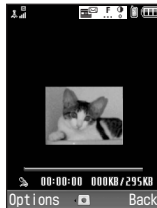

2 Press Ⓞ or Ⓞ

Recording begins after a tone.

- Start and end tones sound even in Manner mode (volume is fixed).

3 To stop, press Ⓞ or Ⓞ

Recording stops with a tone.

- ▶ To play the video, select **Preview** ▶ Press Ⓞ or Ⓞ
- ▶ To start over, press Ⓞ or ⏏ **Back**.

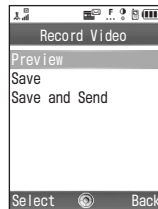

4 To save, select **Save** and press

Ⓞ or Ⓞ

Video is saved and Viewfinder returns for another shot.



- When **Save Videos to** is set to **Choice**, select storage media and press Ⓞ or Ⓞ.

5 Press Ⓞ for 1+ seconds or ⏏ to exit

- Tip** ▶ Actual recording time may differ from that shown on Display.

Video Recording Operations

Before Recording

Press  or  **Options** to use the following functions:

Video Settings	Record Time	Select a format based on recording time and image size (see P.6-16)
	Exposure	Adjust amount of light (see P.6-15)
	Mobile Light	Select mode and colour (see P.6-14)
	Microphone	Set to On to record sounds (see P.6-17)
	Video Quality	Select Normal , Fine or High Quality (see P.6-16)
My Videos		View files in Data Folder (see P.6-18)
To Photo Camera		Switch to Photo Camera mode (see P.6-18)
Advanced	Save Videos to	Select handset or SD Memory Card (see P.6-17)
	Picture Size	Select image size (see P.6-13)
	Video Encode	Select a video encoding format (see P.6-17)
Help		View a summary of key assignments (see P.6-17)

Before Saving

The following menu items appear after recording:

Preview	Play video (see P.6-11)
Save	Save video to handset or SD Memory Card (see P.6-11)
Save and Send	Attach images to MMS Mail (see P.6-19)

Camera Settings

Shooting Options

Toggle Preview Switch Viewfinder size

Photo Camera	Available	Video Camera	N/A
--------------	-----------	--------------	-----

Default Normal Finder

Main Menu ▶ *Camera* ▶ *Activate Photo Camera mode* ▶
Options (Ⓞ or Ⓜ) ▶ *Advanced*

Select **Full Viewfinder** or **Normal Finder** ▶ Press Ⓞ
or ●

Picture Size Select video image size

Photo Camera	N/A	Video Camera	Available
--------------	-----	--------------	-----------

Default Large(QCIF)

Main Menu ▶ *Camera* ▶ *Activate Video Camera mode* ▶
Options (Ⓞ or Ⓜ) ▶ *Advanced* ▶ *Picture Size*

Select **Large(QCIF)** or **Small(SubQCIF)** ▶ Press Ⓞ
or ●

- Large(QCIF): W 176 x H 144 dots
- Small(SubQCIF): W 128 x H 96 dots

Shutter Sound Change shutter click sound

Photo Camera	Available	Video Camera	N/A
--------------	-----------	--------------	-----

Default Pattern 1

Main Menu ▶ *Camera* ▶ *Activate Photo Camera mode* ▶
Options (Ⓞ or Ⓜ) ▶ *Advanced* ▶ *Shutter Sound*

Select a pattern ▶ Press Ⓞ or ●

- Note** ▶
- Volume does not change.
 - Shutter click sound for Continuous Shoot is unique and fixed.

Timer

Release shutter automatically

Photo Camera	Available	Video Camera	N/A
--------------	-----------	--------------	-----

Default/Off

Main Menu

▶ Camera ▶ *Activate Photo Camera mode* ▶
Options (⊕ or ⊖) ▶ Camera Modes ▶ Timer

Activating Timer

Choose **On** ▶ Press ⊕ or ●

- Viewfinder returns (⊗ appears).

Timer Shooting

Press ⊕ or ●

- Tone sounds and shutter is released after 10 seconds.
■ To save images, press ⊕ or ⊖ **Save**.

Timer Details

- To cancel Timer during countdown, press ⊖, ⊞ **Cancel** or **SELECT MENU**.
• Viewfinder returns (Timer setting remains).
- To release shutter manually while Timer is active, press ⊕ or ●. Image is captured and Timer is cancelled.
- Incoming calls and Alarm interrupt image capture.
- While Timer is active, the following settings are not available:
Exposure, Mobile Light and to Video Camera.

Note ▶ Timer is not available when Continuous Shoot is set to **Manual**.

Mobile Light

Select mode and colour

Photo Camera	Available	Video Camera	Available
--------------	-----------	--------------	-----------

Default/Off/White

Main Menu ▶ Camera ▶ *Options (⊕ or ⊖)*

Mobile Light (Still Image)

Select **Picture Settings** ▶ Press ⊕ or ● ▶ Select **Mobile Light** ▶ Press ⊕ or ● ▶ Select **Switch On/Off** ▶ Press ⊕ or ● ▶ Select **On, Auto, Low Light or Off** ▶ Press ⊕ or ●

- Setting returns to default when mobile camera shuts down.

On	Mobile Light activates and brightens for image capture
Auto	Mobile Light activates when light is low and brightens for image capture
Low Light	Mobile Light activates and exposure is constant

Mobile Light (Video)

Select **Video Settings** ▶ Press ⊕ or ● ▶ Select **Mobile Light** ▶ Press ⊕ or ● ▶ Select **Switch On/Off** ▶ Press ⊕ or ● ▶ Select **On, Auto or Off** ▶ Press ⊕ or ●

Colour (Still Image)

Select **Picture Settings** ▶ Press ⊕ or ● ▶ Select **Mobile Light** ▶ Press ⊕ or ● ▶ Select **Light Colour** ▶ Press ⊕ or ● ▶ Select a colour ▶ Press ⊕ or ●

Colour (Video)

Select **Video Settings** ▶ Press ⊕ or ● ▶ Select **Mobile Light** ▶ Press ⊕ or ● ▶ Select **Light Colour** ▶ Press ⊕ or ● ▶ Select a colour ▶ Press ⊕ or ●

Note ▶ Do not use Mobile Light near people's faces or look into the light yourself.

Image Settings

Exposure Adjust light sensitivity for still images and video

Photo Camera	Available	Video Camera	Available
--------------	-----------	--------------	-----------

Default ⓘ (standard)

Main Menu ▶ Camera ▶ Options (⊙ or ⊚)

Still Image

Select **Picture Settings** ▶ Press ⊙ or ● ▶ Select **Exposure** ▶ Press ⊕ or ⊖ ▶ Press ▷/⊙ (brighter) or ◀/⊙ (darker) ▶ Press ⊕ or ⊖

- Setting returns to default when mobile camera shuts down.

Video

Select **Video Settings** ▶ Press ⊕ or ⊖ ▶ Select **Exposure** ▶ Press ⊕ or ⊖ ▶ Press ▷/⊙ (brighter) or ◀/⊙ (darker) ▶ Press ⊕ or ⊖

- Setting returns to default when mobile camera shuts down.

Picture Size Select still image size

Photo Camera	Available	Video Camera	N/A
--------------	-----------	--------------	-----

Default 240x320

Main Menu ▶ Camera ▶ **Activate Photo Camera mode** ▶ Options (⊙ or ⊚) ▶ Picture Settings ▶ Picture Size

Select a size ▶ Press ⊕ or ⊖

- To change video image size, see P.6-13.

Scene Select a mode according to lighting or subject

Photo Camera	Available	Video Camera	N/A
--------------	-----------	--------------	-----

Default Auto

Main Menu ▶ Camera ▶ **Activate Photo Camera mode** ▶ Options (⊙ or ⊚) ▶ Picture Settings ▶ Scene

Select a mode ▶ Press ⊕ or ⊖

- Setting returns to default when mobile camera shuts down.

Auto	Automatic adjustment
Night	Use in low light conditions
Sports	Best suited for action sports or fast-moving subjects
Characters	Most suitable for high contrast black and white subjects

Picture Quality Select image or video quality

Photo Camera	Available	Video Camera	Available
--------------	-----------	--------------	-----------

Default Photo Camera: Normal, Video Camera: Fine

Main Menu ▶ Camera ▶ Options (⊕ or ⊖)

Still Image Quality

Select **Picture Settings** ▶ Press ⊕ or ⊙ ▶ Select **Picture Quality** ▶ Press ⊕ or ⊙ ▶ Select quality ▶ Press ⊕ or ⊙

Video Quality

Select **Video Settings** ▶ Press ⊕ or ⊙ ▶ Select **Video Quality** ▶ Press ⊕ or ⊙ ▶ Select quality ▶ Press ⊕ or ⊙

- Picture Quality setting is not available when Record Time is set to **QVGA(MPEG4)**.

Tip ▶ The image quality increases in the order: **Normal, Fine, High Quality**. Saving higher quality images requires more space in memory and shortens recording time.

Record Time

Select **For Message** to record short video to send via MMS
For longer video recording, select **Extended Video**

Photo Camera	N/A	Video Camera	Available
--------------	-----	--------------	-----------

Default For Message

Main Menu ▶ Camera ▶ **Activate Video Camera mode** ▶ Options (⊕ or ⊖) ▶ Video Settings ▶ Record Time

Long Recording

Select **Extended Video** ▶ Press ⊕ or ⊙ ▶ Select **QCIF/SubQCIF** or **QVGA(MPEG4)** ▶ Press ⊕ or ⊙ twice

- Extended Video** can only be selected when an SD Memory Card is inserted.

QCIF/SubQCIF	Record video in the 3GPP format (extension: .3gp)
QVGA (MPEG4)	Record video in the MPEG-4 format (extension: .ASF) Image size is W 240 x H 320 dots

Short Video Clip

Select **For Message** ▶ Press ⊕ or ⊙

- Record up to 295 KB.

Note ▶ To select storage media, insert SD Memory Card.

Microphone Record sounds when recording video

Photo Camera	N/A	Video Camera	Available
--------------	-----	--------------	-----------

Default On

Main Menu ▶ Camera ▶ *Activate Video Camera mode* ▶
Options (Ⓞ or Ⓜ) ▶ Video Settings ▶ Microphone

Choose **On or Off** ▶ Press Ⓞ or Ⓜ

Video Encode Select a video encoding format

Photo Camera	N/A	Video Camera	Available
--------------	-----	--------------	-----------

Default MPEG4 (Japan)

Main Menu ▶ Camera ▶ *Activate Video Camera mode* ▶
Options (Ⓞ or Ⓜ) ▶ Advanced ▶ Video Encode

Select **H.263(Europe) or MPEG4(Japan)** ▶ Press Ⓞ
or Ⓜ

- Video Encode setting is not available when Record Time is set to **QVGA(MPEG4)**.

Additional Settings

Help

View a summary of key assignments for operations with handset open (clamshell open)

Photo Camera	Available	Video Camera	Available
--------------	-----------	--------------	-----------

Main Menu ▶ Camera ▶ *Options (Ⓞ or Ⓜ)*

Select **Help** ▶ Press Ⓞ or Ⓜ

Save to

Select a save location for image files

Photo Camera	Available	Video Camera	Available
--------------	-----------	--------------	-----------

Main Menu ▶ Camera ▶ *Options (Ⓞ or Ⓜ)* ▶ Advanced ▶
Save Videos to/Save Pictures to

Select **Handset Memory, Memory Card or Choice** ▶
Press Ⓞ or Ⓜ

For Images Larger than W 480 x H 640 Dots

Select **Handset Memory, SD(Pictures), SD(DCIM) or Choice** ▶ Press Ⓞ or Ⓜ

- For **Choice**, select a save location each time you save.
- To select storage media for video, set Record Time to **For Message**.

Note ▶ To select storage media, insert SD Memory Card.

Select Mode

Switch between Photo Camera and Video Camera modes

Photo Camera	Available	Video Camera	Available
--------------	-----------	--------------	-----------

Main Menu ▶ Camera ▶ Options (⊙ or ⊲)

Select to **Video Camera** or to **Photo Camera** ▶ Press ⊕ or ⊙

Auto Save

Set handset to save captured images automatically

Photo Camera	Available	Video Camera	N/A
--------------	-----------	--------------	-----

Default Off

Main Menu ▶ Camera ▶ Activate Photo Camera mode ▶ Options (⊙ or ⊲) ▶ Advanced ▶ Auto SaveChoose **On** or **Off** ▶ Press ⊕ or ⊙

Opening Images & Playing Video

Opening Still Images

Main Menu ▶ Camera ▶ Activate Photo Camera mode ▶ Options (⊙ or ⊲)

- 1 Select My Pictures and press ⊕ or ⊙**
 - When SD Memory Card is inserted, select **Pictures** or **Camera Images** ▶ Press ⊕ or ⊙
- 2 Select an image and press ⊕ or ⊙**
 - To open other files, press ⊙ or ⊲ **Back**.
 - To open images on SD Memory Card, press ⊙.

Tip ▶ Open a file and press ⊕ for 1+ seconds or ⊲ **Options** to use available functions.

Playing Video

Main Menu ▶ Camera ▶ Activate Video Camera mode ▶ Options (⊙ or ⊲)

- 1 Select My Videos and press ⊕ or ⊙**
- 2 Select a file and press ⊕ or ⊙**
 - To play other files, press ⊙ or ⊲ **Back**.
 - To play files on SD Memory Card, press ⊙.

QVGA Size Images Play QVGA size video (W 240 x H 320 dots)**Main Menu** ▶ Media Player

Press ⊕ (Long Press) or ⊲ **Options** ▶ Select **Open Video** ▶ Press ⊕ or ⊙ ▶ Select **SD VIDEO** ▶ Press ⊕ or ⊙ ▶ Select a file ▶ Press ⊕ or ⊙

Sending Still Images & Video

Still Images

Capture and send images as MMS attachments.

- To attach Continuous Shoot images, use  to select a frame or Index Image.
- To attach images in Data Folder, see P.8-4.

1 Before saving image (see P.6-6 - P.6-7), press 

2 Select a save location and press 

Image is saved to Data Folder and New Message window opens with image attached.

- New Message window may open directly after Step 1 depending on the settings.

3 Complete other fields and send MMS Mail (see P.14-6)

Tip ▶ For information about Messaging service and compatibility with other handset models, contact Vodafone Customer Centre, General Information (see P.16-32).

Video Clips

Send video clips via MMS.

To attach video files in Data Folder, see P.8-4.

1 Before saving video (see P.6-11), select *Save and Send* and press 

Video is saved to Data Folder and New Message window opens with image attached.

- When *Save Videos to* is set to *Choice*, select storage media and press .

2 Complete other fields and send MMS (see P.14-6)

Note ▶ • Send video clips to MMS/VGS compatible Vodafone Handsets that support MPEG-4 video playback.

Tip ▶ For information about Messaging service and compatibility with other handset models, contact Vodafone Customer Centre, General Information.

Media Player

Media Player

Use Media Player to listen to music (Music Player) or play video (Video Player). Save video/music files to handset or SD Memory Card (including SD VIDEO and SD AUDIO). To open files, specify the location first.

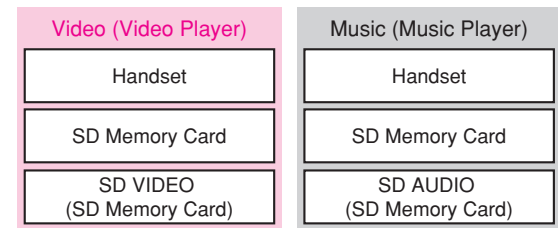

When Manner Mode is Active

Manner mode active. Output sound? appears when starting Media Player.

- Press **Yes** to cancel Manner mode temporarily. Handset speaker outputs sound at the volume set for Media Player.
- Press **No** to stay in Manner mode. Enjoy sound discretely with Multi Stereo Headphones, etc.

Tip ▶ Play video/music while downloading them (Streaming: see P.13-14).

Playlist

Select and open video/music files from Video Playlist or Music Playlist. In Video/Music Playlist, all files in one location appear in **All Videos/All Music**. Create original **Playlist** to organise them.

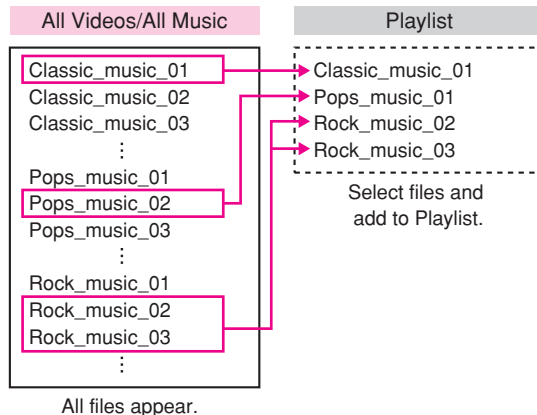

All files appear.

- Once video/music is played, the Playlist used last will open next time.
- Playlist stores only file locations. The source files are in the original locations.
- Create new Playlists (see P.7-11).
- Three video/music Playlists are set by default.



Playing Music

Record tracks in Secure MP3 format from CD players, PC hard disks, etc. to SD Memory Card. Music Player is not compatible with some recording/playback formats. Music may not play depending on the SD Memory Card status.

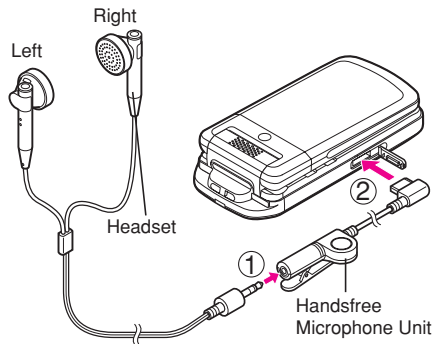
- Play downloaded music.
- Connect Headphones as shown below.
- Alternatively, use handset speaker.



Precautions

- Hold Handsfree Microphone Unit when connecting or disconnecting Headset. Do not handle Headphones roughly to avoid damaging Headphone Connector or cord.
- Use only the supplied Headphones. Other devices may not function properly and damage may result.
- When battery is low (), Music Player does not play. If battery becomes low () during playback, Music Player shuts down and Standby returns automatically.
- Turn down the volume if handset speaker sound is distorted.

Tip ▶ To answer calls during playback with Headphones, press Call Button for 1+ seconds.

Playback Window (Music Player)

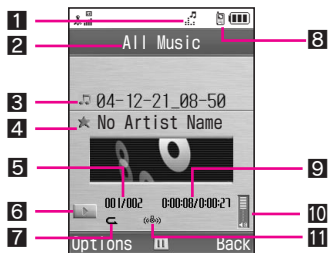

1 Playback in Progress

2 Playlist Name

3 Title

4 Artist Name

- **No Artist Name** appears if not available.

5 Track Number

6 Status

▶: Play, ■: Stop, ⏮: FF, ⏭: FR

7 Playback Pattern (see P.7-6)

⏮: Repeat, ⏮: Repeat All, ⏮: Random

- No indicator: Playback Pattern **Normal**

8 Track Location

9 Elapsed Time

10 Volume

11 Sound Effect (Tone Control: see P.7-5)

🔊: Bass (increase bass), 🎧: Surround

🎧: Surround Bass

- No indicator: Tone Control **Normal**

Playback

Main Menu ▶ Media Player ▶ Options (⌂) ▶ Open Music

1 Select **Handset Memory**, **Memory Card** or **SD AUDIO** and press **⏪**

2 Select **Playlist** and press **⏪**

- For Music Playlist, see P.7-11.

To search tracks, press **⌂ Options** ▶ Select **Search** ▶ Press **⏪** ▶ Enter search text ▶ Press **⏪**

To sort tracks, press **⌂ Options** ▶ Select **Sort** ▶ Press **⏪** ▶ Select a sort option ▶ Press **⏪**

- Tracks in SD AUDIO cannot be sorted.

To check track properties, select a track ▶ Press **⌂ Options** ▶ Select **Information** ▶ Press **⏪**

3 Select a track and press **⏪**

- Playback stops after the last track when Playback Pattern is set to **Normal** (see P.7-6).

To pause playback, press **⏪**.

Use **⏮** (up) or **⏭** (down) to adjust volume.

To mute, press **⏮** for 1+ seconds.

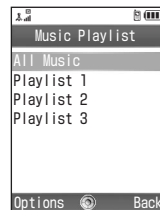

Incoming Calls/Mail during Playback





- Playback stops for incoming calls or Alarm.

- An icon appears for incoming mail without interrupting playback.

- When playback stops while Streaming, the URL is saved to Access History.

Tip ▶ If sound is distorted, decrease volume or adjust other Tone Control options.

Playback Operations

Replay	Press  Press repeatedly to play previous tracks. ¹
Skip	Press  Press repeatedly to skip more. ²
Fast Forward	Press and hold  Release for playback.
Fast Reverse	Press and hold  Release for playback.
Pause	Press  Press again to resume playback.

¹In Random Play,  only replays the current track.

²Unavailable for the last track when Playback Pattern is set to **Normal**.

Additional Operations

Create mail messages and use Phone Book, etc. during playback; however, some functions are not available.

Tip ▶ **Stop music?** appears when  is pressed in Standby.

Playback Settings

Tone Control Increase bass for dynamic sound or enjoy surround sound

Default: Normal

Main Menu ▶ *Media Player* ▶ *Open Playback window* ▶
Options () ▶ *Tone Control*

Select an effect ▶ **Press** 

Normal	No sound effects
Bass	Increase bass
Surround	Surround effect
Surround Bass	Surround with increased bass

Note ▶ Bass effect is not available for handset speaker sound.

Playback Pattern

Repeat tracks or play them in random order

- Set to Repeat (one track repeat) while track information is on Display. Default Normal

Main Menu ▶ *Media Player* ▶ *Open Playback window* ▶ *Options* (⏏) ▶ *Playback Pattern*

Select a pattern ▶ Press (⏏)

Normal	Play in order until the last track ends
Repeat	Repeat one track
Repeat All	Repeat all tracks
Random	Play in random order

Playing Video

Play video recorded with mobile camera or files downloaded via Web or Mail. Sounds play from the handset speaker. Alternatively, use Headphones to listen (see P.7-3).

Playback Window (Video Player)

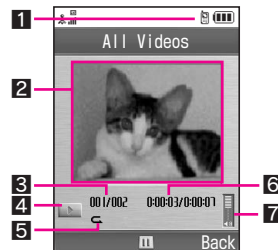
**1** Clip Location**2** Video Image/Subtitles**3** Clip Number**4** Status

▶: Play, ⏏: Pause, ⏏: FF, ⏏: FR

5 Playback Pattern (see P.7-7)

- ⏏: Repeat, ⏏: Repeat All, ⏏: Random
- No indicator: Playback Pattern **Normal**

6 Elapsed Time**7** Volume

Playback

Main Menu ▶ *Media Player* ▶ *Options (D)* ▶ *Open Video*

1 Select **Handset Memory**, **Memory Card** or **SD VIDEO** and press **⊙**

2 Select **Playlist** and press **⊙**

For Video Playlist, see **P.7-11**.

To search video clips, press **D** **Options**
▶ Select **Search** ▶ Press **⊙** ▶ Enter search text ▶ Press **⊙**

To sort video clips, press **D** **Options** ▶ Select **Sort** ▶ Press **⊙** ▶ Select a sort option ▶ Press **⊙**

To check clip properties, select a clip ▶ Press **D** **Options** ▶ Select **Information** ▶ Press **⊙**
▪ Press **⏪** to return.

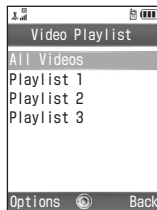

3 Select a clip and press **⊙**

Playback window opens.

Playback stops after the last clip when Playback Pattern is set to **Normal** (see right).

To pause playback, press **⊙**.

Use **⏮** (up) or **⏭** (down) to adjust volume.

To mute, press **⏭** for 1+ seconds.

Playback Operations: see **P.7-5**

Tip ▶ For frame advance, pause playback and press **⏮** for 1+ seconds.

Playback Settings

Playback Pattern Repeat clips or play them in random order

Default: Normal

Main Menu ▶ *Media Player* ▶ *Pause playback* ▶ *Options (D)*
▶ *Settings* ▶ *Playback Pattern*

Select a pattern ▶ Press **⊙**

Backlight Select a Backlight status for playback

Default: Always On

Main Menu ▶ *Media Player* ▶ *Pause playback* ▶ *Options (D)*
▶ *Settings* ▶ *Backlight*

Select a pattern ▶ Press **⊙**

Always On	Backlight remains on during playback
Always Off	Backlight does not turn on during playback
Normal Settings	Backlight turns on/off depending on Backlight setting (see P.10-6)

Display Size Change playback size

Default: Enlarge

Main Menu ▶ *Media Player* ▶ *Pause playback* ▶ *Options (D)*
▶ *Settings* ▶ *Display Size*

Select a size ▶ Press **⊙**

Editing Video

Select Two Points	Crop portion between two points to save as a new file
Delete Before	Portion after a selected frame is saved as a new file
Delete After	Portion before a selected frame is saved as a new file
Edit Subtitle	Add subtitles (text) to video

- Note** ▶
- Some files may not be edited.
 - Edited video may not play properly if SD Memory Card is not formatted for 802SH.
 - To save to SD Memory Card, a maximum of 320 KB of free memory is required in addition to the file size.

Selecting Start and End Points

Main Menu ▶ *Media Player* ▶ *Pause playback* ▶ *Options (⏏)*
▶ *Edit*

- 1 Press** **Yes**
 - Incoming transmissions are blocked during editing.
- 2 Select *Crop* and press**
- 3 Select *Select Two Points* and press**
- 4 Press** **Start** **at the start point**
The start point is specified and playback resumes.
- 5 Press** **End** **at the end point**
The portion is saved.

Cropping Video Clips

Delete the portion before or after the selected frame to save the rest as a new file.

Main Menu ▶ *Media Player* ▶ *Pause playback* ▶ *Options (⏏)*
▶ *Edit*

- 1 Press** **Yes**
 - Incoming transmissions are blocked during editing.
- 2 Select *Crop* and press**
- 3 Select *Delete Before* or *Delete After* and press**
- 4 Press** **Cut** **to select a frame**
 - The portion before or after the selected frame is deleted.
 To cancel, press **Back**.

Editing Subtitles

Set subtitles to appear during video playback.

- Select the timing, change the colour and size, or add effects.
- Use Video Player to edit subtitles.

Entering Text

After entry, set timing and time period for subtitles. Save up to ten subtitles of up to 48 single-byte alphanumeric per entry.

Main Menu ▶ Media Player ▶ Pause playback ▶ Options (⏏)
▶ Edit

- 1 Press **Yes**
 - Incoming transmissions are blocked during editing.
- 2 Select **Subtitle** and press **Enter**
- 3 Select **Edit Subtitle** and press **Enter**
- 4 Select a number and press **Enter**
- 5 Enter text and press **Enter**

Playback starts.
- 6 Press **Start** at the start point
- 7 Press **End** at the end point
 - ▶ To edit subtitles, select **Edit Text** ▶ Edit ▶ Press **Enter**
 - ▶ For Display Settings and Text Effects, see right and P.7-10.

8 After completing all the settings, press **Set** and then **End**

9 Select **Overwrite** or **Create New** and press **Enter**

Display Settings

Duration Set timing and time period for subtitles

Main Menu ▶ Media Player ▶ Pause playback ▶ Enter subtitles ▶ Display Settings ▶ Duration

Press **Start** at the start point ▶ Press **End** at the end point

Display Position Set position for subtitles to appear

Main Menu ▶ Media Player ▶ Pause playback ▶ Enter subtitles ▶ Display Settings ▶ Display Position

Use **Directional Pad** to select a position ▶ Press **Enter**

Font Size Change font size of subtitles

Default Handset (20 x 20)

Main Menu ▶ Media Player ▶ Pause playback ▶ Enter subtitles ▶ Display Settings ▶ Font Size

Select **Handset (20 x 20)** or **PC (12 x 12)** ▶ Press **Enter**

Scrolling

Select direction and visual effect for subtitle scroll

Default Direction: Left to Right, Effect: Frame In

Main Menu

Media Player → Pause playback → Enter subtitles → Display Settings → Scrolling

Direction

Select **Direction** → Press → Select **Left to Right** or **Right to Left** → Press

Effect

Select **Effect** → Press → Select an effect → Press

Frame In	Subtitle comes in from the frame end
Frame Out	Subtitle appears in the centre and scrolls out
Rolling	Subtitle scrolls from end to end

On-Screen Time

Select **On-Screen Time** → Press → Enter time → Press

Background Colour

Select from seven background colours

Default Black

Main Menu

Media Player → Pause playback → Enter subtitles → Display Settings → Background Colour

Select a colour → Press

Adding Text Effects

Font Colour

Change font colours

Default White

Main Menu

Media Player → Pause playback → Enter subtitles → Text Effects → Font Colour

All

Select **All** → Press → Select a colour → Press

Select Portion

Select **Select Text** → Press → Use to select the first character → Press → Use to select the last character → Press → Select a colour → Press

Highlight

Highlight subtitles

Main Menu

Media Player → Pause playback → Enter subtitles → Text Effects → Highlight

Use to select the first character → Press → Use to select the last character → Press → Select a colour → Press

Blink

Set subtitles to flash

Main Menu

Media Player → Pause playback → Enter subtitles → Text Effects → Blink

Use to select the first character → Press → Use to select the last character → Press

Reset Effects

Cancel all Text Effects

Main Menu

Media Player → Pause playback → Enter subtitles → Reset Effects

Press **Yes**

Deleting All Subtitles

Main Menu ▶ Media Player ▶ Pause playback ▶ Open Subtitle options ▶ Delete All Subtitle

1 Press **Yes**

Managing Video & Music Files

Organise video/music files on handset in **Video Playlist** and **Music Playlist**. Create original Playlists to group clips or categorise tracks.

- Access all video/music files from **All Videos/All Music** (preset list).
- To save to SD Memory Card, a maximum of 320 KB (video) or 96 KB (music) of free memory is required in addition to the file size.

Adding New Playlist

Create Playlists in **Video Playlist** or **Music Playlist**. Playlists cannot be added into **SD VIDEO**.

Main Menu ▶ Media Player ▶ Open Video/Music Playlist window ▶ Options ▶ Add New Playlist

1 Enter name and press

The Playlist is added.

Deleting Playlist

Press ▶ Select **Media Player** ▶ Press ▶ Press **Options** ▶ Select **Open Music** or **Open Video** ▶ Press ▶ Select **Handset Memory, Memory Card** or **SD AUDIO/SD VIDEO** ▶ Press ▶ Select **Playlist** ▶ Press **Options** ▶ Select **Delete Playlist** ▶ Press ▶ Press **Yes**

- Source files in **All Videos/All Music** remain.

■ The default Playlists can be deleted.

Editing List Name

Press ▶ Select **Media Player** ▶ Press ▶ Press **Options** ▶ Select **Open Music** or **Open Video** ▶ Press ▶ Select **Handset Memory, Memory Card** or **SD AUDIO/SD VIDEO** ▶ Press ▶ Select **Playlist** ▶ Press **Options** ▶ Select **Edit List Title** ▶ Press ▶ Enter new name ▶ Press

■ The default Playlist can be renamed.

Adding Clips/Tracks

Add video/music from **All Videos/All Music** to newly created Playlist.

- Playlist stores only file locations. The source files will not be copied.
- Video files in **SD VIDEO** cannot be added.

Main Menu ▶ Media Player ▶ Open All Videos/All Music

- 1 Select a file and press Options
- 2 Select **Add to Playlist** and press
- 3 Select Playlist and press

Deleting Clips/Tracks in Playlist

Open Video/Music Playlist window and follow these steps.

Select Playlist ▶ Press ▶ Select a clip/track ▶
 Press Options ▶ Select **Delete** ▶ Press ▶
 Press Yes

- Source files in **All Videos/All Music** remain.

Changing Order

Follow these steps to rearrange the order in Playlist.

Select Playlist ▶ Press ▶ Select a clip/track ▶
 Press Options ▶ Select **Change Order** ▶ Press
 ▶ Use to select a location ▶ Press

Deleting Files in SD VIDEO & SD AUDIO

Delete files in **SD VIDEO** or **SD AUDIO**. (Source files will be deleted.)

Main Menu ▶ Media Player ▶ Open All Videos/All Music

- 1 Select a file and press Options
- 2 Select **Delete** or **Delete Track** and press
- 3 Press Yes

Managing Files

Data Folder



File Organisation

Data Folder Contents

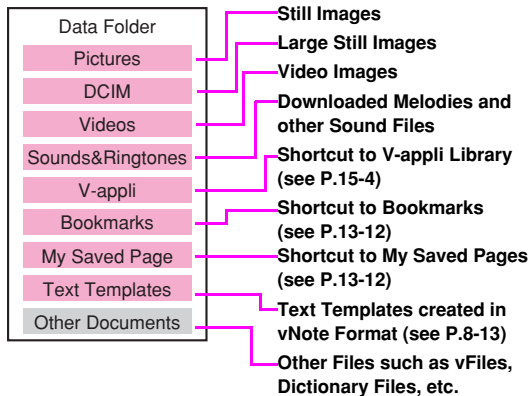
Saved files are organised in separate folders according to file format.



Window Description

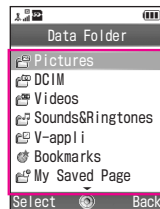

To open Data Folder, press  in Standby, select **Data Folder** and press .



Default Folders

Major Icons

Still Image & Animation Files



Icon	Format & Extension	Description
	JPEG (.jpg)	JPEG image
	PNG (.png)	PNG image
	E-Animation (NEVA) (.nva)	Animation (may include sound)

Video Files

Icon	Format & Extension	Description
	MPEG-4 (.3gp)	3GPP video image
	MPEG-4 or H.263 (.3gp or .mp4)	3GPP video image

Sound Files

Icon	Format & Extension	Description
	SMAF (.mmf)	Melody via Web or MMS (may include images)
	Audio (.mp4)	Downloaded Chaku-Uta
	Voice (.amr)	Voice/sound recorded on Voice Recorder

Tip ▶  appears for copyright protected files.  appears for files in the public domain.

Memory Card

Save files directly to SD Memory Card. Exchange files between handset and Memory Card, or back-up handset files by type.

Sorting Files

Sort by name, date, size or type.

Main Menu ▶ *Data Folder* ▶ *Select a folder* ▶ *Options (⌂)* ▶ *Advanced* ▶ *Sort*

1 Select an item and press

Note ▶ It may take a while to sort many files.

Opening Files

Main Menu ▶ Data Folder

1 Select from *Pictures to Other Documents* and press **⊙**

File list appears.

- To select a file in a created sub folder, select the sub folder and press **⊙**.
- To sort files by date, name, size or type, see P.8-3.
- To open SD Memory Card Data Folder, press **⊙**.

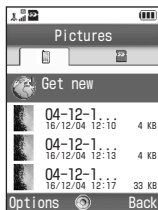

2 Select a file and press **⊙**

The content plays or appears.

- For files in Pictures folder, press **⊙** to zoom in on image. Alternatively, press **⊏ Options**, select **Zoom** and press **⊙**. Press **⊙** repeatedly to zoom in more.
- To return to original scale, press **⊏ Options** ▶ Select **Zoom Out** ▶ Press **⊙**

3 Press **⊏ CLEAR BACK** to return to file list

Tip ▶ Exchange files via Bluetooth or infrared with compatible Vodafone handsets (see P.9-2).

Activating Mobile Camera

Open file list in Pictures, DCIM, or Videos folder and follow the steps below. Mobile camera activates in Photo Camera mode from Pictures and DCIM folders, or in Video Camera mode from Videos folder.

Press **⊏ Options** ▶ Select **Take Picture or Record Video** ▶ Press **⊙**

- If **Get new** is highlighted, press **⊙** first.

Activating Voice Recorder

Open file list in Sounds & Ringtones folder and follow these steps:

Press **⊏ Options** ▶ Select **Record Sound** ▶ Press **⊙**

- If **Get new** is highlighted, press **⊙** first.

MMS Mail Attachments

Attach files to MMS Mail from Data Folder.

Main Menu ▶ Data Folder ▶ *Select a folder*

1 Select a file and press **⊏ Options**

2 Select **Send** and press **⊙**



- For files in Text Templates folder, select **Send Template** and press **⊙**. Skip ahead to Step 4.

3 Select **As Message** and press **⊙**

4 Enter text, recipient, etc., and send MMS Mail (see P.14-6)

Properties

Main Menu ► Data Folder ► *Select a folder*

- 1 Select a file and press  **Options**
- 2 Select **Details** and press 

Press  to scroll down.

- The following information appears:

File name, type, size, last modified date, vendor, copy/forward protection and other restrictions (number of times to open, expiry date/term).











SVG Files

802SH supports SVG-T (Scalable Vector Graphics-Tiny).

View graphics in SVG files, including tables and maps.

For more information on SVG-T, visit

<http://www.sharp.co.jp/j/> (Japanese only).

Scroll	 (Up),  (Left),  (Right),  (Down)
Zoom	 (Zoom Out),  (Zoom In),  (100%)
Rotate	 (Anticlockwise),  (Clockwise)
Key Action Mode	

Tip ► Some features may not be available depending on the SVG file.



Using Files

Use Data Folder files as Wallpaper, Phone Book Picture, Ringtone and Ringvideo.

- **Set as Wallpaper, Add to Ph.Book, as Ring Video** and **Set as Ringtone** can be selected only for compatible files.
- Some files may not be used depending on the size.



Wallpaper

Main Menu ► Data Folder ► *Pictures*

- 1 Select a file and press  **Options**
- 2 Select **Set As Wallpaper** and press 
- 3 Press 
Wallpaper is set.

Phone Book Picture



Main Menu ► Data Folder ► *Select a folder*

- 1 Select a file and press  **Options**
- 2 Select **Add to Ph.Book** and press 
 For more, see Step 4 in "Saving from Dialed Numbers/Received Calls" on P.4-6.

Ringvideo & Ringtone

Ringvideo

Main Menu ▶ Data Folder ▶ Videos

- 1 Select a file and press  **Options**
- 2 Select as *Ring Video* and press 

Ringtone

Main Menu ▶ Data Folder ▶ Sounds&Ringtones

- 1 Select a file and press  **Options**
- 2 Select *Set as Ringtone* and press 

Editing Images

Edit images in Pictures folder. Change size, add effects or combine images.

Changing Image Size

Resize images in Pictures folder to use for Wallpaper, Alarm, etc.

- Alternatively, crop image for size.
- File size changes when images are resized.
- Images may not appear depending on the size.
- **Resize** can be selected only for compatible files.

Resize to Preset Size

Main Menu ▶ Data Folder ▶ Pictures

- 1 Select a file and press **Options**
- 2 Select **Resize** and press
- 3 Select from **To Wallpaper to Alarm** and press

Image appears with a rectangle indicating display size, except for Power On/Off.

- Use to specify display area. (Display area may not be specified depending on image size.)

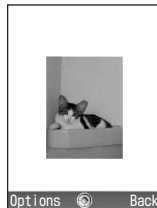

Wallpaper	W 240 x H 290 dots
Power On/Off	W 240 x H 320 dots
Incoming Call	W 176 x H 144 dots
Alarm	W 240 x H 104 dots

- To enlarge or reduce image, press **Options** ▶ Select **Resize** ▶ Press ▶ Press (enlarge) or (reduce) ▶ Press

- To start over from selecting preset size, press **Back**.

- 4 Press
- 5 Press

Image is saved to Data Folder as a new entry. File name is the date and time of entry.

Cropping Images





Main Menu ▶ Data Folder ▶ Pictures

- 1 Select a file and press **Options**
 - 2 Select **Resize** and press
 - 3 Select **Cut** and press
 - 4 Use to move + to the upper left corner of the portion to crop and press
 - 5 Use to move + to the lower right corner of the portion to crop and press
- To start over, press **Options** ▶ Select **Size** ▶ Press
- 6 Press
 - 7 Press



Image is saved to Data Folder as a new entry. File name is the date and time of entry.



Enlarging/Reducing Image



Main Menu ▶ Data Folder ▶ Pictures

- 1 Select a file and press  **Options**
- 2 Select **Picture Editor** and press 
- 3 Select **Enlarge/Reduce** and press 
- 4 Press and hold  to enlarge and  to reduce the size

To stop resizing, release the key (stops automatically when the limit is reached).

■ To centre the point to enlarge, press  **Options** ▶ Select **Move** ▶ Press  ▶ Use  to move the point to the middle of Display

■ To return to enlarge or reduce image, press  **Options** ▶ Select **Resize** ▶ Press 

■ To soften image, press  **Options** ▶ Select **Soft** ▶ Press 

- 5 Press 





Image is saved to Data Folder as a new entry. File name is the date and time of entry.

Visual Effects

Dress up images with pre-loaded visual effects.

- Apply to JPEG images including Continuous Shoot images.
- **Retouch** can be selected only for compatible files.
- Use images between W 52 x H 52 and W 240 x H 320 dots. Images larger than W 240 x H 320 dots are automatically cropped and centred.

Main Menu ▶ Data Folder ▶ Pictures

- 1 Select a file and press  **Options**
- 2 Select **Picture Editor** and press 
- 3 Select **Retouch** and press 
- 4 Select an effect and press 

Sepia	Sepia tone
Sparkling	Bright parts sparkle
Ripples	Widening rings
Tile	Brick frame
Emboss	Embossing effects in metallic silver
Oil Painting	Unique blurring
Clear Frame	3D transparent frame
Round Frame	Translucent white frame (round)
Soft Frame	Translucent white frame (square)
Zigzag Frame	Randomly torn frame

5 Press

Image is saved to Data Folder as a new entry. File name is the date and time of entry.

Note ▶ Decorated images may be too large to save or send via MMS.

Face Arrange

Make smiley, angry or sad faces.

- Apply to JPEG images.
- **Face Arrange** can be selected only for compatible files.
- Face Arrange may not fit all images. Adjust position and size as required (see P.8-10).

Main Menu ▶ Data Folder ▶ Pictures

1 Select a file and press  **Options**

2 Select **Picture Editor** and press 

3 Select **Face Arrange** and press 

4 Select a type and press

Mirror: Right-half	Right side of face
Mirror: Left-half	Left side of face
Grin	Eyes and mouth of a smiling face
Mad	Eyes and mouth of an angry face
Sad	Eyes and mouth of a sad face
Big Eyes	Add graphic eyes
Burning Eyes	Add flames in the eyes
Crying	Add tears
Aristocrat	Add a monocle and moustache
Angry Mark	Add a stress mark

▶ To check current positions of targets, select **Positioning** ▶ Press 

▪ Press  **Back** to return.

▶ To start over, press  **Back**.

5 Press

Image is saved to Data Folder as a new entry. File name is the date and time of entry.

Note ▶ When using Face Arrange, take care not to create images that may embarrass or offend others. Always obtain permission before photographing others.

Adjusting Face Arrange Position

Change the default positions and sizes of targets to fit the image. Changes apply to the current image only.

1 In Step 4 on P.8-9, select **Positioning** and press **○**

2 Press **▷** **Modify**

A rectangle appears with + in the upper left corner.

3 Set the face line

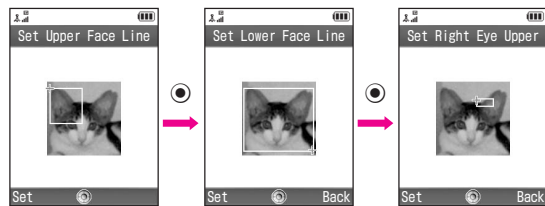

Use **○** to move + to the upper left corner

Use **○** to move + to the lower right corner

Face line is set

To start over, press **◀** **Back**.

4 Set the eyes and then mouth in the same way

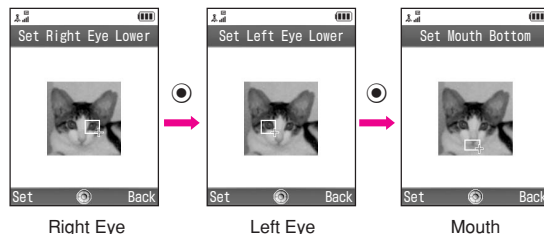

Right Eye

Left Eye

Mouth

5 Press **○** or **▷** **Set** when finished

All the targets appear.

To start over from the face line, return to Step 2.

To restore the default positions, press **◀** **Back**.

6 Press **○**

7 Press **▷** **Yes**

Image is saved to Data Folder as a new entry.

- Face Arrange is applied to the adjusted positions.

Panorama Images

Combine two images into one.

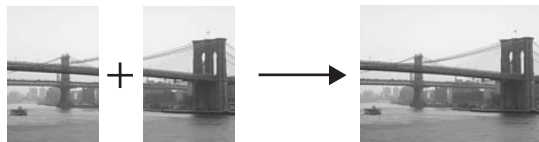

Select two images

Merge Panorama

Panorama Image Effects:

Standard	Applicable to all kinds of shots
Near View	Best suited for close-up shots with parallax correction
Document	Use for images with text

- Use JPEG images between W 48 x H 64 and W 120 x H 160 dots/W 160 x H 120 dots.
- Some portions may be cropped to adjust two images to the same size.
- The result may not be satisfactory if colour tones are different between two images.
- **Merge Panorama** can be selected only for compatible files.

Main Menu ▶ Data Folder ▶ Pictures

1 Select the first image and press **Options**

- This image appears on the left when combined.

- 2** Select **Picture Editor** and press **Options**
- 3** Select **Merge Panorama** and press **Options**
- 4** Select **Second Image** and press **Options**
- 5** Select another image and press **Options**
- 6** Press **Options**, select **Select Effect** and press **Options**
- 7** Select from **Standard** to

Document and press **Options**

- If the image is too large or too small, change it.

■ To check images, select either ▶

Press **Options**

- Press **Back** to return.

■ To change images, select either ▶

Press **Options** ▶ Press **Options** ▶ Select

Change ▶ Press **Options** ▶ Select an image

8 Press **Options** when finished

9 Select **Save** and press **Options**

10 Press **Options**

Image is saved to Data Folder as a new entry. File name is the date and time of entry.

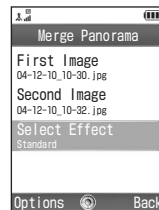

Split Screen

Combine up to four reduced images into one.

- Apply to JPEG and PNG images.
- Make sure there is enough free memory.
- The four images are placed in the following order: upper left, upper right, lower left and lower right.



Split Picture

Main Menu ▶ *Data Folder* ▶ *Pictures*

- 1** Select the first image and press **Options**
- 2** Select *Picture Editor* and press **Enter**
- 3** Select *Split Picture* and press **Enter**
- 4** Select *Create 120x160* or *Create 240x320* and press **Enter**
- 5** Enter name and press **Enter**
 - Enter up to 24 characters.
- 6** Select *Second Image* and press **Enter**
- 7** Select an image and press **Enter**

Image opens (compatible ones only).

 - To change image after Step 7, press **Options** ▶ Select *Change* ▶ Press **Enter** ▶ Select an image

8 Press **Enter**

9 Repeat Steps 6 - 8 to add images

- In Step 6, select *Third Image* or *Fourth Image* and press **Enter**.

- To preview Split Image, press **Options** ▶ Select *View* ▶ Press **Enter**
- To change images, select one ▶ Press **Options** ▶ Select *Replace* ▶ Press **Enter** ▶ Start over from Step 7 - 8
- To delete images, select one ▶ Press **Options** ▶ Select *Remove* ▶ Press **Enter** ▶ Press **Options** ▶ Select *Yes*

10 Press **Options** when finished

- To cancel, press **Back**

11 Select *Save* and press **Enter**

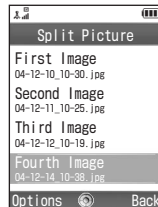

Additional Picture Effects

Some menu items can only be selected for compatible files.

Reformat file Convert JPEG to PNG, and vice versa

Main Menu ▶ Data Folder ▶ Pictures

Select a file ▶ Press **Options** ▶ Select **Picture Editor** ▶ Press **Reformat file** ▶ Press **Select a format** ▶ Press

- The original format cannot be selected.

Tip ▶ Changing file format may affect image size/quality.

Add Frame Add Frame to JPEG images

Main Menu ▶ Data Folder ▶ Pictures

Select a file ▶ Press **Options** ▶ Select **Picture Editor** ▶ Press **Add Frame** ▶ Press **Select a Frame** ▶ Press twice

Press **Back** to return to Frame list.

Rotate Rotate images

Main Menu ▶ Data Folder ▶ Pictures

Select a file ▶ Press **Options** ▶ Select **Picture Editor** ▶ Press **Rotate** ▶ Press

*To rotate further, press **Rotate**. Each press rotates image by 90 degrees.

Text Templates

Save frequently used phrases for use in mail message.

Save up to 50 entries of up to 256 characters each. (Maximum number of entries may be less depending on contents.)

New Entry

Main Menu ▶ Data Folder ▶ Text Templates ▶ Add New Template

1 Enter text and press

Editing Templates

Main Menu ▶ Data Folder ▶ Text Templates

- 1** Select a file and press **Options**
- 2** Select **Edit** and press
- 3** Edit text and press

Deleting Templates

Delete single Text Templates.

Main Menu ▶ Data Folder ▶ Text Templates

- 1** Select a file and press **Options**
- 2** Select **Delete** and press
- 3** Press **Yes**

Editing Files & Folders

Adding Folders

Assign different names to folders within a layer.

Main Menu ▶ Data Folder

1 Select from *Pictures to Other Documents* and press

- Folders cannot be added to DCIM, V-appli, My Saved Page and Text Templates folders.

2 Select any file and press Options

- Shortcut: In Pictures, Videos or Sounds & Ringtones folder, select **Get new** and skip ahead to Step 4.
- For Bookmarks folder, after Step 2, select **New** ▶ Press ▶ Select **Folder** ▶ Press ▶ Skip ahead to Step 5

3 Select *Advanced* and press

4 Select *Create Folder* and press

5 Enter name and press

6 Press OK

Changing File Names

- File extensions do not change.
- Assign different names to files within a layer.
 - Single-byte Symbols ¥, /, :, ;, ,, <, >, /, ?, *, ", and Pictographs are not supported.
- Make sure there is enough free memory.

Main Menu ▶ Data Folder ▶ Select a folder

1 Select a file and press Options

2 Select *Rename* and press

3 Enter name and press

4 Press OK

Deleting Files & Folders

- Delete folder contents before deleting folders.
- Files in V-appli, Bookmarks, My Saved Page and Text Templates folders can only be deleted one at a time.

Main Menu ▶ Data Folder

1 Select from *Pictures to Other Documents* and press

2 *Deleting Folders*

1 Select a folder and press Options

Deleting Single Files

1 Select a file and press Options

Deleting Multiple Files

1 Press Options

2 Select *Advanced* and press

3 Select *Multiple Select* and press

4 Select a file and press

- ✓ appears. To cancel, press again.

5 Repeat Step 4

- To check or uncheck all files at once, see P.8-15.

6 Press Options

3 Select *Delete* and press

4 Press Yes

All Files

Files in use for V-application cannot be copied, moved or deleted.

To check all, press  **Options** ➔ **Select *Select All***

➔ Press 

To uncheck all, press  **Options** ➔ **Select *Unselect***

All ➔ Press 

Copying/Moving Files

Copy or move files to other folders in Data Folder.

- Copy/forward protected files cannot be copied.
- Default folders support corresponding file formats (see **P.8-2**).
- Some files may not be copied or moved.







Note ▶

- Disable write protection of SD Memory Card before copying or moving files to SD Memory Card.
- Files copied or moved to SD Memory Card may not be used on other Vodafone handsets, PCs and other devices.
- If a copy/forward protected file is included in the selected files, the protected file and the succeeding files are not copied.

Tip ▶ Name of copied or moved file may change when the same name already exists in the folder.

Copying/Moving Single Files

Main Menu ▶ *Data Folder* ➔ *Select a folder*

- 1** Select a file and press  **Options**
- 2** Select ***Advanced*** and press 
- 3** Select ***Copy*** or ***Move*** and press 
 - ▶ To copy or move to SD Memory Card Data Folder, press .
 - ▶ To copy or move to created sub folders, select a folder ➔ Press 
- 4** Press 

Copying/Moving Multiple Files

Files in V-appli, Bookmarks, My Saved Page and Text Templates folders can only be copied or moved one at a time.

Main Menu ▶ Data Folder ▶ *Select a folder* ▶ Options (⏏) ▶
Advanced ▶ Multiple Select

1 Select a file and press



- ✓ appears. To cancel, press  again.

2 Repeat Step 1

- To check or uncheck all files at once, see P.8-15.

3 Press Options

4 Select *Copy* or *Move* and press

- To copy or move to SD Memory Card Data Folder, press .
- To copy or move to created sub folders, select a folder ▶
Press 

5 Press

Connectivity

Getting Started

Exchange files and information between handset and other devices via Bluetooth or infrared. Use Bluetooth to connect to other handsfree devices or use handset as a modem.

Transfer Options

One File transfer	Transfer files/entries one by one. Received files/entries are saved to corresponding functions.
All File transfer	Transfer all files/entries by function
Receive folder	Receive a folder and its contents. Folders are saved to Data Folder. (802SH does not support sending folders.)

- Note** ▶
- During infrared transfers or Bluetooth transmissions, handset automatically enters Off Line Mode. Thus transfers are disabled while receiving calls/messages, during calls, while using Vodafone live! services or Media Player, while editing mail or data, etc. Off Line Mode is cancelled after transfers.
 - Some entries in Phone Book, Calendar, Tasks, Text Templates and Bookmarks may not be saved in whole or part.

Available Files

Function	One File	All Files	Note
Phone Book	Available	Available	In One File transfers, the following settings are lost: Group, Secret and Ringtone. All File transfer includes Owner Profile.
Calendar	Available	*1	In One File transfers, Secret mode settings are lost
Tasks	Available	*1	In One File transfers, Secret mode settings are lost
Text Templates	*2	Available	
Data Folder	Available	*3	Files or sub folders in DCIM folder and copy protected files cannot be transferred
Bookmarks	*2	Available	In One File transfers, received entries are saved to Other Documents folder as an unknown file

*1 In All File transfers, Calendar and Tasks are sent together from **Appointments/Tasks**.

*2 Only receiving files/entries is supported.

*3 Receive folders one by one via infrared.

- Tip** ▶
- Handset stores up to 300 entries between Calendar and Tasks. If the limit is reached during a transfer, the remaining entries will not be received.
 - Transfer files in SD Memory Card Data Folder one by one. Files in DCIM folder cannot be transferred.

Bluetooth

Getting Started

Bluetooth is a wireless technology that allows 802SH to communicate with other compatible devices (PCs, mobile phones, handsfree devices, etc.).

Precautions

Handset Bluetooth Specifications:

Communication system	Bluetooth specification Ver. 1.1
Bluetooth profiles supported	Headset Profile Hands-Free Profile Dial-up Networking Profile ObjectPush Profile
Output	Bluetooth Power Class 2

- Bluetooth connections are available with compatible devices supporting the same profile.
- Bring handsets to within 10 m. Bluetooth connection/transfer rate is affected by distance between handsets, obstructions, signal conditions, handset status, etc.
- Bluetooth operates in the 2.4 GHz unlicensed frequency band. Depending on the status of other devices used in the spectrum, Bluetooth connection may slow down/terminate, or the range may decrease.
- Connect handset to one device at a time via Bluetooth.

Bluetooth Connection

Activate Bluetooth (see P.9-4) on recipient device. Connection starts when a request is received from the other device. (Passcode may be required.)

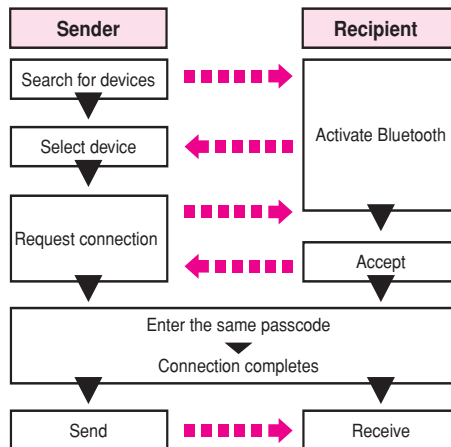

Passcodes are not necessary for paired devices.

Passcode

Passcodes (4 to 16 digits) are specific for Bluetooth connection. Pairing is possible when Passcodes of both devices match. Passcode is unset by default.

Bluetooth Indicators

⌘	Bluetooth transmission ready
⌘•	Bluetooth transmission in progress
⌘ ^o	Bluetooth talk in progress

Activating Bluetooth

Activate Bluetooth before receiving files/entries or connecting handset to handsfree devices. Bluetooth is **Off** by default.

Main Menu ► *Connectivity* ► *Bluetooth* ► *Switch On/Off*

1 Choose **On** and press ●

Standby returns (⌘).

- To cancel, choose **Off** ► Press ●
 - When transmission is in progress, press **Yes**.

Visibility

Allow other Bluetooth devices to find 802SH during device search.

- Set Visibility to **Hide My Phone** to hide 802SH from other Bluetooth devices.
- Visibility is set to **Show My Phone** by default.

Main Menu ► *Connectivity* ► *Bluetooth* ► *Visibility*

1 Select **Show My Phone** and press ●

- To stay invisible, select **Hide My Phone** ► Press ●

Device Search & Pairing

Search for Bluetooth devices for pairing.

- Passcodes are not necessary for paired devices.
- Search for up to 16 devices at a time.
- Activate Bluetooth on devices to be paired with.

Main Menu ► *Connectivity* ► *Bluetooth*

1 Select **Search for Devices** and press ●

Found devices are listed after search.

- When transmission is in progress, press **Yes**.
- Press **Cancel** to cancel.







2 Select a device and press ●

3 Enter the same passcode (4 to 16 digits) for handset and the other device and press ●







When pairing is complete, **Pairing is successful**. appears and Standby returns.

- Enter numbers (0 - 9) for passcodes.
- For handsfree devices, enter specified passcodes.
- Complete code entry within 30 seconds.

Device Indicator







	PC		Wireless headset
	PDA		Handsfree device
	Mobile phone		Others

Renaming Paired Devices

Press  → **Select Connectivity** → Press  → **Select Bluetooth** → Press  → **Select Paired Devices** → Press  → **Select a device** → Press  → **Enter a name** → Press 

- Enter up to 16 characters.

Deleting Paired Devices

Press  → **Select Connectivity** → Press  → **Select Bluetooth** → Press  → **Select Paired Devices** → Press  → **Select a device** → Press  → **Select Delete** → Press  → Press  → **Yes**

Pairing with Handsfree Devices

Start device search with handsfree devices for pairing.

Handset receives a connection request → Press  **Yes** → **Enter passcode** → Press 

- Activate Bluetooth on handset and set Visibility to **On** beforehand (see P.9-4).









Note → Pair with up to 32 devices. When full, device search is not available.

Bluetooth Operations

One File Transfer

Sending

Send one file or entry from Phone Book, Calendar, Tasks or Data Folder (see P.9-2).

- 1 Open file or entry list, select a file or entry and press  **Options****
- 2 Select *Send*, *Send Entry* or *Send My Card* and press **
- 3 Select *Via Bluetooth* and press **
 - When there is no entry in Paired Devices, device search starts.
 -  To send files/entries to unpaired devices, select **More Devices** → Press  → Device search starts
 -  When transmission is in progress, press  **Yes**.
- 4 Select a device and press **
- 5 Press  **Yes****
Off Line Mode is set.
- 6 Edit title and press **
 - Source file or entry name remains unchanged. To proceed without changing the title, press .

7 Prepare recipient device

8 Press **Yes**

Connecting... appears and transfer starts.



When requested, enter passcode → Press 

Receiving

Main Menu ► Connectivity ► Bluetooth ► Switch On/Off

1 Choose *On* and press

2 When connection is requested, *Calling not available during operation, OK?* appears

To accept connection request from unpaired devices, press  **Yes** → Enter passcode → Press  → Off Line Mode confirmation appears.

3 Press **Yes**

4 Enter Handset Code and press

Off Line Mode is set and transfer starts.

Press  **Back** to cancel.

Press  to end.

5 Confirmation appears when file or entry is received

6 Press **Yes**

To cancel transfer, press  **lto** → Press  **Yes**

Note ► Bluetooth connection may not be possible with some Bluetooth devices.

- Handset shall be connected to certified Bluetooth devices that meet the specification standards developed by Bluetooth SIG.
- Depending on characteristics or specifications of the certified Bluetooth devices, connection or data transfers may fail, or operational procedures, display content and actual operations may differ from those described in this manual.
- Noise may interfere with wireless or handsfree conversations depending on the status of connected devices or signal condition.
- For details about headset/handsfree devices, refer to specific device manuals.

All File Transfer

Sending

Main Menu ► Connectivity ► Bluetooth

1 Select **Send All** and press **OK**

- When there is no entry in Paired Devices, device search starts.
- To send files/entries to unpaired devices, select **More Devices** ► Press **OK** ► Device search starts
- When transmission is in progress, press **Yes**.

2 Select a device and press **OK**

3 Press **Yes**

Off Line Mode is set.

4 Enter Handset Code and press **OK**

5 Prepare recipient handset

6 Select an item and press **OK**

7 Press **Yes**

Connecting... appears and transfer starts.

- When requested, enter passcode ► Press **OK**
- **Picture data in Phone Book transfer?** appears for **Phone Book**. Press **Yes** or **No**.

Receiving

Main Menu ► Connectivity ► Bluetooth ► Switch On/Off

1 Choose **On** and press **OK**

2 When connection is requested, **Calling not available during operation, OK?** appears

- To accept connection request from unpaired devices, press **Yes** ► Enter passcode ► Press **OK** ► Off Line Mode confirmation appears.

3 Press **Yes**

Off Line Mode is set.

4 Enter Handset Code and press **OK**

5 Transfer starts and confirmation appears.

- Press **Cancel** to cancel.
- Press **End** to end.

6 To Add Entries

1 Select **As New Items** and press **OK**

When transfer completes, Standby returns.

- Press **Cancel** to cancel.
- Press **End** to end.

To Overwrite Existing Entries

1 Select **Delete All & Save** and press **OK**

2 Press **Yes**

When transfer completes, Standby returns.

- When Phone Book is overwritten, all Owner Profile contents are deleted, except handset phone number.
- Press **Cancel** to cancel.
- Press **End** to end.

Connecting Handsfree Devices

Pair with handsfree devices beforehand (see P.9-4).

Main Menu ▶ *Connectivity* ▶ *Bluetooth* ▶ *Handsfree Devices*

1 Select a device and press

The device is connected and (checked) appears.

When transmission is in progress, press **Yes**.

To disconnect, select a device ▶ Press .

To rename, select a device ▶ Press **Options** ▶ Select **Change Name** ▶ Press ▶ Enter a name ▶ Press .

To delete, select a device ▶ Press **Options** ▶ Select **Delete** ▶ Press ▶ Press **Yes**.

Connection Requested by Handsfree Devices

If paired with handset, devices are connected automatically.

To connect unpaired devices, press **Yes ▶**

Enter passcode ▶ Press .

Sound Output

Switch sound output between handset and handsfree devices.

During a call, press **Options ▶ Select **BT Headset****

▶ Press ▶ Choose *On* or *Off* ▶ Press .

- Choose **On** to use handsfree devices, and **Off** to use handset.

- Note** ▶
- During handsfree Voice Calls, adjust Earpiece Volume on handset.
 - When using handsfree devices, place calls in Standby.

Tip ▶ Devices marked with reconnect to handset when placing or receiving calls.

Bluetooth Settings

Device Name Specify a Bluetooth name for handset

Default 802SH

Main Menu ▶ *Connectivity* ▶ *Bluetooth* ▶ *Bluetooth Settings*
▶ *Device Name*

Enter a name ▶ Press

- Enter up to 16 characters. (Pictographs are not available.)

Bluetooth Timeout Set idle time before Bluetooth is deactivated

Default No Timeout

Main Menu ▶ *Connectivity* ▶ *Bluetooth* ▶ *Bluetooth Settings*
▶ *Bluetooth Timeout*

Select time ▶ Press

- To cancel, select **No Timeout** ▶ Press .

Handsfree Setting Select whether to talk handsfree when placing calls with handset

Default Handsfree mode

Main Menu ▶ *Connectivity* ▶ *Bluetooth* ▶ *Bluetooth Settings*
▶ *Handsfree Setting*

Select **Private mode** or **Handsfree mode** ▶ Press

- When placing calls with handsfree devices, only handsfree conversation is available regardless of the setting.

Infrared

Getting Started

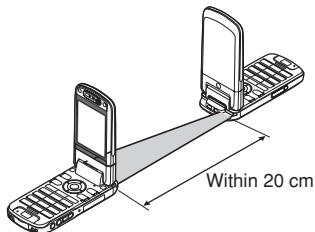

Precautions



- Bring handsets to within 20 cm and place the ports face-to-face. Do not place objects between handsets.
- Keep the ports face-to-face during transfer.
- Transfers may fail under direct sunlight or fluorescent lights, or near infrared equipment.
- Clean the ports with a soft cloth. Files may not transfer properly when ports are not clean.
- Infrared transfers are disabled whilst handset is connected to the Network (receiving/sending mail or information) or whilst using Vodafone live! services.
- 802SH complies with IrMC 1.1, but some files may not be exchanged.

Tip ▶ When transfer fails, **Device not found. Reconnect?** appears. Take the precautions on the left and press  **Yes** to try again.

Infrared Indicators

 (grey)	Infrared transmission ready
 (red)	Infrared connection in progress
	Infrared transmission in progress



Activating Infrared

Activate Infrared when transferring files.
Infrared is **Off** by default.

Main Menu ▶ *Connectivity* ▶ *Infrared* ▶ *Switch On/Off*

1 Choose **On** and press

Standby returns [ (grey)].

 To cancel, choose **Off** ▶ Press 

Authorisation Code







Authorisation codes (four digits) are specific for infrared transfers. Transfers are possible when Authorisation codes of both handsets match. Authorisation code is unset by default.

Transferring Files

One File Transfer

Sending







Send one file or entry from Phone Book, Calendar, Tasks or Data Folder (see P.9-2).

- 1** Open file or entry list, select a file or entry and press  **Options**
- 2** Select **Send**, **Send Entry** or **Send My Card** and press 
- 3** Select **Via Infrared** and press 
- 4** Press  **Yes**
Off Line Mode is set.
- 5** Edit title and press 
 - Source file or entry name remains unchanged. To proceed without changing the title, press .
- 6** Prepare recipient handset
- 7** Within 15 seconds, press  **Yes**
Transfer starts. When finished, file or entry list returns.

Receiving

Main Menu ► Connectivity ► Infrared ► Switch On/Off

- 1** Choose **On** and press 

Infrared is activated. appears and Standby returns. Acquire infrared transmission within five minutes.
- 2** When infrared transmission is acquired, **Calling not available during operation, OK?** appears
- 3** Press  **Yes**
Off Line Mode is set and transfer starts.
 Press  **Cancel** to cancel.
 Press  to end.
- 4** Confirmation appears when file or entry is received
- 5** Press  **Yes**
 To cancel transfer, press  **No** ► Press  **Yes**

All File Transfer

Handset Code and Authorisation code are required to transfer all files (see P.9-9).

Sending

Main Menu ► Connectivity ► Infrared

- 1 Select **Send All** and press ●
 - 2 Press .
Off Line Mode is set.
 - 3 Enter Handset Code and press ●
 - 4 Select an item and press ●
 - 5 Prepare recipient handset
 - 6 Enter Authorisation code and press ●
 - 7 Within 15 seconds, press .
- Transfer starts. When finished, Send All menu returns.
- Picture data in Phone Book transfer?** appears for Phone Book. Press or .

Receiving

Main Menu ► Connectivity ► Infrared ► Switch On/Off

- 1 Choose **On** and press ●
Infrared is activated. appears and Standby returns. Acquire infrared transmission within five minutes.
- 2 **Calling not available during operation, OK?** appears

- 3 Press .

Off Line Mode is set.

- 4 Enter Handset Code and press ●

- 5 Enter Authorisation code and press ●

• Enter the same Authorisation code as sender's.

- 6 When infrared transmission is acquired, **Calling not available during operation, OK?** appears

Press to cancel.

Press to end.

- 7 **To Add Entries**

- 1 Select **As New Items** and press ●

When transfer completes, Standby returns.

Press to cancel.

Press to end.

To Overwrite Existing Entries

- 1 Select **Delete All & Save** and press ●

- 2 Press .

When transfer completes, Standby returns.

• When Phone Book is overwritten, all Owner Profile contents are deleted, except handset phone number.

Press to cancel.

Press to end.

Receiving Folders

Receive folders from compatible handsets and save to handset Data Folder.

- 802SH does not support sending folders.
- 802SH receives folders when it can newly create a folder, or a folder with the same name already exists in the same layer as that of sender's.

Main Menu ► Connectivity ► Infrared ► Switch On/Off



1 Choose **On** and press

Infrared is activated. appears and Standby returns. Acquire infrared transmission within five minutes.

2 When infrared transmission is acquired, *Calling not available during operation, OK?* appears

3 Press **Yes**

Off Line Mode is set and transfer starts. When finished, Standby returns.

If a folder with the same name already exists, press  **Yes** or  **No**.

PC Transmissions

Features:

3G/GSM GPRS Modem	Use handset as a modem for packet data communication (see P.9-13)
Handset Manager	Exchange files between handset and PCs (see P.9-14)

Install 3G/GSM GPRS Modem and Handset Manager on your PC from the supplied Utility Software (see **P.9-13**).

System Requirements

System requirements for 3G/GSM GPRS Modem and Handset Manager:

Computer	<ul style="list-style-type: none"> • Personal computer with a CD-ROM drive • Bluetooth port, infrared port¹ or USB port
Operating System	Windows 98 SE, Me, 2000 or XP ²
CPU	Pentium 266 MHz or faster processor
Memory	64 MB or more (256 MB or more recommended)

¹Not supported by 3G/GSM GPRS Modem

²Service Pack 1a

3G/GSM GPRS Modem and Handset Manager are not compatible with Mac OS.

Utility Software

Install 3G/GSM GPRS Modem and Handset Manager on your PC from the supplied Utility Software CD-ROM.

1 Insert Utility Software to CD-ROM drive

Utility Software programme opens automatically.

- If the programme does not open automatically, use Windows Explorer or My Computer to browse to the CD-ROM drive and double-click on **Launcher.exe**.

2 Click on the software to install

- Follow onscreen instructions.

3G/GSM GPRS Modem

Connect handset to PC via Bluetooth or USB to transmit packet data.

- Install 3G/GSM GPRS Modem on your PC from the supplied Utility Software CD-ROM.
- 3G/GSM GPRS Modem does not support infrared transmissions.
- For network settings on your PC, refer to the information provided by your Internet Service Provider or the instruction manual of your PC.

■ Bluetooth Wireless Connection

Activate handset Bluetooth connectivity (see **P.9-4**).

■ USB Cable Connection

Install the USB driver on your PC from the supplied Utility Software CD-ROM. Connect handset to PC via optional USB cable II (refer to the installation guide supplied with the USB cable).

- Note** ►
- Use handset as a modem only when signal conditions are stable.
 - 3G/GSM GPRS Modem and Handset Manager cannot be used simultaneously.
 - Disconnect USB cable from PC when not in use, to save battery power on your PC.

- Tip** ► Use Desktop Holder to charge handset during data transmissions.

Handset Manager

Exchange files and information between handset and PC via Bluetooth, infrared or USB.

Compatible files and information:

Data Folder Files	Files in Pictures, Videos, Sounds & Ringtones and Other Documents folders
Phone Book	Phone Book entries
Calendar	Schedule entries

Install Handset Manager on your PC from the supplied Utility Software CD-ROM (see **P.9-13**).

Bluetooth or Infrared Wireless Connection

Activate handset Bluetooth or infrared connectivity (see **P.9-4, P.9-9**), then use Handset Manager on your PC to establish connection and transfer files/information.

USB Cable Connection

Install the USB driver on your PC from the supplied Utility Software CD-ROM. Connect handset to PC via optional USB cable II (refer to the installation guide supplied with the USB cable), then use Handset Manager on your PC to transfer files and information.

Note ▶ If you have troubles with transmissions between handset and Handset Manager, refer to the information on Handset Manager in "Troubleshooting" on **P.16-6**.

Network Settings

See indicated pages for the following items:

System Settings	See P.2-14	Select Network	See P.2-14
Off Line Mode	See P.2-18		

During setting operation, press  **Back** to return to the previous window.

Add, Edit & Delete



Add, edit or delete Networks

Main Menu

▶ *Connectivity* ▶ *Network Settings* ▶ *Network Settings* ▶ *Select Network* ▶ *Add New Network*

Adding Network

Select Add ▶ **Press**  ▶ **Enter a country code** ▶ **Press**  ▶ **Enter a Network code** ▶ **Press**  ▶ **Enter name** ▶ **Press**  ▶ **Select *Select network type*** ▶ **Press**  ▶ **Select a Network type** ▶ **Press** 

- Add up to 5 Networks.
- After selecting **Add New Network** and pressing , Network list appears if Network has already been added. In this case, press  again and perform above operations.
- Use up to 3 digits for country code and Network code, and up to 25 single-byte alphanumeric for name.

Editing Network

Select a Network ▶ **Press**  ▶ **Select *Change*** ▶ **Press**  ▶ **Edit settings**

- Edit in the same way as in Adding Network.

Deleting Network

Select a Network ▶ **Press**  ▶ **Select *Delete*** ▶ **Press** 

Set Preferred

Set priority of Networks to be selected when **Auto** is set in Select Network (see **P.2-14**)

Main Menu

► *Connectivity* ► *Network Settings* ► *Network Settings* ► *Select Network* ► *Set Preferred*

Inserting Network

Select a place to insert ► Press ● ► Select *Insert*
► Press ● ► Select a Network ► Press ●

- Network is inserted above the selected entry.

Adding Network to the End

Press ● ► Select *Add to end* ► Press ● ► Select a Network ► Press ●

Deleting Network

Select a Network ► Press ● ► Select *Delete* ► Press ●

Network Information

Check Network Information

Main Menu

► *Connectivity* ► *Network Settings* ► *Network Settings*

Select *Network Information* ► Press ●

Internet Setting

Use default settings. Change settings when specific Proxy/ Access Point settings are required.

Profile Contents**Application**

See **P.9-17** for details.

Web Settings

Setting	Note
Profile Name	Up to 60 single-byte alphanumerics
Proxy	Select from the list

MMS Settings

Setting	Note
Profile Name	Up to 60 single-byte alphanumerics
Proxy	Select from the list
Relay Server URL	Up to 128 single-byte characters

Streaming Settings

Setting	Note
Profile Name	Up to 60 single-byte alphanumerics
Proxy Address	Up to 64 digits
Proxy Port Number	1 - 65535
Access Point	Select from the list

Proxy

See **P.9-18** for details.

Setting	Note
Proxy Name	Up to 60 single-byte alphanumerics
Proxy Address	Up to 64 digits
Access Point	Select from the list
Home	Up to 128 single-byte characters
Port Number	1 - 65535
Authentication Type	HTTP-BASIC or HTTP-DIGEST
User Name	Up to 16 single-byte characters
Password	Up to 16 single-byte characters

Access Point

See **P.9-18** for details.

Setting	Note
Access Point Name	Up to 60 single-byte alphanumerics
APN	Up to 64 digits
Authentication Type	NONE, PAP or CHAP
User Name	Up to 32 single-byte characters
Password	Up to 16 single-byte characters
DNS	Up to 15 digits
Linger Time	1 - 99999 seconds

Settings

Application

See P.9-15 for each setting item.

Create New

Create new Profiles for Web, MMS or Streaming connections

Main Menu ▶ Connectivity ▶ Internet Setting ▶ Application

Select **Web Settings, MMS Settings or Streaming Settings** ▶ Press ● ▶ Select **Create New** ▶ Press ● ▶ Select an item (see P.9-15) ▶ Press ● ▶ Enter or select item ▶ Press ● ▶ Press ▾ **Options** ▶ Select **Set** ▶ Press ●

Activate

Select Profiles to be used for Web, MMS or Streaming connections

Main Menu ▶ Connectivity ▶ Internet Setting ▶ Application

Select **Web Settings, MMS Settings or Streaming Settings** ▶ Press ● ▶ Select a Profile ▶ Press ●

Edit

Edit Profiles

Main Menu ▶ Connectivity ▶ Internet Setting ▶ Application

Select **Web Settings, MMS Settings or Streaming Settings** ▶ Press ● ▶ Select a Profile ▶ Press ▾ **Options** ▶ Select **Edit** ▶ Press ● ▶ Select an item (see P.9-15) ▶ Press ● ▶ Edit item ▶ Press ● ▶ Press ▾ **Options** ▶ Select **Set** ▶ Press ● ▶ Press ▾ **Yes**

Copy

Copy Profiles

Main Menu ▶ Connectivity ▶ Internet Setting ▶ Application

Select **Web Settings, MMS Settings or Streaming Settings** ▶ Press ● ▶ Select a Profile ▶ Press ▾ **Options** ▶ Select **Copy** ▶ Press ● ▶ Enter Profile Name (see P.9-15) ▶ Press ●

Delete

Delete Profiles

Main Menu ▶ Connectivity ▶ Internet Setting ▶ Application

Select **Web Settings, MMS Settings or Streaming Settings** ▶ Press ● ▶ Select a Profile ▶ Press ▾ **Options** ▶ Select **Delete** ▶ Press ● ▶ Press ▾ **Yes**

Proxy & Access Point

See P.9-16 for each setting item.

Create New Create new Proxy and Access Point

Main Menu ▶ *Connectivity* ▶ *Internet Setting*

Select *Proxy* or *Access Point* ▶ Press **⊙** ▶ Select *Create New* ▶ Press **⊙** ▶ Select an item (see P.9-16) ▶ Press **⊙** ▶ Enter or select item ▶ Press **⊙** ▶ Press **⏏** **Options** ▶ Select *Set* ▶ Press **⊙**

Edit Edit Proxy and Access Point

Main Menu ▶ *Connectivity* ▶ *Internet Setting*

Select *Proxy* or *Access Point* ▶ Press **⊙** ▶ Select a Proxy/Access Point ▶ Press **⊙** ▶ Select an item (see P.9-16) ▶ Press **⊙** ▶ Edit item ▶ Press **⊙** ▶ Press **⏏** **Options** ▶ Select *Set* ▶ Press **⊙** ▶ Press **⏏** **Yes**

Copy Copy Proxy and Access Point

Main Menu ▶ *Connectivity* ▶ *Internet Setting*

Select *Proxy* or *Access Point* ▶ Press **⊙** ▶ Select a Proxy/Access Point ▶ Press **⏏** **Options** ▶ Select *Copy* ▶ Press **⊙** ▶ Enter name (see P.9-16) ▶ Press **⊙**

Delete Delete Proxy and Access Point

Main Menu ▶ *Connectivity* ▶ *Internet Setting*

Select *Proxy* or *Access Point* ▶ Press **⊙** ▶ Select a Proxy/Access Point ▶ Press **⏏** **Options** ▶ Select *Delete* ▶ Press **⊙** ▶ Press **⏏** **Yes**

Additional Settings

Re-Provisioning When Profiles are changed, perform Retrieve NW Info and update the settings

Main Menu ▶ *Connectivity* ▶ *Internet Setting* ▶ *Re-Provisioning*

Retrieving Network Information

Select *Retrieve NW Info* ▶ Press **⊙** ▶ Press **⏏** **Yes**

Updating

Select *Execute Pending* ▶ Press **⊙** ▶ Select an item ▶ Press **⊙** twice ▶ Enter Handset Code ▶ Press **⊙**

Clear DNS Cache Clear Vodafone live! Sever addresses stored on handset

Main Menu ▶ *Connectivity* ▶ *Internet Setting*

Select *Clear DNS Cache* ▶ Press **⊙**

White List Create/Delete White List

Main Menu ▶ *Connectivity* ▶ *Internet Setting* ▶ *White List*

Creating White List

By changing, you might not be able to take any push service. appears ▶ Press **⏏** **Yes** ▶ Enter Handset Code ▶ Press **⊙** twice ▶ Select *Create New* ▶ Press **⊙** ▶ Select *SMSC Address* or *SM Orig. Address* ▶ Press **⊙** ▶ Enter address ▶ Press **⊙** ▶ Press **⏏** **Options** ▶ Select *Set* ▶ Press **⊙**

- Enter up to 18 digits for SMSC Address or SM Orig. Address.

Deleting White List

By changing, you might not be able to take any push service. appears ▶ Press **⏏** **Yes** ▶ Enter Handset Code ▶ Press **⊙** twice ▶ Select a number ▶ Press **⏏** **Options** ▶ Select *Delete* ▶ Press **⊙** ▶ Press **⏏** **Yes**

Backup & Restore

Back-up entries to SD Memory Card by function, and restore to handset whenever necessary.

Precautions

All files of the following functions can be transferred at once:

- Phone Book
- Calendar
- Tasks
- Text Templates
- Bookmarks

All contents are copied to SD Memory Card as a single file.
(File name is the date of transfer.)

Backup file contents can only be accessed when restored to handset.

- Backup or Restore is not available when the battery is low.
- When a V-application is paused, **Application is currently suspended. End application?** appears. Press  **Yes** to start Backup.
- When SD Memory Card memory is low, files may not transfer correctly.
- Some items may not be transferable. Some backup files may not be used on other Vodafone handsets, PCs and other devices.

- Handset stores up to 300 entries between Calendar and Tasks. If the limit is reached during a transfer, the remaining entries will not be received.
- Backup or Restore is useful to back-up files (for a newly purchased handset) or exchange files with SD Memory Card compatible handsets.

Handset to Memory Card

Read "Precautions" on P.9-19 beforehand.

Main Menu ► Connectivity ► Backup/Restore ► Backup





1 Enter Handset Code and press

2 Press

Off Line Mode is set.

 When handset is connected to the Network, press .

3 Select an item and press

 *Save phone book pictures as well?* appears for *Select All* or *Phone Book*. Press   or  .

 To cancel, press  .

Memory Card to Handset

- Handset data is overwritten after restoring.
- Read "Precautions" on P.9-19 beforehand.

Main Menu ► Connectivity ► Backup/Restore ► Restore

1 Enter Handset Code and press

2 Press

Off Line Mode is set.

 When handset is connected to the Network, press .

3 Select an item and press



- Some items may not be selected.

4 Select a file and press

- If there is more than one file, use transfer date to select.

Example: 041215XX indicates the file was transferred on 15 December 2004. (XX: 00 - 99 or aa - zz)

- For *Select All*, repeat Step 4 for each item.

 To delete files on SD Memory Card, select one ► Press 
 ► Select *Delete* ► Press  ► Press  

5 Press

 To cancel, press  .

Additional Functions

Mode Settings

Activate Normal, Meeting, Activity, Car, Headset or Manner mode to switch handset settings automatically. Most suitable handset responses for each mode are set by default.

Mode Settings Select from six modes

Default Normal

Main Menu ▶ Settings ▶ Mode Settings

Select a mode ▶ Press ●

Set to Default Reset Mode Settings

Main Menu ▶ Settings ▶ Mode Settings

Select a mode ▶ Press ▾ Options ▶ Select **Set to Default** ▶ Press ● ▶ Enter Handset Code ▶ Press ● ▶ Press ▾ Yes

Customising Incoming Communication Settings

Volume Set Ringtone volume

Default Normal/Headset: Level:3, Activity: Level:5, Meeting/ Car/ Manner: Silent

Main Menu ▶ Settings ▶ Mode Settings

Select a mode ▶ Press ▾ Options ▶ Select **Personalise** ▶ Press ● ▶ Select **Volume** ▶ Press ● ▶ Select a level ▶ Press ●

- **Level:5** is maximum. When **Increasing Volume** is set, volume increases in the order of Level:1 - Level:5 every three seconds.

Ringtone/ Ringvideo Set Ringtones or Ringvideos for Voice Calls, TV Calls and New Messages

Main Menu ▶ Settings ▶ Mode Settings

Ringtone

Select a mode ▶ Press ▾ Options ▶ Select **Personalise** ▶ Press ● ▶ Select **Ringtone/Ringvideos** ▶ Press ● ▶ Select a mode ▶ Press ● ▶ Select **Assign Tone** ▶ Press ● ▶ Select **Preset Sounds or My Sounds** ▶ Press ● ▶ Select sound ▶ Press ▾ Options ▶ Select **Assign** ▶ Press ●

▶ To play sound files, press ▾ Options ▶ Select **Play** ▶ Press ●

Ringvideo

Select a mode ▶ Press ▾ Options ▶ Select **Personalise** ▶ Press ● ▶ Select **Ringtone/Ringvideos** ▶ Press ● ▶ Select a mode ▶ Press ● ▶ Select **Assign Video** ▶ Press ● ▶ Select video ▶ Press ●

Duration (New Message)

Select a mode ▶ Press ▾ Options ▶ Select **Personalise** ▶ Press ● ▶ Select **Ringtone/Ringvideos** ▶ Press ● ▶ Select **For New Message** ▶ Press ● ▶ Select **Duration** ▶ Press ● ▶ Enter time (01 - 15) ▶ Press ●

- Tip** ▶
- V-application set as Screensaver that also responds to incoming communications may take priority over.
 - New Message includes incoming Web information.

Vibration

Handset vibrates for incoming communications

Default Meeting/Activity/Headset/Manner: On, Normal/Car: Off

Main Menu ▶ Settings ▶ Mode Settings

Select a mode ▶ Press **Options** ▶ Select *Personalise* ▶ Press **Options** ▶ Select *Vibration* ▶ Press **Options** ▶ Choose *On, Off or Link to Sound* ▶ Press **Options**

- **Link to Sound:** Handset vibrates only when Ringtone is a compatible SMAF file.

Note ▶ Disable vibration when charging.

External Light

Change Mobile Light colour

Default Green

Main Menu ▶ Settings ▶ Mode Settings

Select a mode ▶ Press **Options** ▶ Select *Personalise* ▶ Press **Options** ▶ Select *External Light* ▶ Press **Options** ▶ Select a mode ▶ Press **Options** ▶ Select a colour ▶ Press **Options**

- To disable External Light, choose *Off* ▶ Press **Options**

Any Key Answer

Activate or deactivate Any Key Answer (see P.2-5)

Default Normal/Meeting/Activity/Manner: Off, Car/Headset: On

Main Menu ▶ Settings ▶ Mode Settings

Select a mode ▶ Press **Options** ▶ Select *Personalise* ▶ Press **Options** ▶ Select *Any Key Answer* ▶ Press **Options** ▶ Choose *On or Off* ▶ Press **Options**

Customising System Sounds

Keypad Tones

A tone sounds when a key is pressed

Default Touch Tone

Main Menu ▶ Settings ▶ Mode Settings

Select a mode ▶ Press **Options** ▶ Select *Personalise* ▶ Press **Options** ▶ Select *System Sounds* ▶ Press **Options** ▶ Select *Keypad Tones* ▶ Press **Options** ▶ Select a pattern ▶ Press **Options**

- To assign *Pattern 1, Pattern 2* or *Pattern 3*, select pattern and press **Options** ▶ Select *Assign* ▶ Press **Options**
- To check patterns, press **Options**.
- To mute, choose *Off* ▶ Press **Options**

Warning Tone & Power On/Off Sound

A tone sounds for error (Warning Tone) or when turning power on/off

Default Warning Tone: Sound Effect 6 (0.5 seconds)
Power On Sound/Power Off Sound: Sound Effect 8 (03 seconds)

Main Menu ▶ Settings ▶ Mode Settings

Sound Pattern

Select a mode ▶ Press **Options** ▶ Select *Personalise* ▶ Press **Options** ▶ Select *System Sounds* ▶ Press **Options** ▶ Select *Warning Tone, Power On Sound or Power Off Sound* ▶ Press **Options** ▶ Select *Tone/Sound* ▶ Press **Options** ▶ Select *Preset Sounds or My Sounds* ▶ Press **Options** ▶ Select sound ▶ Press **Options** ▶ Select *Assign* ▶ Press **Options**

- To check patterns, press **Options** ▶ Select *Play* ▶ Press **Options**
- To mute, choose *Off* ▶ Press **Options**

Duration

Select a mode ▶ Press **Options** ▶ Select *Personalise* ▶ Press **Options** ▶ Select *System Sounds* ▶ Press **Options** ▶ Select *Warning Tone, Power On Sound or Power Off Sound* ▶ Press **Options** ▶ Select *Duration* ▶ Press **Options** ▶ Select or enter duration ▶ Press **Options**

Display

Display Settings

Wallpaper Use Wallpaper to show an image in Standby

Default: Windsurfer

Main Menu ▶ Settings ▶ Display Settings ▶ Wallpaper

Select **Preset Pictures, My Pictures or Other Documents** ▶ Press  ▶ Select an image ▶ Press  twice

■ To cancel, select **Blank** ▶ Press 

- Select **My Pictures** or **Other Documents** to use images in Data Folder (Pictures or Other Documents). When the current Wallpaper is an image in Data Folder, the image appears. Press  **Change** to select another image.

- Tip** ▶
- When a V-application is set as Screensaver, Wallpaper may not appear.
 - Using Wallpaper shortens Battery Time.

System Graphics Use images for Power On/Off, incoming calls and Alarm windows

Default: Power On/Power Off: Preset Animation, Alarm/Incoming Call: Pattern 1



Main Menu ▶ Settings ▶ Display Settings ▶ System Graphics





Power On/Power Off

Select **Power On** or **Power Off** ▶ Press  ▶ Select **Preset Animation, My Pictures or Other Documents** ▶ Press 

- For **My Pictures** and **Other Documents**, select an image ▶ Press  twice

Alarm/Incoming Calls

Select **Alarm** or **Incoming Call** ▶ Press  ▶ Select from **Pattern 1** to **Pattern 3, My Pictures or Other Documents** ▶ Press  twice

- For **My Pictures** and **Other Documents**, select an image ▶ Press  twice
- Select **My Pictures** or **Other Documents** to use images in Data Folder (Pictures or Other Documents). When the current Wallpaper is an image in Data Folder, the image appears. Press  **Change** to select another image. When the image is too large, a rectangle appears. Use  to specify display area and press .

- Note** ▶
- Ringtone and Ringvideo images for Mode Settings take priority over System Graphics for incoming calls.
 - Ringtone, Ringvideo and Picture images for Phone Book entries take priority over System Graphics for incoming calls with caller ID.

Clock & Calendar

Show or hide Clock/Calendar in Standby

Default: Clock: Large, Calendar: Off

Main Menu ▶ Settings ▶ Display Settings ▶ Clock & Calendar

Show Clock

Select **Show Clock** ▶ Press **⊙** ▶ Select **Large, Small, World Clock** or **Off** ▶ Press **⊙**

Calendar

Select **Calendar** ▶ Press **⊙** ▶ Select **1 month, 2 months** or **Off** ▶ Press **⊙**

Calendar Contents



Current Date

- Highlighted

Scheduled Date

- Underlined (see P.11-2 "Calendar" for schedules)

- Tip ▶
- Calendar appears on Wallpaper.
 - When a V-application is set as Screensaver, Calendar may not appear.

Font Settings

Change the weight of handset fonts

Default: Normal

Main Menu ▶ Settings ▶ Display Settings ▶ Font Settings

Select a weight ▶ Press **⊙**

Greeting Message

Create a short text message to appear on Display each time handset power is activated

Default: Off

Main Menu ▶ Settings ▶ Display Settings ▶ Greeting Message

Switch On/Off

Select **Switch On/Off** ▶ Press **⊙** ▶ Choose **On** or **Off** ▶ Press **⊙**

Edit Message

Select **Edit Message** ▶ Press **⊙** ▶ Enter a message ▶ Press **⊙**

- Enter up to 10 characters.

Show Operator Name

Show or hide the name of your service provider in Standby

Default: Off

Main Menu ▶ Settings ▶ Display Settings ▶ Show Operator Name

Choose **On** or **Off** ▶ Press **⊙**

Language

Switch handset user interface between Japanese and English

Default: Automatic

Main Menu ▶ Settings ▶ 言語選択

Select **Automatic, 日本語** or **English** ▶ Press **⊙**

- When **Automatic** is set, mode changes according to System Settings (see P.2-14).

Light Settings

Backlight

Select Backlight illumination time

Default 15 seconds

Main Menu ► Settings ► Display Settings ► Backlight

Select time ► Press ●

■ To deactivate, choose **Off** ► Press ●

Brightness

Select Display Brightness from four levels

Default Level:2

Main Menu ► Settings ► Display Settings ► Brightness

Press ● (Light) or ● (Dark) ► Press ●

Display Saving

Select a period of inactivity after which Display shuts down

Default 2 minutes

Main Menu ► Settings ► Display Settings ► Display Saving

Select a period ► Press ●

Sound Settings

See indicated pages for the following items:

Volume	See P.10-2	Vibration	See P.10-3
Ringtone/ Ringvideo	See P.10-2	External Light	See P.10-3
System Sounds	See P.10-3		

Clock Settings

Set Date/Time

Set the date and time (the day of the week is set automatically)

Main Menu ▶ Settings ▶ Time & Date ▶ Set Date/Time

Enter the year ▶ Enter the month ▶ Enter the day ▶
Press ▶ Enter the time (24-hour format) ▶ Press

Note ▶ When removing the battery for replacement, etc., Clock settings remain. However, should the handset go without power for an extended period of time (approximately one week), Clock will need to be reset.

Tip ▶

- When Clock has not been set, --/-- --:-- appears for date and time.
- To correct numbers, use to move cursor and re-enter digits.
- Choose a Clock type or use Calendar for Standby (see P.10-5).

Time/Date Format

Change date/time format

Default Time Format: 24 Hour, Date Format: Y/M/D

Main Menu ▶ Settings ▶ Time & Date

Time Format

Select **Time Format** ▶ Press ▶ Select **24 Hour or 12 Hour** ▶ Press

Date Format

Select **Date Format** ▶ Press ▶ Select **D.M.Y, M-D-Y or Y/M/D** ▶ Press

Time Zone/ Daylight Saving

Change Time Zone or activate Daylight Saving

Default Time Zone: Tokyo, Daylight Saving: Off

Main Menu ▶ Settings ▶ Time & Date

Time Zone

Select **Set Time Zone** ▶ Press ▶ Use to select a Time Zone ▶ Press

■ If your zone is not preset, press **Options** ▶ Select **Set Custom Zone** ▶ Press ▶ Enter city name ▶ Press ▶ Enter time difference ▶ Press

Daylight Saving

Select **Daylight Saving** ▶ Press ▶ Choose **On or Off** ▶ Press

• Activate Daylight Saving to advance the selected area's time by one hour.

Calendar Format

Select whether to start the week on Sunday or Monday

Default Sunday-Saturday

Main Menu ▶ Settings ▶ Time & Date ▶ Calendar Format

Select **Sunday-Saturday or Monday-Sunday** ▶ Press

User Dictionary

Entries (Partly Japanese Only)

Save up to 100 frequently used words/phrases. Assign a reading (keyword) in hiragana to each entry. In text entry windows, enter a reading and convert. Saved words/phrases appear among word suggestions. Save up to five words/phrases per reading.

New Entry Save words/phrases to User Dictionary

Main Menu ▶ Settings ▶ User Dictionary ▶ New Entry

Enter a word/phrase ▶ Press ● ▶ Enter a reading (keyword) ▶ Press ●

- Enter up to 15 characters per word/phrase and eight characters in hiragana per reading.

Edit/Delete Edit or delete entries

Main Menu ▶ Settings ▶ User Dictionary ▶ Edit Dictionary ▶
Select a word

Edit

Press ▾ Options ▶ Select **Edit** ▶ Press ● ▶ Edit the word/phrase ▶ Press ● ▶ Edit reading ▶ Press ● ▶ Press ▾ Yes

Delete

Press ▾ Options ▶ Select **Delete** ▶ Press ● ▶ Press ▾ Yes

802SH Download Dictionary (Japanese Only)

Download specialised 802SH Download Dictionaries from Sharp's **Space Town** Mobile Internet site. Activate up to two dictionaries at one time to improve handset character conversion. Dictionary words appear among word suggestions. For details, access Sharp's **Space Town** Mobile Internet site (see P.13-11).

Acquire Dictionary Activate downloaded dictionary

Main Menu ▶ Settings ▶ User Dictionary ▶ Acquire Dictionary

Select a number ▶ Press ● ▶ Select a dictionary ▶ Press ●

To replace current dictionary, press ▾ Options ▶ Select **Change** ▶ Press ● ▶ Select a dictionary ▶ Press ●

Cancel Cancel dictionary

Main Menu ▶ Settings ▶ User Dictionary ▶ Acquire Dictionary

Select a number ▶ Press ▾ Options ▶ Select **Cancel** ▶ Press ●

Call Settings

See indicated pages for the following items:

Diverts	See P.12-2, P.12-4	Show Your Number	See P.12-10
Call Waiting	See P.12-5	Call Barring	See P.12-7

International Call

Int'l Prefix Save frequently used international prefix

Default:0046010

Main Menu ▶ Settings ▶ Call Settings ▶ Int'l Calling

Select **Int'l Prefix** ▶ Press ● ▶ Enter a prefix ▶ Press ●

Country Codes Change, add or delete Country Codes

Main Menu ▶ Settings ▶ Call Settings ▶ Int'l Calling ▶ Country Codes

Change

Select a country ▶ Press ● ▶ Select **Change** ▶ Press ● ▶ Enter a country name ▶ Press ● ▶ Enter country code ▶ Press ●

Add

Select a blank entry ▶ Press ● ▶ Enter a country name ▶ Press ● ▶ Enter country code ▶ Press ●

Delete

Select **Delete** ▶ Press ● ▶ Press  **Yes**

Additional Settings

Display Call Info Show or hide Call Cost and Call Time after each call

Default:On

Main Menu ▶ Settings ▶ Call Settings ▶ Display Call Info

Choose **On or Off** ▶ Press ●

Minute Minder Remind with a beep every one minute during a call

Default:Off

Main Menu ▶ Settings ▶ Call Settings ▶ Minute Minder

Choose **On or Off** ▶ Press ●

Display Call Timer Show or hide elapsed Call Time during a call

Default:On

Main Menu ▶ Settings ▶ Call Settings ▶ Display Call Timer

Choose **On or Off** ▶ Press ●

Handset Security

PIN

For more information on PIN, see P.1-7.

Activate Initial PIN Entry

Switch On/Off Select whether to require PIN every time handset is turned on (with USIM Card inserted)

Default: Off

Main Menu ► Settings ► Security ► PIN Entry ► Switch On/Off

Choose *On* or *Off* ► Press ● ► Enter PIN1 ► Press ●

PIN Lock

PIN1 Lock or PIN2 Lock is activated if PIN1 or PIN2 is incorrectly entered three times consecutively. To cancel PIN1 Lock or PIN2 Lock, follow these steps.

Open a function requiring PIN1 or PIN2 ► Enter Personal Unblocking Key (PUK Code) ► Press ● ► Enter new PIN1 or PIN2 ► Press ● ► Re-enter PIN1 or PIN2 ► Press ●

- For information on Personal Unblocking Key (PUK Code), contact Vodafone Customer Centre, General Information (see P.16-32).
- If PUK Code is incorrectly entered ten times, USIM Card is locked. (Count continues even if handset power is turned off.)
- For procedures required to unlock USIM Card, contact Vodafone Customer Centre, General Information (see P.16-32).

Changing PIN1 or PIN2

Change PIN Change PIN1 or PIN2

■ Activate Initial PIN Entry first.

Main Menu ► Settings ► Security

PIN1

Select *PIN Entry* ► Press ● ► Select *Change PIN* ► Press ● ► Enter current PIN1 ► Press ● ► Enter new PIN1 ► Press ● ► Re-enter new PIN1 ► Press ●

PIN2

Select *Change PIN2* ► Press ● ► Enter current PIN2 ► Press ● ► Enter new PIN2 ► Press ● ► Re-enter new PIN2 ► Press ●

Handset Locks

Phone Lock

Restrict access to handset functions

Default Off

Main Menu ▶ Settings ▶ Security ▶ Phone Lock

Enter Handset Code ▶ Press ●

■ To unlock, enter Handset Code in Standby or during a call
▶ Press ●

- Phone Lock remains active even if handset power is deactivated, then reactivated.

When Phone Lock is Active

- In Standby, press for 2+ seconds to deactivate handset power, for 1+ seconds to activate/cancel Keypad Lock, - to enter Handset Code or to edit Handset Code entry.
- Emergency calls to Police (110), Fire (119) and Coast Guard (118) are possible.
- During a call, press to end the call, or to show or hide Options, to mute Microphone, to switch between callers in Call Waiting or - to enter Handset Code or to edit Handset Code entry.
- Answer calls by pressing or keys for Any Key Answer (see P.2-5), or reject calls by pressing . Press to forward incoming calls (when When Busy is **On**).

Handset Lock

Activate Handset Lock to require Handset Code each time handset power is turned on

Default Off

Main Menu ▶ Settings ▶ Security ▶ Handset Lock

Choose **On or Off** ▶ Press ● ▶ Enter Handset Code
▶ Press ●

Phone Book Lock

Protect Phone Book entries from accidental alteration and restrict access to Phone Book information

Default Off

Main Menu ▶ Settings ▶ Security ▶ Phone Book Lock

Choose **On or Off** ▶ Press ● ▶ Enter Handset Code
▶ Press ●

- Note** ▶ When Phone Book Lock is active, the following Phone Book operations are disabled:
- Searching, saving, editing and dialling, including Speed Dial (see P.4-10).
 - Creating QR Codes from Phone Book entries or Owner Profile (see P.11-14).

Secret Mode

Activate Secret mode to open Secret mode entries.

Show
Secret Data

Activate or cancel Secret mode

Default Off

Main Menu ► Settings ► Security ► Show Secret Data

Choose **On** ► Press ● ► Enter Handset Code ►
Press ●

■ To exit Secret mode, choose **Off** ► Press ●

Note ► Do not save confidential information in Phone Book. Handset Code and thus Secret mode entries may be compromised.

When Secret Mode is Off

Phone Book Names/Picture images do not appear for incoming calls/mail from numbers/addresses in Secret mode entries. Personal Ringtones/Ringvideos are disabled. Names for numbers in Secret mode entries do not appear in Dialed Numbers, Received Calls or list of received messages. Names saved in Dialed Numbers or Received Calls before an entry is converted to a Secret mode entry appear even if handset is not in Secret mode.

Changing Handset Code

Change
Handset Code

Whenever necessary, change Handset Code

Default 9999

Main Menu ► Settings ► Security ► Change Handset Code

Enter current Handset Code ► Press ● ► Enter
new Handset Code ► Press ● ► Re-enter new
Handset Code ► Press ●

Memory Settings

Memory Status Check handset or SD Memory Card memory status

Main Menu ► Settings ► Memory Settings ► Memory Status

Select **Handset or Memory Card** ► Press ●

Tip ► A portion of SD Memory Card memory is reserved for storing copyright information, etc.

Example: 64 MB SD Memory Card

Approximately 60.6 MB is available for use.

Format Card Format SD Memory Card

Main Menu ► Settings ► Memory Settings ► Format Card

Enter Handset Code ► Press ● ► Press ⏪ **Yes**

- Note** ►
- When using a new SD Memory Card, format it for use with 802SH before trying to save files, etc.
 - Before formatting an SD Memory Card, make sure there is no important information saved on the card. Format Card deletes all files from SD Memory Card.
 - Never remove SD Memory Card or battery while formatting.
 - An improperly formatted SD Memory Card may not function as it should with 802SH.

LBS (Location Based Service) Settings

LBS URL Setting Use when accessing to a special URL

Main Menu ► Settings ► LBS Settings ► LBS URL Setting

Select **URL** ► Press ●

Datum On/Off Choose whether or not to send your location info automatically upon request

Default On

Main Menu ► Settings ► LBS Settings ► Datum On/Off

Choose **On or Off** ► Press ● ► Enter Handset Code ► Press ●

Reset

Reset Settings

Cancel custom settings and return handset functions to their default settings

Main Menu

▶ Settings ▶ Master Reset ▶ Reset Settings

Enter Handset Code ▶ Press ● ▶ Press ⏏ Yes

▶ Press ●

- Phone Book entries are unaffected.

Reset All

Clear all Phone Book entries, files in Data Folder, etc.

Main Menu

▶ Settings ▶ Master Reset ▶ Reset All

Enter Handset Code ▶ Press ● ▶ Press ⏏ Yes

▶ Press ●

Note ▶ Files removed using Reset All cannot be recovered. Handset Code returns to the default setting.

Tools

Calendar

Organise daily, weekly, monthly and yearly schedule.

Save up to 300 entries between Calendar and Tasks (see P.11-18).

Opening Calendar

Main Menu ► Tools

1 Select *Calendar* and press ●

Calendar of the current month opens.

- When Clock is unset, set Time Zone ►
 - Press ● ► Enter the date ► Press ●
 - Enter the time ► Press ● ►
- Calendar opens



■ Key Assignments

	Open the previous month		Cursor left
	Open the next month		Cursor right
	Select the current date		Options
	Cursor up		Exit (Back)
	Cursor down		

Saving Entries

Main Menu ► Tools ► Calendar

1 Select a day and press ●

2 Select *Add New Entry* and press ●

3 Enter subject and press ●

- Enter up to 16 characters.

4 Enter location and press ●

- Enter up to 16 characters.

5 Select a category and press ●

6 Enter start date and press ●

7 Enter start time and press ●

8 Select duration and press ●

- To set end date/time, select *Other* ► Press ● ► Enter date ► Press ● ► Enter time ► Press ●

9 *No Reminder*

1 Select *No Reminder* and press ●

Setting Reminder

1 Select from *At Start time to 1 day before* and press ●

- For custom Reminder Time, select *Other* ► Press ● ► Enter date ► Press ● ► Enter time ► Press ●

10 Select *Description:* and press ●



11 Enter schedule details and press

- Enter up to 128 characters.
- See "Calendar Options" on the right and **P.11-4** to customise schedule related settings.

12 Press **Save**

The entry is saved.

Note ▶ When entries are transferred to other devices, date/time or other information may appear different depending on the recipient device.

Tip ▶  (Reminder set) or  (Reminder unset) appears on scheduled day. (Indicator disappears after scheduled time.)

At Reminder Time

Reminder operates according to the settings.

Stopping Reminder Tone

Press , **Cancel**, ,  or .

Tip ▶ If Reminder Time arrives during a call, no tone will sound. Press  after the call to activate Reminder.

Calendar Options

Follow these steps after Step 11 on the left.





Assign Tone Select tones for Reminder

Default Pattern 1

Preset Sounds

Select Reminder: ▶ Press  ▶ **Select Assign Tone/Video:** ▶ Press  ▶ **Select Assign Tone** ▶ Press  ▶ **Select Preset Sounds** ▶ Press  ▶ **Select a tone** ▶ Press  ▶ Press  **Assign**

My Sounds (Data Folder)

Select Reminder: ▶ Press  ▶ **Select Assign Tone/Video:** ▶ Press  ▶ **Select Assign Tone** ▶ Press  ▶ **Select My Sounds** ▶ Press  ▶ **Select a tone** ▶ Press 



Assign Video Set a video file to play with Reminder

Select Reminder: ▶ Press  ▶ **Select Assign Tone/Video:** ▶ Press  ▶ **Select Assign Video** ▶ Press  ▶ **Select a video file** ▶ Press 

Duration Set how long Reminder operates

Default 15 seconds

Select Reminder: ▶ Press  ▶ **Select Duration:** ▶ Press  ▶ **Select time** ▶ Press 

▶ For custom Duration, select **Other** ▶ Press  ▶ Enter time ▶ Press 

Repeat

Assign schedule type (once only, daily, weekly, monthly or yearly) for each event

Default Once Only

Once Only Schedule

Select **Repeat**: → Press **⊙** → Select **Once Only** → Press **⊙**

Repetitive Schedule

Select **Repeat**: → Press **⊙** → Select from **Day to Every Year** → Press **⊙** → Enter repeat time (00 - 99 times) → Press **⊙**

- Start date and time are reflected in the items. For **Month**, if the day is 29, 30 or 31, entries are saved for the valid months only.
- Repeat time is not available for **Every Year**; the schedule is repeated until deleted.
- Set Repeat time to **00** to repeat until deleted.

Secret

Set Secret mode for entries

Default Off

Select **Secret**: → Press **⊙** → Choose **On or Off** → Press **⊙**

- Secret mode entries appear only when handset is in Secret mode (see P.10-12).

Opening Entries

Main Menu ▶ *Tools* ▶ *Calendar*

- 1 Select a date and press **⊙**
- 2 Select an entry and press **⊙**
- 3 Press **⏪** **Back** to end

Memory Status

Open Calendar or an entry, and follow these steps.

Press **⏪** **Options** → Select **Memory Status** → Press **⊙**

Editing Entries

Main Menu ▶ *Tools* ▶ *Calendar* ▶ *Select an entry*

- 1 Press **⏪** **Options**
- 2 Select **Edit** and press **⊙**
- 3 Select an item and press **⊙**
 - See "Saving Entries" on P.11-2 - 11-3 for more.
- 4 When finished editing, press **⏪** **Save**

Deleting Entries**This Appointment**

Delete one entry

Main Menu ▶ *Tools* ▶ *Calendar* ▶ *Select an entry*

Press **⏪** **Options** → Select **Delete** → Press **⊙** → Select **This Appointment** → Press **⊙** → Press **⏪** **Yes**

All This Day

Delete all entries of the day

Main Menu ▶ *Tools* ▶ *Calendar* ▶ *Select a date*

Press **⏪** **Options** → Select **Delete** → Press **⊙** → Select **All This Day** → Press **⊙** → Press **⏪** **Yes**

All This Month

Delete all entries of the month

Main Menu ▶ *Tools* ▶ *Calendar* ▶ *Select a month*

Press  **Options** ▶ **Select Delete** ▶ Press  ▶
Select All This Month ▶ Press  ▶ Press  **Yes**

- **All This Month** appears only when there is an entry in the month.

Up to Last Month

Delete entries up to the end of the previous month

Main Menu ▶ *Tools* ▶ *Calendar*

Press  **Options** ▶ **Select Delete** ▶ Press  ▶ **Select Up to Last Month** ▶ Press  ▶ Press  **Yes**

- **Up to Last Month** does not appear when there is no entry up to the end of the previous month.



All Appointments

Delete all entries

Main Menu ▶ *Tools* ▶ *Calendar*

Press  **Options** ▶ **Select Delete** ▶ Press  ▶ **Select All Appointments** ▶ Press  ▶ Press  **Yes**

Tip ▶ **Delete another Entry?** appears when repetitive schedules are included, except for **All Appointments**.

- To delete, press  **Yes**.
- To retain repetitive entries, press  **No**.

Alarm

Setting Alarm

Set Alarm to sound at a specific time once, each day or on specific days of the week.

- Save up to 5 Alarm settings.
- Customise Duration, Alarm Volume, Alarm Tone and Vibration.

Main Menu ▶ *Tools* ▶ *Alarms*

1 Select an entry and press 

2 Enter time and press 

3 Select **Repeat:** and press 

4 *Every Day*

1 Select **Every Day** and press 

Specified Day of the Week

1 Select **Selected Days** and press 

2 Select a day of the week and press 

The day is set and appears.

- To cancel, highlight the selected day and press .

3 Repeat **2** to select more

4 Press  **Save** when finished

Once Only

1 Select **Once Only** and press 

5 Press Save

Alarm is set.

- For more settings, repeat Steps 1 - 5.

6 Press to exit

Standby returns and appears.

At Alarm Time

Alarm is activated, sounding/vibrating, etc. according to related settings. Image appears if System Graphics is set. However, SMAF file images take priority over System Graphics.

Stopping Alarm Tone

Press **Cancel**, , , or **Cancel**.

Snooze

When Snooze (see right) is set, Alarm repeats at the set interval.

- Press **Cancel** or to cancel Snooze.
- Accept incoming calls. After each call, press to reactivate Snooze.
- Snooze is cancelled automatically 60 minutes after initial Alarm Time.

Tip ▶ If Alarm Time arrives during a call, no tone will sound. Press after the call to reactivate Alarm.

Alarm Options

Assign Alarm Tone

Select tones for Alarm

Default Pattern 1

Main Menu

▶ *Tools* ▶ *Alarms* ▶ *Open an entry* ▶ *Assign*
Tone/Video:

Preset Sounds

Select **Assign Alarm Tone** ▶ Press ▶ Select **Preset Sounds** ▶ Press ▶ Select a tone ▶ Press ▶ Press **Assign**

My Sounds (Data Folder)

Select **Assign Alarm Tone** ▶ Press ▶ Select **My Sounds** ▶ Press ▶ Select a tone ▶ Press

Assign Alarm Video

Set a video file to play with Alarm

Main Menu

▶ *Tools* ▶ *Alarms* ▶ *Open an entry* ▶ *Assign*
Tone/Video:

Select **Assign Alarm Video** ▶ Press ▶ Select a video file ▶ Press

Snooze

Alarm operates repeatedly after Alarm Time

Default Every 5 minutes

Main Menu

▶ *Tools* ▶ *Alarms* ▶ *Open an entry* ▶ *Snooze*:

Select an interval ▶ Press

- ▶ For custom intervals, select **Other** ▶ Press ▶ Enter interval ▶ Press

Alarm Volume Select Alarm Volume from seven levels

Default Level:5

Main Menu ▶ Tools ▶ Alarms ▶ *Open an entry* ▶ Alarm Volume:

Select a level ▶ Press ●

Duration Select duration for Alarm

Default 10 seconds

Main Menu ▶ Tools ▶ Alarms ▶ *Open an entry* ▶ Duration:

Select duration ▶ Press ●

■ For custom Duration, select **Other** ▶ Press ● ▶ Enter time ▶ Press ●

Vibration Handset vibrates at Alarm Time

Default On

Main Menu ▶ Tools ▶ Alarms ▶ *Open an entry* ▶ Vibration:

Select **On**, **Link to Sound** or **Off** ▶ Press ●

lab Cancelling & Reactivating Alarm

Switch Off Cancel Alarm and retain the settings

Main Menu ▶ Tools ▶ Alarms ▶ *Select an entry*

Press ⏏ **Options** ▶ Select **Switch Off** ▶ Press ●

- 🔔 disappears.
- Reactivate Alarm to use the same settings.

Switch On Reactivate Alarm with the same settings, or change current settings

Main Menu ▶ Tools ▶ Alarms ▶ *Select an entry*

Press ⏏ **Options** ▶ Select **Switch On** ▶ Press ●

- To change settings, press ⏏ **Options** ▶ Select **Select** ▶ Press ● ▶ Edit settings (see P.11-5)

lab Deleting Alarm

Reset Alarm Delete Alarm setting one by one

Main Menu ▶ Tools ▶ Alarms ▶ *Select an entry*

Press ⏏ **Options** ▶ Select **Reset Alarm** ▶ Press ●

▶ Press ⏏ **Yes**

Clear All Delete all Alarm settings

Main Menu ▶ Tools ▶ Alarms

Select **Clear All** ▶ Press ● ▶ Press ⏏ **Yes**

Calculator

Use Calculator for basic arithmetic (up to 12 digits) and percentage calculation, or currency conversion (Money Converter).

Key Assignments

+ (Add)		CM (Clear Memory)	
- (Subtract)		RM (Recall Memory)	
x (Multiply)		M+ (Add Memory)	
÷ (Divide)		. (Decimal)	
= (Equal)		+/- (Switch)	
C•CE (Clear)		% (Percent)	

* Press **Options** to use these functions.

Main Menu ▶ **Tools**

1 Select *Calculator* and press

- Use Keypad to enter numbers, and the assigned keys to calculate.

2 Press to end

Money Converter

■ For conversion between domestic and foreign currencies, follow these steps after entering numbers. Conversion is based on the preset exchange rate.

Press **Options** ➔ **Select Money Converter** ➔

Press ➔ **Select to Domestic or to Foreign** ➔

Press

■ To change exchange rate, open Calculator and follow these steps. Exchange rate of 1:1 is set by default.

Press **Options** ➔ **Select Money Converter** ➔

Press ➔ **Select Exchange Rate** ➔ Press ➔

Select Domestic or Foreign ➔ Press ➔ **Enter**

rate ➔ Press



Tip ▶

- Incoming calls clear calculations. However, values saved in Memory remain.
- Clear Memory before starting Memory calculations.
- Numbers saved in Memory remain even if Calculator is closed, but are cleared when handset power is turned off.

Voice Recorder

Recording Voice

Use handset microphone to record voice onto SD Memory Card.

- Make sure battery is adequately charged. When battery is low (), Voice Recorder does not record. If battery becomes low () while recording, Voice Recorder shuts down automatically.
- Select **For Message** to attach to MMS messages, or **Extend Voice** to record up to 99 hours, 59 minutes and 59 seconds.
- To save recorded voice to handset memory, select **For Message**.
- Conversations during calls cannot be recorded.
- If incompatible microphone is connected, recording may fail.

Main Menu ▶ Tools

1 Select Voice Recorder and press

Recording window opens.

▶ Record Time: see P.11-10

2 Press

Recording starts.



3 Extended Voice

1 Press

Recording is saved to SD Memory Card.

- To resume recording, press .

Recording is saved as a new file.

For Message

1 Press

- Recording stops automatically when maximum recording time is reached.

▶ To play the recording, select **Playback** ▶ Press 

- Press  **Pause** to pause.

▶ To start over without saving, press  **Cancel** ▶ Repeat from Step 2

▶ To attach to a MMS message, select **Save and Send** ▶ Press  ▶ See P.14-9

- When **Choice** is selected in **Save Rec. to** setting, select **Handset Memory** or **Memory Card** ▶ Press  ▶ See P.14-9

2 Select Save and press

▶ When **Choice** is selected in **Save Rec. to** setting, select **Handset Memory** or **Memory Card** ▶ Press 

Note ▶ • Do not subject handset to shocks. May cause noise or skipping.

• Recording window may take long to open depending on the amount of information on SD Memory Card.

Tip ▶ • Default file name is also the recorded date and time, which can be changed afterwards.

• Alarm is disabled while recording, and starts when finished.

Recording Settings

Record Time Select *Extended Voice* or *For Message*

Default: For Message

Main Menu ▶ *Tools* ▶ *Voice Recorder*

Press **Options** ▶ Select *Record Time* ▶ Press **Enter** ▶
Select *Extended Voice* or *For Message* ▶ Press **Enter**

Save Rec. to Select storage media for *For Message*

Default: Handset Memory

Main Menu ▶ *Tools* ▶ *Voice Recorder*

Press **Options** ▶ Select *Save Rec. to* ▶ Press **Enter** ▶
Select *Handset Memory*, *Memory Card* or *Choice*
▶ Press **Enter**

- Set to *Choice* to select media after every recording.

Playback

- Sounds play from handset speaker.
- Alternatively, use Multi Stereo Headphones (see **P.7-3**).

Main Menu ▶ *Tools* ▶ *Voice Recorder*

1 Press Options

2 Select My Sounds and press Enter

3 Select a file and press Enter

Playback starts.

Use **Up** (up) or **Down** (down) to adjust volume.



Incoming Calls/Mail during Playback

- When calls arrive, playback stops and Ringtone sounds.
- For handset responses to incoming mail, see **P.7-4**.

Barcode

Scan printed barcodes with mobile camera or download QR Codes via Web or MMS.

- Handset automatically detects code type and reads code data.
- In Continuous Scan mode, scan up to 50 UPC (JAN) or 16 QR Codes at one time. In some cases, continuous scans may be disrupted depending on barcode data or data size.
- Zoom function is not available.

- Tip** ▶
- UPC (Universal Product Code) or JAN (Japanese Article Number) is a series of varying width vertical lines (called bars) and spaces. Bars and spaces together are *elements*, combinations of which represent different numbers. Handset cannot read other one-dimensional barcodes (ITF Code, Code39, Codabar/NW-7, etc.).
 - QR (Quick Response) Code is a matrix symbology consisting of an array of nominally square cells. It allows omni-directional reading of up to 7,366 characters—numeric, alphanumeric, byte data as well as kanji and kana.

Main Menu ▶ Barcode ▶ Scan Barcode

1 Frame barcode in the centre of Display

- Keep handset approximately 10 cm away from the barcode.
 - Slide Portrait/Macro Selector to Macro to scan barcodes.
- Press to use Mobile Light.

2 Press

Mobile camera scans the barcode.

To stop scan, press **Cancel** ▶ Repeat from Step 1

3 Barcode recognition tone sounds and scan results appear

Using Scan Results: see P.11-12

To start over, while scan results appear, press **Back** ▶
Press **Yes** ▶ Repeat from Step 1

Note ▶ If handset temperature is too high, **Heat warning: camera temporarily disabled.** appears and mobile camera cannot be activated. If handset temperature becomes too high while scanning, **Temperature is high. Closing camera...** appears and scanning ends.

Continuous Scan

After scanning, **Scan complete scan new?** appears.

- To continue scanning
Press **Yes** → Frame barcode in the centre of Display → Press
- To exit
Press **No** → Scan results appear

Split Data

■ After scanning, **Split data scan next symbol?** appears.

- To continue scanning
Press **Yes** → Frame barcode in the centre of Display → Press
- To exit
Press **No** → **Delete all information, OK?** appears → Press **Yes**

■ Data will not be saved until all split data is scanned.

■ The scanning status appears on the first line of Display. For example, indicates that 1 of 4 codes has been scanned.

- Note** ▶
- Scanning may fail if the barcode is smudged or unclear.
 - It is recommended to use Mobile Light when scanning barcodes indoors.
 - Capture one barcode at a time. Otherwise handset may fail to scan.

Using Scan Results

Place Calls¹	Select a number starting with TEL: ² → Press → The number appears → Press
Send Mail³	Select a mail address including @ → Press → New Message window opens (See P.14-7 for more.)
Quote & Send Mail	Press Options → Select Send Message → Press → Preview appears → Press → To use a part of text, press Options → Select Send Message → Press → Preview appears → Press Options → Select Cut → Press → Highlight the first character of the text block to cut → Press → Highlight the text block → Press (See P.14-7 for more.)
Save to Phone Book^{1,3}	Select a number starting with TEL: ² or a mail address including @ → Press Options → Select Save to Ph.Book → Press
Access Mobile Internet Sites⁴	Select a URL starting with http:// or rtsp:// → Press (Handset connects to the Network.)
Save to Data Folder (Images & Melodies)	Select an image or melody file → Press Options → Select To Data Folder → Press

¹Available when text is in **TEL:*** format.

²Text strings of 10 to 24 digits starting with 0 are recognised as phone numbers.

³Available when text is in ***@*** format.

⁴Available when text is in **http://*** or **rtsp://*** format.

* represents one or more alphanumeric.

Save to Scanned Results	Press Options ➔ Select Save ➔ Press Enter <ul style="list-style-type: none"> • Save up to 10 items.
Copy Text	Press Options ➔ Select Copy ➔ Press Enter ➔ Highlight the first character of the text block to copy ➔ Press Enter ➔ Highlight the text block ➔ Press Enter <ul style="list-style-type: none"> • Paste the copied text into a text entry window.

Note ▶ Operations (dialling, sending messages, etc.) are available only when **TEL:**, **@ http://** or **rtsp://** is attached.

Tip ▶ When **MEMORY:** or **MAILTO:** appears in scan results, press **Enter** to save underlined text to Phone Book or send messages. All underlined items are entered. However, text after an invalid character is not underlined and is not copied.

Scanning during Text Entry Insert scan results into current cursor position

In a text entry window, press **Options ➔ Select **Scan** ➔ Press **Enter** ➔ Select **Scan Code** ➔ Press **Enter** ➔ Frame barcode in the centre of Display ➔ Press **Enter****

Note ▶ Barcodes/text cannot be scanned when:

- Entering text during a call
- Saving scan results or during infrared transmission
- Using E-Book
- V-application is active
- Entering URL for Streaming

Open Barcode Read saved barcode images in Data Folder

Main Menu ▶ **Barcode** ➔ **Open Barcode**

Select a barcode image ➔ Press **Enter**

- For split data, press **Options** **Yes** to scan next code.
 - To cancel, press **Back** ➔ **Delete all information, OK?** appears ➔ Press **Options** **Yes**
- When scanning fails, select next barcode image manually ➔ Press **Enter**

Note ▶

- Resized QR Codes may not be scanned.
- For invalid codes, **This data may be incorrect.** appears.

Scanned Results Open files saved in Scanned Results

Main Menu ▶ **Barcode** ➔ **Scanned Results**

Select a file ➔ Press **Enter**

- The file cannot be re-saved.

Creating QR Codes

Create QR Codes from entered text, Phone Book, Pictures, Sound & Ringtones, and Text Templates.

- Save up to the equivalent of 513 digits or 131 kanji per QR Code.
- Large size items are divided into maximum of 16 QR Codes.
- Created QR Codes are saved to Data Folder (Pictures).

Phone Book

Encode name, reading, phone numbers, mail addresses and note

Main Menu ▶ Barcode ▶ Create QR Code ▶ Phone Book

Select an entry ▶ Press ● ▶ **QR Code appears** ▶ Press ⏏ **Options** ▶ **Select Save** ▶ Press ●

- Only name, reading, phone numbers, mail addresses and note are encoded.

Text Input

Enter and encode text

Main Menu ▶ Barcode ▶ Create QR Code ▶ Text Input

Enter text ▶ Press ● ▶ **QR Code appears** ▶ Press ⏏ **Options** ▶ **Select Save** ▶ Press ●

Data Folder

Encode melody/image files or Text Templates in Data Folder

Main Menu ▶ Barcode ▶ Create QR Code ▶ Data Folder

Select a folder ▶ Press ● ▶ **Select an item** ▶ Press ● ▶ **QR Code appears** ▶ Press ⏏ **Options** ▶ **Select Save** ▶ Press ●

Switching Storage Media

Before saving, press ⏏ **Options** ▶ **Select Save To** ▶ Press ● ▶ **Select Handset or Memory Card** ▶ Press ●

Attaching to MMS Mail

Before saving, press ⏏ **Options** ▶ **Select Send As** ▶ Press ● (See P.14-7 for more.)

Incoming Calls while Creating

Contents are temporarily saved. End the call to return.

Text Scanner

Scan text (URLs, mail addresses, phone numbers or roman letters) with mobile camera.

- Scan up to 60 single-byte characters within 3 lines. Scanning over 35 characters at one time may yield poor results.
- Some symbols cannot be read.
- Zoom function is not available.

- Note** ▶
- Text Scanner is disabled while music plays or V-application is active. When a confirmation to stop the function appears, press  **Yes** to proceed.
 - If handset temperature is too high, **Heat warning: camera temporarily disabled.** appears and Text Scanner cannot be activated. If handset temperature becomes too high while scanning, **Temperature is high. Closing camera...** appears and scanning ends.

1 Frame text in the centre of Display

- Adjust to frame text in []. Letters at the ends may be distorted.
 - Text mode in Reversed Text setting is set to **Auto** each time Text Scanner is activated. Change the mode if text is distorted in **Auto** (such as white text in black background).
 - Keep handset approximately 10 cm away from text.
 - Slide Portrait/Macro Selector to Macro to scan fine text.
- Press  to use Mobile Light.

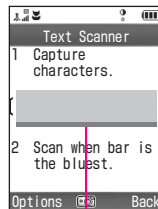

Focus Adjustment Bar (Better focus in darker blue)

2 Press

Mobile camera scans text.

- ▶ To stop scan, press  ▶ Repeat from Step 1

3 Use to select a line and press

- Text Scanner reads one line per scan.

4 Scan results appear

Handset automatically recognises scan results as a URL, Email Address, Phone Number or Text. If handset setting is incorrect, select the correct mode.

■ To change mode, press **Options** ➔ Select **Change Mode** ➔ Press ➔ Select a type ➔ Press (Scan results and alternatives list change accordingly.)

■ To edit, press **Options** ➔ Select **Select/Edit** ➔ Press ➔ Text entry window opens ➔ Move cursor to the character to edit ➔ Select an alternative from the list or enter the correction directly from Keypad

■ To start over, press **Back** ➔ Press **Yes** ➔ Repeat from Step 1

Tip ▶ **If Text Exceeds Limit**
Results appear with overage truncated.

5 Press

- Scan results can be used as follows:

URL	Access Mobile Internet, copy
Email address	Send mail, save to Phone Book, copy
Phone Number	Dial, save to Phone Book, copy
Text	Copy

■ Using Scan Results: see P.11-12

- Tip** ▶
- Follow these steps to scan more.
 - Press **Options** ➔ Select **Continue Part or Scan More** ➔ Press
 - Continue Part
Select **Continue Part** to enter additional text. (Mode remains the same.)
 - Scan More
Select **Scan More** to enter text after a line break.
 - **Continue Part** and **Scan More** are disabled once 256 characters have been scanned.

Scanning during Text Entry Insert scan results into current cursor position

In a text entry window, press **Options** ➔ Select **Scan** ➔ Press ➔ Select **Text Scanner** ➔ Press ➔ Frame text in the centre of Display ➔ Press ➔ Select a line ➔ Press

Stopwatch

Record elapsed time for up to 24 hours (23 hours, 59 minutes and 59.9 seconds) in 0.1-second increments.

Use lap time feature to segment elapsed time.

- Save times (including the last four lap times) to handset Text Templates.
- Stopwatch ends when battery level is low.

Main Menu ▶ Tools ▶ Stopwatch

1 Press



Stopwatch starts.

- To record lap times, press  **LAP**.
- The last four lap times are recorded. The records are deleted when Stopwatch is cancelled.

2 Press to stop

- To save the records to Text Templates, press  **Options** → Select **Save to Template** → Press 
- To check saved records, open Text Templates (see P.8-13).
- Press  to resume Stopwatch.
- To clear the record, press  **Options** → Select **Reset** → Press 

3 Press **Back** to exit

- To end Stopwatch when recording or stopped, press  **Back**
 - Press  **Yes**

- Tip** ▶
- Records are deleted when Stopwatch is cancelled. Save records to Text Templates.
 - Stopwatch is not affected by incoming calls. Press  after the call to return to Stopwatch.
 - If Alarm Time arrives when Stopwatch window is open, no tone will sound. Cancel Stopwatch to activate Alarm (see P.11-5).

Tasks

Save event with deadlines. Check completed tasks.
Save up to 300 entries between Tasks and Calendar (see P.11-2).

Saving Entries

Main Menu ▶ Tools ▶ Tasks

- 1 Select **Add New Entry** and press ●
 - 2 Enter subject and press ●
 - Enter up to 16 characters.
 - 3 Enter due date and press ●
 - 4 Enter due time and press ●
 - 5 **No Reminder**
 - 1 Select **No Reminder** and press ●
- Setting Reminder**
- 1 Select from **At Due Time** to **1 day before** and press ●
 - For custom Reminder Time, select **Other** ▶ Press ●
 - ▶ Enter date ▶ Press ● ▶ Enter time ▶ Press ●
- 6 Select **Description:** and press ●
 - 7 Enter task details and press ●
 - Enter up to 128 characters.
 - See P.11-19 "Tasks Options" to customise task related settings, such as Reminder tone, Repeat or Secret mode setting, etc.

8 Press [Save]

The entry is saved.

At Reminder Time

Reminder operates according to the settings.

Stopping Reminder Tone

Press [Cancel], [Mute], [End Call] or [End Call].

Tip ▶ If Reminder Time arrives during a call, no tone will sound. Press [Mute] after the call to activate Reminder.

Tasks Options

Follow these steps after Step 7 on P.11-18.

Assign Tone

Select tones for Reminder

Default Pattern 1

Preset Sounds

Select *Reminder*: ➔ Press **⊙** ➔ Select *Assign Tone/Video*: ➔ Press **⊙** ➔ Select *Assign Tone* ➔ Press **⊙** ➔ Select *Preset Sounds* ➔ Press **⊙** ➔ Select a tone ➔ Press **⊙** ➔ Press **⏪** **Assign**

My Sounds (Data Folder)

Select *Reminder*: ➔ Press **⊙** ➔ Select *Assign Tone/Video*: ➔ Press **⊙** ➔ Select *Assign Tone* ➔ Press **⊙** ➔ Select *My Sounds* ➔ Press **⊙** ➔ Select a tone ➔ Press **⊙**

Assign Video

Set a video file to play with Reminder

Select *Reminder*: ➔ Press **⊙** ➔ Select *Assign Tone/Video*: ➔ Press **⊙** ➔ Select *Assign Video* ➔ Press **⊙** ➔ Select a video file ➔ Press **⊙**

Duration

Select duration time for Reminder

Default 15 seconds

Select *Reminder*: ➔ Press **⊙** ➔ Select *Duration*: ➔ Press **⊙** ➔ Select time ➔ Press **⊙**
■ For custom Duration, select *Other* ➔ Press **⊙** ➔ Enter time ➔ Press **⊙**

Secret

Set Secret mode for entries

Default Off

Select *Secret*: ➔ Press **⊙** ➔ Choose *On or Off* ➔ Press **⊙**
• Secret mode entries appear only when handset is in Secret mode (see P.10-12).

Opening Entries

Main Menu ▶ Tools ▶ Tasks

1 Use **⊙** to select **⊙** (all entries), **☑** (checked) or **☐** (unchecked)

- Entries with a check appear in **☑**, entries without a check appear in **☐**.

2 Select an entry and press **⊙**

- To check, press **⊙**.
- To uncheck, press **⊙**.

3 Press **⏪** **Back** to end

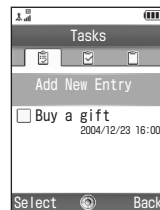

Memory Status

Check the number of saved entries.

Select an entry and press **⏪** **Options** ➔ Select *Memory Status* ➔ Press **⊙**

Editing Entries

Main Menu ▶ Tools ▶ Tasks ▶ Select an entry

1 Press **⏪** **Options**

2 Select *Edit* and press **⊙**

3 Select an item and press **⊙**

- See "Saving Entries" on P.11-18 for more.

4 When finished editing, press **⏪** **Save**

Deleting Entries

This Task Delete one entry

Main Menu ▶ Tools ▶ Tasks ▶ *Select an entry*

Press **Options** ▶ Select **Delete** ▶ Press ▶
Select **This Task** ▶ Press ▶ Press **Yes**

All Completed Tasks Delete all checked entries

Main Menu ▶ Tools ▶ Tasks

Press ▶ Press **Options** ▶ Select **Delete** ▶
Press ▶ Select **All Completed Tasks** ▶ Press
▶ Press **Yes**

- **All Completed Tasks** appears only when there is a checked entry.

All Tasks Delete all entries

Main Menu ▶ Tools ▶ Tasks

Press ▶ Press **Options** ▶ Select **Delete** ▶ Press
 ▶ Select **All Tasks** ▶ Press ▶ Press **Yes**

World Clock

Display local time and the time of another area in the world.

- World Clock supports Daylight Saving time.
- Select **World Clock** for Clock & Calendar setting to use World Clock in Standby (see P.10-5).

Time Zone

Select from preset Time Zones or specify a new one by entering area name and time difference between the area and the local area.

Main Menu ▶ Tools ▶ World Clock ▶ *Edit* () ▶ Set Time Zone

1 Use to specify an area and press

- ▶ To add Time Zones, in Time Zone setting window, press **Options** ▶ Select **Set Custom Zone** ▶ Press ▶ Enter city name ▶ Press ▶ Enter time difference ▶ Press

Daylight Saving

Activate Daylight Saving to advance the selected area's time by one hour.

Main Menu ▶ Tools ▶ World Clock ▶ *Edit* () ▶ Daylight Saving

1 Choose **On** and press



- ▶ To cancel, choose **Off** ▶ Press



Countdown Timer

Set Countdown Timer up to 60 minutes in 1-second increments. Alarm Tone sounds and Small Light flashes when set time elapses.

Main Menu ▶ Tools ▶ Countdown Timer

1 Enter time (00:01 - 60:00) and press

- To edit entered time, use  to move cursor and enter correct time. If  is already pressed, follow the steps below.
- When times over 60 minutes (60:00) are entered, Countdown Timer returns to 00:00.

■ To change time, press  **Options** ▶ Select **Edit** ▶ Press 
▶ Enter time ▶ Press 

2 Press

Countdown starts.



3 Press to stop countdown

■ Press  to resume.

4 Press **Back** and then **Yes** to exit

Countdown Timer End

Timer Expired appears. Vibration activates and Alarm Tone sounds according to the settings.

- Alarm stops automatically after 60 seconds. Press  **Cancel** to stop manually.
- Manner settings take priority over.
- When the set timer time elapsed during a call, **Timer Expired** appears after  is pressed to end the call.

Tip ▶

- Countdown is not affected by incoming calls. Press  after the call to return to Countdown Timer window.
- If Alarm Time arrives while Countdown Timer window is open, no tone will sound. Cancel Countdown Timer to activate Alarm.
- Pen Light is disabled while Countdown Timer window is open.

Expenses Memo

Use Expenses Memo to add expenses, such as travel expenses.

- Enter up to 30 entries (up to 29,999,999.7 yen in total, 999,999.99 yen per entry).
- Expenses Memo cannot be opened during a call.

Add New Expense

Enter monetary figure and categorise it

Main Menu ▶ Tools ▶ Expenses Memo ▶ Add New Expense

Enter amount ▶ Press **⊙** ▶ Select a category ▶ Press **⊙**

- The entry date and figure are saved.
- If Clock is unset (see **P.10-7**), entry date and time will be saved as --/-- --:--.

Totals

Check entries

Main Menu ▶ Tools ▶ Expenses Memo

Select **Totals** ▶ Press **⊙**

- Use **⬇** to scroll through entries.
- To change category names, select an entry ▶ Press **⌂** **Options** ▶ Select **Change Category** ▶ Press **⊙** ▶ Edit ▶ Press **⊙**
 - Enter up to 14 characters.
- To change entry amount, select an entry ▶ Press **⌂** **Options** ▶ Select **Change Amount** ▶ Press **⊙** ▶ Edit ▶ Press **⊙**
- To delete an entry, select an entry ▶ Press **⌂** **Options** ▶ Select **Delete Item** ▶ Press **⊙** ▶ Press **⌂** **Yes**
- To delete all entries, select an entry ▶ Press **⌂** **Options** ▶ Select **Delete All** ▶ Press **⊙** ▶ Press **⌂** **Yes**

Edit Category

Rename categories

Main Menu ▶ Tools ▶ Expenses Memo

Select **Edit Category** ▶ Press **⊙** ▶ Select a category ▶ Press **⊙** ▶ Edit ▶ Press **⊙**

- Enter up to 14 characters.

Digital Print Order Format (DPOF)

Digital Print Order Format (DPOF) is a standard specification for requesting prints from digital cameras.

Select images from SD Memory Card and specify the number of copies to print on DPOF-compatible printers, or at digital printing services.

- DPOF does not support images downloaded via Web or MMS.
- If SD Memory Card capacity becomes insufficient during operation, a warning message appears. Delete files and try again.
- For printing procedures, see the printer manual.

Selecting Images & Prints

To specify same number of copies for all DCF images on SD Memory Card, see right.

Main Menu ▶ Tools ▶ Photo Print ▶ Picture Setting

1 Select a folder and press

Thumbnails appear.

2 Use to select an image and press **Count**

3 Enter a number of copies to print (00 - 99) and press

To cancel, enter **00** ▶ Press 

4 Repeat Steps 2 - 3 for other images

5 Press **OK**

- Note** ▶
- Print settings made on other devices cannot be changed on handset.
 - Print settings on handset replace those made on other devices.
 - Some settings may not be supported depending on the printer or printing services.
 - Process may take a while if print settings are made for many images.
 - If image files are deleted or renamed on PCs or other devices, print settings change. Perform Cancel All and start over with settings.

Print Settings

Add Date Add dates to prints

Default Off

Main Menu ▶ Tools ▶ Photo Print ▶ Settings

Select **Add Date** ▶ Press  ▶ Choose **On** (add date) or **Off** (no date) ▶ Press 

Index Print Create Index Print (a print with thumbnails)

Default Off

Main Menu ▶ Tools ▶ Photo Print ▶ Settings

Select **Index Print** ▶ Press  ▶ Choose **On** (create Index Print) or **Off** ▶ Press 

Check Print Setting View current print settings

Main Menu ▶ Tools ▶ Photo Print ▶ Settings

Select **Check Print Setting** ▶ Press 
• ******* may appear for **Images** and **Total Copies**.

Number of Copies Specify same number of copies for all DCF images at once

Main Menu ▶ Tools ▶ Photo Print ▶ Settings

Set All at Once

Select **Number of Copies** ▶ Press  ▶ Enter a number (01 - 99) ▶ Press 

Cancel All Print Settings

Select **Cancel All** ▶ Press  ▶ Press  **Yes**

E-Books

Read a variety of E-Books (XPDF or Text format) on SD Memory Card.

- Use handset as a dictionary by saving dictionary files.
- For details, access Sharp's **Space Town** Mobile Internet site (see **P.13-11**).
- Handset may not support sounds or images embedded in E-Books.

Reading Content

Main Menu ▶ Tools

1 Select **E-Book** and press **⏏**

Book contents list appears. (When you press **⏏** to close Reading window, the same page will open next time.)

- When playing sound, confirmation appears ▶ Press **⏏** **Yes** (Book data list or the last page you opened appears.)
- To read E-Books saved in other folders, press **⏏** **Options** ▶ Select **Change Folder** ▶ Press **⏏** ▶ Select a folder ▶ Press **⏏** (The selected folder will open next time.)
- Press **⏏** **Options** ▶ Select **Property** ▶ Press **⏏** to see the title, author, etc.

2 Select content and press **⏏**













- ○% indicates location of the current page.
- If content is password protected, enter password ▶ Press **⏏** ▶ Reading window opens

3 Press **⏏** to close

- The last page you opened will appear next time.





- Note** ▶
- E-Books cannot be opened while sounds play or a V-application is paused.
 - E-Books automatically close for incoming calls, at Alarm Time, when battery is low, or after five minutes of inactivity.
 - Only files with **zbf**, **zbk**, **txt** or **text** extension appear in book contents list.
 - Revised E-Books are not supported.

Folders and Files













- Adding Folders
In book contents list, press  **Options** → Select **New Folder** → Press  → Enter folder name → Press 
- Editing Folder/File Names
In book contents list, select a folder/file → Press  **Options** → Select **Change Name** → Press  → Edit → Press 
- Deleting Folders/Files
In book contents list, select a folder/file → Press  **Options** → Select **Delete** → Press  → Press  **Yes**
- Moving Files
In book contents list, select a file → Press  **Options** → Select **Move** → Press  → Select a location → Press  twice

Key Assignments

- Operations vary by writing style as follows.

	Lateral	Vertical
	Scroll up (by line)	Backward (by page)
	Scroll down (by line)	Forward (by page)
	Backward (by page)	Scroll left (by line)
	Forward (by page)	Scroll right (by line)

Text Operations

- Jump to the first or last page.
Press  **Options** → Select **Home or End** → Press 
- Move to a specific location.
Press  **Options** → Select **% Shift** → Press  → Enter location by percentage (00 - 99) → Press 
- Select chapter when a table of contents is contained.
Press  **Options** → Select **Contents** → Press  → Select a chapter → Press 
- See P.11-26 to use Bookmarks.
- Reading window settings:
Press  **Options** → Select **Display Settings** → Press  → Select an item → Press  → Change the setting → Press 

Item	Description	Default
Font Size	Select <i>Tiny</i> , <i>Small</i> , <i>Standard</i> or <i>Standard Plus</i>	Standard
Text Direction	Read text vertically or horizontally	Vertical Text
Ruby	Show ruby annotations	Off

- Above settings are not available for some content.

Using Linked Info/Copying Text

■ Use numbers, addresses or URLs to place calls, send MMS messages or access Mobile Internet sites.

Select an item ➔ Press  **Options** ➔ **Select Jump To Link** ➔ Press  ➔ Press  **Yes**

- Some linked information may not be used.





■ Copy text in data (up to 20 double or single-byte characters).

In Reading window, press  **Options** ➔ **Select Copy** ➔ Press  ➔ **See P.3-14 for more**

- Text in index window and search results list of dictionary files cannot be copied.
- Images and ruby annotations cannot be copied.

Mask & Jump

Some content may contain hidden text or images (masked info) or links (jump links).

- Select a part with masked info and press  to show the text or image. Press  again to hide.
- Select a part with jump link and press  to jump to the specified page. Press  **Back** to return to the original location.

Bookmark

Add bookmarks to return to the pages easily.

Use two bookmarks per E-Book (for up to five E-Books).

1 Press  **Options**

2 Select **Bookmark** and press 

3 Select **Bookmark1** or **Bookmark2** and press 

Bookmark is added.

Auto Bookmark

When you close Reading window, Auto Bookmark 1 is added to the last page you opened. The next time you close the same content, Auto Bookmark 1 is replaced with Auto Bookmark 2, and added to the new last page.

- Up to two Auto Bookmarks can be stored per E-Book, and will be deleted older first when another is added.
- E-Books automatically close and Auto Bookmark 1 is added when incoming calls arrive while reading E-Books.

Opening Bookmarked Page

In Reading window, press  **Options** ➔ **Select Move to Bookmark** ➔ Press  ➔ **Select Bookmark1, Bookmark2, Auto Bookmark1 or Auto Bookmark2** ➔ Press 

Using E-Book Images

As Wallpaper

Save images as Wallpaper

Main Menu ► *Tools* ► *E-Book* ► *Open E-Book*

Select an image ► Press  **Options** ► Select *Set as Wallpaper* ► Press  ► Press 

- Some images may not be used.

Embedded Information

Use information contained in images

Main Menu ► *Tools* ► *E-Book* ► *Open E-Book*

Select an image ► Press  **Options** ► Select *Jump To Link, Toggle Mask or Play Animation* ► Press 

Jump To Link	Select jump information to move to other pages. Use linked information to send MMS messages or access Mobile Internet sites (book data will close). See P.11-26 "Using Linked Info/Copying Text".
Toggle Mask	Hidden text or images appear
Play Animation	Flip animation plays

Using A Dictionary

Look Up Word

Use downloaded e-book dictionaries to look up word definitions, etc.

Main Menu ► *Tools* ► *E-Book*

Select a dictionary ► Press  ► Select an entry field ► Press  ► Enter word ► Press 

- Select an entry and press  to view its definitions.
- For key assignments, see P.11-25.

Properties

Open properties of dictionary and other E-Book content

Main Menu ► *Tools* ► *E-Book* ► *Open E-Book*

Press  **Options** ► Select *Property* ► Press 

Phone Help

Open quick guides to functions other than Main Menu functions.

Main Menu ▶ Tools

1 Select *Phone Help* and press

Phone Help window opens.

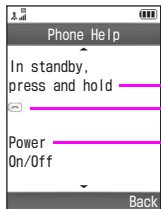

Handset Status and Key Press Method

Operations (Keys)

Function

2 Press

Guide for another function appears.

3 Press **Back** to end

Optional Services

Optional Service Overview

- When handset is out-of-range, access Optional Services from a touch-tone landline.
- For details, contact Vodafone Customer Centre, General Information (see **P.16-32**).

Call Forwarding	When you know you will be unable to receive calls to your handset, use Call Forwarding to automatically transfer calls to another phone number (see right).
Voice Mail	Unanswered calls are forwarded to Voice Mail. Retrieve caller messages from handset or any touch-tone phone, anytime. New Voice Mail indicator appears on handset after message is recorded (see P.12-4).
Call Waiting*	Call Waiting alerts you to incoming calls when the line is already engaged. After the tone, place the current call on hold and answer the second, or alternate between calls (see P.12-5).
Conference Call*	Open a second line while the first is engaged. Switch back and forth between two lines or talk on both simultaneously. Add other parties to an existing conversation and talk on up to five lines simultaneously (see P.12-6).
Call Barring	Restrict incoming/outgoing calls depending on conditions (see P.12-7)
Caller ID	Show or hide your own number when placing calls (see P.12-10)

*A separate subscription is required.

Call Forwarding

Transfer incoming calls to a specified phone number according to the preset forwarding condition and service type.



- Forwarding conditions

All Calls	Transfer all incoming calls immediately
When Busy	Automatically transfer during a call (when Call Waiting is deactivated). Manually transfer calls arrived while handset is ringing/vibrating.
No Answer	Transfer calls if phone is not answered within a set ring time
Not Reachable	Transfer all incoming calls when your handset is turned off or out-of-range

- Call Forwarding and Voice Mail cannot be used at the same time.
- Initiating Call Forwarding cancels Voice Mail.
- Call Forwarding is not available when **All Outgoing Calls** or **All Incoming Calls** in Call Barring is active. (Call Barring takes priority.)

► Settings ► Call Settings ► Diverts ► *Select a forwarding condition*

Choose On ► Press  ► **Select Enter Phone Number** ► Press  ► **Enter a forwarding number** ► Press  ► **Select ring time** ► Press 

■ To specify a service type, select **By Service** ► Press  ► Select an item ► Press 

- Ring time can be set when the forwarding condition is **No Answer**.
- Include the dialling code for landlines.

Tip ► Adjust ring time to set the response priority when using Call Forwarding together with Message Recorder (see **P.2-20**).

Example: Ring time for Call Forwarding: 10 seconds

Ring time for Message Recorder: 9 seconds

In this example, Message Recorder responds first. (Priority may change depending on signal conditions.)

Phone Numbers Beginning with the Following Numbers Cannot be Saved:

- **1** (Public Service Numbers: 110, 119, 118, etc.)
- **00** (International call numbers: 001, 0041, etc.)
- **0120** (Toll Free Number)
- **0990** (Fee-based services: Dial Q2, etc.)

► Settings ► Call Settings ► Diverts

Each Forwarding Condition

Select a forwarding condition ► **Choose Off** ► Press 

All Call Forwarding

Select Cancel All ► Press  ► Press  **Yes**

- If all Call Forwarding settings are cancelled, Voice Mail settings are cancelled at the same time.
- **Done.** appears following **Please wait...**

► Settings ► Call Settings ► Diverts ► *Select a forwarding condition*

Select Status ► Press 

- Call Forwarding status appears.

Incoming Calls while Call Forwarding is Active

To answer calls, press  while handset is ringing/vibrating.

Voice Mail

Transfer incoming calls to Voice Mail according to the preset conditions (same as those for Call Forwarding on P.12-2).

- Calls are transferred to Voice Mail using Call Forwarding function. Therefore, Voice Mail and Call Forwarding cannot be used at the same time.
- For details, contact Vodafone Customer Centre, General Information (see P.16-32).
- Initiating Voice Mail cancels Call Forwarding.
- Call Forwarding is not available when **All Outgoing Calls** or **All Incoming Calls** in Call Barring is active. (Call Barring takes priority.)

Voice Mail

Initiate Voice Mail

Main Menu

▶ Settings ▶ Call Settings ▶ Diverts ▶ *Select a forwarding condition*

Choose **On** ▶ Press **⊙** ▶ Select **Voicemail Serv.** ▶ Press **⊙** ▶ **Voice Mail Centre address appears** ▶ Press **⊙** ▶ **Select ring time** ▶ Press **⊙**

■ To change Voice Mail Centre address, press **⏏** **Options** while it appears ▶ Select **Edit** ▶ Press **⊙** ▶ Change the number (default: 09066517000) ▶ Press **⊙**

- **Done.** appears following **Please wait...**
- Ring time can be set when the forwarding condition is **No Answer**.

Tip ▶ Adjust ring time to set the response priority when using Voice Mail together with Message Recorder (see P.2-20).

Example: Ring time for Voice Mail: 10 seconds

Ring time for Message Recorder: 9 seconds

In this example, Message Recorder responds first.

(Priority may change depending on signal conditions.)

Cancel
Voice Mail

Cancel transferring to Voice Mail

Main Menu

▶ Settings ▶ Call Settings ▶ Diverts

Each Forwarding Condition

Select a forwarding condition ▶ Choose **Off** ▶ Press **⊙**

All Voice Mail

Select **Cancel All** ▶ Press **⊙** ▶ Press **⏏** **Yes**

- If all Voice Mail settings are cancelled, Call Forwarding settings are cancelled at the same time.
- **Done.** appears following **Please wait...**

Status

Check Voice Mail status

Main Menu

▶ Settings ▶ Call Settings ▶ Diverts ▶ *Select a forwarding condition*

Select **Status** ▶ Press **⊙**

- Voice Mail status appears.

Incoming Calls while Voice Mail is Active

To answer calls, press **⏏** while handset is ringing/vibrating.

Play Voice Mail Check Voice Mail messages

Main Menu ► Messages ► Voice Mail

Select **Call Voice Mail** ► Press **⓪**

- Follow the guidance for further operations after handset connects to Voice Mail Centre.
- Alternatively, press **1** for 1+ seconds in Standby to connect to Voice Mail Centre.
 - Press **⓪** to end.

Tip ► **⓪** disappears after messages are checked.

Call Waiting

Separate Subscription Required

Start/Cancel Call Waiting Activate or deactivate Call Waiting

Main Menu ► Settings ► Call Settings ► Call Waiting

Choose **On or Off** ► Press **⓪**

- **Done.** appears following **Please wait...**

Status Check Call Waiting status

Main Menu ► Settings ► Call Settings ► Call Waiting

Select **Status** ► Press **⓪**

- Call Waiting status appears.

Incoming Calls Put Line 1 on hold to answer Line 2

When a tone sounds during a call, press **⓪**

■ Press **⓪** to switch between two lines.

Ending Calls while Someone is on Hold

When **⓪** is pressed or handset is closed, all lines are disconnected.

Line 1 Ends while Line 2 is on Hold

A beep sounds. Press **⓪** to talk with the other party on hold.

- Tip ►
- Handset does not ring or vibrate for incoming calls while a line is engaged. A tone sounds from Earpiece and **Call Waiting** appears.
 - When Voice Mail or Call Forwarding is active, unanswered incoming calls are transferred to Voice Mail or the forwarding number. If **All Calls** is selected, then all calls are transferred directly.

Conference Call

Separate Subscription Required

Dial New Number

Open another line during a call

Enter a phone number during a call → Press 

- Line 2 is open. Line 1 is put on hold.
- Phone Book, Dialed Numbers, Received Calls and Missed Calls are available.

Switch Line

Switch between two open lines

During a call, press 

- The line switches. The other lines are put on hold.

Ending Calls while Someone is on Hold

When  is pressed or handset is closed, all lines are disconnected.

Line 1 Ends while Line 2 is on Hold

A beep sounds. Press  to talk with the other party on hold.

Conference Call

Use up to five lines simultaneously

Press  **Options** while switching between two lines
 → **Select *Multi Party*** → Press  → **Select *Conference All*** → Press 

Ending Calls during Conference Call

When  is pressed or handset is closed, all lines are disconnected.

Some Lines End during Conference Call

Other lines remain connected.

Call Barring

Restrict incoming/outgoing calls, including SMS messages.
Following restrictions are available:

Outgoing Calls	All Outgoing Calls	Restrict all non-emergency calls
	International Calls ¹	Allow only domestic calls
	Only Local & Home ²	Restrict all international calls except to Japan
Incoming Calls	All Incoming Calls	Reject all calls
	Bar if Abroad	Reject calls when outside Japan

¹Example: During a stay in the United Kingdom, only calls within the country are possible.

²Example: During a stay in the United Kingdom, both calls within the country and to Japan are possible.

Restrict dialling or reject incoming calls according to phone numbers, or reject incoming calls without Caller ID.

Fixed Dialling No.	Allow calls only to designated numbers (Currently not available)
Rejected Numbers	Reject calls from designated numbers
Withheld Call	Reject incoming calls without Caller ID

- Note** ▶
- Network Password selected at initial subscription (see **P.1-33**) is required to change Call Barring settings.
 - If Network Password is incorrectly entered three times, Call Barring settings are locked. To resolve, Network Password and Centre Access Code must be changed. For details, contact Vodafone Customer Centre, General Information (see **P.16-32**).
 - **All Outgoing Calls** and **All Incoming Calls** are disabled when Call Forwarding or Voice Mail is active. (Call Forwarding or Voice Mail takes priority.)
 - If **All Outgoing Calls** or **All Incoming Calls** is set while Call Forwarding or Voice Mail is active, Call Barring becomes effective only for service types which are not transferred.

Tip ▶ If call is attempted when Call Barring is active, **Call Barred** appears. It may take longer to appear in some areas. Check Call Barring settings if the message does not appear.

Restricting Outgoing Calls

Set Restriction Restrict outgoing calls by selecting a type of restrictions and services

Main Menu ▶ *Settings* ▶ *Call Settings* ▶ *Call Barring* ▶ *Outgoing Calls*

Select restriction ▶ **Press** ● ▶ **Select a service type** ▶ **Press** ● ▶ **Choose *On*** ▶ **Press** ● ▶ **Enter Network Password** ▶ **Press** ●

Cancel Restriction Cancel restriction of outgoing calls

Main Menu ▶ *Settings* ▶ *Call Settings* ▶ *Call Barring* ▶ *Outgoing Calls*

Each Restriction & Service Type

Select restriction ▶ **Press** ● ▶ **Select a service type** ▶ **Press** ● ▶ **Choose *Off*** ▶ **Press** ● ▶ **Enter Network Password** ▶ **Press** ●

All Restrictions

Select *Cancel All* ▶ **Press** ● ▶ **Enter Network Password** ▶ **Press** ●

Status Check Call Barring status for outgoing calls

Main Menu ▶ *Settings* ▶ *Call Settings* ▶ *Call Barring* ▶ *Outgoing Calls*

Select restriction ▶ **Press** ● ▶ **Select a service type** ▶ **Press** ● ▶ **Select *Status*** ▶ **Press** ●

- Call Barring status appears.

Restricting Incoming Calls

Set/Cancel Restriction

Set or cancel restriction of incoming calls

Main Menu

▶ *Settings* ▶ *Call Settings* ▶ *Call Barring* ▶ *Incoming Calls*

Each Restriction & Service Type

Select restriction ▶ Press ● ▶ Select a service type ▶ Press ● ▶ Choose *On or Off* ▶ Press ● ▶ Enter Network Password ▶ Press ●

All Restrictions

Select *Cancel All* ▶ Press ● ▶ Enter Network Password ▶ Press ●

Rejecting Calls

Rejected Numbers

Reject incoming calls from designated numbers

Default Off

Main Menu

▶ *Settings* ▶ *Call Settings* ▶ *Call Barring* ▶ *Rejected Numbers* ▶ *Switch On/Off*

Choose *On or Off* ▶ Press ●

Set Reject Number

Designate phone numbers to reject

Main Menu

▶ *Settings* ▶ *Call Settings* ▶ *Call Barring* ▶ *Rejected Numbers* ▶ *Set Reject Number*

Adding New Numbers

Select an entry ▶ Press ● ▶ Enter a number ▶ Press ●

- ▶ To save from Phone Book, select an entry ▶ Press ▾ Options ▶ Select *Ph. Book list* ▶ Press ● ▶ Select an entry ▶ Press ● ▶ Select a number ▶ Press ●
- Name appears for numbers saved from Phone Book.

Editing Numbers

Select a number ▶ Press ▾ Options ▶ Select *Edit* ▶ Press ● ▶ Edit a number ▶ Press ●

Deleting Numbers

Select a number ▶ Press ▾ Options ▶ Select *Delete* ▶ Press ● ▶ Press ▾ Yes

Rejecting Calls without Caller ID

Withheld Call

Reject calls without Caller ID

Default Off

Main Menu

▶ *Settings* ▶ *Call Settings* ▶ *Call Barring* ▶ *Withheld Call*

Choose *On or Off* ▶ Press ●

Changing Network Password

Change N/W
Password

Change Network Password

Main Menu

▶ Settings ▶ Call Settings ▶ Call Barring ▶
Change N/W Password

Enter current Network Password ▶ Press ● ▶

Enter new Network Password ▶ Press ● ▶ Enter
new Network Password again ▶ Press ●

Caller ID

Show or hide your own phone number when placing calls. Regardless of this setting, sending or blocking Caller ID can be selected for each call. Enter the following numbers before a phone number when placing a call.

Send	1 8 6 or * 3 1 #
Block	1 8 4 or # 3 1 #

Show Your
Number

Send or block Caller ID

Default On (Send)

Main Menu

▶ Settings ▶ Call Settings ▶ Show Your Number

Choose *On* or *Off* ▶ Press ●

Status

Check Caller ID status

Main Menu

▶ Settings ▶ Call Settings ▶ Show Your Number

Select *Status* ▶ Press ●

- Caller ID status appears.

Vodafone live! Overview

Vodafone live! Basics

Vodafone live! Services

Use Vodafone live! services to exchange text and multimedia messages with compatible handsets, download sounds and images as well as V-applications or browse the Mobile Internet.

■ Web

Use Web to access the Mobile Internet directly from handset. Browse for image or sound files as well as information.

Web Information

Access Vodafone live! compatible Mobile Internet sites from Web Menu.

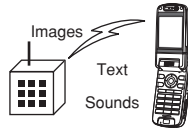

Mobile Internet

Enter Mobile Internet site URLs to visit specific sites or pages directly.



An additional contract is required to use Web service.

■ Messaging

Messaging services are also available outside Japan.

SMS

Exchange short text messages of up to 160 single-byte alphanumeric characters with SMS compatible Vodafone handsets.

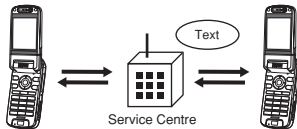

MMS

Exchange long text messages of up to approximately 30,000 single-byte alphanumeric characters with MMS compatible Vodafone handsets, e-mail compatible handsets and PCs and other devices via the Internet. Attach images, sounds or vFiles to send multimedia messages.

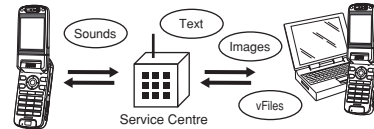

An additional contract is required to use MMS and receive e-mail from PCs, etc.

■ V-applications

Download V-applications, including games and 3D graphics.

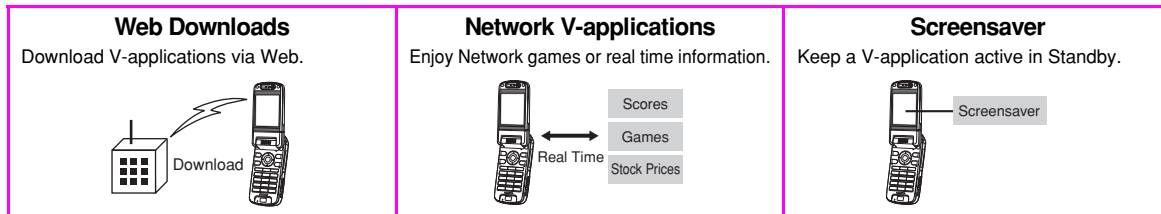

- Download and use 802SH compatible V-applications.
- An additional contract is required to use V-applications.

Tip ► For more details, contact Vodafone Customer Centre, General Information (see **P.16-32**).

Automatic Network Setup

To use Vodafone live! services, first download network connection information from Vodafone live! Service Centre. Handset initiates Network Setup when , or is pressed for the first time. To download network connection information for the second time and after, see "Re-Provisioning" on P.9-18.

1 Press , or

Re-Provisioning *Do you want to get the latest provisioning data and update?* appears.

2 Press **Yes**

Handset connects to the Network and retrieves required information.

- Follow onscreen instructions.

To cancel, press **Cancel**.

(Press , or to initiate Network Setup.)

Customising Handset Address

Default

□□□□□□□□□□@△.vodafone.ne.jp

Custom Account Name ↓ Domain Name

Entered Account Name @ △.vodafone.ne.jp

△ varies by subscription area.
If you have further questions, please contact Vodafone Customer Centre, General Information (see P.16-32).

- Handset must connect to the Network to customise handset address.
- Customising handset mail address helps reduce spam.

Main Menu ▶ Vodafone live!

- 1 Select **My Vodafone** and press
- 2 Select **各種変更手続き** and press
- 3 Select **オリジナルメール設定・各種メール設定/** and press

- Follow onscreen instructions (Japanese only).

For Web basic operations, see P.13-8

Centre Access Code: see P.1-33

Getting Started

Web Info Content

Sample Web information page:

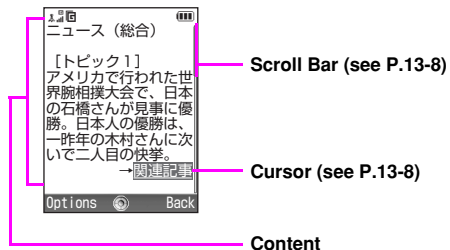

Cache Memory

Web information and Menus are saved temporarily in Cache Memory. When full, oldest items are automatically deleted to make space for new ones.

- Previously opened information may load from Cache Memory.
- Some information has expiry dates and are deleted from Cache Memory upon expiry.

SSL

Secure Sockets Layer (SSL) is an encryption protocol for secure Internet transmissions of important/sensitive information such as credit card numbers.

Electronic certificates are saved on handset (see **P.13-18**).

Disclaimer

When a security notice appears, subscribers must decide for themselves whether or not to open the information. Opening secure information constitutes agreement to the terms of usage. Vodafone, VeriSign Japan, Baltimore Technologies Japan and Entrust Japan cannot be held liable for any damages associated with the use of SSL.

Using Web



Use Web to access the Mobile Internet for information as well as image, sound and other files.

Opening Web Menu

Access Mobile Internet sites by selecting a topic from Vodafone Web Menu. Perform Network Setup before using Web (see P.13-4).

1 Press , select **Vodafone live!** and press

Vodafone Web Menu opens

- Alternatively, press   in Standby to open Vodafone Web Menu.
- Address questions about Vodafone Web to Vodafone Customer Centre, General Information (see P.16-32).
- Vodafone Web Menu content is subject to change.

2 Highlight a menu item

3 Press

- Handset remains connected to the Network even if it is closed.
- To disconnect, press .



4 Repeat Steps 2 - 3 to open additional links

- Basic Operations: see P.13-8

5 Press and then **Yes** to exit

Page Jump

Press  **Back** to open previous page.

- To return to the original page after the above operation, press  **Options** → Select **Forward** → Press 

Opening Secured Information

When accessing SSL/TLS protected information, **Entering secure area. OK?** appears.

Press  **OK** to open information.

-  appears.
- To disable warning messages, see P.13-18.

When Authentication is Required

Information may require authentication for access.

If requested, enter user ID or password → Press 

Tip ► Open information and Web Menus saved in Cache Memory (see P.13-5) without connecting to the Network.

Entering URLs Directly

Enter URLs directly via Web to access Mobile Internet sites. Perform Network Setup before using Web (see **P.13-4**).

Main Menu ► Vodafone live! ► Options (⌂) ► Go to URL

1 Press (⊙)

To enter address prefix (**http://**, etc.), press (⌂) **Options** ► Select **Advanced** ► Press (⊙) ► Select an item ► Press (⊙)

2 Enter URL and press (⊙)

3 Press (⌂) **Options**

4 Select **OK** and press (⊙)

Information appears.

5 Press (⌂) and then (⌂) **Yes** to exit

Note ► Some sites may not be accessed. Images, layouts, etc. may not appear the same as on PCs.

Using URL Log

Access Mobile Internet sites using previously entered URLs.

- Perform Network Setup before using Web (see **P.13-4**).
- Up to 10 domains are saved, and up to 30 information pages are saved under each domain. When Log memory is full, oldest items are deleted to make room for new ones.

Main Menu ► Vodafone live! ► Options (⌂) ► Access History

1 Select a domain folder and press (⊙)

2 Select an item and press (⊙)

To open properties, select an item ► Press (⌂) **Options** ► Select **Details** ► Press (⊙)

■ Press (⌂) **Back** to return.

To send URLs via SMS/MMS, select an item ► Press (⌂) **Options** ► Select **Send Page** ► Press (⊙) ► Create and send message (see **P.14-7 - 14-8**)

3 Press (⌂) and then (⌂) **Yes** to exit

Deleting URL Log

Open Access History and follow these steps.

Select a domain folder or item within (Skip this step for *Delete All*.) ► Press (⌂) **Options** ► Select **Delete** or **Delete All** ► Press (⊙) ► Press (⌂) **Yes**

- **Delete All** clears the entire domain folder when performed for an item inside.

Basic Operations

Moving Cursor

Move cursor to select items. Selectable items are underlined. Use  to scroll through items.

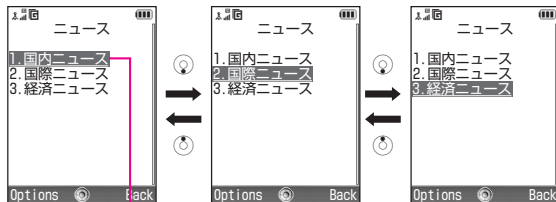

Cursor

Use  to move left and right when multiple items are listed in one row. Cursor does not appear when there are no selectable items.

Scrolling Pages

Scroll bar appears on the right when information continues outside the current window. Red part indicates the current position. Use  to scroll. Red part moves accordingly.

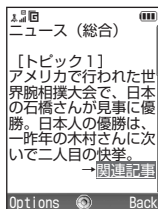

Scroll Bar



Text Entry & Item Selection

Enter text or select items to send information.

Text Entry Field

- Highlight and press . Text entry window opens. Enter text and press .

Check-box

- Highlight (check-box) and press . The box changes to , indicating that the item is selected.
- In addition to , may also appear as selection indicators.

Menu List

- Highlight the field and press  to select an item.

Command Button

- Use to send, reset, etc.
- Highlight and press  to execute the indicated command.

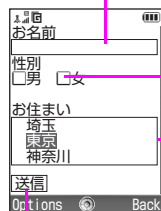

Input Memory

- Entered text is saved to Input Memory, except Security Code and entries made in secured sites. Use saved text in other applications.
- Up to 20 entries are saved. When full, oldest entries are deleted automatically to make room for new ones.

Using Input Memory

In a text entry window, press  **Options** ➔ **Select Advanced** ➔ **Press** ● ➔ **Select Input Memory** ➔ **Press** ● ➔ **Select text** ➔ **Press** ●

Using Linked Info

Use numbers (**TEL:**), addresses or URLs (**http://**, **https://** or **rtsp://**) to place calls, send MMS messages or access Mobile Internet sites.

- Available only when numbers, addresses and URLs are underlined.
- Words may be substituted for the numbers, addresses and URLs.

Main Menu ▶ *Vodafone live!* ➔ *Open information*

- 1** Open information containing a phone number, mail address or URL

2 Phone Numbers

- 1** Select a number and press ●
- 2** Select **Call** or **TV Call** and press ●

The number is dialled.

Mail Addresses

- 1** Highlight an address and press ●

■ Creating a Message: see P.14-7 - 14-8

URLs

- 1** Highlight a URL and press ●

Handset connects to the Network.

- For URLs with **rtsp://**, video or sound is played back (see P.13-14 "Streaming").

Saving to Phone Book

Select a phone number ➔ Press ● ➔ Select **Save to Phone Book** ➔ Press ● ➔ Select **As New Entry** ➔ Press ● ➔ See P.4-3 - 4-5 for more about Phone Book

- To add to existing entry, select a Phone Book entry ➔ Press ● ➔ Press  **Save**

Advanced Features

Saving to Data Folder

Save images, sounds, vFiles, etc. to Data Folder.

Files in Information

Main Menu ▶ Vodafone live! ▶ Open information ▶ Options
(⏏)

1 Select **Save Items** and press ●

Available files are listed.

- To open files, select a file ▶ Press ⏏ Options ▶ Select **View** ▶ Press ●
 - Press ⏏ Back to return.
- To open properties, select a file ▶ Press ⏏ Options ▶ Select **Details** ▶ Press ●
 - Press ⏏ Back to return.
- To send files via MMS, select a file ▶ Press ⏏ Options ▶ Select **Send** ▶ Press ● ▶ Create and send message (see P.14-7 - 14-8)

2 Select a file and press ●

Data Folder opens.

- To switch to SD Memory Card, press ⏏.
- To save to a sub folder, select folder ▶ Press ●

3 Select **Save here** and press ●

4 Enter title (file name) and press ●

- To accept the default title (file name), press ⏏ OK.

5 Press ⏏ OK

File is saved to Data Folder.

- When memory is full, notification appears. Delete files and try again (see P.8-14).

Linked Files

In some pages, files may be downloaded from links.

Main Menu ► Vodafone live! ► Open information

1 Select a link and press ●

File details appear.

2 Press ●

Download starts. A confirmation appears after download, and file is saved to Data Folder.

To cancel, press  **Cancel**.

3 Press ●

The content plays or appears.

Press  **Back** to return.

Bookmarks & My Saved Page

Save frequently used information/URLs to Bookmarks or My Saved Pages.

Function	Description	Folder
Bookmarks	Save links to Mobile Internet sites. Handset connects to the Network to access the site.	Available
My Saved Page	Save Mobile Internet site content. Handset does not connect to the Network to open saved information.	N/A

- Sharp's **Space Town** Mobile Internet site (Japanese Only) is Bookmarked by default. Visit **Space Town** for various downloads such as Wallpapers, games and Dictionary files.
- Save frequently used information to My Saved Page.

Saving URLs & Information

Main Menu ▶ Vodafone live! ▶ *Open information*

1 Press **Options**

- Information can only be saved when *Mark Page* appears in Menu.

2 Bookmarks





1 Select *Mark Page* and press

2 Press

3 Enter title and press

4 Press **OK**

5 Press

- If the same title exists, press  → Change title → Press  → Press  **OK** → Press 

My Saved Page

1 Select *Advanced* and press

- Information can only be saved when *Save This Page* appears in Menu.











2 Select *Save This Page* and press

3 Enter title and press

4 Press **OK**

Saving URLs to Bookmarks

Enter URLs and save to Bookmarks.

Press  **Options** → Select *Bookmarks* → Press 
 → Press  **Options** → Select *New* → Press 
 Select *Bookmark* → Press  twice → Enter URL →
 Press  → Press  **Options** → Select *OK* → Press
 → Enter title → Press  → Press  **OK** →
 Press 





Opening Saved Info & Links

Main Menu ▶ Vodafone live!

1 Press **Options**

2 Bookmarks

1 Select *Bookmarks* and press

- To open properties, select a file → Press  **Options** → Select *Details* → Press 
 - Press  **Back** to return.
- To send URL via MMS/SMS, select a title → Press  **Options** → Select *Send Page* → Press  → Create and send message (see P.14-7 - 14-8)









Bookmarks

My Saved Page

1 Select *Advanced* and press

2 Select *My Saved Page* and press

- To update items, press  **Options** → Select *Update* → Press 
- To open properties, select a title → Press  **Options** → Select *Details* → Press 
 - Press  **Back** to return.
- To show or hide date, select a title → Press  **Options** → Select *Show Date/Hide Date* → Press 



My Saved Page





3 Select a title and press

Editing Bookmarks & My Saved Page

Open Bookmarks or My Saved Page first (see P.13-12 "Opening Saved Info & Links").

Rename

Edit title or Bookmarks folder name

Select a title or folder → Press  **Options** → Select **Rename** → Press  twice → Enter title → Press 
→ Press  **OK**

Delete

Delete entries

Select a title or folder → Press  **Options** → Select **Delete** or **Delete All** → Press  → Press  **Yes**

- Before deleting a folder, delete all the titles in the folder.

Edit URL (only for Bookmarks)

Edit URLs in Bookmarks

Select a title → Press  **Options** → Select **Edit URL**
→ Press  twice → Enter URL → Press  → Press  **Options** → Select **OK** → Press 

Bookmarks Folder

Sort Bookmarks into folders

Create a Folder

Open Bookmarks and press  **Options** → Select **New**
→ Press  → Select **Folder** → Press  twice →
Enter a name → Press  → Press  **OK**

Move to Folder

Open Bookmarks and select a title → Press  **Options** →
Select **Move** → Press  → Select a folder → Press 

- **Move** can only be selected when there is a folder.

Streaming

Play back a video or sound file while it is downloading.

- Only compatible files are supported.
- Downloaded files are not saved.

Main Menu ▶ Media Player ▶ Open Playlist ▶ Options (⌂)

1 Select *Streaming* and press (⊙)

2 *Entering URLs*

1 Select *Enter URL* and press (⊙)

2 Enter a URL

- Enter up to 1024 alphanumeric.

Connecting from Favourites

1 Select *Favourites* and press (⊙)

2 Select a title

Connecting from Access Log

1 Select *Access Log* and press (⊙)

2 Select an item

3 Press (⊙)

Media Player plays back video or sound.

■ Playing Music: see P.7-3

■ Playing Video: see P.7-6

When Manner Mode is Active

Manner mode active. Output sound? appears.

- Press (⏏) **Yes** to cancel Manner mode temporarily. Handset speaker outputs sound at the volume set for Media Player.
- Press (⏏) **No** to stay in Manner mode. Enjoy sound discretely with Multi Stereo Headphones, etc.

Changing Display Size

After Step 1, select *Display Size* ▶ Press (⊙) ▶

Select *Original Size* or *Enlarge* ▶ Press (⊙)

Favourites

■ To save the source URL to My Saved Page, pause playback and follow these steps.

Press (⏏) **Options** ▶ Select *Favourites* ▶ Press (⊙)

▶ Select *Add Current* ▶ Press (⊙)

- Save up to 99 titles.

■ To edit titles, perform Step 1 and follow these steps.

Select *Favourites* ▶ Press (⊙) ▶ Select an item ▶

Press (⏏) **Options** ▶ Select *Edit Name* ▶ Press (⊙) ▶

Enter a title ▶ Press (⊙)

- Enter up to 128 characters.

■ To delete titles, perform Step 1 and follow these steps.

Select *Favourites* ▶ Press (⊙) ▶ Select an item ▶

Press (⏏) **Options** ▶ Select *Delete* ▶ Press (⊙) ▶

Press (⏏) **Yes**

Access Log

- Up to 10 previously accessed URLs are saved. When full, oldest URLs are deleted automatically to make room for new ones.
- To open properties, perform Step 1 on P.13-14 and follow these steps.
 - **Select Access Log** ➔ **Press** ● ➔ **Select a URL** ➔ **Press** ⏏ **Options** ➔ **Select Detail** ➔ **Press** ●
 - Press ⏏ **Back** to return.
 - To edit and access URLs, perform Step 1 on P.13-14 and follow these steps.
 - **Select Access Log** ➔ **Press** ● ➔ **Select a URL** ➔ **Press** ⏏ **Options** ➔ **Select Edit URL** ➔ **Press** ● ➔ **Edit URL** ➔ **Press** ●
 - To delete URLs, perform Step 1 on P.13-14 and follow these steps.
 - **Select Access Log** ➔ **Press** ● ➔ **Press** ⏏ **Options** ➔ **Select Delete All** ➔ **Press** ● ➔ **Press** ⏏ **Yes**

Note ➔ Handset remains connected to the Network while Streaming.

Sub Menu Settings

Reload Page Update information

Main Menu ▶ *Vodafone live!* ➔ *Open information* ➔ *Options*
(⏏)

Select Reload Page ➔ **Press** ●

Send Page Send URLs via SMS/MMS

Main Menu ▶ *Vodafone live!* ➔ *Open information* ➔ *Options*
(⏏) ➔ *Advanced* ➔ *Send Page*

Create and send message (see P.14-7 - 14-8)

Properties Open information details

Main Menu ▶ *Vodafone live!* ➔ *Open information* ➔ *Options*
(⏏) ➔ *Advanced*

Select Details ➔ **Press** ●

Press ⏏ **Back** to return.

Browser Data Clear Cache, Cookies or Access History

Main Menu ► Vodafone live! ► *Open information* ► *Options*
(Ⓜ) ► *Advanced* ► *Browser Data*

Select an item ► Press ●

Search This Page Search within information, or jump to the top or end of information

Main Menu ► Vodafone live! ► *Open information* ► *Options*
(Ⓜ) ► *Advanced* ► *Search This Page*

Text Search

Select **Search** ► Press ● ► Enter text to search ►
Press ● ► Press Ⓜ **Go**

- Only the first text is highlighted if more than one is found.

Jump to Top or End of Information

Select **Jump to Top** or **Jump to Bottom** ► Press ●

Restart Browser Close browser and start it again

Main Menu ► Vodafone live! ► *Open information* ► *Options*
(Ⓜ) ► *Advanced*

Select **Restart Browser** ► Press ●

About Open browser details

Main Menu ► Vodafone live! ► *Open information* ► *Options*
(Ⓜ) ► *Advanced*

Select **About** ► Press ●

Press Ⓜ **Back** to return.

Uploading Files Upload images or other files in Data Folder to the Centre via Mobile Internet sites

Main Menu ► Vodafone live! ► *Open information*

Open a site and select **Browse...** ► Press ● ► **Data Folder opens** ► Select a file (see P.8-4) ► Press ●
► Select **Send** ► Press ●

- Example above is for reference only. Follow site instructions for specific procedure.
- Some files may not be uploadable.

Other Functions

Basic Settings

Cookies

Enable or disable cookies

Default: Enabled

Main Menu

▶ Vodafone live! ▶ Options (☰) ▶ Advanced ▶ Settings ▶ Cookies

Select **Enabled or Disabled** ▶ Press ●

- A cookie is a piece of information sent by a server for user identification.

Downloads

Select whether to download images and sounds on Mobile Internet sites automatically or to open text information only

Default: Downloaded (all)

Main Menu

▶ Vodafone live! ▶ Options (☰) ▶ Advanced ▶ Settings ▶ Downloads

Select **Images, Sounds or Objects** ▶ Press ● ▶
Select **Show images/Play sounds/Download objects**
or **Don't show images/Don't play sounds/Don't download objects** ▶ Press ●

IMEI Notification

Information may require user ID
Select whether or not to send user ID upon request

Default: Off

Main Menu

▶ Vodafone live! ▶ Options (☰) ▶ Advanced ▶ Settings ▶ IMEI Notification

Choose **On or Off** ▶ Press ●

Scroll Step

Select from three scroll units

Default: Single Line

Main Menu

▶ Vodafone live! ▶ Options (☰) ▶ Advanced ▶ Settings ▶ Scroll Step

Select a unit ▶ Press ●

Font Size

Change character size

Default: Medium

Main Menu

▶ Vodafone live! ▶ Options (☰) ▶ Advanced ▶ Settings ▶ Font Size

Select size ▶ Press ●

Download to

Select a destination of downloaded files

Default: Memory Card Pref.

Main Menu

▶ Vodafone live! ▶ Options (☰) ▶ Advanced ▶ Settings ▶ Download to

Select **Handset Memory or Memory Card Pref.** ▶ Press ●

- Even when **Memory Card Pref.**, downloaded files are saved to handset if SD Memory Card is not inserted. (Also, some files may not be saved to SD Memory Card.)

In addition, choose whether or not to send location info automatically. When **Datum On/Off** in **LBS Settings** (see **P.10-13**) is set to **Off**, location info is not sent.

Security

Secure Prompt

Select whether to show or hide warning messages before entering and exiting SSL/TLS secured information

Default: Show

Main Menu

Vodafone live! → Options (☰) → Advanced → Settings → Security → Secure Prompt

Select **Show** or **Don't Show** → Press ●

Certificates

View certification of currently opened information

Main Menu

Vodafone live! → Options (☰) → Advanced → Settings → Security

Select **Certificates** → Press ●

Press ☐ **Back** to return.

Root Certificates

Open electronic certificates issued by Certificate Authorities saved on handset

Main Menu

Vodafone live! → Options (☰) → Advanced → Settings → Security → Root Certificates

Select a **certificate** → Press ●

Press ☐ **Back** to return.

Authentication

Previously entered user ID or password is entered automatically for authentication

Default: On

Main Menu

Vodafone live! → Options (☰) → Advanced → Settings → Security → Authentication

Choose **On** or **Off** → Press ●



Messaging

Incoming Text Messages

The Centre automatically delivers text messages to handset.

Opening New Messages

1 When mail arrives, animation plays and Delivery Notice appears

 (SMS Mail) or  (MMS Mail) appears according to message type.



- When handset is closed (clamshell closed), open handset (clamshell open) to see Delivery Notice.



Delivery Notice

2 Press

Received folder opens (see P.14-19).

- When messages are automatically sorted to Personal Folders, select a folder  Press 

3 Select a message and press

Message window opens (see P.14-3 "Message Content").

- To download the entire MMS message, see P.14-4.

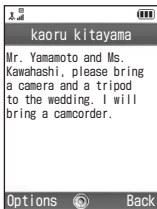

Message Window

4 Press and then press

 **Yes** to exit

Information

Number of unread messages appears in Standby.

To open messages, select an item  Press  

Perform from Step 3

New Mail during Operations

Information appears when Standby returns.

Tip  See P.14-17 to open Received folder when Delivery Notice does not appear.

In Viewer Position

Use Side Keys to open new messages in Viewer position.

1 When mail arrives, animation plays and Delivery Notice appears

☞ (SMS Mail) or ☞ (MMS Mail) appears according to message type.

2 Press Ⓞ

Received folder opens (see P.14-19).

■ When messages are automatically sorted to Personal Folders, select a folder ➔ Press Ⓞ

3 Use ⏪ or ⏩ to select a message and press Ⓞ

Message window opens.

4 Press Ⓞ to exit

Received folder returns.

■ Press Ⓞ to return to Standby.

Message Content

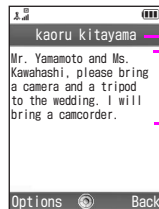

Sender

- Number, mail address or name appears.
- If the number or mail address is not saved in Phone Book, name designated by the sender appears except for the following:
 - MMS Notice
 - MMS messages not saved on the Server

Message Text

Retrieving MMS Messages

The Centre delivers the initial portion of MMS messages when:

- A message was sent to multiple recipients
- Files are attached to the message
- In Received folder, **M** appears when the remaining portion of MMS message (MMS Notice) is held at the Centre.
- Alternatively, download MMS messages using Mail List (see **P.14-30**).

Retrieving a Message

Main Menu ► Messages ► Received

1 Select a message and press  **Options**

- Select a message with **M**.

2 Select **Download** and press 

Download starts.

- After the message is retrieved, Received folder returns.

Note ► Messages up to 300 KB can be received.

Tip ► Limit the size of incoming messages (see **P.14-33**).

Retrieving Selected Messages

When more than one message is selected, some may not be retrieved.

Main Menu ► Messages ► Received ► Options (⌂)

- 1 Select **Advanced** and press ●
- 2 Select **Multiple Select** and press ●
- 3 Select a message and press ●
 - ✓ appears on the right of the selected message.
 - Select a message with **■**.
 - To uncheck, select a message with ✓ ► Press ●
- 4 Repeat Step 3 to select all messages to retrieve
 - To select all, press ⌂ **Options** ► Select **Select All** ► Press ●
 - To uncheck all, ⌂ **Options** ► Select **Unselect All** ► Press ●
- 5 Press ⌂ **Options**
- 6 Select **Download** and press ●

Download starts.

 - After messages are retrieved, Received folder opens.
 - To cancel download, press ⌂ **Cancel** ► Press ⌂ **Yes**

Using Received Messages

Reply Reply to messages

Open a message and press ⌂ **Options** ► Select **Reply** or **Reply all** ► Press ● ► Perform from Step 4 in "Replying to Messages" on P.14-23

- For MMS messages, subject is automatically entered prefaced with **Re:**.
- Use MMS to send messages to up to 20 recipients at once.
- Select **Reply All** to send the same message to all recipients (To/Cc). **Reply All** may not appear for some messages.

Forward Forward messages

Open a message and press ⌂ **Options** ► Select **Forward** ► Press ● ► Perform from Step 5 in "Forwarding Messages" on P.14-23

- For MMS messages, subject is automatically entered prefaced with **Fw:**.
- For MMS Notice, Server Mail is transferred (see P.14-31).

Call Call sender directly from messages received from Vodafone handsets

Open a message and press ⌂ **Options** ► Select **Call Contacts** ► Press ●

Sending Text Messages

Overview

Compose Message (see P.14-8)



Attach Files (MMS Mail: see P.14-9)

Image

Sound

Video

vFile

Other File



Enter Recipient (see P.14-12)

Phone Book

Direct Entry



Enter Subject (MMS Mail: see P.14-13)



Send Message

Character Entry Limits

Character limits vary by Message Type.

SMS Mail	160 single-byte alphanumerics
MMS Mail	Approximately 30,000 single-byte alphanumerics, up to 300 KB including attachments



MMS message text character limit differs by attachment size and number of recipients.



Available Entry Items

Available entry items vary by Message Type.

	Message	Attachments	Recipient	Subject
SMS Mail	Valid	N/A	Valid	N/A
MMS Mail	Valid	Valid	Valid	Valid

Media Console

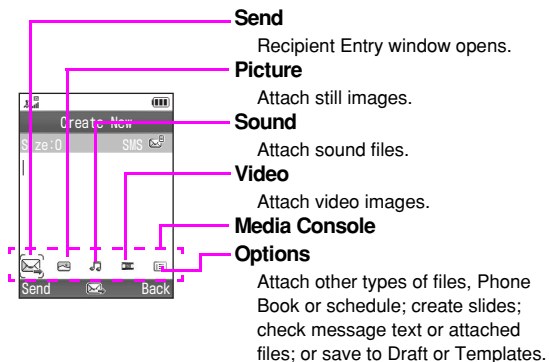

Media Console appears in New Message window for mail-related functions. When  is on Media Console, use  to select icons.

Otherwise press  until  appears or press  **Options** to use the functions.



Creating a Message

1 Press , select **Messages** and press

- Alternatively, press   in Standby.

2 Select **Create New** and press

New Message window opens.

3 Enter message text and attach files

4 Press until appears on **Media Console**

- Skip this step if it is already on Display.

5 Use to select **Send** on **Media Console** and press

Recipient Entry window opens.



New Message Window

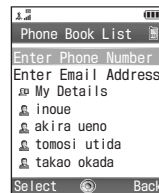



Recipient Entry Window

6 Enter a recipient and press

Mail Setting window opens.

7 Enter subject or specify Advanced settings, if necessary

 To return to New Message window, press  **Back**.

 Advanced Settings: see P.14-14

 Saving to Draft: see P.14-15

 Saving as Template: see P.14-16

8 Select **Send Message** and press

 To cancel, open Unsent folder (see Step 1 on P.14-17) \rightarrow Select a message \rightarrow Press  **Options** \rightarrow Select **Cancel** \rightarrow Press 

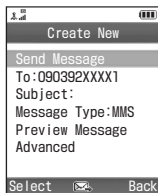

Mail Setting Window

Incoming Calls during Message Creation

New Message window returns after call ends.

Preview Message

To check messages before sending, select **Preview Message** in Mail Setting window \rightarrow Press 

 Press  **Back** to return.

When Recipient Handset is Off or Out-of-Range

Messages are saved at the Centre, and delivered when recipient handset connects to the Network.

-  To set the storage period, see P.14-14 "Expiry Time". Message is deleted if not received by the set Expiry Time.

- Tip** \blacktriangleright
- Messages are sent even if handset is closed.
 - When send fails, messages are saved to Unsent folder ( appears).



Entering Message Text

Main Menu \blacktriangleright Messages

1 Select **Create New** and press

New Message window opens.

2 Enter a message

Press Keypad ( -  or ) for the first character of the message text to open text entry window.



 Entry Modes: see P.3-2



 Character Entry Limits: see P.14-6



New Message Window

3 Press

 To edit the message, select the text entry field \rightarrow Press  \rightarrow Edit \rightarrow Press 

 To open Recipient Entry window, select  **Send** on Media Console \rightarrow Press  \rightarrow Perform from Step 2 on P.14-12

Inserting Signature

In a text entry window, press **Options** ➔ **Select Advanced** ➔ **Press** ➔ **Select Signature** ➔ **Press**

- Create signature beforehand (see P.14-31).

Changing Font Colour

In a text entry window, press **Options** ➔ **Select Advanced** ➔ **Press** ➔ **Select Font Colour** ➔ **Press** ➔ **Select a colour** ➔ **Press**

- Selected colour is applied to the entire text.

- Tip** ▶
- Estimated message size appears in New Message window.
 - For MMS messages, mail addresses count towards the character limit.

Attaching Images & Sounds

Attach images, sound files or vFiles.

- Attach up to 300 KB including message text.
- To switch to SD Memory Card, press in file list for Data Folder (see Step 1 in "Opening Files" on P.8-4).

Main Menu ▶ *Messages* ➔ *Create New*

1 Enter text and press

- Files can be attached without entering text.

2 Press until appears on Media Console

- Skip this step if it is already on Display.

3 *Attaching Images*

1 Use to select (**Picture**) and press

2 Select **Saved Pictures** and press

- To capture images, select **Take Picture** ➔ Press ➔ Press (Shoot) ➔ Press **Save** ➔ Proceed to Step 4

3 Select an image and press

- For large JPEG images, select a size ➔ Press

Attaching Sound Files

1 Use to select (**Sound**) and press

2 Select **Saved Sounds** and press

- To record sound, select **Record Sound** ➔ Press ➔ Press (Start) ➔ Press (Stop) ➔ Select **Save and Send** ➔ Press ➔ Select **Handset Memory** or **Memory Card** ➔ Press ➔ Proceed to Step 4

3 Select a file and press

Attaching Video Images

1 Use to select (Video) and press

2 Select *Saved Videos* and press

- To capture a video image, select *Record Video* → Press → Press (Start) → Press (Stop) → Select *Save and Send* → Press → Select *To Handset Memory* or *To Memory Card* → Press → Proceed to Step 4

3 Select a file and press

Attaching Phone Book

1 Use to select **Options** and press

2 Select *Attach Ph. Book* and press

3 Select an entry and press

- ⓘ appears next to the size indication.
- Attached Phone Book entries are saved to Data Folder (Other Documents).

Attaching Other Files

1 Use to select **Options** and press

2 Select *Attach File* and press

3 Select a folder and press

4 Select a file and press

- ⓘ appears next to the size indication.

4 When finished, press until appears

- Skip this step if it is already on Display.

5 Use to select **Send** and press

- Entering Recipient: see P.14-12
- Saving to Draft: see P.14-15
- Saving as Template: see P.14-16

Attaching Schedule

In New Message window, select **Options** on Media Console → Press → Select *Attach Appt.* → Press → Select a day with schedules → Press → Select an entry → Press

Replacing Attachments

In New Message window, select a file → Press **Options** → Select *Replace Picture, Replace Sound or Replace Video* → Press → Select a file → Press

Deleting Attachments

In New Message window, select a file → Press **Options** → Select *Remove Picture, Remove Sound or Remove Video* → Press

- To delete message text, select the text entry field → Press **Options** → Select *Remove Text* → Press

Playing Sound Files/Video Images

In New Message window, select a file → Press **Options** → Select *Play* → Press

Preview Message

In New Message window, select **Options** on Media Console ➔ Press **Enter** ➔ Select **Preview Message** ➔ Press **Enter**

- Press **Back** to return.

Checking Attachments

In New Message window (with **Attachments**), follow these steps:

Select **Options** on Media Console ➔ Press **Enter** ➔ Select **View Attachments** ➔ Press **Enter** (Attachment list appears.)

- To open an attachment, select a file after the above operation ➔ Press **Enter**
- To delete an attachment, select a file after the above operation ➔ Press **Options** ➔ Select **Delete** ➔ Press **Enter**
- To delete all attachments, press **Options** after the above operation ➔ Select **Delete All** ➔ Press **Enter** ➔ Press **Yes**

Note

Confirm compatibility with recipient handsets (file format, services, etc.) before sending files.

Creating Slides

Combine message text with sounds or still/video images to create slides. Received slides appear in order.

Attach up to two files to create a slide. (Select a still image file and a sound file to attach two.)

Main Menu ► Messages ► Create New

- 1 Enter text, press **Enter** and attach a file
- 2 Press **Options** until **Attachments** appears on Media Console
 - Skip this step if it is already on Display.
- 3 Use **Left Arrow** to select **Options** and press **Enter**
- 4 Select **Add Slide** and press **Enter**
- 5 Select **Add Slide Before** or **Add Slide After** and press **Enter**
 - For **Add Slide After**, the first slide will be text/file entered/attached in Step 1.
- 6 Create next slide
 - Repeat Steps 2 - 6 to create additional slides.

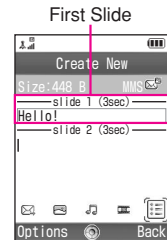

7 When finished, press until appears on Media Console

- Skip this step if it is already on Display.

8 Use to select **Send** and press

- Entering Recipient: see right
- Saving to Draft: see P.14-15
- Saving as Template: see P.14-16

Adding Slides

In New Message window, select the place to insert a new slide → Press **Options** → Select *Add Slide* → Press → Select *Add Slide Before* or *Add Slide After* → Press

Deleting Slides

In New Message window, select a slide → Press **Options** → Select *Remove Slide* → Press

- The last slide returns to a normal text message.

Slide Duration

Set display time for each slide.

In New Message window, select a slide → Press **Options** → Select *Slide Duration* → Press → Select time → Press

- When *Custom Time* is selected, enter time → Press

Entering Recipient

Main Menu ► *Messages* ► *Create New* ► *Enter text and others*

1 Press until appears on Media Console

- Skip this step if it is already on Display.

2 Use to select **Send** and press

Recipient Entry window opens.

3 *Phone Book*

- 1 Select an entry and press
- 2 Select recipient's mail address or Vodafone handset number

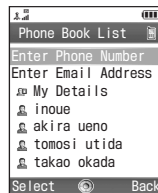

Recipient Entry Window

Direct Entry

- 1 Select *Enter Phone Number* or *Enter Email Address* and press
- 2 Enter recipient's Vodafone handset number or mail address

4 Press

Mail Setting window opens.

- Entering Subject: see P.14-13
- Setting Message Type: see P.14-14
- Advanced Settings: see P.14-14
- Creating a Message: see P.14-7 - 14-8
- Saving to Draft: see P.14-15
- Saving as Template: see P.14-16

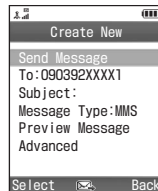

Mail Setting Window

Adding Recipients

- Enter up to 20 recipients.

In Mail Setting window, select the recipient entry field ➔ Press **⓪** ➔ Address List appears ➔ Select *Add Ph. Book* ➔ Press **⓪** ➔ Enter or select a number or address (see P.14-12) ➔ Press **⓪**

- Press **⏪** **Back** to return to Mail Setting window.

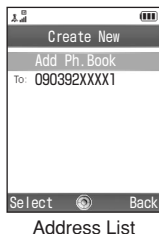

Recipient Type (To, Cc & Bcc)

- To edit, open Address List and follow these steps:
Select a number or address ➔ Press **⏪** **Options** ➔ Select *Change to TO*, *Change to CC* or *Change to BCC* ➔ Press **⓪**
 - Recipients cannot see numbers/addresses set to Bcc.

Editing Text/Attachments from Mail Setting Window

- In Mail Setting window, press **⏪** **Back** to open New Message window.
 - To edit text, select the text entry field ➔ Press **⓪** ➔ Edit ➔ Press **⓪**
 - To replace/delete attachments in New Message window, see "Replacing Attachments" and "Deleting Attachments" on P.14-10.

Editing Recipients

In Address List, select a number or address ➔ Press **⏪** **Options** ➔ Select *Edit Recipients* ➔ Press **⓪** ➔ Edit a number or address ➔ Press **⓪**

Deleting Recipients

In Address List, select a number or address ➔ Press **⏪** **Options** ➔ Select *Remove* ➔ Press **⓪**

Sending from Phone Book Entries

- Open a Phone Book entry and follow these steps:
 - Phone Numbers
Select a number ➔ Press **⓪** ➔ Select *Create Message* ➔ Press **⓪** ➔ Create a message (see P.14-7 - 14-8)
 - Mail Addresses
Select a mail address ➔ Press **⓪** ➔ Create a message (see P.14-7 - 14-8)

Tip ➤ When a mail address is entered, do not use single-byte katakana or Pictographs in message text and subject. They may not appear properly on recipient devices.

Entering Subject

- Subject field is only available for MMS messages.
- Enter a subject in Mail Setting window (see Step 4 on P.14-12).

1 In Mail Setting window, select the subject entry field and press **⓪**

- Enter up to 40 single-byte alphanumerics (13 single-byte katakana or double-byte characters).

2 Enter subject and press **⓪**

Setting Message Type

- Set a message type (SMS or MMS) in Mail Setting window (see Step 4 on **P.14-12**).
- SMS is not available when:
 - Subject is entered
 - Files are attached
 - Sending to mail addresses
 - Recipient's phone number is over 20 digits
 - Text exceeds 160 single-byte alphanumerics
 - Font Colour is not **Black**
 - Priority in Advanced settings is not **Normal**
 - Delivery Time in Advanced settings is not **No delay**
- Message Type is set to **Automatic** by default.

1 In Mail Setting window, select **Message Type** and press

2 Select **Automatic**, **SMS** or **MMS** and press

- **Downgrading to selected message type is not allowed.** appears when SMS is not available.

Advanced Settings

- These settings are valid for one message when set during message composition.
- Advanced settings are not available when resending messages.
- Specify settings in Mail Setting window (see Step 4 on **P.14-12**).

Delivery Report

Request a Delivery Report (see **P.14-20**) to confirm message delivery

Default Off

In Mail Setting window, select **Advanced** ➔ Press
 ➔ Select **Delivery Report** ➔ Press ➔ Choose **On**
 or **Off** ➔ Press

Expiry Time

Set a time limit to store sent messages at the Centre

Default Maximum

In Mail Setting window, select **Advanced** ➔ Press
 ➔ Select **Expiry Time** ➔ Press ➔ Select a limit ➔
 Press

Priority

Set delivery priority when sending mail

■ Available only for MMS messages.
Default Off

- In Mail Setting window, select **Advanced** ➔ Press **⊙**
➔ Select **Priority** ➔ Press **⊙** ➔ Select from **Low** to **High** ➔ Press **⊙**
- Priority does not affect delivery speed.

Delivery Time

Set time delay for message delivery

■ Available only for MMS messages.
Default No delay

- In Mail Setting window, select **Advanced** ➔ Press **⊙**
➔ Select **Delivery Time** ➔ Press **⊙** ➔ Select a time
➔ Press **⊙**

Saving to Draft

Main Menu ▶ Messages ➔ Create New

1 Enter text and press **⊙**

Creating a Message: see P.14-7

2 New Message Window

1 Press **⊙** until **⏏** appears on Media Console

• Skip this step if it is already on Display.

2 Use **⊙** to select **Options** and press **⊙**

Mail Setting Window

1 Select the recipient entry field and press

⏏ **Options**

3 Select **Save to Drafts** and press **⊙**

The message is saved to Draft folder.

• When memory is low, original window returns. Delete messages and try again (see P.14-25).

4 Press **⏏** and then **⏏** **Yes** to exit

Note ▶ The order in which addresses (**To**, **Cc** and **Bcc**) or attachments appear may change when saving MMS messages.

Using Mail Templates

Save created messages as templates.

Saving as Template

Main Menu ► Messages ► Create New

1 Enter text and press

Creating a Message: see P.14-7

2 New Message Window

1 Press until appears on Media Console

- Skip this step if it is already on Display.

2 Use to select **Options** and press

Mail Setting Window

1 Select the recipient entry field and press

Options

3 Select *Save as Template* and press

4 Enter name and press

5 Press **Options**

6 Select *Save* and press

Creating Message from Template

Main Menu ► Messages

1 Select *Templates* and press

Template list appears.

2 Select a template and press

New Message window opens.

3 Edit the template message

Creating a Message: see P.14-7

Protecting/Unprotecting Templates

After Step 1, select a template ► Press **Options**

► Select *Lock* or *Unlock* ► Press

Opening Properties

After Step 1, select a template ► Press **Options**

► Select *Message Details* ► Press

- Press **Back** to return.

Deleting Templates

After Step 1, select a template (Skip this step when deleting all) ► Press **Options** ► Select *Delete* or

Delete All ► Press ► Press **Yes**

Mail Box

Mail Box Type

Messages are organised in separate folders according to the type.

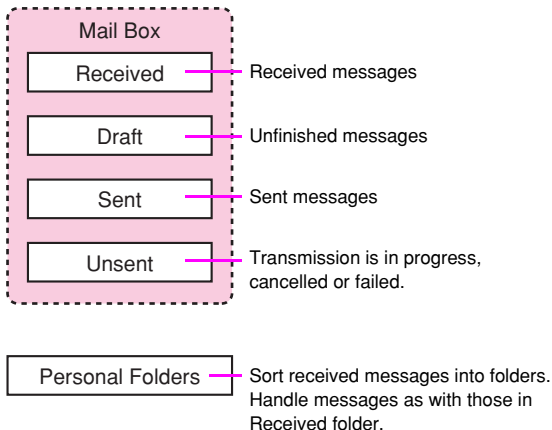

Checking Messages

Messages in Mail Box

Main Menu ▶ Messages

1 Select *Received*, *Draft*, *Sent* or *Unsent* and press **⊙**

Message list appears (see P.14-19).

2 Select a message and press **⊙**

Message window opens (see P.14-20 "Message Content").

- If attached image is too large, it may not appear.
 - Attached slide appears automatically.
 - For *Draft*, New Message window opens (see P.14-7).
- Use **⏮** to scroll.

3 Press **⏮** and then **⏪** **Yes** to exit

Note ▶ Messages in *Draft*, *Sent* or *Unsent* may not open if attached files are deleted from Data Folder.

Resending Messages

■ To resend failed messages, open Unsent folder and follow these steps.

Select a message → Press  **Options** → **Select Re-send** → Press 

Editing Messages

Open Draft folder and select a message → Press 
→ **Edit the message**

Open Unsent folder and select a message → Press  **Options** → **Select Edit** → Press  → **Edit the message**

Tip ▶ Press  -  to activate Display Backlight.

Messages in Personal Folders

See P.14-20 for details about Personal Folders.

Main Menu ▶ *Messages* ▶ *Personal Folders*

1 Select a folder and press

Message list appears (see P.14-19).

2 Select a message and press

Message window opens (see P.14-20 "Message Content").

- The succeeding steps are the same as those for Mail Box.



Message Type or Status

• Message Status

	Unread		Read		Sent		Failed
--	--------	--	------	--	------	--	--------

• Message Type or Settings

	MMS Mail ¹		SMS Mail		File attached		Protected		Priority (High)
	Priority (Low)		MMS Notice ²		Delivery Report ³		SMS Mail on USIM Card		

¹Appears only when MMS Mail is subscribed.

²Appears only in Received folder.

³Appears only in Sent folder.

Sender or Recipient

- Number, mail address or name appears.
- If the number or mail address is not saved in Phone Book, name designated by the sender appears except for the following:
 - MMS Notice
 - MMS messages not saved on the Server

Received or Sent Date & Time

Subject or Message Text

Subject (MMS Mail) or message text (SMS Mail) appears.

Message Content

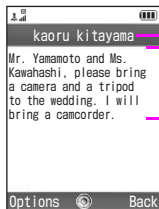

Sender or Recipient

- Number, mail address or name appears.
- If the number or address is not saved in Phone Book, name designated by the sender appears except for the following:
 - MMS Notice
 - MMS messages not saved on the Server

Message Text

Confirming Report

- Set **Delivery Report** (see P.14-14, P.14-31) to **On** and send messages to receive Delivery Report from the Centre.

Delivery Report arrives → **Delivery Notice appears**

→ Press **⊙** (Received folder opens) → **Select a message** → Press **⊙**

- Press **⏪** **Back** to return.

Personal Folders

Sort received messages into seven Personal Folders.

Changing Folder Name

Main Menu ▶ *Messages* ▶ *Personal Folders*

1 Select a folder and press **⏪** **Options**

2 Select **Rename** and press **⊙**

3 Press **⊙**

4 Enter name and press **⊙**

- Enter up to 100 single-byte alphanumeric (33 single-byte katakana or double-byte characters).

5 Press **⏪** **OK**

Moving Messages

- Incoming linked messages cannot be moved.
- Move messages between folders in Personal Folders.

Main Menu ▶ Messages

1 Select *Received* or *Personal Folders* and press ●

Message list appears (see P.14-19).

For *Personal Folders*, select a folder ▶ Press ●

2 Select a message and press > Options

3 Select *Advanced* and press ●

4 Select *Move to Folder* and press ●

5 Select a folder and press ●

6 Press ⏪ to exit

Auto Sort

Sort messages automatically by phone number, mail address or subject.

- Create up to 5 Distribution Rules for one folder.
- Distribution Rule with a smaller number has higher priority.

Main Menu ▶ Messages ▶ Settings

- 1 Select *Personal Folders* and press ●
- 2 Select a folder and press ●
- 3 Select a number and press ●
- 4 *Sorting by Phone Number/Address*
 - 1 Select *Address* and press ●
 - 2 Enter a number or address and press ●
 - Entering Recipient: see P.14-12
- Sorting by Subject*
 - 1 Select *Subject* and press ●
 - 2 Enter text and press ●
 - Enter up to 40 single-byte alphanumerics (13 single-byte katakana or double-byte characters).
 - 3 Press ●
- 5 Press ☰ to exit

Editing Distribution Rule

After Step 2, select a number ▶ Press ☰ Options ▶ Select *Edit* ▶ Press ● ▶ Press ☰ Edit ▶ Edit the rule ▶ Press ●

Changing Distribution Rule (Phone Number/Address)







After Step 2, select a number ▶ Press ☰ Options ▶ Select *Replace* ▶ Press ● ▶ Enter a number or address (see P.14-12) ▶ Press ●

Deleting Distribution Rule

After Step 2, select a number ▶ Press ☰ Options ▶ Select *Remove* ▶ Press ●

Replying to Messages

Main Menu ► Messages ► Received







- 1 Select a message and press ●
- 2 Press  **Options**
- 3 Select **Reply** or **Reply All** and press ●
New Message window opens.
 - Use MMS to send messages to up to 20 recipients at once.
 - Select **Reply All** to send the same message to all recipients (To/Cc). **Reply All** may not appear for some messages.
- 4 Enter text and press ●
- 5 Press  until  appears on Media Console
 - Skip this step if it is already on Display.
- 6 Use  to select  **Send** and press ●
Mail Setting window opens.
 - For MMS messages, subject is automatically entered prefaced with **Re:**.
- 7 Select **Send Message** and press ● 

Tip ►

- If the sender has set reply address, that address automatically appears in the **To:** field.
- Set whether or not to quote original message (see P.14-32).
- For **Reply All**, your handset is included in recipients.

Forwarding Messages









Main Menu ► Messages

- 1 Select **Received** or **Sent** and press ●
- 2 Select a message and press ●
- 3 Press  **Options**
- 4 Select **Forward** and press ●
New Message window opens.
- 5 Press  until  appears on Media Console
 - Skip this step if it is already on Display.
- 6 Use  to select  **Send** and press ●
Recipient Entry window opens.
- 7 Enter recipient and press ●
Mail Setting window opens.
 - For MMS messages, subject is automatically entered prefaced with **Fw:**.
 - Entering Recipient: see P.14-12
- 8 Select **Send Message** and press ● 
Message is forwarded.
 - Files attached to the original message are automatically attached to the forwarding messages.

Tip ► An MMS message is always forwarded as an MMS message.

Sending from Draft

Main Menu ► Messages ► Draft

- 1 Select a message and press** 
 - New Message window opens.
- 2 Press**  **until**  **appears on Media Console**
 - Skip this step if it is already on Display.
- 3 Use**  **to select**  **Send** **and press** 
- 4 Enter a recipient if necessary and press** 
 - Entering Recipient: see P.14-12
- 5 Select *Send Message* and press**  
 - Sent messages are deleted from Draft.







Editing Draft Messages

- After Step 1, edit a message and save it (see P.14-15).
(The original message is overwritten.)













Protecting a Message

Protect important messages in Received or Sent folder from inadvertent deletion.

Main Menu ► Messages

- 1 Select *Received* or *Sent* and press** 
- 2 Select a message and press**  **Options**
 - To unprotect, select a message with .
- 3 Select *Advanced* and press** 
- 4 Select *Lock* or *Unlock* and press** 
 -  appears for the protected message.

Protecting Selected Messages

- After Step 1, press  **Options** ► **Select *Advanced*** ► **Press**  ► **Select *Multiple Select*** ► **Press**  ► **Select a message** ► **Press**  (**✓** appears) ► **Select messages** ► **Press**  **Options** ► **Select *Lock* or *Unlock*** ► **Press** 
- To uncheck, select a message with  ► **Press** 
 - To select all, press  **Options** ► **Select *Select All*** ► **Press** 
 - To uncheck all, press  **Options** ► **Select *Unselect All*** ► **Press** 

Deleting Messages

Selecting Messages to Delete

Main Menu ► Messages

- 1 Select **Received, Draft, Sent, Unsent or Personal Folders** (see P.14-17) and press ●

Message list appears (see P.14-19).

2 Deleting a Message

- 1 Select a message and press ▸ **Options**
- 2 Select **Delete** and press ●

Deleting Selected Messages

- 1 Press ▸ **Options**
- 2 Select **Advanced** and press ●
- 3 Select **Multiple Select** and press ●
- 4 Select a message and press ●

✓ appears on the right of the selected message.

■ To uncheck, select a message with ✓ ► Press ●

5 Repeat Step 4 to select messages

■ To select all, press ▸ **Options** ► Select **Select All** ► Press ●

■ To uncheck all, press ▸ **Options** ► Select **Unselect All** ► Press ●

- 6 Press ▸ **Options**

- 7 Select **Delete** and press ●

- 3 Press ▸ **Yes**

- 4 Press ◀ to exit

Deleting All in Mail Box

Protected messages cannot be deleted.

Main Menu ► Messages

- 1 Select **Received, Draft, Sent or Unsent folder** (see P.14-17) and press ●

Message list appears (see P.14-19).

- 2 Press ▸ **Options**

- 3 Select **Advanced** and press ●

- 4 Select **Delete All** and press ●

- 5 Press ▸ **Yes**

- 6 Press ◀ to exit

Deleting All in Personal Folders

Protected messages cannot be deleted.

Main Menu ► Messages ► Personal Folders

- 1 Select a folder and press ●
Message list appears (see P.14-19).
- 2 Press ▢ Options
- 3 Select *Advanced* and press ●
- 4 Select *Delete All* and press ●
- 5 Press ▢ Yes
- 6 Press ⏪ to exit

Auto Delete

When memory is full, oldest received/sent messages are automatically replaced by new messages.

- To prevent deletion, protect important messages (see P.14-24).
- *Sent* is set by default.

Main Menu ► Messages ► Settings ► General Settings ► Auto Delete

- 1 Select an item and press ●
 - ▢ To turn off Auto Delete, select *None* ► Press ●
 - ▢ To set Auto Delete for both Received and Sent folders, select *Both* ► Press ●
- 2 Press ⏪ to exit

Linked Info

Saving Linked Info to Phone Book

Save linked phone numbers, mail addresses and URLs from message text and sender's/recipient's address to Phone Book. Selected numbers can only be saved when colour changes.

Main Menu ► Messages

- 1 Select *Received* or *Sent* and press ●
Message list appears (see P.14-19).
- 2 Select a message and press ●
- 3 *Saving Sender/Recipient Number or Address*
 - 1 Press ▢ Options
 - 2 Select *Save Address* and press ●
 - 3 Select a number or address and press ●

Saving Number in Text

 - 1 Select a number and press ●
 - 2 Select *Save to Phone Book* and press ●
- 4 Select *As New Entry* and press ●
Number or address is entered in corresponding Phone Book field. Complete other fields and save (see P.4-3 - 4-5).
 - ▢ To add to existing entry, select a Phone Book entry ► Press ● ► Press ▢ Save

Using Linked Info

Use numbers (**TEL:**), addresses or URLs (**http://**, **https://** or **rtsp://**) to place calls, send MMS messages or access Mobile Internet sites. Selected items can only be used when colour changes.

Main Menu ► Messages

1 Select *Received* or *Sent* and press ●

Message list appears (see P.14-19).

2 Select a message and press ●

- Open a message containing a phone number, mail address or URL.

3 Phone Numbers

1 Select a number and press ●

2 Select *Call* or *TV Call* and press ●

The number is dialled.

Mail Addresses

1 Select an address and press ●

2 Select *Message* and press ●

Creating a Message: see P.14-7 - 14-8

URLs

1 Select a URL and press ●

Handset connects to the Network.

- For URLs with **rtsp://**, video or sound is played back (see P.13-14 "Streaming").

Saving Attachments to Data Folder

Save attachments (images, sounds, vFiles, etc.) to Data Folder.

Main Menu ► Messages



1 Select *Received* or *Sent* and press ●

Message list appears (see P.14-19).

2 Select a message and press ●

- Select a message with attachments.

3 Select a file

- To open properties, select a file ► Press  **Options** ► Select **Details** ► Press ●
 - Press  **Back** to return.

4 Press **Options**

5 Select *Save Item* and press ●

Data Folder opens.

- To save to SD Memory Card Data Folder, press .
- To save to a sub folder, select folder ► Press ●

6 Select *Save here* and press ●

7 Enter title (file name) and press

- To accept the default title (file name), press .

8 Press

File is saved to Data Folder.

- When memory is full, notification appears. Delete files and try again (see P.8-14).

9 Press and then to exit

Mail Box List

Message Details Open message properties

Main Menu ▶ Messages

Select Received, Draft, Sent, Unsent or Personal Folders (see P.14-17) ▶ Press ▶ Select a message ▶ Press

Options ▶ Select *Message Details* ▶ Press

- Press to return.

Read/Unread

Change received message status from read to unread or vice versa

Main Menu ▶ Messages ▶ Received

Switching Status of a Message

Select a message ▶ Press **Options** ▶ Select *Advanced* ▶ Press ▶ Select *Switch to Unread* or *Switch to Read* ▶ Press

Switching Status of Selected Messages

Press **Options** ▶ Select *Advanced* ▶ Press ▶ Select *Multiple Select* ▶ Press ▶ Select a message ▶ Press (✓ appears) ▶ Select messages ▶ Press **Options** ▶ Select *Switch to Unread* or *Switch to Read* ▶ Press

- To uncheck, select a message with ✓ ▶ Press
- To select all, press **Options** ▶ Select *Select All* ▶ Press
- To uncheck all, press **Options** ▶ Select *Unselect All* ▶ Press

Tip ▶ Status may not be changed depending on the message.

Server Mail

Retrieving Mail List

Use Acquire Mail List to receive Mail List from the Centre then select messages to retrieve.

Main Menu ► Messages

1 Select **Server Mail Box** and press ●

To open received Mail List, select **Mail List** ► Press ●

2 Select **Acquire Mail List** and press ●

After download, Mail List appears.

- When Mail List has already been received, it is refreshed.

Retrieving All Server Mail

After Step 1, select **Retrieve All Mails** ► Press ●

Deleting All Server Mail

After Step 1, select **Delete All Mails** ► Press ● ►

Press **Yes**

Checking Server Mail Volume

After Step 1, select **Server Mail Volume** ► Press ●

■ To refresh, press **Update** ► Press **Yes**

■ Press **Back** to return.

Retrieving Selected Messages

Main Menu ► Messages

- 1 Select *Server Mail Box* and press ●
- 2 Select *Mail List* and press ●
- 3 Select a message and press ●

Download starts.

- Retrieved messages are deleted from Mail List and saved to Received folder.

Deleting Selected Messages

Main Menu ► Messages

- 1 Select *Server Mail Box* and press ●
- 2 Select *Mail List* and press ●
- 3 Select a message and press ▢ Options
- 4 Select *Delete* and press ●
- 5 Press ▢ Yes

Forwarding Server Mail

Forward Server Mail directly to PCs, etc.

Main Menu ▶ Messages ▶ Received

1 Open a message (MMS Notice)

- Select an MMS message with .

2 Press Options

3 Select **Forward** and press

4 Enter a forwarding number or address and press

Mail Setting window opens.







- Subject is automatically entered prefaced with **Fw:**

Entering Recipient: see P.14-12

5 Select **Send Message** and press

Message is forwarded.

From Mail List

Press  ▶ Select **Messages** ▶ Press  ▶ Select **Server Mail Box** ▶ Press  ▶ Select **Mail List** ▶ Press  ▶ Select a message ▶ Press  Options ▶ Select **Remote Forward** ▶ Press  ▶ Perform Steps 4 - 5

Mail Settings

General Settings

Home Download Set download option for Home Network system
(In Japan only default setting is available)
Default Always defer

Main Menu ▶ Messages ▶ Settings ▶ General Settings ▶
Home Download

Select an item ▶ Press 

Roam. Download Select roaming download option for handset
use outside Japan
Default Always defer

Main Menu ▶ Messages ▶ Settings ▶ General Settings ▶
Roam. Download

Select an item ▶ Press 

Delivery Report Request Delivery Reports for sent messages
(see P.14-20)
Default Off

Main Menu ▶ Messages ▶ Settings ▶ General Settings ▶
Delivery Report

Choose **On** or **Off** ▶ Press 

Edit Signature Create or edit signature text

Main Menu ▶ Messages ▶ Settings ▶ General Settings ▶ Edit
Signature

Press  Options ▶ Select **Edit** ▶ Press  ▶ Enter
signature ▶ Press  twice

Delivery Rep. Allow

Select whether or not to send delivery status to senders requesting Delivery Reports.

Default Off

Main Menu

► Messages ► Settings ► General Settings ► Delivery Rep. Allow

Choose On or Off ► Press ●

Reply History

Quote the original message text when replying

Default Off

Main Menu

► Messages ► Settings ► General Settings ► Reply History

Choose On or Off ► Press ●

In addition to above settings, use Expiry Time to set a time limit to store sent messages at the Centre.

SMS Settings

Message Centre

Set SMS Centre Number

Default +819066519300

Main Menu

► Messages ► Settings ► SMS Settings ► Message Centre

Press ⏏ **Options** ► **Select Edit** ► **Press** ● ► **Enter SMS Centre Number** ► **Press** ● **twice**

- Do not change Centre Number unless instructed to do so.

Message Format

Select a message format for new SMS messages

Default Normal

Main Menu

► Messages ► Settings ► SMS Settings ► Message Format

Select a format ► Press ●

Reply Path

Select whether or not to use the same SMS Centre Address for sent messages and replies

Default Off

Main Menu

► Messages ► Settings ► SMS Settings ► Reply Path

Choose On or Off ► Press ●

Text

Optimisation

Replace some French/German special characters with similar English alphabets

Default On

Main Menu

► Messages ► Settings ► SMS Settings ► Text Optimisation

Choose On or Off ► Press ●

MMS Settings

Slide Duration Set a display time for each slide

Default 3 Seconds

Main Menu ▶ *Messages* ▶ *Settings* ▶ *MMS Settings* ▶ *Slide Duration*

Press  **Options** ▶ **Select Edit** ▶ **Press**  ▶ **Enter time** ▶ **Press**  **twice**

Max Message Size Reject messages larger than a specified size

Default 300 KB

Main Menu ▶ *Messages* ▶ *Settings* ▶ *MMS Settings* ▶ *Max Message Size*

Select a size ▶ **Press** 

Memory Status

Check memory status of Mail Box.

Main Menu ▶ *Messages*

1 **Select *Memory Status* and press** 

 Press  **Back** to return.

V-applications

V-application Basics

Getting Started

Network Connection

Network V-applications require a network connection.

- Before using an application, a message appears indicating that a network connection is required. To disable the network connection confirmation message, see **P.15-7**.
- For connection fees, contact Vodafone Customer Centre, General Information (see **P.16-32**).

SD Memory Card

Synchronise SD Memory Cards used on other Vodafone handsets, PCs and other devices to update V-appli Library.

- Perform Network Setup before using Web (see **P.13-4**).
- Update V-appli Library to avoid malfunction.

Main Menu ▶ *V-appli* ▶ *Settings* ▶ *Synchronisation*

1 Press  **Yes**

Note ▶ V-applications saved to SD Memory Cards from your handset are exclusively for use on 802SH with your USIM Card or a newly purchased Vodafone handset.

Tip ▶ It may take some time to update V-appli Library depending on the number of files saved, etc.

Downloading V-applications

- Perform Network Setup before using Web (see P.13-4).
- Some V-applications can be downloaded to SD Memory Cards.
- Make sure signal is strong.

Main Menu ▶ V-appli ▶ V-appli Library ▶ More V-Appli

1 Open a Mobile Internet site offering V-applications

2 Select a V-application and press **Start download**

After **Application received data. Analysing...**, properties appear.

When a V-application is paused (⏸ appears in grey), press **Yes**.

3 Press **Start download**

Download starts.

- Download may take time.

To stop the download, press **Back**.

4 V-application is automatically saved after download and a confirmation appears

- When you download a new version of V-application set as Screensaver, a confirmation appears.

5 Press **Yes**

Web closes and V-appli Library opens.

To return to the site, press **No**.

Starting V-applications: see P.15-4

V-application Properties

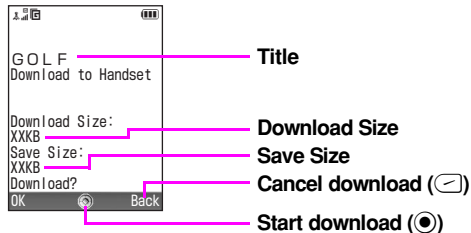

Properties of V-applications appear before proceeding to download. Check information and start.

Starting V-applications

Operate V-applications with handset open (clamshell open).

Main Menu ▶ *V-appli*

1 Select *V-appli Library* and press

V-appli Library opens.

- When a V-application is paused (⏸ appears in grey), press .
- To use V-application on SD Memory Card, press .

2 Select a V-application and press

V-application starts (⏸ appears).

- For operations, refer to the source Mobile Internet site, etc.
- If the V-application cannot be used, V-appli Library returns.

When the V-application can be set as Screensaver, press **Yes** or **No**.

Tip ▶ When receiving calls/mail, a running V-application pauses. To set it to remain active, see **P.15-9** "Calls & Alarms".

Starting Network V-applications

■ When a network connection confirmation message appears after Step 2, follow these steps.

Choose *On* or *Off* ▶ Press ▶ V-application starts

- To disable the confirmation message, see **P.15-7**.

■ If Off Line Mode is active (see **P.2-18**), follow these steps after Step 2.

Press **Yes or **No** ▶ V-application starts**

■ Set Security Level for some V-applications (see **P.15-7**).

Java™ Licence Information

Press ▶ Select *V-appli* ▶ Press ▶ Select *Information* ▶ Press

Memory Status

Press ▶ Select *Settings* ▶ Press ▶ Select *Memory Settings* ▶ Press ▶ Select *Memory Status* ▶ Press ▶ Select *Handset* or *Memory Card* ▶ Press

Exit, Pause & Resume

Exiting or Pausing V-applications

1 Press  while using a V-application

2 Exiting V-application

1 Select **End** and press 

V-appli Library returns ( disappears).

Pausing V-application

1 Select **Suspend** and press 

Standby returns with  (grey).



- V-application resumes from where it was paused.

Resuming V-applications

1 While a V-application is paused, press  in Standby

-  (grey) remains in Standby when there is a paused V-application.

2 Select **Resume** and press 

- To end the V-application, select **End** ➔ Press 
- To return to Main Menu, select **Cancel** ➔ Press 



Managing V-applications

Properties

View V-application details

Main Menu ▶ V-appli ➔ V-appli Library

Select a V-application ➔ Press  **Options** ➔ Select Information ➔ Press 

- To read the rest, press . (Press  to scroll back.)
- Press  **Back** to return.



Title	Title of the V-application
Vendor	Name of the distributor (or supplier/manufacturer)
Version	Version of the V-application
Description	Description of the V-application
Save Size	File size of the V-application
Recorded	Record game scores, etc. up to this size
Screensaver	Compatibility for Screensaver
Profile	Versions: VSCL (Overseas)/JCL (Domestic)
Link	Web information of the linked site
Certification	Trusted/Untrusted
Push	Compatibility for Push service

Move to Card Move V-applications to SD Memory Card

Main Menu ▶ V-appli ▶ V-appli Library

Select a V-application ▶ Press  **Options** ▶ Select **Move to Card** ▶ Press 

When an older version of the V-application is saved, press

 **Yes** or  **No**.

▪ Press  **Yes** to overwrite.

- A V-application cannot be moved to SD Memory Card when the same V-application is already saved.

Delete Delete V-applications

Main Menu ▶ V-appli ▶ V-appli Library

Select a V-application ▶ Press  **Options** ▶ Select **Delete** ▶ Press  ▶ Press  **Yes**

- Handset Code may be required.
- If the V-application is set as Screensaver, a confirmation appears and V-appli Library returns. To proceed, cancel the setting and retry.

Using V-applications

Setting Screensaver

Activate a V-application to run in Standby.

- Only one V-application can be set at a time, and some do not run in Standby.
- This setting is not available when a V-application is paused ( appears in grey).
- V-applications on SD Memory Card cannot be set as Screensaver.
- Screensaver is **Off** by default.

Main Menu ▶ V-appli ▶ Screensaver ▶ Switch On/Off

1 Choose On and press 

 To cancel, choose **Off** ▶ Press 

2 Select Set Application and press 

3 Select a V-application and press 

4 Press  **Yes**

5 Press  to exit

Activation Time

V-application set as Screensaver starts after Activation Time elapses. Set time as follows.

Press ● ➔ Select *V-appli* ➔ Press ● ➔ Select *Screensaver* ➔ Press ● ➔ Select *Activation Time* ➔ Press ● ➔ Enter time (01 - 10 seconds) ➔ Press ●

Suspend Time

Set idle time before V-application set as Screensaver pauses.

Press ● ➔ Select *V-appli* ➔ Press ● ➔ Select *Screensaver* ➔ Press ● ➔ Select *Suspend Time* ➔ Press ● ➔ Select time ➔ Press ●

- Note** ▶
- If handset (with SD Memory Card) is connected to Multi Stereo Headphones, V-application set as Screensaver does not start. V-application set as Screensaver closes if you connect Headphones to handset (with SD Memory Card).
 - V-applications may not start when an external device (handsfree kit, etc.) is connected to handset.
 - V-application set as Screensaver that also responds to incoming communications may take priority over settings for incoming communications in Mode Settings.

Setting Security Level

Customise the method of confirmation, etc. for each V-application operation below.

- Settings:

Phone Call	Place Voice Calls
Network Access	Connect to the Network
Messaging	Send/receive messages
Auto Run	Execute Auto Run files
Local Connection	Connect to other devices
Read User Data	Access Phone Book, Calendar, etc.
Write User Data	Edit Phone Book, Calendar, etc.
Use Multimedia	Use Media Player
Location Access	Send location info

- These settings are also available for V-applications on SD Memory Card.
- Security Level setting may not be available for some V-applications.

Main Menu ▶ *V-appli* ➔ *V-appli Library*

- 1 Select a V-application and press  Options
- 2 Select *Security Level* and press ●
- 3 Select an item and press ●

4 Select an option and press

- Some options may not appear.

Session	Confirmation appears every time V-applications start
Ask Once	Confirmation appears before the specific operation
Blanket	No confirmation
No	Reject the operation

Additional Functions

V-application Operational Settings

Application Volume

Adjust the volume of V-application sounds

Default Level:3

Main Menu ► *V-appli* ► *Settings* ► *Application Volume*

Use  (adjust the volume) ► **Press** 

- In Manner mode, volume set in Manner settings applies.

Backlight

Select a Backlight status for V-applications

Default Normal Settings

Main Menu ► *V-appli* ► *Settings* ► *Backlight* ► *Switch On/Off*

Select from **Always On** to **Normal Settings** ► **Press** 

Always On	Backlight remains on while V-applications are running
Always Off	Backlight does not turn on while V-applications are running
Normal Settings	Backlight turns on/off depending on Backlight setting in Display Settings (see P.10-6)

Blink

Backlight flashes while compatible V-applications play

Default On

Main Menu ► *V-appli* ► *Settings* ► *Backlight* ► *Blink*

Choose **On** or **Off** ► **Press** 

Vibration

Handset vibrates while compatible
V-applications play

Default On

Main Menu ▶ V-appli ▶ Settings ▶ Vibration

Choose On, Link to Sound or Off ▶ Press ●

- In Manner mode, vibration set in Manner settings applies.

Calls & Alarms

Select a handset response to incoming calls,
etc. while a V-application is active

Default Call/Message/Alarm Priority

Main Menu ▶ V-appli ▶ Settings ▶ Calls & Alarms

Select from Incoming Call to Alarm ▶ Press ● ▶

Select a handset response ▶ Press ●

Call/Message/ Alarm Priority	V-applications pause for incoming calls, mail, etc.
Call/Message/ Alarm Notice	A message appears for incoming calls, mail, etc. For example, *090392XXXX1 appears. Press ⏏ to answer the call or read the message, etc.

- For V-applications set as Screensaver, appropriate Notice appears regardless of the settings.

Reset

Set to Default All settings for V-applications return to default

Main Menu ▶ V-appli ▶ Settings ▶ Set to Default

Enter Handset Code ▶ Press ● ▶ Press ⏏ **Yes**

- The settings affected by Set to Default:

Application Volume	Level:3	
Backlight	Switch On/Off: Normal Settings Blink: On	
Vibration	On	
Calls & Alarms	Call/Message/Alarm Priority	
Screensaver	Activation Time	3 seconds
	Suspend Time	Off

Memory All Clear Delete all V-applications in V-appli Library

Main Menu ▶ V-appli ▶ Settings ▶ Memory All Clear

Enter Handset Code ▶ Press ● ▶ Press ⏏ **Yes**

Appendix

Function Menu





Main Menu	Sub Menu	Refer to
V-appli	V-appli Library	P.15-4
	Screensaver	P.15-6
	Settings	P.15-8
	Information	P.15-4
Vodafone live!	-	P.13-6
Media Player	-	P.7-2
Messages	Create New	P.14-7
	Received	P.14-17
	Personal Folders	P.14-20
	Draft	P.14-17
	Templates	P.14-16
	Sent	P.14-17
	Unsent	P.14-17
	Server Mail Box	P.14-29
	Voice Mail	P.12-4
	Settings	P.14-31
Memory Status	P.14-33	
Camera	-	P.6-2

Main Menu	Sub Menu	Refer to
Data Folder	Pictures	P.8-2
	DCIM	P.8-2
	Videos	P.8-2
	Sounds&Ringtones	P.8-2
	V-appli	P.15-2
	Bookmarks	P.13-11
	My Saved Page	P.13-11
	Text Templates	P.8-13
	Other Documents	P.8-2
	Tools	Calendar
Alarms		P.11-5
Calculator		P.11-8
Voice Recorder		P.11-9
Stopwatch		P.11-17
Tasks		P.11-18
World Clock		P.11-20
Countdown Timer		P.11-21
Expenses Memo		P.11-22
SD Local		-
SIM Application*		-
Photo Print		P.11-22
E-Book		P.11-24
Phone Help		P.11-28
Phone Book		Phone Book List
	Manage Group	P.4-7
	Speed Dial List	P.4-12
	My Details	P.4-13
	Advanced	P.4-8

* Available only when compatible USIM Card is used.

Main Menu	Sub Menu	Refer to
Barcode	Scan Barcode	P.11-11
	Open Barcode	P.11-13
	Create QR Code	P.11-14
	Scan Text	P.11-15
	Scanned Results	P.11-13
Connectivity	Bluetooth	P.9-3
	Infrared	P.9-9
	Network Settings	P.9-14
	Internet Setting	P.9-15
	Backup/Restore	P.9-19
Call Log	All Calls	P.2-11
	Missed Calls	P.2-11
	Received Calls	P.2-11
	Dialled Numbers	P.2-11
	Call Timers	P.2-12
	Call Costs	P.2-13
	Message Recorder	P.2-20
Settings	Mode Settings	P.10-2
	Display Settings	P.10-4
	Sound Settings	P.10-6
	Time & Date	P.10-7
	言語選択 (Language)	P.10-5
	User Dictionary	P.10-8
	Call Settings	P.10-9
	TV Call Settings	P.5-5
	Security	P.10-10
	Memory Settings	P.10-13
	LBS Settings	P.10-13
	Master Reset	P.10-14

Troubleshooting

Problem	Possible Cause	Solution
Handset does not turn on	<ul style="list-style-type: none"> • Is  pressed for 2+ seconds? • Is battery low or dead? • Is battery installed? 	<ul style="list-style-type: none"> • Press  for 2+ seconds. • Charge battery or install a charged battery. • Install battery properly.
Handset does not respond	<ul style="list-style-type: none"> • Is Switch On/Off in PIN Entry On? 	<ul style="list-style-type: none"> • When Switch On/Off in PIN Entry is On, PIN1 is required. Follow onscreen instructions (see P.10-10).
Insert SIM Card appears when handset is turned on or operation is attempted	<ul style="list-style-type: none"> • Is USIM Card inserted properly? • Is USIM Card correct? • Is IC chip or terminal clean without fingerprints, etc.? 	<ul style="list-style-type: none"> • Check if USIM Card is inserted properly. If inserted properly, Card may be damaged. • Check if an appropriate USIM Card is inserted. Inserted Card may be improper. • Wipe with clean, dry cloth and insert properly.
Keypad does not respond	<ul style="list-style-type: none"> • Is Keypad Lock active? ( appears) • Is Phone Lock active? ( appears) 	<ul style="list-style-type: none"> • Cancel Keypad Lock (see P.1-29). • Cancel Phone Lock (see P.10-11).
Beep continues after dialling and call cannot be connected	<ul style="list-style-type: none"> • Did you dial the number including the dialling code or first 0? • Is handset out-of-range? (OUT appears) • Is handset off-line? ( appears) 	<ul style="list-style-type: none"> • Dial the number including the dialling code or 0. • Move to a place where signal is strong and retry. • Cancel Off Line Mode (see P.2-18).
OUT appears and cannot make calls from handset	<ul style="list-style-type: none"> • Is handset out-of-range? 	<ul style="list-style-type: none"> • Move to a place where signal is strong and retry.

Problem	Possible Cause	Solution
Calls are interrupted or cut	<ul style="list-style-type: none"> • Is signal weak? • Is battery low or dead? 	<ul style="list-style-type: none"> • Move to a place where signal is strong and retry. • Charge battery or install a charged battery.
Cannot enter numbers from handset Keypad	<ul style="list-style-type: none"> • Is Keypad Lock active? (🔒 appears) • Is Phone Lock active? (🔒 appears) 	<ul style="list-style-type: none"> • Cancel Keypad Lock (see P.1-29). • Cancel Phone Lock (see P.10-11).
Cannot place calls from Phone Book	<ul style="list-style-type: none"> • Is the number saved as Secret mode entry? • Is Phone Book Lock active? 	<ul style="list-style-type: none"> • Activate Secret mode (see P.10-12). • Cancel Phone Book Lock (see P.10-11).
Hear noise while talking	<ul style="list-style-type: none"> • This may happen when signal is weak or unstable. 	<ul style="list-style-type: none"> • Move to a place where signal is strong.
Cannot charge battery	<ul style="list-style-type: none"> • Is AC Charger connected correctly to handset or Desktop Holder? • Is AC Charger plugged in firmly? • Is battery installed? • Is handset in Desktop Holder correctly? • Are handset, battery, Charger terminals & Connection Terminal (Desktop Holder) and External Device Connector clean? • Battery may not be charged if temperature is not within 5°C to 35°C. • Battery has run out or is defective. 	<ul style="list-style-type: none"> • Plug in again. • Plug in again. • Install battery properly. • Insert correctly. • Clean with a cotton swab. • Handle within ambient temperature of 5°C - 35°C. • Replace battery with a new one.
Charging time is shorter	<ul style="list-style-type: none"> • Charging time shortens when battery is not empty. 	-
Handset or accessories are hot	<ul style="list-style-type: none"> • AC Charger or Desktop Holder may heat up while charging. Handset may also heat up if used for long periods. This is normal if they are not extremely hot. 	-

Problem	Possible Cause	Solution
Battery runs out quickly	<ul style="list-style-type: none"> Battery runs out faster depending on the environment (temperatures, charging/signal conditions), usage or settings. 	<ul style="list-style-type: none"> Refer to "Estimated Hours of Use (fully charged battery)", "Battery Time" and "Extend Battery Time" (see P.1-17 - 1-18).
Display flickers	<ul style="list-style-type: none"> Display may flicker under fluorescent lights. 	-
Display is dark when Backlight is off	<ul style="list-style-type: none"> Panel construction characteristic; not a malfunction. 	-
Sound does not come from handset speaker	<ul style="list-style-type: none"> Is Manner mode set? 	<ul style="list-style-type: none"> Cancel Manner mode (see P.2-17).
Cannot use Bluetooth or USB transmission with Handset Manager	<ul style="list-style-type: none"> Is PC port for Bluetooth or USB connection the same as the port set in Handset Manager? 	<ul style="list-style-type: none"> Set the same port in interface settings of Handset Manager.
Cannot connect handset with Handset Manager	<ul style="list-style-type: none"> Is Handset Manager operating properly? 	<ul style="list-style-type: none"> Reboot the computer.

- Tip** ►
- If transmission is cancelled with handset while files are being transferred using Handset Manager, the command may not be accepted depending on timing.
 - For repairs and after-sales services, contact Vodafone Customer Centre, Customer Assistance (see **P.16-32**).

Indicators & Recharge Warning

■ OUT appears

Handset is out-of-range. Move for a better signal.

■ **Recharge battery.** appears and short beeps sound

Battery is low (see **P.1-19**).

Charge or replace battery immediately.

■ appears

Keypad Lock is active (see **P.1-29**).



Cancel to use Keypad. Press keys for Any Key Answer to answer calls (see **P.2-5**).



■ appears

Phone Lock is active (see **P.10-11**).

Cancel to place calls, etc. Press keys for Any Key Answer to answer calls (see **P.2-5**).

V-application Display Messages

Display	Cause	Solution
Application is currently suspended. End application?	<ul style="list-style-type: none"> A V-application is paused. 	<ul style="list-style-type: none"> Close the application and try again.
<p>○○ Download to Handset</p> <p>Download Size: XXKB Save Size: XXKB Download? Battery low. Download may not complete.</p>	<ul style="list-style-type: none"> Download may fail due to low battery. 	<ul style="list-style-type: none"> Charge battery beforehand.
<p>○○ Not Enough Memory in Handset. Download to Memory Card</p> <p>Download Size: XXKB Save Size: XXKB Download?</p>	<ul style="list-style-type: none"> Library memory is full. 	<ul style="list-style-type: none"> Press  OK to continue downloading and press  Back to cancel.
Exceeds limit cannot save.	<ul style="list-style-type: none"> 100 V-applications are already saved. The message appears as a confirmation. 	<ul style="list-style-type: none"> Delete applications and try again (see P.15-6).

Display	Cause	Solution
New Version Found Continue Download?	<ul style="list-style-type: none"> You are downloading a new version of the saved application. 	<ul style="list-style-type: none"> Press  Yes to continue downloading and press  No to cancel.

Tip ► V-applications cannot be downloaded when the following messages appear:

- *Improper data cannot download application.*
- *Application size too large. Cannot download.*

Display Messages (Messaging)

Messages with image attachments cannot be sent

Possible causes include the following. For details, contact Vodafone Customer Centre, General Information (see **P.16-32**).

- **Recipient does not subscribe to MMS, Super Mail or Long Mail.**
- **Recipient handset is not MMS compatible.**
 - The maximum size which recipient can receive differs depending on recipient handset.
- **Recipient handset is not JPEG compatible.**
 - Convert JPEG files to PNG files before sending to PNG compatible handsets (see **P.8-13**).

When handset memory is full

New messages cannot be delivered. A confirmation message appears ( appears in red). Undeliverable mail is saved at the Centre.



























































































- Delete messages to free memory for new ones (see **P.14-25**). When memory is available, new messages are delivered automatically.
- Delete unprotected messages automatically to receive new ones (see **P.14-26**).
- Even if memory is not full, handset cannot receive new messages larger than remaining memory.

Pictograph List

Open Pictograph Code mode and press  **List**.

Use  to select a Pictograph and press  to enter it.



























































































■ Pictograph Code 1

Code	Pictograph	Code	Pictograph	Code	Pictograph	Code	Pictograph	Code	Pictograph
01		19		37		55		73	
02		20		38		56		74	
03		21		39		57		75	
04		22		40		58		76	
05		23		41		59		77	
06		24		42		60		78	
07		25		43		61		79	
08		26		44		62		80	
09		27		45		63		81	
10		28		46		64		82	
11		29		47		65		83	
12		30		48		66		84	
13		31		49		67		85	
14		32		50		68		86	
15		33		51		69		87	
16		34		52		70		88	
17		35		53		71		89	
18		36		54		72		90	

Note ▶ Pictographs do not appear in e-mail or on incompatible Vodafone handsets.

Tip ▶ Pictographs in  are animated.

Pictograph Code 2

Code	Pictograph	Code	Pictograph	Code	Pictograph	Code	Pictograph	Code	Pictograph
01		19		37		55		73	
02		20		38		56		74	
03		21		39		57		75	
04		22		40		58		76	
05		23		41		59		77	
06		24		42		60		78	
07		25		43		61		79	
08		26		44		62		80	
09		27		45		63		81	
10		28		46		64		82	
11		29		47		65		83	
12		30		48		66		84	
13		31		49		67		85	
14		32		50		68		86	
15		33		51		69		87	
16		34		52		70		88	
17		35		53		71		89	
18		36		54		72		90	

Pictograph Code 3

Code	Pictograph	Code	Pictograph	Code	Pictograph	Code	Pictograph	Code	Pictograph
01		19		37		55		73	
02		20		38		56		74	
03		21		39		57		75	
04		22		40		58		76	
05		23		41		59		77	
06		24		42		60		78	
07		25		43		61		79	
08		26		44		62		80	
09		27		45		63		81	
10		28		46		64		82	
11		29		47		65		83	
12		30		48		66			
13		31		49		67			
14		32		50		68			
15		33		51		69			
16		34		52		70			
17		35		53		71			
18		36		54		72			

Note ▶ Pictographs do not appear in e-mail or on incompatible Vodafone handsets.

Tip ▶ Pictographs in are animated.

Pictograph Code 4

Code	Pictograph	Code	Pictograph	Code	Pictograph	Code	Pictograph	Code	Pictograph
01		17		33		49		65	
02		18		34		50		66	
03		19		35		51		67	
04		20		36		52		68	
05		21		37		53		69	
06		22		38		54		70	
07		23		39		55		71	
08		24		40		56		72	
09		25		41		57		73	
10		26		42		58		74	
11		27		43		59		75	
12		28		44		60		76	
13		29		45		61		77	
14		30		46		62			
15		31		47		63			
16		32		48		64			

■ Pictograph Code 5

Code	Pictograph	Code	Pictograph	Code	Pictograph	Code	Pictograph	Code	Pictograph
01		17		33		49		65	
02		18		34		50		66	
03		19		35		51		67	
04		20		36		52		68	
05		21		37		53		69	
06		22		38		54		70	
07		23		39		55		71	
08		24		40		56		72	
09		25		41		57		73	
10		26		42		58		74	
11		27		43		59		75	
12		28		44		60		76	
13		29		45		61			
14		30		46		62			
15		31		47		63			
16		32		48		64			

Note ► Pictographs do not appear in e-mail or on incompatible Vodafone handsets.

Tip ► Pictographs in are animated.

Pictograph Code 6

Code	Pictograph	Code	Pictograph	Code	Pictograph	Code	Pictograph	Code	Pictograph
01		13		25		37		49	
02		14		26		38		50	
03		15		27		39		51	
04		16		28		40		52	
05		17		29		41		53	
06		18		30		42		54	
07		19		31		43		55	
08		20		32		44		56	
09		21		33		45		57	
10		22		34		46		58	
11		23		35		47			
12		24		36		48			

Note ► Pictographs do not appear in e-mail or on incompatible Vodafone handsets.

Tip ► Pictographs in  are animated.

Specifications

■ 802SH

Weight	Approximately 141 g (with battery)
Continuous Call Time	Approximately 150 minutes (3G) Approximately 240 minutes (GSM)
Continuous Standby Time (when closed)	Approximately 240 hours (3G) Approximately 250 hours (GSM)
TV Call Continuous Call Time	Approximately 90 minutes
Charging Time (Power off)	AC Charger: Approximately 135 minutes In-Car Charger: Approximately 145 minutes
Dimensions (W x H x D)	Approximately 50 x 102 x 26 mm (when closed, without protruding parts)
Maximum Output	0.25 W (3G) 2.0 W (GSM)

- Continuous Call Time is an average measured with a new, fully charged battery, with stable signals. Continuous Call Time may be less than half this value if handset is out-of-range or signal is weak.
- Continuous Standby Time is an average measured with a new, fully charged battery, with handset closed (clamshell closed) without calls or operations, in Standby with stable signals. Standby Time may be less than half this value if handset is out-of-range or signal is weak. Standby Time may vary by environment (battery status, temperature, etc.).

- Call Time and Standby Time will decrease if Display Backlight is used frequently.
- Call Time and Standby Time may decrease when a V-application is active.
- Call Time and Standby Time may decrease when handset is used in poor conditions (see **P.1-17** "Battery Time").
- Display employs precision technology. However, some pixels may appear brighter or darker.

■ AC Charger

Power Source	100 - 240 VAC, 50/60 Hz
Power Consumption	13 VA
Output Voltage/Current	5.2 VDC/650 mA
Charging Temperature	5°C - 35°C
Dimensions (W x H x D)	Approximately 53 x 49 x 20 mm (without protruding parts, cord)
Cord Length	Approximately 1.5 m

■ Desktop Holder

Input Voltage/Current	5.2 VDC/650 mA
Output Voltage/Current	5.2 VDC/650 mA
Charging Temperature	5°C - 35°C
Dimensions (W x H x D)	Approximately 58.5 x 26 x 132 mm (without protruding parts)

■ Battery

Voltage	3.7 V
Battery Type	Lithium-ion
Capacity	870 mAh
Dimensions (W x H x D)	Approximately 37.5 x 5.8 x 44.7 mm (without protruding parts)

■ Multi Stereo Headphones

Weight	Approximately 11 g
Cord Length	Approximately 90 cm

■ Handsfree Microphone

Weight	Approximately 12 g
Cord Length	Approximately 75 cm

Index

Numbers

3G (System Settings)	2-14
3G/GSM GPRS Modem.....	9-13

A

About (browser).....	13-16
AC Charger	1-22
Access Log (Web)	13-15
Access Point.....	9-16, 9-18
Acquire Dictionary	10-8
Acquire Mail List.....	14-29
Activation Time (Screensaver).....	15-7
Add Email Address	4-2
Add Slide.....	14-11, 14-12
Advanced Settings	14-14
Alarm	11-5
All Calls	2-11
Alternative Image (TV Call).....	5-5
Any Key Answer	2-5, 10-3
Application.....	9-15, 9-17
Application Volume (V-application).....	15-8
attaching files	14-9
Authentication (Web)	13-18
Authorisation code.....	9-9
Auto (System Settings).....	2-14
Auto Delete	14-26
Auto Save.....	6-18

B

Backlight	5-5, 7-7, 10-6, 15-8
Backup & Restore	9-19
Barcode (scanning).....	11-11
battery	1-16, 1-20
Battery Strength indicator	1-18, 1-19
Blink (V-application)	15-8
Bluetooth (introducing handset)	9-4
Bluetooth	9-3
Bluetooth Timeout	9-8
Bookmarks (accessing from).....	13-12
Bookmarks (deleting)	13-13
Bookmarks (editing)	13-13
Bookmarks (folder)	13-13
Bookmarks (saving).....	13-12
Bookmarks.....	13-11
Bracket	6-8
Brightness	10-6
Browser Data	13-16
By Group (Phone Book search).....	4-9
By Katakana (Phone Book search).....	4-9
By Reading Order (Phone Book search).....	4-9

C

Cache memory (Web)	13-5
Calculator.....	11-8
Calendar	11-2
Calendar Format.....	10-7

Display Size	7-7, 13-14
Downloads (downloading text only)	13-17
DPOF	11-22
Draft (editing)	14-24
Draft (Mail Box)	14-17
Draft (saving to)	14-15
Draft (sending from)	14-24

E

Earpiece Volume	2-9
E-Book	11-24
Edit Signature	14-31
Edit Subtitle	7-9
Emoticons	3-7
Enlarge/Reduce	8-8
entering characters	3-5
entry modes	3-2
Execute Pending	9-18
Expenses Memo	11-22
Expiry Time	14-14
Exposure	6-15
External Light (calls/messaging)	10-3

F

Face Arrange	8-9
fast forward/reverse	7-5
Favourites (Streaming)	13-14
Font Colour	14-9
Font Settings	10-5
Font Size	13-17
Format Card	10-13

Forward	14-5, 14-23, 14-31
Frame	8-13
Function Menu	16-2

G

General Settings	14-31
Greeting Message	10-5
GSM (System Settings)	2-14

H

Handset Code	1-33, 10-12
Handset Lock	10-11
Handset Manager	9-14
handset phone number (opening My Details)	4-13
Handsfree Devices (Bluetooth)	9-8
Handsfree Setting	9-8
Help	6-17
Hiragana to Katakana/Alphanumerics Conversion	3-12
Hold	2-3
Home Download	14-31

I

images (editing)	8-6
IMEI Notification	13-17
In-Car Charger	1-24
incoming calls (answering)	2-5, 5-3
Index Print	11-23
Information	2-6, 15-4
information content	13-5
Infrared	9-9
Input Memory (Web)	13-9

international call	2-3
International Prefix	10-9
international roaming	2-14
Internet (entering URLs directly)	13-7
Internet Setting	9-15

J

Jump to Bottom (Web)	13-16
Jump to Top (Web)	13-16

K

key assignments	3-3
Keypad Lock	1-29
Keypad Tones	10-3

L

Language (言語選択): 日本語/English	10-5
Language	10-5
LBS Settings	10-13, 13-17
LBS URL Setting	10-13
List Content	14-19
Lock/Unlock	14-24
Loudspeaker	2-9, 5-5

M

Mail address (customising handset address)	13-4
Mail Box	14-17
Main Menu	1-30
Manage Group (Phone Book)	4-7
Manner mode	2-16
Master Reset	10-16
Max Cost	2-13

Max Message Size	14-33
Media Console	14-7
Media Player	7-2
Memory All Clear (V-application)	15-9
Memory Card	1-25
Memory Settings	10-13
Memory Status	4-6, 10-13, 14-33, 15-4
Merge Panorama	8-11
Message Centre	14-32
Message Content	14-3, 14-20
Message Details	14-28
Message Format	14-32
Message Recorder	2-20
Message Type	14-14
Messaging (checking messages)	14-17
Messaging (creating/sending messages)	14-7
Messaging (deleting messages)	14-25
Messaging (editing messages)	14-18
Messaging (entering message text)	14-8
Messaging (entering recipient)	14-12
Messaging (entering subject)	14-13
Messaging (opening new messages)	14-2
Messaging (retrieving MMS messages)	14-4
Messaging	14-2
Microphone	6-17
Minute Minder	10-9
Missed Calls	2-11
MMS	13-2
MMS Settings	14-33
mobile camera	6-2
Mobile Internet (accessing)	13-6

Mobile Light (camera)	6-14
Mode Settings.....	10-2
Move to Card.....	15-6
Move to Folder	14-21
Multi Selector.....	i
Music Player	7-4
Mute Microphone.....	2-3, 5-5
My Details (Owner Profile).....	4-13
My Saved Page (accessing from)	13-12
My Saved Page (deleting).....	13-13
My Saved Page (saving to).....	13-12
My Saved Page	13-11

N

Network (add/change/delete)	9-14
network connection	15-2
Network Information	9-15
Network Password	1-33, 12-10
Network Settings	2-14, 9-14

O

Off Line Mode	2-18
One Hiragana Predictive Entry.....	3-13
One Hiragana Word Call	3-13
One-Hiragana Conversion	3-11
Operator Name	10-5
Options (Media Console)	14-7
out-of-range	16-4
Overlap mode	6-8

P

Pager Code	3-9
Pager Code list	3-10
Paired Devices (Bluetooth)	9-5
passcode.....	9-3
Paste.....	3-14
Pen Light.....	1-29
Personal Folders (Auto Sort)	14-22
Personal Folders	14-17, 14-20
Phone Book (deleting entries)	4-11
Phone Book (editing)	4-10
Phone Book (inserting in text)	3-15
Phone Book (Memory Status)	4-6
Phone Book (saving)	4-2
Phone Book (searching).....	4-9
Phone Book Lock.....	10-11
Phone Help	11-28
Phone Lock.....	10-11
Phonetic Conversion	3-11
Photo Camera.....	6-5
Photo Frame	6-10
Photo Print.....	11-22
Pictograph	3-7
Pictograph List	16-15
Picture (Media Console)	14-7, 14-9
Picture (Phone Book).....	4-5
Picture Size.....	6-13
Picture Size.....	6-15
Picture/Video Quality	6-16
PIN	1-7, 10-12

Playback Pattern	7-6, 7-7
playing Voice Mail	12-5
Playlist (Media Player)	7-11
Power Off Sound	10-3
Power On Sound	10-3
Power on/off.....	1-28
Predictive	3-6
Preview Message.....	14-8, 14-11
Previous Usage	3-6
Priority.....	14-15
properties.....	7-4, 8-5, 13-15, 15-5
Proxy	9-16, 9-18

Q

Quick Conversion.....	3-12
-----------------------	------

R

Received (Mail Box)	14-17
Received Calls	2-7, 2-11
Record Time.....	6-16
Reformat file	8-13
Rejected Numbers	12-9
Reload Page (Web).....	13-15
Remove Picture	14-10
Remove Slide.....	14-12
Remove Sound	14-10
Remove Text	14-10
Remove Video.....	14-10
Rename (folders)	14-20
Replace Picture	14-10
Replace Sound	14-10

Replace Video.....	14-10
replacing characters	3-14
Reply	14-5, 14-23
Reply All.....	14-5, 14-23
Reply Path.....	14-32
Re-Provisioning.....	9-18
Re-send	14-18
Reset All	10-14
Reset Settings	10-14
Restart Browser	13-16
Restore from Card.....	9-20
restricting incoming calls.....	12-9
restricting outgoing calls	12-8
Retouch.....	8-8
Retrieve All Mails	14-29
Retrieve NW Info	9-18, 13-4
Ringtone/Ringvideo	4-4, 10-2
Roam. Download	14-31
Root Certificates	13-18
Rotate (image)	8-13

S

Save and Send (video).....	6-12
Save as Template	14-16
Save Item (attachments).....	14-27
Save to (camera)	6-17
Save to Card	9-20
Save to Phone Book	13-9, 14-26
Scan Text	11-15
Scene (camera).....	6-15
Screensaver	15-6

Text Templates	3-15, 8-13
Time & Date	10-7
Timer (camera)	6-14
Tone Control	7-5
Touch Tone	2-9
TV Call (Hold Guidance Pict)	5-5
TV Call	5-2
TV Call Settings	5-5

U

Unsent (Mail Box)	14-17
URL log (Access History)	13-7
User Dictionary	10-8
USIM Card	1-4

V

V-appli Library	15-4
V-application (deleting)	15-6
V-application (downloading)	15-3
V-application (exiting or pausing)	15-5
V-application (resuming)	15-5
V-application (starting)	15-4
V-application	15-2
V-application properties (before downloading)	15-3
Vibration	10-3, 15-9
Video (Media Console)	14-7, 14-10
Video Camera	6-10
Video Encode	6-17
Video Player	7-6
View Attachments	14-11
Viewer position	1-14

Vodafone live!	13-2
Vodafone Web	13-6
Voice Mail	12-4
Voice Recorder	11-9
Volume	10-2

W

Wallpaper	10-4
Warning Tone	10-3
Web (moving cursor)	13-8
Web (saving files)	13-10
Web (uploading files)	13-16
Web	13-5
White List	9-18
Withheld Call	12-9
World Clock	11-20

Z

zoom (camera)	6-4
---------------------	-----

Warranty & After-Sales Services

■ Warranty

Warranty is provided when you purchase 802SH.

- **Check the name of distributor and date of purchase.**
- **Read through contents and keep in a safe place.**
- **The warranty term is described in the warranty.**

■ After-Sales Services

See **P.16-4** "Troubleshooting" before contacting us for repair. If you cannot find solutions or solve problems, contact Vodafone Customer Centre, Customer Assistance (see **P.16-32**) of your subscription area and provide detailed description.

- **During the warranty term, repairs are performed under the terms and conditions described in the warranty.**
- **After the warranty term, repairs are performed if possible upon your request at your expense.**

For other services, contact the distributor, the nearest **Vodafone shop** or **Vodafone Customer Centre, General Information** (see **P.16-32**).

Replacement parts are warranted for 6 years after termination of production.

Note ▶

- Vodafone is not liable for any damages resulting from use of this product.
- Vodafone is not liable for any damages resulting from accidental loss/alteration of handset data. Please keep a separate record of Phone Book entries, etc.
- Disassembling or modifying handset may violate the Radio Law. Modified handsets will not be repaired.

Customer Service

If you have questions about Vodafone handsets or services, please call General Information. For repairs, please call Customer Assistance.

Vodafone Customer Centres

From a Vodafone handset, call toll free at
157 for General Information or
113 for Customer Assistance

Call these toll free numbers from landlines:

Subscription Area	Service Centre	Phone Number
Hokkaido, Aomori, Akita, Iwate, Yamagata, Miyagi, Fukushima, Niigata, Tokyo, Kanagawa, Chiba, Saitama, Ibaraki, Tochigi, Gunma, Yamanashi, Nagano, Toyama, Ishikawa, Fukui	General Information	☎ 0088-240-157
	Customer Assistance	☎ 0088-240-113
Aichi, Gifu, Mie, Shizuoka	General Information	☎ 0088-241-157
	Customer Assistance	☎ 0088-241-113
Osaka, Hyogo, Kyoto, Nara, Shiga, Wakayama	General Information	☎ 0088-242-157
	Customer Assistance	☎ 0088-242-113
Hiroshima, Okayama, Yamaguchi, Tottori, Shimane	General Information	☎ 0088-259-157
	Customer Assistance	☎ 0088-259-113
Tokushima, Kagawa, Ehime, Kochi	General Information	☎ 0088-247-157
	Customer Assistance	☎ 0088-247-113
Fukuoka, Saga, Nagasaki, Oita, Kumamoto, Miyazaki, Kagoshima, Okinawa	General Information	☎ 0088-250-157
	Customer Assistance	☎ 0088-250-113

Vodafone 802SH Instruction Manual

March 2005, First Edition

Vodafone K.K.

For additional information, please visit a Vodafone shop.

Model: Vodafone 802SH

Manufacturer: SHARP Corporation



モバイル・リサイクル・ネットワーク
携帯電話・PHSのリサイクルにご協力を。

Please help the mobile industry maintain high environmental standards. Recycle your old handsets, batteries and charger units (all manufacturers and brands). Before you recycle, please remember these important points:

- Handset, batteries and chargers submitted for recycling cannot be returned.
- Always be sure to erase all data recorded on old handsets (Phone Book entries, call records, mail, etc.) before recycling.