

## EY-RC 504/505: Room automation station, ecos504/505

### How energy efficiency is improved

Powerful function modules in the ecos504/505 integrate the regulation of the room temperature, lighting and sunshading to create a comfortable room climate with minimum energy consumption

### Features

- Part of the SAUTER modulo 5 system family
- Modular room automation station (AS) for up to eight rooms or eight flexible room segments
- BACnet/IP communication (EN ISO 164845) as BACnet Building Controller (B-BC)
- The ecoUnit 3 and ecoUnit 1 room operating units enable individual adjustment of the room climate
- Optimises energy consumption thanks to presence function, window contact monitoring, demand-controlled ventilation, control of lighting and window blinds, and time-dependent setpoint specification
- Function libraries for climate, lighting and sunshading
- Expansion bus for remote ecoLink modules, ecoUnit room operating units and EnOcean wireless interface
- KNX interface to connect KNX operating units, sensors and actuators
- Integrated KNX tunnelling function (KNX/IP) for the commissioning of KNX with ETS
- DALI interface with DALI bus power supply for the connection of DALI electronic ballasts (EB) and DALI sensors
- Web-based commissioning tool for DALI network
- SMI interface (SMI/SMI LoVo) for activating SMI motors for sunshading (window blinds, roller shutters)
- Integrated tunnelling function for commissioning with SMI-easyMonitor
- RS-485 half duplex, electrically isolated interface for Modbus/RTU, Modbus/ASCII
- Baud rate 600 to 115,200 bit/s with configurable RS-485 network resistors
- Modbus master with up to four simultaneous communication profiles
- Integrated tunnelling function for commissioning and monitoring with serial Modbus master tools
- Physical M-Bus interface and RS-232 interface for external M-Bus level converters
- Supports M-Bus baud rates of 300 to 38,400 bit/s
- M-Bus master function with up to four simultaneous communication profiles
- Integrated tunnelling function for commissioning and monitoring with M-Bus tools
- Time programme and calendar function; data recording
- Integrated moduWeb web server (EY-RC504F101 only)
- Integrated (EY-RC504F202 only) or licensable MQTT functionality (MQTT Broker / Client)
- Engineering/programming using SAUTER CASE Suite (based on IEC 61131-3)
- Integration into the building management system via BACnet/IP with Ethernet interface

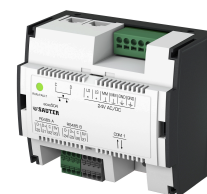

EY-RC 504

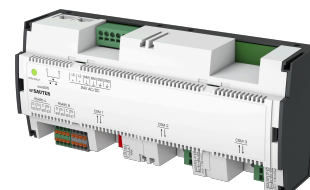

EY-RC 505



### Technical data

#### Power supply

Power supply	24 V= ±10%
	24 V~ +25%/-15%, 48...63 Hz
Max. peak inrush current	23 A (10 milliseconds)
Connection	Spring-type terminals
	0.2...2.5 mm <sup>2</sup> rigid/flexible
	Ampacity max. 5 A

#### Ambient conditions

Operating temperature	0...45 °C
Storage and transport temperature	-25...70 °C
Ambient humidity	10...85% rh, no condensation

#### Function

BACnet	BACnet profile	B-BC (EN ISO 16484-5)
	BACnet data point objects	600 (incl. HW)
	Control	32 (Loop)
	Active COV subscription	1500
	BACnet client links	200 (Peer-to-Peer)



Dynamic objects	Time programmes	32 (Schedule)
	Calendar	16 (Calendar)
	Alarms	16 (Notification Class)
	Historical data	256 (Trend Log) up to 60,000 entries
	Chart	32 (Log View), only moduWeb (F101)
	Command object	16 (Command)
Services	Number of BBMDs in BDT	32
	Number of FDs in FDT	32
Gateway	Field bus protocols	KNX, DALI, SMI, Modbus, M-Bus, SLC, SLC/EnOcean
	IP protocols	BACnet/IP as per ISO 16484-5, HTTP for moduWeb (F101 only), MQTT protocol V3.1.1/V5 as per ISO/IEC 20922 via TCP or TCP/TLS 1.2 (F202 only / licence)
MQTT	MQTT Client	Number of topics / alias topics for max. number of BACnet objects (600)
	MQTT Broker	Number of topics, depending on CPU/memory resources (> 1000)
<b>Architecture</b>		
	Processor	32-bit, 600 MHz (ARM)
	SDRAM (synchronous dynamic RAM)	128 MB
	SRAM (static RAM)	64 kB
	Flash	128 MB
	Operating system	Embedded Linux
	Cycle time	100 milliseconds
	Application data	Via CASE Engine
	Embedded web server	moduWeb (EY-RC504F101 only)
<b>Interfaces and communication</b>		
Ethernet network	Communication protocol	BACnet/IP, HTTP (F101 only), MQTT (F202 only or with licence)
	Connection	2 × RJ-45 connector
	Type	10/100 BASE-TX switched
RS-485 A, RS-485 B	Communication protocol	2 × RS-485, SLC
	Use	ecoLink I/O modules; ecoUnit 1, ecoUnit 3 operating units; ASV 2 VAV actuators
	Participant	Max. 2 × 8 ecoLink modules Max. 2 × 4 ecoUnit 1, 3 or FCCP 2 Max. 2 × 12 ASV 2
	Power supply	5 V ±5% < 200 mA (sum of both RS-485), protected against short circuit
	Connection	Pluggable spring-type terminals 2 × 4-pin 0.2...1.5 mm <sup>2</sup> rigid/flexible
	Line <sup>1)</sup>	4-wire, twisted, shielded
	Line length <sup>2)</sup>	Max. 100 m (30 m) with ecoUnit, up to 500 m, bus termination necessary
KNX	Communication protocol	KNX TP1 (ISO/IEC 14543-3)
	Power consumption	KNX bus max. 6 mA
	Bus power supply	Via external KNX power supply
	Connection	KNX bus terminal x4 0.6...0.8 mm rigid lines
	Line	KNX cable, 2-wire, twisted
	Use	KNX actuators and sensors
	Participant	Up to 64 KNX devices, depending on the external KNX power supply

<sup>1)</sup> Example cable CAT-5, J-Y(ST)Y, RS-485 bus cable (e.g. Belden 9842)

<sup>2)</sup> With the cable length and the conductor cross-section, the supply voltage (+5 V) for the ecoUnit 3 must not fall below the minimum required voltage due to the voltage drop.

	Functions	256 KNX group addresses for BACnet I/O objects (256 channels)
DALI (per COM module)	Communication protocol	DALI (IEC 62386-101/-103)
	Power consumption	DALI bus max. 2 mA (only when operating with external power supply)
	Bus power supply	Typ. 16 V, max. 116 mA (can be switched off for external bus power supply)
	Connection	Spring-type terminals 0.2...2.5 mm <sup>2</sup> rigid/flexible
	Line	2-wire, NYM..., up to 300 m
	Use	DALI ballasts (IEC 62386-102) DALI sensors (see list)
	Participant	Up to 64 DALI ballasts and 64 DALI sensors (depending on type and bus power supply)
	Functions	256 DALI functions for BACnet I/O objects (256 channels) with addressable 64 DALI short addresses and 16 group addresses
SMI (per COM module)	Communication protocol	SMI master (SMI standard V2.3.2)
	Bus power supply	Typ. 17 V, max. 20 mA, for 16 motors typ. 12.8 mA (0.8 mA/motor), protected against short circuit (30 mA)
	Connection	Spring-type terminals 0.2...2.5 mm <sup>2</sup> rigid/flexible
	Line	2-wire, NYM..., up to 350 m
	Use	SMI actuators, SMI (230 V) or SMI LoVo (see list)
	Participant	Up to 16 SMI motors
	Functions	128 SMI functions for BACnet I/O objects (128 channels) for up to 16 single and group addresses each
RS-485 (COM module)	Communication protocol	Modbus/RTU and Modbus/ASCII Master as per V1.02 2-wire (2W)
	Bus physics	1 unit load (unit load = UL); electrically isolated; integrated RS-485 network resistors (LT, PU, PD) configurable via software
	Bus speed	600...115,200 bit/s Parity bit, stop bit, Rx/Tx bus timing
	Connection	Pluggable spring-type terminals 2 × 5-pin 0.2...1.5 mm <sup>2</sup> rigid/flexible
	Line <sup>3)</sup>	3-/4-wire (D+/D-/COM reference), twisted, shielded, up to 1000 m
	Use	Integration of Modbus slaves in an RS-485 segment (line)
	Participant	Up to 31 RS-485 unit loads (UL)
	Functions	600 Modbus channels for BACnet I/O/V objects for up to 247 Modbus devices; FC01-06, 15, 16, 22; unicast and broadcast; access optimisation
	M-Bus/RS-232 (COM module)	Communication protocol
Bus physics		M-Bus (EN 13757-2); electrically isolated, mark voltage 36 V, short-circuit proof, overcurrent monitoring and protection
Bus speed		300...9600 (19,200, 38,400) bit/s
Connection		Pluggable spring-type terminals 2 × 5-pin 0.2...1.5 mm <sup>2</sup> rigid/flexible

<sup>3)</sup> Example cable CAT-5, J-Y(ST)Y, RS-485 bus cable (e.g. Belden 9842)

Line <sup>4)</sup>	2-wire (M+/M-) up to 1000 m; RS-232 (D+/D-/GND) up to 15 m
Use	Integration of M-Bus meters
Participant	Up to 40 M-Bus unit loads (UL of 1.5 mA); up to 256 M-Bus devices (with external M-Bus level converter via RS-232)
Functions	400 M-Bus channels for BACnet I/O/V objects for up to 256 M-Bus devices; REQ_UD2, SND_NKE, SND_UD, primary/secondary addressing, readout (triggered, by offset or filter)

## Construction

Fitting	DIN rail 35 × 7.5/15 EN 50022 Rail housing DIN 43880
Dimensions W x H x D	EY-RC 504:105 (6 HP) × 90 × 58 mm EY-RC 505:210 (12 HP) × 90 × 58 mm

## Standards and directives

Type of protection	Connections and terminals: IP00 (EN 60730) Front in DIN cut-out: IP30 (EN 60730) IP30 (EN 60529), with accessory terminal cover
Energy class <sup>5)</sup>	I to VIII = up to 5% as per EU 811/2013, 2010/30/EU, 2009/125/EC
Environment class	3K3 (IEC 60721)
Protection class	I (EN 61140)
CE conformity according to	EMC Directive 2014/30/EU EN 61000-6-1 EN 61000-6-2 EN 61000-6-3 EN 61000-6-4
eu.bac certificate	Energy Performance of Buildings Directive 2010/31/EU EN 15500
eu.bac licence	No. 2166

## Overview of types

Type	COM1	COM2	COM3	Weight	Current consumption (max.)	Power consumption
EY-RC504F001	--	--	--	220 g	0.33 A	4 W / 8 VA
EY-RC504F101	--	--	--	220 g	0.33 A	4 W / 8 VA
EY-RC504F202	--	--	--	220 g	0.33 A	4 W / 8 VA
EY-RC504F011	KNX	--	--	240 g	0.33 A	4 W / 8 VA
EY-RC504F021	DALI	--	--	245 g	0.43 A	6 W / 10 VA
EY-RC504F041	SMI	--	--	240 g	0.33 A	4 W / 8 VA
EY-RC504F0C1	RS-485	--	--	243 g	0.33 A	5 W / 9.5 VA
EY-RC504F0D1	M-Bus	--	--	253 g	0.48 A	6.9 W / 10 VA
EY-RC505F031	KNX	DALI	--	385 g	0.61 A	7 W / 10 VA
EY-RC505F051	SMI	DALI	--	410 g	0.61 A	7 W / 11 VA
EY-RC505F061	KNX	SMI	--	385 g	0.33 A	4 W / 8 VA
EY-RC505F071	KNX	SMI	DALI	420 g	0.61 A	7 W / 11 VA
EY-RC505F081	--	DALI	DALI	410 g	0.61 A	9 W / 14 VA
EY-RC505F091	SMI	SMI	DALI	430 g	0.61 A	8 W / 12 VA
EY-RC505F0A1	KNX	DALI	DALI	420 g	0.61 A	9 W / 14 VA

<sup>4)</sup> M-Bus cable lengths depend on the cable type (J-Y(ST)Y 4 × 0.5 mm<sup>2</sup> up to 1000 m, LiYY 2 × 1.5 mm<sup>2</sup> up to 4000 m), the number of bus segments and the baud rate; see engineering notes

<sup>5)</sup> When the room automation station is being used as a temperature controller, most temperature controller classes can be fulfilled according to EU Directive 2010/30 / EU Regulation 811/2013. For information on the exact temperature class reached, please refer to the system integrator's user program

Type	COM1	COM2	COM3	Weight	Current consumption (max.)	Power consumption
EY-RC505F0B1	SMI	SMI	--	400 g	0.33 A	4 W / 8 VA
EY-RC505F0E1	RS-485	M-Bus	--	405 g	0.48 A	7.1 W / 10.6 VA
EY-RC505F0F1	RS-485	DALI	--	405 g	0.61 A	6 W / 10 VA
EY-RC505F0G1	RS-485	SMI	DALI	430 g	0.61 A	7 W / 10 VA
EY-RC505F0H1	KNX	RS-485	DALI	420 g	0.61 A	9 W / 14 VA
EY-RC505F0J1	RS-485	DALI	DALI	440 g	0.61 A	9 W / 14 VA

- 💡 *EY-RC 504, 505: Room automation station, 8 rooms/segments, 2 × SLC/RS-485*
- 💡 *COM1...3: Integrated communication interfaces*
- 💡 *F\*0\*: EY-RC504F001 (ecos504, standard), EY-RC504F101 (ecos504, moduWeb), EY-RC504F202 (ecos504-IoT, BACnet-MQTT gateway)*
- 💡 *DALI: DALI interface with bus power supply (116 mA)*
- 💡 *RS-485: RS-485 interface for Modbus/RTU and Modbus/ASCII*
- 💡 *SMI: SMI interface for SMI or SMI/LoVo*

#### Accessories

Type	Description
0940240001	ecos504/505 terminal covers (2 pcs)
0450573001	Transformer 230 V~ / 24 V=, 42 VA; for DIN rail 35 mm, dimensions: 78 × 74 × 52 mm (W×H×D)
EY-PS021F011	Power supply module 230 V~ / 24 V=, 1 A; 3 HP DIN rail mounting
EY-PS021F021	Power supply module 230 V~ / 24 V=, 2 A; 4 HP DIN rail mounting
EY-PS021F041	Power supply module 230 V~ / 24 V=, 4 A; 5 HP DIN rail mounting
EY-CM581F081	ecosCom581 EnOcean wireless interface
EY-RU 1**	ecoUnit 1 room operating units with EnOcean wireless technology (via EY-CM581F081)
EY-RU 3**	ecoUnit 3 room operating units (apart from EY-RU 38*)
EY-EM 51*	Remote ecoLink I/O modules (24 V)
EY-EM 52*	Remote ecoLink I/O modules (230 V)
YY-FX502F001	ecos-IoT: MQTT Client, licence for ecos504/505
YY-FX502F002	ecos-IoT: MQTT Client + Broker, licence for ecos504/505

- 💡 *1 HP = one horizontal pitch with 17.5 mm*

## Description of operation

The ecos 5 system family comprises a range of devices for room automation for the BACnet/IP system bus. The ecos504/505 room automation station (AS) is a modular, freely programmable BACnet Building Controller (B-BC) for the automation of up to eight rooms or flexible room segments with the functions room climate, lighting and sunshading.

The ecos504/505 as BACnet Building Controller (B-BC) can also be used as an individual AS for other functions in building automation (ventilation system unit, decentral data preparation for devices on a BACnet MS/TP line, central control of multiple VAV boxes etc.).

With the integrated web server, the ecos504 with moduWeb (EY-RC504F101) is also particularly suitable for small installations. The moduWeb supports comprehensive operation, direct visualisation of the data points, notification and forwarding of alarms and creation of time profiles (Scheduler).

With a function licence (YY-FX 502), the ecos504/505 with MQTT functionality can be used as a BACnet MQTT gateway for direct integration of MQTT-based IoT devices. ecos504 with integrated MQTT functionality (EY-RC504F202) can be used as an IoT gateway to connect the building automation network (OT: operational technology) with a public network (IT: information technology), a private cloud or public cloud. Authentication and encryption (TLS 1.2) are supported and can be configured.

The powerful programming environment, SAUTER CASE Suite, and the available function libraries allow both standard tasks of room automation and complex projects with flexible room division, based on room segments, to be carried out efficiently. Room operating units of the ecoUnit series, remote ecoLink I/O modules and EnOcean ecosCom581 wireless interfaces are connected to the ecos504/505 via RS-485 interfaces. The wireless interface can be used to integrate the SAUTER

EnOcean room operating units and ecoUnit 1 room sensors as well as other standard EnOcean devices.

A KNX interface (variants F011, F031, F061, F071, F0A1) allows the use of individual KNX components in the room, such as operating units, actuators or sensors, in order to cover special requirements.

A DALI interface with integrated DALI bus power supply (variants F021, F031, F051, F071, F091) enables the direct connection of DALI electronic ballasts (EB) and DALI sensors for integrated lighting control or regulation.

The variants with two DALI interfaces (F081, F0A1) can be operated individually as DALI bus 1 and DALI bus 2, each with a DALI bus power supply of max. 116 mA, or connected in parallel as a DALI bus with a DALI bus power supply of max. 232 mA.

One or two SMI interfaces (1x: F041, F051, F061, F071; 2x: F091, F0B1) each enable the activation of up to 16 SMI actuators (SMI (230 V) or SMI LoVo; a mix of SMI (230 V) and SMI LoVo on the same bus is not permitted) for simple, intelligent, precise sunshading functions for window blinds, roller shutters etc.

A half-duplex, 2-wire, electrically isolated RS-485 interface (variant F0C1) with the Modbus protocol as master (Modbus/RTU and Modbus/ASCII) enables the integration of up to 247 Modbus devices (Modbus slaves) such as multi-sensors, room operating units, energy meters (electricity, heat), intelligent actuators, communicative controllers etc.

An M-Bus/RS-232 interface with integrated physical M-Bus layer (variants F0D1, F0E1) can integrate as M-Bus master up to 40 M-Bus meters (unit loads) directly and/or up to 250 M-Bus meters with an additional external RS-232/M-Bus level converter.

---

#### Note



All information related to the operation of the web server is contained in the document "modu525 web operation" (manual 7010050001). More detailed information on BACnet functionality of the station can be found in the PICS documentation.

---

### Intended use

This product is only suitable for the purpose intended by the manufacturer, as described in the "Description of operation" section.

All related product regulations must also be adhered to. Changing or converting the product is not admissible.

### Engineering notes

The ecos504/505 is a modular device suitable for series installation (DIN 43880) on 35 mm DIN rails. The installation position can be chosen at will.

### Fitting and installation

---

#### Note



When fitted in an installation box or cabinet, it must be ensured that there is sufficient ventilation to allow the permissible operating temperature to be maintained.

---

The following conditions must be met or observed during the installation:

- Connection may only be performed when the system is disconnected from the electrical supply.
- The unit must be protected against contact.
- There must be an external primary isolating facility.
- There must be a connection of the protective earth to the relevant terminal.
- The connection to terminal MM may not be interrupted by switching elements.

Special standards such as IEC/EN 61508, IEC/EN 61511, IEC/EN 61131-1 and -2 and similar were not taken into account. Local requirements regarding installation, usage, access, access rights, accident prevention, safety, dismantling and disposal must be taken into account. Furthermore, the installation standards EN 50178, 50310, 50110, 50274, 61140 and similar must be observed.

The communication wiring (Ethernet, RS-485, KNX, M-Bus, RS-232) must be separated from current-carrying and live installations.

The communication wiring (DALI, SMI) can be routed with current-carrying and live installations (typically with electrical installation wire NYM 5x ...).

**DANGER**

Electric shock!

- ▶ The SMI and DALI buses are not SELV electrical circuits. The DALI and SMI bus cabling must be treated as 230 V.
- ▶ A mix of the two operating modes (230 V and LoVo) on one SMI bus is not permitted.

For further safety instructions, information and guidelines, see fitting instructions P100002325.

**Installation in small distribution boxes**

The ecos504/505 is suitable for fitting in standard small distribution boxes using DIN rail housing. The small distribution boxes are available in variants for surface mounting and flush mounting from various manufacturers of electrical installation equipment. This allows the ecos504/505 to be used simply and cheaply for all kinds of installation requirements, e.g.:

- Decentralised surface mounting for false ceilings or double floors
- Recessed mounting in small distribution boxes for hotel rooms or floor distributors together with automatic fuses, power supply modules, power contactors etc.
- Fitting with protection against dust and splashing (IP40...IP65) with suitable small distribution boxes and cable glands

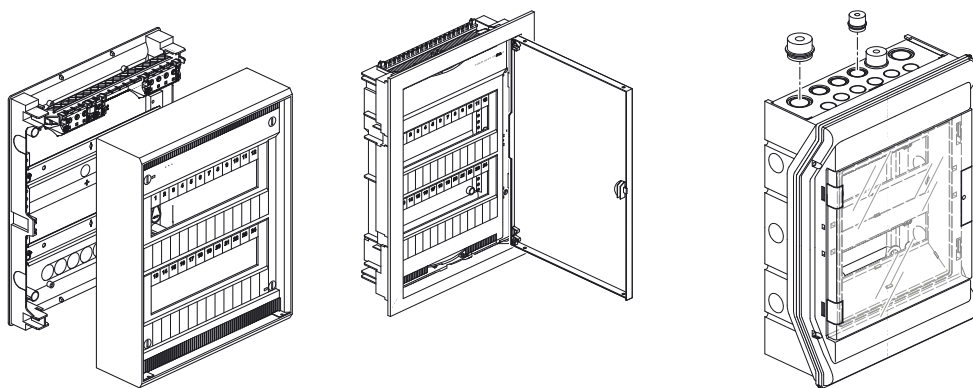
**Terminal cover**

The terminal cover (0940240001) is intended for proper connection of the supply and control lines with a cable fastener in the case of wall mounting if no surrounding housing is required. When the cover is in place, the terminal cover together with ecos504/505 guarantees IP30 protection. Two terminal covers (0940230001) are required for ecos505.

EY-RC 504

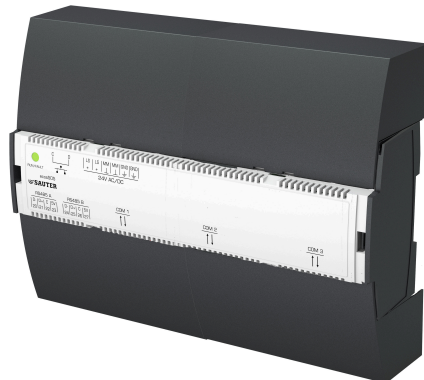

EY-RC 505

**Power supply**

The device is suitable for operation at 24 V~ or 24 V=. Operation with 24 V= power supply modules (EY-PS 021) is recommended, as these are optimally matched to the ecos504/505. DC operation causes the lowest power loss and heat development, which increases the service life and minimises the devices' power consumption.

The power supply connection is equipped with double terminals, allowing it to be looped through to other devices. The maximum ampacity of the connection terminals must be complied with; to this end,



external fuse protection is essential in all cases. When a current-limiting power supply unit is used, such as EY-PS 021, fuse protection in the 24 V electrical circuit is not necessary. The fuse required for the primary electrical circuit on the power supply unit can be found in the manufacturer's instructions.

For the sizing of a DC power supply, the maximum current consumption of the ecos504/505 and all other devices attached to the 24 V supply is added up. The next-largest power supply module is selected; a reserve of at least 15% is to be taken into account.

The earth connector  on the ecos504/505 is the protective earth and must always be suitably connected to the earth for safety and EMC reasons.

#### Note









Some field devices (e.g. AXS continuous thermal actuator) and the remote ecoLink510, 511, 512\* I/O modules require a 24 V~ AC power supply. The remote ecoLink514, 515 I/O modules can also be supplied with 24 V= (DC power supply). This is to be taken into consideration during engineering.

For the operation of the ecos504/505 with 24 V~, the transformer listed in the accessories must be used. If greater power is required, safety transformers of a good industrial quality with SELV or PELV outputs can be used. The output voltage must always lie within the specified input voltage range of the ecos504/505, taking into account the full tolerance range of the mains power supply (230 V  $\pm 10\%$ ). For the dimensioning of the transformer, a reserve of at least 15 VA is to be included in order to take into account the pulse-like current consumption of the connected devices.

### Run/fault LED indicator

The operating status of the device is indicated by the RUN/FAULT LED.

RUN/FAULT	Indicator sequence	Description
Continuous green		Normal mode
Flashing green		Identification via CASE Sun
Continuous orange		In startup mode
Flashing orange		The internal backup battery must be replaced
Continuous red		No CASE Engine plan in ecos
Flashing red		Program download or configuration active
Red flashing rapidly		Internal device error

### Programming/configuration/initialisation

The ecos504/505 room automation station is freely programmable. The complete user program (CASE Engine plan), and the parameterisation of the ecos (BACnet objects, images for moduWeb, etc.) and of the devices connected via the interfaces of the ecos504/505, are set up using CASE Suite. In this user program, the inputs and outputs are linked and the required control and regulation tasks are carried out.

The user program can be loaded from any point in the IP network with CASE Suite. Flashing red LED indicators show that there is an active download. The user program and the parameterisation are permanently saved in the ecos in a flash module and are retained even if there is a power failure.

Every AS must be configured for communication in an Ethernet network. All settings such as IP address, subnet mask, gateway and instance number (DOI), as well as additional properties such as host name and location, are parameterised via CASE Suite. The devices are delivered with DHCP mode (Zeroconf) as the factory setting. CASE Suite can also be used to activate the function licence for MQTT on the ecos504/505 station.

In order to be able to identify the AS in a network visually, the CASE Sun commissioning tool can be used to put the run/fault LED in flashing mode.

An initialisation of the AS can be carried out before the download with CASE Suite.



## Firmware

The AS is delivered with a current version of the firmware. At the time of commissioning, a newer firmware version may be available. Before commissioning an AS, it is therefore necessary to check the firmware version and, if required, perform an update with CASE Sun via the network and for the COM modules via CASE Engine.

## RTC (Real Time Clock)

A Real Time Clock (RTC) is integrated into the ecos504/505 for the time programmes (schedulers/calendars). The date, time and time zone are set in the AS when loading the user parameters. The BACnet services "DM-TS-B" and "DM-UTC-B" are used to synchronise the time and date automatically if a BACnet time master is specified accordingly (e.g. SAUTER Vision Center, moduWeb Vision, modu525). The time, date and time zone can be set manually, for example using the BACnet browser or with the integrated moduWeb web server (only F101).

The summer time setting (daylight saving) is activated in the network properties of the AS (CASE Engine) by default and includes all the AS integrated into the same network.

A lithium button-cell of the type CR2032 in the device ensures that in the event of a power failure the Real Time Clock is retained. The battery is designed for a serviceable life of approx. 10 years. High storage or transportation temperatures can significantly reduce the capacity of the battery. The user parameters from CASE Engine and the user data (e.g. modified by BACnet client) are permanently stored in the flash memory and are battery-independent.

---

### Note



The battery is to be replaced by a qualified electrician only!

---

## Data recording

The BACnet functionality can be used to create Trend Log objects (data points). The recording can be defined either periodically (time interval) or by means of a grid threshold (COV).

With the integrated moduWeb web server (only F101), data points can be recorded periodically at intervals of one minute independently of trend objects.

---

### Note



Trend Log objects are not permanently saved. If the power supply is interrupted, the data of the objects is deleted. We recommend regular data back-up for the Trend Log objects by the building management system (e.g. SAUTER Vision Center).

---

## Time programmes, calendar

The BACnet functionality allows BACnet time programmes (Scheduler) and calendar objects (Calendar) to be created in the ecos504/505. The time or calendar objects can be displayed, operated or adjusted with a BACnet client (e.g. SAUTER Vision Center) or the integrated moduWeb web server (only F101).

## Behaviour when the power supply fails

Power failures lead to an orderly shut-down of the ecos504/505 and, once the power supply is restored, to an automatic and orderly restart. The AS automatically re-establishes communication via BACnet, RS-485/SLC, KNX, DALI, SMI, RS-485/Modbus and M-Bus.

For BACnet objects, this means:

- The "Notification Class Recipient List" remains and the clients still automatically receive the event and alarm information without logging in again
- One's own COV messages remain
- The COV subscriptions on other stations are logged in again automatically
- Connections between room automation stations (AS-AS) are updated again (re-subscription)

## RS-485 A, RS-485 B interfaces

The RS-485 A and B interfaces are for connecting remote I/O modules from the ecoLink family as well as room operating units of the ecoUnit 3 series (EY-RU 31\*/34\*/35\*/36\*). Either one or two EnOcean ecosCom581 (EY-CM 581) wireless interfaces can still be connected to integrate each

room operating unit of the ecoUnit 1 (EY-RU 1\*\*) series and other EnOcean devices. This means that the I/O mix of the ecos can be optimally adapted to the project requirements.







The max. admissible bus length depends on the cable type used and the correct termination with terminating resistors. In general, a 4-wire shielded cable with twisted wire pairs must be used. Observe the correct polarity of all signals. The cable shield of the entire bus line must be connected continuously, and connected to protective earth as directly as possible at one location. The length of the line may not exceed 8 cm for optimum resistance to interference.

For Ethernet CAT 5 cables and J-Y(ST)Y cables, the possible bus length is up to 500 m. The bus length is reduced when the EY-CM 581 wireless interface or EY-RU 3\*\* room operating units are connected (see connection plans). In the case of RS-485 interfaces, the bus wiring must follow line topology. Star, tree or branch topologies are not recommended. The devices do not have internal terminating resistors. Therefore, a terminating resistor of 120 Ω (0.25 W) must be connected at the start and end of the bus line, parallel to the D+/D- data lines.

Room operating units EY-RU 31\* and 34\* with EY-SU 306 and EY-RU 35\* with EY-SU 35\* and the EY-CM 581 wireless interface are supplied directly from the 5 V power supply of the RS-485 A or RS-485 B interfaces. The sum of all load currents of the connected devices of both interfaces may not exceed the max. permissible current of 200 mA. Furthermore, it must be ensured that there is a sufficient cable cross-section (= 0.5 mm<sup>2</sup>) to limit the voltage drop across the power cable to max. 1.2 V.

The EY-RU 35\* with EY-SU 35\* and the EY-RU 36\* can only use the D+/D- data lines of SLC/RS-485. The devices must then be supplied by an external power supply (24 V=). It is recommended to connect them to the power supply of the controller so that the devices have a common reference (common ground).

#### RS-485 A, RS-485 B LED indicators

RS-485 A, RS-485 B	Indicator sequence	Description
Continuous green		OK
Flashing green		Network traffic
Continuous orange		Start-up phase; communication is being set up
Continuous red		Not used
Flashing red		Communication error (e.g. ecoLink not connected)
OFF		Interface not used, no communication

#### Integration of ecoLink and other SLC devices via SAUTER CASE Suite

The ecoLink modules and other SAUTER SLC devices are engineered using CASE Engine. If the ecos AS is engineered as a group station with individual segment plans, the inputs and outputs of the ecoLink modules can be freely assigned to the individual functions in the segment plans. The user has maximum freedom. The ecoLink modules are engineered and device addresses are issued to this end. Data points are then defined in CASE Engine and assigned to the relevant modules with their channel connections. This allows the inputs and outputs to be mapped directly to BACnet data points.

In contrast to this, in the case of identical room segments, both the function and the allocation of the inputs and outputs are identical for all room segments. The inputs and outputs are then correspondingly “mirrored”, i.e. repeated. In the case of engineering with identical room segments, this means that each complete ecoLink module is assigned to a certain room segment and cannot be divided among several. An additional description of the benefits and disadvantages or optimum working technique can be found in the engineering guideline for room automation.

Below you will find possible configurations of the ecos504/505 for engineering with 1, 2, 4 and 8 identical room segments, as well as the mirroring and addressing of the ecoLink and other SLC device addresses (ecoUnit, ASV, FCCP 2). For engineering with individual room segments, mirroring is not required. The data points can then be freely assigned for the ecoLink modules.

#### Note



A maximum of 12 SLC devices can be connected to each RS-485 interface.

**1 segment per ecos or individual station:**

Interface	RS-485 A	RS-485 B
Segment	Seg 1	
ecoUnit/FCCP 2 address	1, 2, 3, 4	1, 2, 3, 4
ecoLink address	1, 2, 9, 10, 17, 18, 25, 26	1, 2, 9, 10, 17, 18, 25, 26
ASV address	100...111	100...111

**Mirroring type RS-485 A**

If mirroring type "RS-485 A" is selected, 2 or 4 room segments are possible. The RS-485 B bus can then only be used with individual segment plans.

Configuration	2 segments	
Interface	RS-485 A	
Segment	Seg 1	Seg 2
ecoUnit/FCCP 2 address	1, 3	2, 4
ecoLink address	1, 2, 9, 10	17, 18, 25, 26
ASV address	100...103, 108, 110	104...107, 109, 111

Configuration	4 segments			
Interface	RS-485 A			
Segment	Seg 1	Seg 2	Seg 3	Seg 4
ecoUnit/FCCP 2 address	1	2	3	4
ecoLink address	1, 2	9, 10	17, 18	25, 26
ASV address	100, 101, 108	102, 103, 109	104, 105, 110	106, 107, 111

**Mirroring type RS-485 A / RS-485 B:**

If mirroring type "RS-485 A / RS-485 B" is selected, 2, 4 or 8 room segments are possible.

Configuration	2 segments	
Interface	RS-485 A	RS-485 B
Segment	Seg 1	Seg 2
ecoUnit/FCCP 2 address	1, 2, 3, 4	1, 2, 3, 4
ecoLink address	1, 2, 9, 10, 17, 18, 25, 26	1, 2, 9, 10, 17, 18, 25, 26
ASV address	100...111	100...111

Configuration	4 segments			
Interface	RS-485 A		RS-485 B	
Segment	Seg 1	Seg 2	Seg 3	Seg 4
ecoUnit/FCCP 2 address	1, 3	2, 4	1, 3	2, 4
ecoLink address	1, 2, 9, 10	17, 18, 25, 26	1, 2, 9, 10	17, 18, 25, 26
ASV address	100...103, 108, 110	104...107, 109, 111	100...103, 108, 110	104...107, 109, 111

Configuration	8 segments							
Interface	RS-485 A				RS-485 B			
Segment	Seg 1	Seg 2	Seg 3	Seg 4	Seg 5	Seg 6	Seg 7	Seg 8
ecoUnit/FCCP 2 address	1	2	3	4	1	2	3	4
ecoLink address	1, 2	9, 10	17, 18	25, 26	1, 2	9, 10	17, 18	25, 26
ASV address	100, 101, 108	102, 103, 109	104, 105, 110	106, 107, 111	100, 101, 108	102, 103, 109	104, 105, 110	106, 107, 111

### Start-up behaviour / monitoring function

The communication between ecos and the engineered ecoLink modules at the RS-485 buses is monitored. If the communication fails for more than the monitoring time of 10s, the affected ecoLink modules switch to the safety status. The data points in the ecos are marked with the status "unreliable". All outputs of the affected ecoLink modules are switched to the defined value for the safety state ("relinquish default").

Equally, engineered room operating units are monitored; the status of the devices is shown by means of corresponding "valid" outputs on the ROOM\_UNIT block in CASE Engine.

Details on start-up behaviour and monitoring functions can be found in the documentation of the peripheral devices in question.

### KNX interface

The KNX interface enables direct integration of KNX devices into BACnet/IP automation at room level. The KNX devices (e.g. operating units, actuators or sensors) are engineered in CASE Engine. The KNX data points are mapped to the CASE Engine input or output objects. This allows KNX data points to be used in the free programming of regulation and logic functions with CASE Engine, like any other input or output objects. Here all KNX devices communicate with the ecos. Using the function for individual segment plans in CASE Engine, KNX data points can also be integrated into the concept of flexible room division with room segments and AS groups.

For commissioning, the engineered KNX data points are exported from CASE Engine with the determined group addresses and are imported into the ETS KNX configuration tool. A three-level group address structure is a prerequisite for this. With ETS, the KNX devices are then selected from the database and the existing data point objects are assigned to the imported list of group addresses. Furthermore, ETS can be used to configure and parameterise the KNX devices.

Connecting KNX devices to one another using ETS is not necessary and would be disadvantageous as all logic connections and regulation functions are contained in the CASE Engine program for a better overview and greater flexibility.

The KNX network is thus a local field bus within the rooms or room segments that are regulated by an ecos504/505 device. KNX line and area couplers may no longer be necessary with this BACnet topology. This means that many KNX bus segments can exist in a building. For simple commissioning and maintenance, access can be made directly to all KNX segments from the shared BACnet/IP (Ethernet). The work station with CASE Engine and the ETS KNX configuration tool is connected with the Ethernet network; the KNX communication is then tunnelled through the Ethernet and ecos504/505 to the selected local KNX network.

This means that it is not necessary to be connected locally to every individual KNX segment. From ecos504/505 firmware V2.8.3 and KNX firmware V1.1.4 upwards, the KNX tunnelling function for ETS is supported directly on ecos504/505, which means that no external KNX interface is required for the commissioning of KNX devices.

In addition to ecos504/505 and the KNX field devices, a KNX power supply module is needed, as shown in the connection diagram.

All KNX devices can be used with the ecos KNX. However, the following must be considered:

- Supported KNX data point type (DPT) – see table
- Design of the external KNX bus power supply
- Number of KNX group addresses to be used with the corresponding external KNX group communication objects

### BACnet mapping

All standard BACnet input/output objects can be used with KNX group addresses.





BACnet objects	Type	Description
BO, BI	1-bit	Binary output, binary input
AO, AI	32-bit float	Analogue output, analogue input
MO, MI	32-bit UInt	Multi-state output, multi-state input (values: 1...8)
PC	32-bit UInt	Pulse Converter (reading only as input, to Present Value)

### Supported KNX functions

KNX Data Point Type	Type	Description
DPT 1.* , 2.*	1-bit / 2-bit	1-bit, 1-bit controlled
DPT 3.*	3-bit	3-bit controlled (mapping on AI/AO (0...15) or MI/MO with three states)
DPT 4.*	8-bit	Character set <sup>6)</sup>
DPT 5.* , 6.*	8-bit UInt	8-bit without sign, 8-bit with sign
DPT 7.* , 8.* , 9.*	2-byte (16-bit)	2-byte without sign, 2-byte with sign, 2-byte floating point number
DPT 12.* , 13.* , 14.*	4-byte (32-bit)	2-byte without sign, 2-byte with sign, 2-byte floating point number
DPT 17.* , 18.*	1-byte (8-bit)	KNX scene number and scene control <sup>7)</sup>

With KNX firmware version 1.1.7, DPT 10.\* (time), 11.\* (date) and 19.\* (time and date) can be given KNX group addresses as system parameters, so that KNX devices on these group addresses can be “synchronised” with the current BACnet time and date of the ecos504/505.

### KNX LED indicator

KNX	Indicator sequence	Description
Continuous green		OK
Flashing green		Network traffic
Continuous orange		Start-up phase; communication is being set up
Flashing red		Communication fault

### DALI interface with integrated DALI bus power supply

The DALI interface enables direct integration of DALI electronic ballasts (EB) and DALI sensors into the BACnet/IP automation at room level. The DALI interface is a DALI single application master with integrated DALI bus power supply as per IEC 62386-101 and -103.

The DALI devices (e.g. ballasts, switching outputs, sensors) are engineered in CASE Engine. The DALI data points and functions are mapped to the CASE Engine input and output objects. This allows DALI data points to be used in the free programming of regulation and logic functions with CASE Engine, like any other input or output objects. Here all DALI devices communicate as DALI slaves with the ecos as DALI master. Using the function for individual segment plans in CASE Engine, DALI data points can also be integrated into the concept of flexible room division with room segments and AS groups. For commissioning, the engineered DALI data points, with the defined DALI short addresses and DALI group addresses, are exported from CASE Engine and are imported accordingly with the integrated, web-based ecos-DALI commissioning tool (ecos-DALI-COT). Thus, the engineered DALI addresses with their corresponding installation location can be assigned to the actually installed devices. The related DALI parameters are also loaded onto the DALI devices in this way.

The ecos-DALI-COT supports the following:

- (Group) addressing of the ballasts and addressing of the sensors
- Configuration of the DALI sensors as slaves
- Configuration of the ballasts for optimised dimming

When the ecos-DALI-COT is used, no further settings are required for the DALI devices.

Connecting DALI devices directly to each other (sensor to ballast) is not necessary and would be disadvantageous as all logic connections and regulation functions are contained in the CASE Engine program for a better overview and greater flexibility.

The DALI network is thus a local field bus for the lighting within the rooms or room segments that are regulated by an ecos504/505 device. This means that many DALI bus segments can exist in a building. For simple commissioning and maintenance, access can be made directly to all DALI segments from the shared BACnet/IP (Ethernet). The work station with CASE Engine and a web browser for the ecos-DALI-COT is connected with the Ethernet network and the corresponding IP

<sup>6)</sup> Mappings for corresponding BACnet I/O objects are not recommended or are not possible

<sup>7)</sup> Mappings for corresponding BACnet I/O objects are not recommended or are not possible

address of the ecos504/505. This means that it is not necessary to be connected locally to every individual DALI segment.

The ecos504/505 with the DALI module has an integrated DALI bus power supply (up to 116 mA). As shown in the connection diagram, individual use of the DALI modules (each up to 116 mA, each 1 × 64 ballasts, 1 × 64 sensors) or the parallel connection of 2 DALI modules (up to 232 mA, each 64 ballasts and each 64 sensors) is possible. When the two DALI modules are connected in parallel for increased bus power supply, only 1 × 64 DALI ballasts and up to 1 × 64 sensors can be used. In this case, the 2nd interface only serves as the DALI bus power supply. The internal DALI bus power supply can also be switched off via CASE or ecos-DALI-COT in order to use an external DALI power supply module. Note that all power supplies connected to the bus must not supply a combined total of more than 250 mA. The internal DALI bus power supply has short-circuit monitoring as per IEC 62386-101 (section 6.6.2). Therefore, when operating simultaneously with an internal and an external power supply, the external power supply must not have short-circuit switch-off.

DALI devices according to IEC 62386-102 and -103 can be used with the ecos DALI. The following must be considered:

- Supported DALI functions (see table)
- No support for DALI additional functions as per IEC 62386-2xx
- DALI basic functions for DALI switching output (DT7) as per IEC 62386-208 and DALI colour control (DT8) as per IEC 62386-209 are supported by ecos DALI firmware version 2 and higher
- DALI 2 sensors as per IEC 62386-103 and -30x are supported by ecos DALI firmware version 2 and higher. They must be queried in slave mode via polling. No support of event-controlled sensor messages
- Design of the DALI bus power supply
- Number of DALI addresses and functions to be used
- Consideration of the bus bandwidth via optimum settings for the DALI master functions (query intervals, priority, etc.)

#### Supported DALI functions, BACnet mapping

All standard BACnet input/output objects can be used with DALI device addresses and group addresses or as broadcast.

BACnet objects	Type	Description
BO, BI	1-bit	Binary output, binary input
AO, AI	32-bit float	Analogue output, analogue input
MO, MI	32-bit UInt	Multi-state output, multi-state input (values: 1...8)
LO	32-bit float	Lighting output
DIM_O	Pulse/float	Dimming output
PIV(I/O)	32-bit UInt	Positive Integer Value

#### DALI (during operation - online)

CASE Engine / ecos firmware support the following DALI functions (online):

Function - write	DALI commands	Description
DIM lamp (SOFT OFF)	DAPC (level)	Dimming of DALI ballasts or groups with a FadeTime of 0.7 seconds
DIM lamp (QUICK OFF)	DAPC (level) / OFF	Dimming of DALI ballasts or groups with a FadeTime of 0.7 seconds, with quick OFF command
Lamp ON/OFF	OFF/RECALL MAX LEVEL	Fast switching on/off of DALI ballasts or groups
Lamp GOTO SCENE	GOTO SCENE	Command execution of "Goto scene 0...15"
Lamp STEP UP/DOWN	IAPC UP/DOWN	Dimming up or down step-by-step
Lamp FADE	FADE UP/DOWN	Control for manual lamp dimming. Fade Up / Fade Down in 200 milliseconds with fade rate (step/second). 1: Neutral; 2: On + StepUp; 3: Min; 4: FadeUp; 5: Fade-Down; 6: Max; 7: Off
Switching output ON/OFF	DAPC (0/254)	Switching of a DALI switching output (DT7 as per -208)
SET switching output with hysteresis	DAPC (0...54)	Switching of a DALI switching output with switching hystereses (DT7 as per -208)

Function - write	DALI commands	Description
Lamp COOLER/WARMER	IAPC UP/DOWN	Cooler or warmer colour temperature in steps of 5 Mirek (DT8 as per -209). 1: Neutral, 2: Cooler, 3: Warmer
Lamp GOTO colour temperature (°K)	DAPC	Setting of the colour temperature (DT8 as per -209). 1...1 000 000
Lamp GOTO RGB [Hue]	DAPC	Setting of the RGB colour (DT8 as per -209). Hue colour: 0...359 (red...magenta), 360 (white). The saturation and light strength cannot be adjusted
Lamp GOTO RGBW [HueW]	DAPC	Setting of the RGBW colour (DT8 as per -209). RGBW colour = HUE + (360 × WHITE); where HUE = 0...359 (red...magenta) and WHITE = 0...254





Function - read	DALI commands	Description
Status of ballast	QUERY STATUS	Periodic querying of the 8-bit status value of the lamp; 0...255 as per DALI standard -102, 9.16.1
Status of ballast (MS)	QUERY STATUS	Return value for BACnet multi-state: 1: OK 2: Lamp error 3: Ballast error 4: Ballast and lamp error
Status of lamp (ON/OFF)	QUERY LAMP POWER ON	Status of a lamp (ON/OFF)
Status of lamp brightness (%)	QUERY ACTUAL LEVEL	Current brightness value of a lamp
Status of switching output	QUERY STATUS	Status of the switching output 0 or 1 (DT7 as per -208)
Status of lamp temperature (°K)	QUERY ACTUAL LEVEL	Reading of the current colour temperature (DT8 as per -209). 1...1 000 000
Status of lamp colour RGB [Hue]	QUERY ACTUAL LEVEL	Reading of the current Hue colour
Status of lamp colour RGBW [HueW]	QUERY ACTUAL LEVEL	Reading of the current Hue colour and white light strength
Status of DALI sensors	Various	Reading of: <ul style="list-style-type: none"> <li>• Sensor value (lux, temp. 0...1023/4095/65535)</li> <li>• Presence value (0 or 1)</li> <li>• Movement (1: free/still, 2: free/movement, 3: presence/still, 4: presence/movement)</li> </ul>
Status 16-bit	QUERY 16-bit	General 16-bit query as per -102 with op code 157...196
Status 24-bit	QUERY 24-bit	General 24-bit query as per -103 with op code 48...72, 128...146

### DALI (configuration)

The ecos-DALI commissioning tool (COT) supports various DALI functions (config). The most important ones:

Function	DALI commands	Description
Set DALI device address	SET SHORT ADDRESS	Short address assignment for all DALI devices in the DALI network
Search for DALI devices	QUERY RANDOM	Search for all connected devices
Assign DALI groups	ADD TO GROUP	Assignment of the DALI groups as per CASE assignment table
Identify DALI devices	RECALL MAX LEVEL	Flashing of individual lamps to identify a device

### DALI LED indicator

DALI	Indicator sequence	Description
Continuous green		OK (all data points OK, no bus traffic)
Flashing green		OK (active bus traffic)
Continuous orange		Start-up phase; communication is being set up
Continuous red		DALI bus supply error (no supply - short circuit or 230 V~ on bus)
Flashing red		Communication error (at least one data point cannot set up correct communication with the DALI device)



### Supported DALI devices

DALI products from qualified DALI product manufacturers are supported with the ecos-DALI. In a compatibility list, these products can be published after a successful integration test. During the engineering, it can be assumed that both DALI (version 1) and DALI-2 devices comply with the standard and can be integrated.

Along with IEC 62386-102, ecos-DALI supports the following device type profiles:

- -201: Fluorescent tubes (device type 0)
- -204: Low-voltage halogen lamps (device type 3)
- -205: Power supply controller for light bulbs (device type 4)
- -207: LED modules (device type 6)
- -208: Switching function (device type 7)
- -209: Colour/colour temperature control (device type 8, with “tunable white” Tc and “colour control” RGBW(AF))

---

#### Note



Only DALI functions as per IEC 62386-102 (“basic functions”) and no additional functions from IEC 62386-2xx (“specific functions for DALI device type”) are supported by the ecos-DALI firmware V1 and V2.

---

Along with IEC 62386-103, ecos-DALI supports the following DALI sensors:

- Proprietary DALI sensors (see compatibility list)
- DALI-2 sensors as per IEC 62386-103 (-303 and -304)

---

#### Note



DALI-2 input device events are not supported and must be integrated with polling. If the standard setting of the DALI-2 sensors does not match the ecos-DALI, the DALI-2 sensors must be configured with a DALI tool (deactivation of instances, change to slave mode, set timers etc.).

---

Possible manufacturers:

- DALI ballast devices (DT0, 3, 4, 6): BAG, Helvar, Meanwell, Lunatone, OSRAM, Philips, Tridonic, TCI, Vossloh-Schwabe
- DALI switching outputs (DT7): ESYLUX, Loytec, Lunatone, OSRAM, Tridonic
- DALI colour control (DT8): Hadler, Helvar, Lunatone, Tridonic
- DALI sensors (proprietary): Loytec, Lunatone, OSRAM, ThebenHTS
- DALI sensors (proprietary)<sup>8)</sup>: Helvar, Tridonic
- DALI-2 sensors<sup>9)</sup>: B.E.G., Calon, ESYLUX, Loytec, Lunatone, Niko, Steinell, ThebenHTS, Tridonic.

Detailed information on the supported devices of all manufacturers is provided in the ecos-DALI compatibility list (D100317613).

### SMI interface as SMI actuator

The SMI interface of the ecos504/505 serves as an SMI activator for controlling SMI actuators. It enables the direct integration, configuration and activation of up to 16 SMI actuators connected to the SMI bus. The activation of the motors can be carried out with CASE Engine and the corresponding BACnet input and output objects and can be combined with regulation and logic functions using the free programming of CASE Engine. Groups can be formed in order to activate SMI actuators as a complete group. Using the function for individual segment plans in CASE Engine, individual SMI actuators can also be integrated into the concept of flexible room division with room segments and AS groups.

The “SMI-easyMonitor” (download from [www.standard-motor-interface.com](http://www.standard-motor-interface.com)) is required for the commissioning and addressing of the SMI actuators. The tool can use a virtual serial port to access the SMI bus directly via ecos504/505 (“tunnelling”) and perform the addressing of the SMI actuators. No USB-SMI converter is required. The configuration of the end stops of the individual hangings (window blinds, roller shutters, etc.) must be carried out on site directly on the motors using the individual setting tools to be obtained from the respective manufacturer. The commissioning via SMI-

---

<sup>8)</sup> These proprietary DALI sensors must be addressed and configured using the manufacturer tool

<sup>9)</sup> Configuring the DALI-2 sensors is not yet completely supported with the ecos-DALI-COT (as of: ecos firmware V3.5)

easyMonitor should be carried out first. The parallel operation of SMI-easyMonitor and the ecos program for activating SMI motors is not supported. The adjustment of the position and angle of the hangings (e.g. window blinds/slats) can be carried out individually using the CASE Engine plan. All SMI actuators can be used with ecos-SMI (see ecos-SMI compatibility list). ecos-SMI supports the following SMI functions:

### Supported SMI functions, BACnet mapping

Standard BACnet input/output objects, as well as the "Blind-Out2" BACnet object (BLND\_O2), can use the SMI functions with a device/group or broadcast address.

BACnet objects	Type	Description
BO, BI	1-bit	Binary output, binary input
AO, AI	32-bit float	Analogue output, analogue input
MO, MI	32-bit UInt	Multi-state output, multi-state input (values 1...8)
BLND_O2 <sup>10)</sup>	Special type ("Motor Drive")	Output object for window blind, roller shutters etc. with integrated function: <ul style="list-style-type: none"> <li>• pulse up/down</li> <li>• "Go To" for position and angle</li> <li>• Multistate for neutral, open, closed, open pulse, closed pulse, stop</li> </ul>

### SMI (during operation – online)

CASE Engine / ecos firmware support the following SMI functions (online)

SMI function, command/write	BACnet object	Description
Up(1)/Stop(0)	BO	Command to move up
Down(1)/Stop(0)	BO	Command to move down
Neutral(0)/Stop(1)	BO	Command to stop
Neutral(1)/Up(2)/Down(3)/Up pulse(4)/Down pulse(5)/Stop(6)	BLND_O2	Movement command
Go to motor position (%)	AO, (MO)	Move to position
Go to motor position (%) and angle	BLND_O2	Movement command
Neutral(1)/Up(2)/Down(3)/Stop(4)	MO, (AO)	Movement command
Step up (°)	AO, (MO)	Movement command in steps (incremental, 0...510°)
Step down (°)	AO, (MO)	Movement command in steps (incremental, 0...510°)
Go to PRESET position	MO, (AO)	Movement command to go to PRESET positions: 1: Neutral 2: To position 1 3: To position 2 4: Stop
Write PRESET 1 (%)	AO, (MO)	Write PRESET position 1
Write PRESET position 2 (%)	AO, (MO)	Write PRESET position 2





SMI function, feedback/read	BACnet object	Description
Query motor in top end position	BI	Top end position reached: All actuators in end position = 1
Query motor in bottom end position	BI	Bottom end position reached: All actuators in end position = 1
Query motor error	BI	Motor error: OK = 0 Error = 1
Query motor position (%)	AI	Current motor position
Query movement status	MI	All stop (1) Motor(s) moving up (2) Motor(s) moving down (3) Motor(s) moving up and down (4)
Query motor position (%) and angle	BLND_O2	Current motor position and current angle
Query motor status (DrvSt)	BLND_O2	Current motor status (0: --, 1: Neutral, 2: Up, 3: Down)

<sup>10)</sup> This function is supported from firmware version ecos V3.2 and ecos-SMI V1.7.1 and higher

**Note**

When SMI commands are executed (e.g. lower window blind), the command to be currently carried out must be completed before a subsequent command can be sent to the motor. Each new command stops a previous command that has not been completed. When SMI commands for up to 16 actuators are being executed and simultaneously the moving status is being read back, increased bus traffic can cause delays in the command execution of around 200 to 700 milliseconds.

**SMI LED indicator**

SMI:	Indicator sequence	Description
Continuous green		OK (all data points OK, no bus traffic, no plan, empty plan (without SMI data points))
Flashing green		OK (active bus traffic)
Continuous orange		Start-up phase; communication is being set up
Continuous red		SMI bus error (supply error, short circuit or 230 V~ detected in bus during start-up)
Flashing red		Communication error (at least one data point cannot set up correct communication with the SMI actuator)

**Supported SMI actuators**

SMI actuators from qualified SMI product manufacturers are supported by the ecos-SMI. These products can be published in a compatibility list after a successful integration test or successful use in a project. During engineering it can be assumed that all certified SMI actuators comply with the standard and can be integrated.

Possible manufacturers are: Becker, Dunker, Elero, Geiger, Selve, Vestamatic.

Supported and tested devices are listed in the ecos-SMI compatibility list (D100370158).

**RS-485 interface for Modbus**

The RS-485 interface for Modbus (master) enables direct integration of Modbus devices (slaves) into the BACnet/IP automation at room level, from CASE Suite 3.10. The Modbus devices (e.g. operating units, meters, actuators or sensors) are engineered in CASE Engine. The Modbus data points are mapped to the CASE Engine input, output or value objects. This allows Modbus data points, like all other objects, to be used in the free programming of regulation and logic functions with CASE Engine. Here the ecos communicates with all Modbus devices. Using the function for individual segment plans in CASE Engine, Modbus data points can also be integrated into the concept of flexible room division with room segments and AS groups. The Modbus network is thus a local field bus within the rooms or room segments.

The RS-485 network for field bus protocols must be implemented as per ANSI/TIA/EIA-485-A [half duplex (D+/D-), electrically isolated (COM reference), network resistors with Pull-Up (PU), Pull-Down (PD), line-end resistors (LT: line termination)]. With the Modbus module configuration, the resistors can be added or removed using software. It is recommended to use a shielded, twisted cable (1×2+1-wire, 2×2-wire) specifically for RS-485. It is also possible to use J-Y(ST)Y cables taking into account the cable impedance of 100...120 Ω and sufficient diameter (0.8 mm or 0.5 mm<sup>2</sup>). The cables must be installed as a line topology and the shielding must be continuously connected to the earth at one location. The maximum cable length is 1000 m. The baud rate can be 600 up to 115,200 bit/s. As master, the Modbus module also supports different communication parameters simultaneously (e.g. baud rates, device timings, Modbus mode RTU/ASCII).

Before the commissioning, the Modbus devices and their supported functions must be estimated and the devices addressed and configured. The supported functions are then parameterised in CASE Engine. The Modbus master function is configured in the module configuration, the individual specific device parameters in the device table and the Modbus function ("function code") in the BACnet I/O/V modules. For easy commissioning and maintenance, a virtual serial port can be activated on the ecos so that the usual Modbus master tools can connect directly, without additional RS-485 converters, via IP/Ethernet with the Modbus devices.

All Modbus devices with RS-485 can be used with the ecos Modbus. However, the following must be considered:

- Supported Modbus function codes

- Supported Modbus data types
- Number of data points, max. 600
- Number of devices, max. 247 (logical) or 31 unit loads
- Device communication parameters: Baud rate, RTU/ASCII, COM error, timings, max. access size etc.

### BACnet mapping

Standard BACnet input/output objects and the Positive Integer Value object can be used with Modbus.

BACnet objects	Type	Description
BO (PV/FV), BI (PV)	1-bit / bool	Binary output, binary input
AO (PV), AI (PV)	32-bit float	Analogue output, analogue input
MO (PV/FV), MI (PV)	32-bit UInt	Multi-state output, multi-state input (values: 1...8)
PIV (PV: In/Out)	32-bit UInt	Positive Integer Value (as input or output)
PC (PV)	32-bit float	Pulse Converter (reading only as input, to Present Value)

### Supported Modbus functions

Master function with different communication parameters (one main profile and up to three additional profiles). The following Modbus functions ("function codes") are supported:

Modbus function code	Type	Description
FC01	Bit(s)	Read Coils (R/W) – read bit value(s) (L/S)
FC02	Bit(s)	Read Discrete Inputs (R) – read bit value(s) (L)
FC03	16/32/64-bit	Read Holding Registers (R/W, multiple) – read 16-bit values (L/S)
FC04	16/32/64-bit	Read Input Registers (R, multiple) – read 16-bit values (L)
FC05	Bit	Write Single Coil (R/W) – write bit value (L/S)
FC06	16-bit	Write Holding Register (R/W, single) – write 16-bit value (L/S)
FC15	Bits	Write Multiple Coils (R/W) – write bit values (L/S)
FC16	16/32/64-bit	Write Multiple Registers (R/W) – write 16-bit values (L/S)
FC22	16-bit	Mask Write Register (R/W) – write one or multiple bits to the register (L/S)

Supported Modbus data types: 1-bit, 8-bit (U8/S8), 16-bit (U16/S16), 32-bit (U32/S32/F32), 64-bit (U64/S64/F64)

Broadcast commands with FC05, 06, 15, 16 (Modbus broadcast address is 0).

Byte sequence (endianness) is configurable for up to 8 bytes.

Bit separation (bit select, bit quantity) is possible for bit fields (up to 64 bits/4 registers).

Special functions:

- Combined read/write command "Read-Modify-Write Registers" (FC03/FC16) for BO/PIV(Out)/MO
- Trigger command "Device Read Trigger" for BO/PIV(Out)/MO. All inputs of a device are read again
- Automatic access optimisation for Modbus data in series (registers):
- Only for RTU mode
- Max. 256 optimised accesses of max. 1024 registers in total

Optimised access of multiple bits in series mapped with Positive Integer Value (max. 32 bits).

Automatic master changeover if the master tool is connected via virtual port. The master tool only runs with Modbus main profile.

Virtual serial port for telegram monitoring ("listening function") for commissioning, monitoring, analysis etc. with "cm\_status" in the "IO-Unit" BACnet object can be switched on and off.

#### Note



Erroneous reading or writing is supported with the BACnet property "Reliability".

When converting values with different formats (e.g. U32/F32, U64/F32) from analogue objects, the value may lose accuracy and resolution. The BACnet side does not support 64-bit values (U64/S64/F64).







#### Note



When executing Modbus commands and querying Modbus devices, it must be ensured that the bus load does not reach the limits (e.g. approx. five telegrams per second for baud rate 9600 bit/s).

The inter-communication of the Modbus interface and the BACnet data is also limited. This process is subordinate to the control main process, the Ethernet communication process (BACnet/IP) and the SLC communication process. When ecoLink SLC devices are being used simultaneously, the data rate for the corresponding number of Modbus channels must be monitored and reduced if necessary.

**LED indicator for RS-485 (Modbus)**

RS-485 (Modbus)	Indicator sequence	Description
Continuous green		OK (no bus communication, no plan, empty plan (without Modbus data points), all data points OK)
Flashing green		OK (active bus communication, all data points OK)
Continuous orange		Start-up phase; communication is being set up
Continuous red		Not used
Flashing red		Communication error (at least one data point cannot set up correct communication with a Modbus device)
Slowly flashing red		Loading plan from controller (ecos) to COM module; frequency depends on plan download

**M-Bus and RS-232 interface for M-Bus (meter bus)**

The M-Bus interface (EN 137572) with the M-Bus master application (EN 137573) enables direct integration of up to 40 M-Bus meters (heat, electricity, water meters). The physical M-Bus layer and RS-232 interface are electrically isolated from the controller. Two microprocessors (APP, PHY) fulfil a modern M-Bus implementation according to EN 13757. With the additional RS-232 interface, further M-Bus meters can be integrated via an external RS-232 M-Bus level converter. The M-Bus master application on the communication module transfers the meter values suitably to the BACnet/IP automation and can be used with CASE Suite (from V4.1) and ecos504/505 (from V3.5).

The M-Bus meters are engineered in CASE Engine. The M-Bus data points are mapped to the CASE Engine input and value objects (AI, BI, PIV(I)). An output object can be used to trigger the M-Bus readout of a meter. This allows the meter values, like all other objects, to be used in freely programming control and logic functions with CASE Engine (e.g. load shedding in the event of excessive energy consumption, energy monitoring with Trend Log). Here the ecos communicates with all meters. The M-Bus network is therefore a local field bus within room or building automation with BACnet.

The M-Bus network (M+/M-) can be wired in a line, tree or star connection with installation cables such as J-Y(ST)Y 4 × 0.5 mm<sup>2</sup> (recommended with double wire guide) or, in more extensive networks, with stronger cables such as LiYY 2 × 1.5 mm<sup>2</sup>. Depending on cable cross-section, baud rate, number of M-Bus unit loads and topology (number of segments), standard M-Bus networks are possible up to 1000 or 4000 metres. The table shows typical M-Bus network configurations:

Configuration	Cable	Max. segment length (m)	Quantity	Max. M-Bus (UL)	Max. baud rate
Mini	J-Y(ST)Y 4 × 0.5 mm <sup>2</sup>	350	1	40	38,400
Building, small	J-Y(ST)Y 4 × 0.5 mm <sup>2</sup>	350	3	40	38,400
Building, large	J-Y(ST)Y 4 × 0.5 mm <sup>2</sup>	350	10	40	19,200
Several buildings	J-Y(ST)Y 4 × 0.5 mm <sup>2</sup>	1000	4	40	19,200
Wide area	LiYY J-Y(ST) 2 × 1.5 mm <sup>2</sup>	4000	1	40	9600

The M-Bus module as master supports up to 4 different communication parameters (fixed baud rates) simultaneously. The M-Bus module supports M-Bus devices with primary or secondary addressing. Before commissioning, the M-Bus devices and their supported functions must be clarified and configured. With CASE Engine, the functions (module configuration, device table, BACnet I/O/V modules) are parameterised for the devices and loaded onto the controller. For easy commissioning and maintenance, a virtual serial port can be activated on the controller, so that M-Bus master tools (addressing/configuration) or the ecosReader tool (bus analysis) can connect directly to the M-Bus network via IP/Ethernet without an additional M-Bus level converter.

All M-Bus devices as per EN 13757-2/-3 can be used with the ecos M-Bus. However, the following must be considered:

- Supported M-Bus functions
- Supported M-Bus data types and units
- Number of data points, max. 400

- Number of devices, max. 256 (logical) or 40 M-Bus unit loads of 1.5 mA (physical)
- Device communication parameters: Baud rate, COM errors, timings, connection to M-Bus/IF or RS-232 etc.

### BACnet mapping

Standard BACnet input/output objects and Positive Integer Value objects can be used with M-Bus.

BACnet objects	Type	Description
AI (PV)	32-bit float	Analogue input
PIV (PV:In)	32-bit UInt	Positive Integer Value (as input)
PC (PV)	32-bit float	Pulse Converter (reading only as input, to PV)
BO (PV)	1-bit / bool	Binary output
PIV (PV:Out), MO (PV)	32-bit UInt	Multi-state output, Positive Integer Value (as output)
AO (PV)	32-bit float	Analogue output

The BACnet output objects are used to control (“trigger”) the reading of an M-Bus meter (DEVICE-READ-TRIGGER: 0=off, 1=trigger normal); e.g. for battery-operated M-Bus meters

### Supported M-Bus functions

The COM module supports the master function with different communication parameters (one main profile and up to three additional profiles). The following M-Bus functions are supported:

M-Bus function	Type	Description
REQ_UD2	–	Normal readout of the M-Bus device
SND_NKE	–	Normalisation telegram: Sets telegram counter to 0, for meters with multi-telegram readouts
SND_UD	–	Telegram (internal) for configuring and addressing the readout: - Global read-out: Global read-out request = command that all data is read out with REQ_UD2 - Secondary Address Selection: Using ID, MANUF, VERSION, MEDIA and with wild-cards
READ by offset	–	Data selection of the RES_UD response according to record and page number
READ by filter	–	Data selection of the RES_UD response according to the filter setting for DIB/VIB
DEVICE-READ-TRIGGER	–	Triggered readout of an M-Bus device: QUERY-INTERVAL = 0: Readout only if DEVICE-READ-TRIGGER QUERY-INTERVAL > 0: -- Normal: In normal mode the readout is triggered in addition to the regular readout cycle
RES_UD	–	Response telegram of a readout telegram
CI fields	CI field	
	0x72	Mode: 0=LSB, Header: long, DataFrame: complete
	0x78	Mode: 0=LSB, Header: none, DataFrame: complete
	0x7A	Mode: 0=LSB, Header: short, DataFrame: complete
	0x73/77	Mode: 0/1, Header: n/a, DataFrame: n/a (for “Legacy” M-Bus meters with fixed data structure)
Data types	Data type	
-- Fixed length	INTx	x-bit integer (INT8, 16, 24, 32, 48, 64)
	F32	32-bit floating point number
	BCDx	x-character BCD-coded number (BCD2, 4, 6, 8, 12)
-- Variable length	Pos. BCDx	Positive x-character BCD-coded number (without prefixed sign: BCD0...16)
	Neg. BCDx	x-character BCD-coded number (with prefixed sign: BCD0...16)
	INTx	x-bit integer (INT0, 1, ...64)
Value types	VIF code	Primary VIF codes, 1st VIF and 2nd VIF extension codes Orthogonal VIF codes (partly supported)
Units	Units	Primary VIF codes: All units, except time, date and texts 1st VIF codes: All units 2nd VIF codes: No units, except voltage (V) and current (A) Fixed units: All units, also “NoUnit”, except HCA
M-Bus error	Error code	M-Bus error codes (device, application, data record) are not supported

### Notes on supported M-Bus functions

CI field:

CI fields for M-Bus wireless. COSEM protocol and OBIS protocol are not supported.

CI field 0x73/77:

The module interprets CI = 0x73/77 as a meter with a fixed data structure (for "legacy" meters as per EN1434-3:1997)

Data type:

Data type value of the M-Bus device is assigned to the data type of the assigned BACnet object (Float32, UInt32). Other M-Bus data types (e.g. text) are not supported because no suitable mapping to BACnet objects exists. The M-Bus module calculates internally with 64-bit data values so that the mapping to the BACnet object can be done with the highest possible accuracy.

VIF Code:

Since the RES\_UD response can respond with a fixed or variable data structure, the M-Bus module automatically selects the correct conversion to the data types and units configured in the plan. The M-Bus module also combines orthogonal VIF codes with the VIF/E codes if it makes sense (e.g. multiplicative or additive value corrections, modifiers for non-metric units)

Units:

The M-Bus module automatically converts the data value into the unit configured and specified in the module so that the same unit can be selected in the BACnet object. With a few exceptions, all units according to VIF/E including non-metric units according to standard Appendix C are supported. Automatic M-Bus meter value switching (value/unit modifier) with value jumps can thus be avoided. If mapping is not possible (e.g. no suitable alternative unit, unsupported modifiers), Reliability Flag = 0 is set in the object so that Status Flag Error (COM error) appears in the object. If the value type / unit of a record is not supported, the raw data value can still be read.

Error code:

M-Bus error handling for devices, application and data values is not supported. Only devices that do not respond or value / unit pairs that cannot be mapped correctly are reported by the module as a COM error (Reliability FALSE).

### Notes on M-Bus engineering and commissioning



#### Caution!

Possible device damage due to simultaneous operation of several M-Bus masters

- ▶ The ecos-M-Bus as M-Bus master must never be wired and operated simultaneously with another M-Bus master (e.g. M-Bus/USB level converter and M-Bus master tool).
- 







The ecos-M-Bus makes an automatic master switchover if the master tool is connected via virtual port. The master tool runs with the communication parameters which are set in the "cm\_master\_..." properties of the BACnet object "IO-Unit" (baud rate, M-Bus or RS-232 interface).

The ecos-M-Bus with the tunnel (virtual port) handles M-Bus master tool access automatically. Depending on the tool (e.g. RELAY MB Sheet, PiiGAB M-Bus Wizard) and its options for setting communication parameters (baud rate, timeouts) and M-Bus scan procedure parameters, M-Bus networks can be read out via ecos and under certain circumstances also addressed and configured. Because M-Bus master tools have certain requirements (timings), they should only be used during commissioning and with as empty a plan as possible, or with meters deactivated in the device table.

The virtual serial port for telegram monitoring ("listening function") for commissioning, monitoring, analysis etc. can be activated or deactivated with "cm\_status" in the "IO-Unit" BACnet object. The ecosReader ("Modbus/M-Bus listening tool") integrates this functionality and is therefore ideal for support purposes.



## M-Bus LED indicator

M-Bus	Indicator sequence	Description
Continuous green		OK (no bus communication, no plan, empty plan (without M-Bus data points))
Flashing green		OK (active bus communication, all M-Bus data points OK)
Continuous orange		Start-up phase of the COM module, establishing communication
Continuous red		M-Bus error (bus not yet ready for communication, at start-up; bus short circuit; overcurrent detection with shutdown), has higher priority than communication error
Flashing red		Communication error (communication with at least one M-Bus device is faulty)
Slowly flashing red		Loading plan from controller (ecos) to COM module; frequency depends on plan download

- While switching on the controller with M-Bus module (start-up) the M-Bus LED has the following LED sequence: "Continuous orange (~5 seconds) – slowly flashing red (~5 seconds) – continuous red (up to ~30 seconds, M-Bus current measurement calibration) – flashing/continuous green".
- An LED sequence "500 milliseconds red – 500 milliseconds green – 500 milliseconds off" indicates a faulty application.  
A factory reset of the ecos controller and a firmware update of the M-Bus module are recommended.

## Additional information

Technical information	
Fitting instructions	P100014308
BACnet PICS ecos504/ecos505	D100275255
BACnet BTL Certification	No: BTL-30257 (V3.1.0b753) for EY-RC504F*** and EY-RC505F***
AMEV attestation	In preparation
Declaration on materials and the environment	MD 94.112
ecos 5 engineering guidelines	See SAUTER extranet
Compatibility list for ecos-EnOcean	D100119337
Compatibility list for ecos-DALI	D100317613
Compatibility list for ecos-SMI	D100370158
Compatibility list/information for ecos-Modbus	D100392305
Operating manual for moduWeb	7010050001 (DE), 7010050002 (FR), 7010050003 (EN)

## Applications as per eu.bac (eu.bac Cert)

The ecos504/505 combined with ecoLink can be equipped with certified applications as single-room controllers as per EN 15500 and the eu.bac "General Rules" and "Specific Rules". The certificates are available at <http://www.eubacert.eu/> → "List of eu.bac approved products". Further information on the applications for the fan coil unit (2-/4-pipe, 2-pipe with reheater) and chilled/heated ceilings with very good control results (CA values between 0.0 K and 0.3 K) is available from SAUTER.

## Disposal

When disposing of the product, observe the currently applicable local laws.

More information on materials can be found in the Declaration on materials and the environment for this product.

Connection diagram for EY-RC504F\*\*\*, EY-RC505F\*\*\*

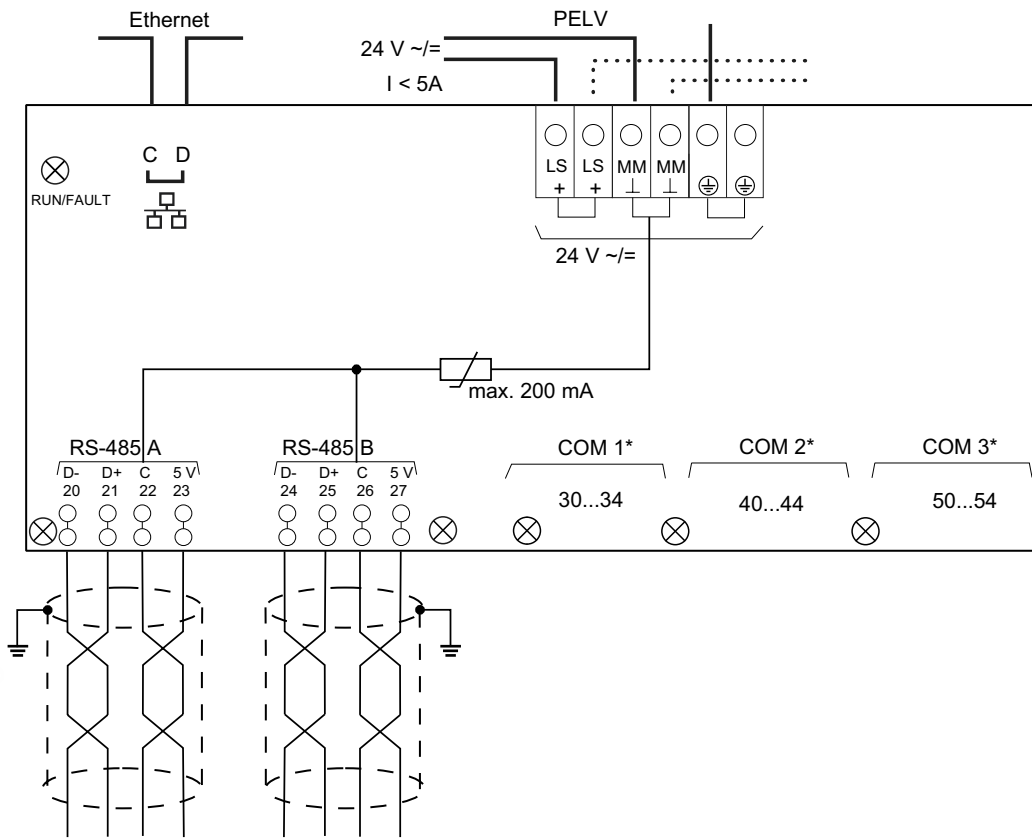

\* See overview of types. Connection diagrams for the COM ports can be found in the fitting instructions

### Bus wiring

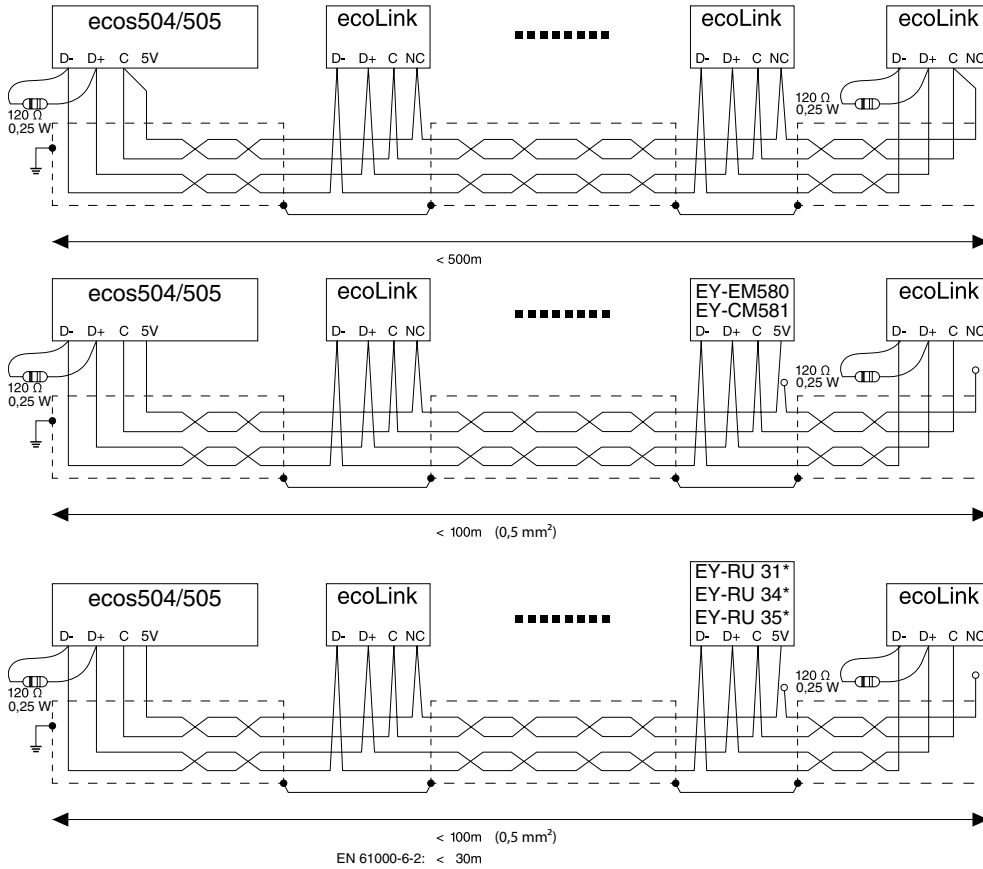

When EY-RU 31\* and EY-RU 34\* are used, the max. total bus length permitted is 30 m in order to fulfil EN 61000-6-2. If EN 61000-6-2 is not required, the max. bus length may be up to 100 m. (Cross-section of cable  $\geq 0.5 \text{ mm}^2$ )

Further bus cabling options are to be found in the fitting instructions.

### Dimension drawings

All dimensions in millimetres.

#### EY-RC 504

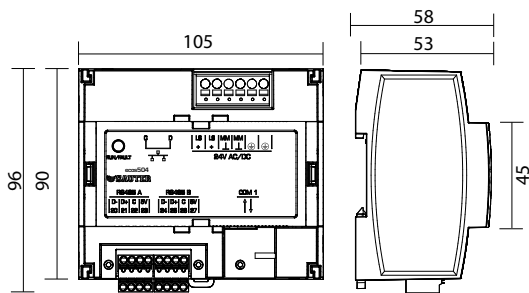

#### EY-RC 505

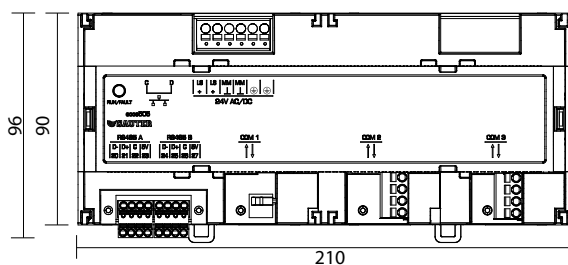

Fr. Sauter AG  
 Im Surinam 55  
 CH-4058 Basel  
 Tel. +41 61 - 695 55 55  
 www.sauter-controls.com