



# Kern- und Teilchenphysik II

## Lecture 3: CP Violation

(adapted from the Handout of Prof. Mark Thomson)

Prof. Nico Serra

Dr. Marcin Chrzaszcz

Dr. Annapaola De Cosa (guest lecturer)

<http://www.physik.uzh.ch/de/lehre/PHY213/FS2017.html>

# CP Violation in the Early Universe

- Very early in the universe might expect equal numbers of baryons and anti-baryons
- However, today the universe is matter dominated (no evidence for anti-galaxies, etc.)
- From “Big Bang Nucleosynthesis” obtain the matter/anti-matter asymmetry

$$\xi = \frac{n_B - n_{\bar{B}}}{n_\gamma} \approx \frac{n_B}{n_\gamma} \approx 10^{-9}$$

i.e. for every baryon in the universe today there are  $10^9$  photons

## • How did this happen?

- ★ Early in the universe need to create a very small asymmetry between baryons and anti-baryons

e.g. for every  $10^9$  anti-baryons there were  $10^9+1$  baryons

baryons/anti-baryons annihilate 

1 baryon +  $\sim 10^9$  photons + no anti-baryons

- ★ To generate this initial asymmetry three conditions must be met (Sakharov, 1967):

- ① “Baryon number violation”, i.e.  $n_B - n_{\bar{B}}$  is not constant
- ② “C and CP violation”, if CP is conserved for a reaction which generates a net number of baryons over anti-baryons there would be a CP conjugate reaction generating a net number of anti-baryons
- ③ “Departure from thermal equilibrium”, in thermal equilibrium any baryon number violating process will be balanced by the inverse reaction

# The Weak Interaction of Quarks

- ★ Slightly different values of  $G_F$  measured in  $\mu$  decay and nuclear  $\beta$  decay:

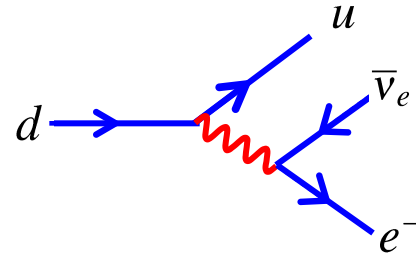
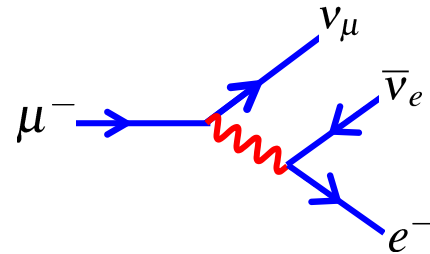

$$G_F^\mu = (1.16632 \pm 0.00002) \times 10^{-5} \text{ GeV}^{-2}$$

$$G_F^\beta = (1.136 \pm 0.003) \times 10^{-5} \text{ GeV}^{-2}$$

- ★ In addition, certain hadronic decay modes are observed to be suppressed, e.g. compare  $K^- \rightarrow \mu^- \bar{\nu}_\mu$  and  $\pi^- \rightarrow \mu^- \bar{\nu}_\mu$ . Kaon decay rate suppressed factor 20 compared to the expectation assuming a universal weak interaction for quarks.

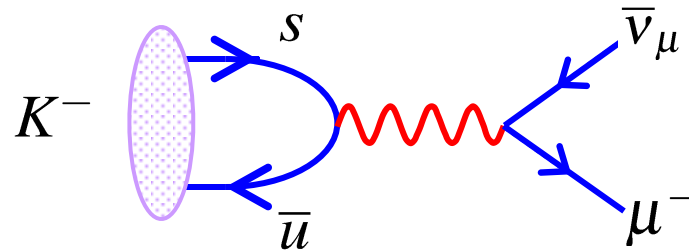
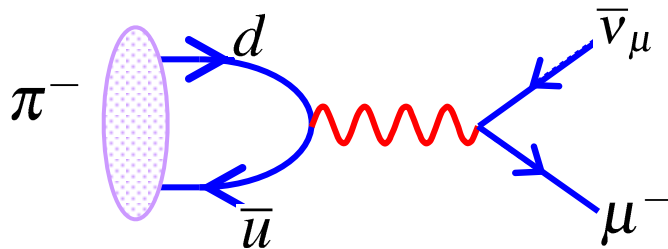

- Both observations explained by Cabibbo hypothesis (1963): weak eigenstates are different from mass eigenstates, i.e. weak interactions of quarks have same strength as for leptons but a u-quark couples to a linear combination of s and d

$$\begin{pmatrix} d' \\ s' \end{pmatrix} = \begin{pmatrix} \cos \theta_c & \sin \theta_c \\ -\sin \theta_c & \cos \theta_c \end{pmatrix} \begin{pmatrix} d \\ s \end{pmatrix}$$

# GIM Mechanism

- ★ In the weak interaction have couplings between both  $ud$  and  $us$  which implies that neutral mesons can decay via box diagrams, e.g.

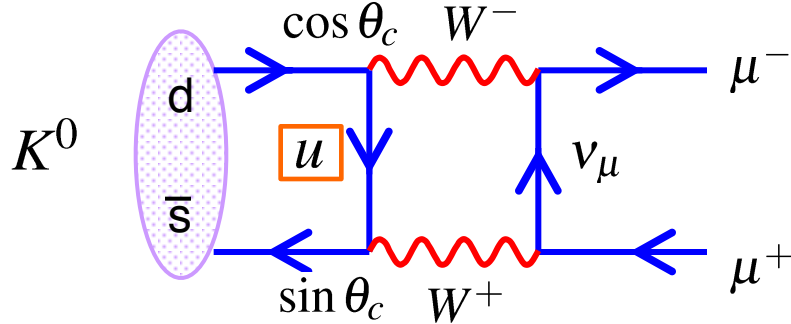

$$M_1 \propto g_W^4 \cos \theta_c \sin \theta_c$$

- Historically, the observed branching was much smaller than predicted

- ★ Led Glashow, Iliopoulos and Maiani to postulate existence of an extra quark - before discovery of charm quark in 1974. Weak interaction couplings become

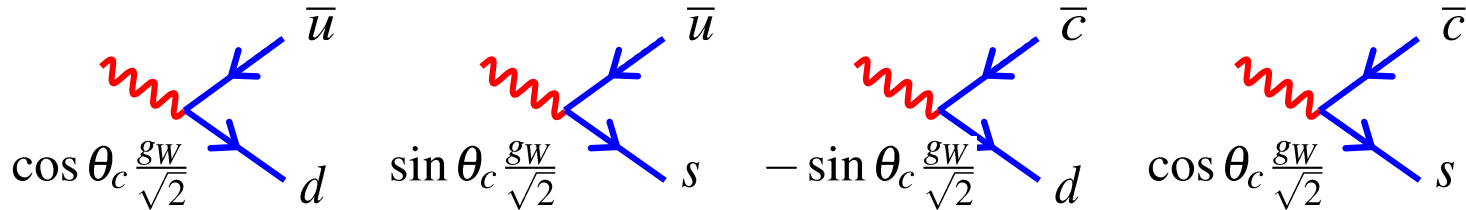

- ★ Gives another box diagram for  $K^0 \rightarrow \mu^+ \mu^-$

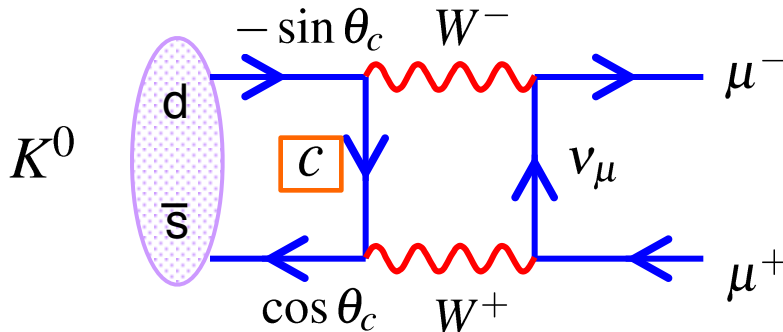

$$M_2 \propto -g_W^4 \cos \theta_c \sin \theta_c$$

- Same final state so sum amplitudes

$$|M|^2 = |M_1 + M_2|^2 \approx 0$$

- Cancellation not exact because  $m_u \neq m_c$

i.e. weak interaction couples different generations of quarks

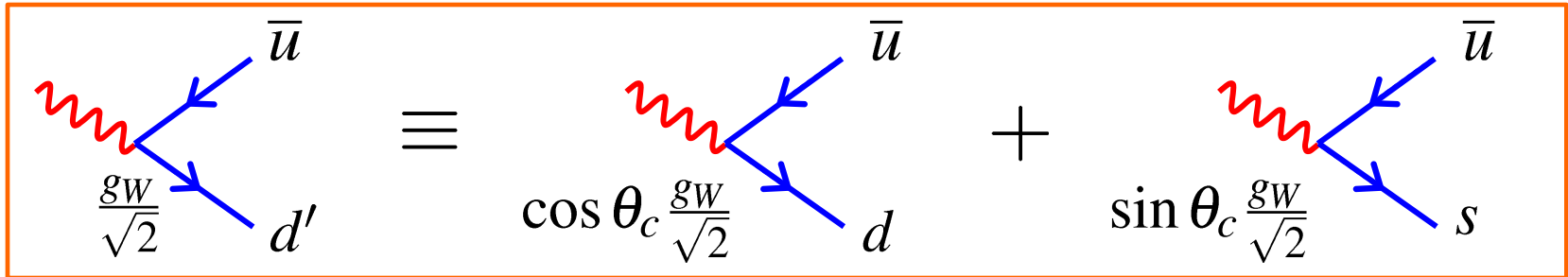

(The same is true for leptons e.g.  $e^- \nu_1$ ,  $e^- \nu_2$ ,  $e^- \nu_3$  couplings – connect different generations)

- ★ Can explain the observations on the previous pages with  $\theta_c = 13.1^\circ$
- Kaon decay suppressed by a factor of  $\tan^2 \theta_c \approx 0.05$  relative to pion decay

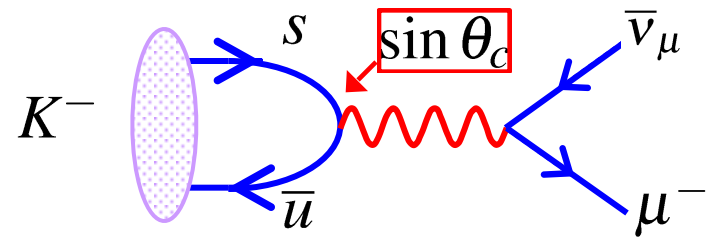
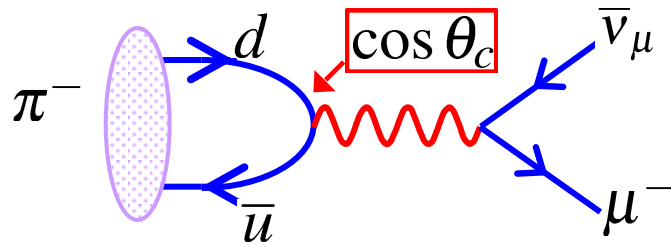

$$\Gamma(\pi^- \rightarrow \mu^- \bar{\nu}_\mu) \propto |M|^2 \propto \cos^2 \theta_c$$

$$\Gamma(K^- \rightarrow \mu^- \bar{\nu}_\mu) \propto |M|^2 \propto \sin^2 \theta_c$$

- Hence expect  $G_F^\beta = G_F^\mu \cos \theta_c$

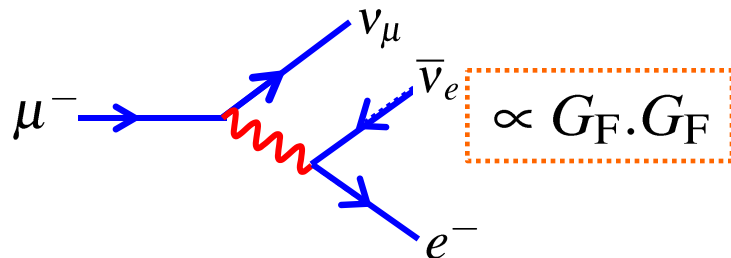

$$\propto G_F \cdot G_F$$

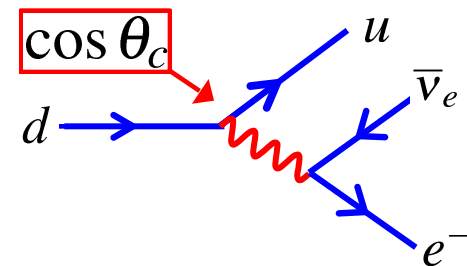

$$\propto G_F \cdot (G_F \cos^2 \theta_c)$$

# CKM Matrix

- ★ Extend ideas to three quark flavours (analogue of three flavour neutrino treatment)

$$\begin{pmatrix} d' \\ s' \\ b' \end{pmatrix} = \begin{pmatrix} V_{ud} & V_{us} & V_{ub} \\ V_{cd} & V_{cs} & V_{cb} \\ V_{td} & V_{ts} & V_{tb} \end{pmatrix} \begin{pmatrix} d \\ s \\ b \end{pmatrix}$$

By convention CKM matrix defined as acting on quarks with charge  $-\frac{1}{3}e$

Weak eigenstates

CKM Matrix

Mass Eigenstates

( Cabibbo, Kobayashi, Maskawa )

- ★ e.g. Weak eigenstate  $d'$  is produced in weak decay of an up quark:

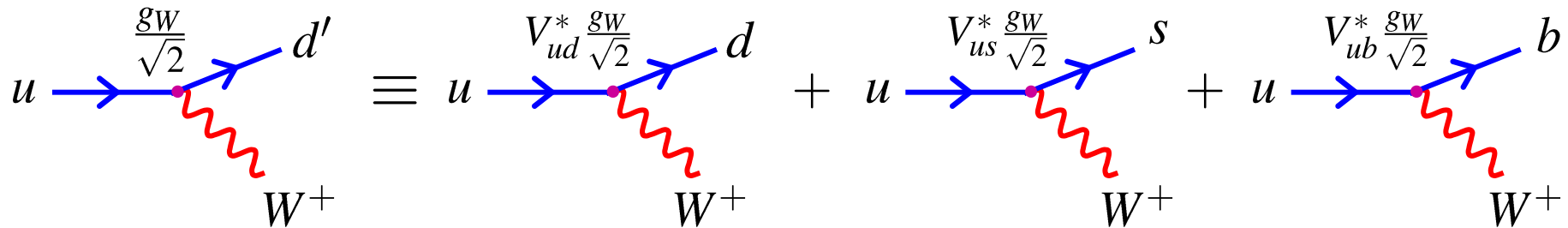

- The CKM matrix elements  $V_{ij}$  are complex constants
- The CKM matrix is unitary
- The  $V_{ij}$  are not predicted by the SM – have to determined from experiment

# Feynman Rules

- Depending on the order of the interaction,  $u \rightarrow d$  or  $d \rightarrow u$ , the CKM matrix enters as either  $V_{ud}$  or  $V_{ud}^*$
- Writing the interaction in terms of the WEAK eigenstates

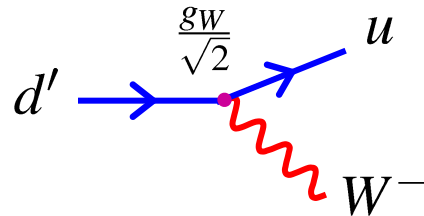

$$j_{d'u} = \bar{u} \left[ -i \frac{g_W}{\sqrt{2}} \gamma^\mu \frac{1}{2} (1 - \gamma^5) \right] d'$$

NOTE:  $\bar{u}$  is the adjoint spinor not the anti-up quark

$$j_{du} = \bar{u} \left[ -i \frac{g_W}{\sqrt{2}} \gamma^\mu \frac{1}{2} (1 - \gamma^5) \right] V_{ud} d$$

- Giving the  $d \rightarrow u$  weak current:

- For  $u \rightarrow d'$  the weak current is:

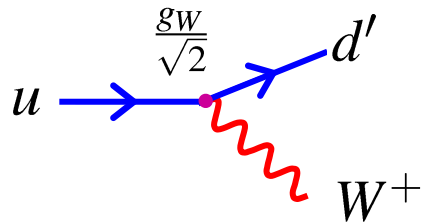

$$j_{ud'} = \bar{d}' \left[ -i \frac{g_W}{\sqrt{2}} \gamma^\mu \frac{1}{2} (1 - \gamma^5) \right] u$$

- In terms of the mass eigenstates

$$\bar{d}' = d'^{\dagger} \gamma^0 \rightarrow (V_{ud} d)^{\dagger} \gamma^0 = V_{ud}^* d^{\dagger} \gamma^0 = V_{ud}^* \bar{d}$$

- Giving the  $u \rightarrow d$  weak current:

$$j_{ud} = \bar{d} V_{ud}^* \left[ -i \frac{g_W}{\sqrt{2}} \gamma^\mu \frac{1}{2} (1 - \gamma^5) \right] u$$

- Hence, when the charge  $-\frac{1}{3}$  quark enters as the adjoint spinor, the complex conjugate of the CKM matrix is used

★ The vertex factor the following diagrams:

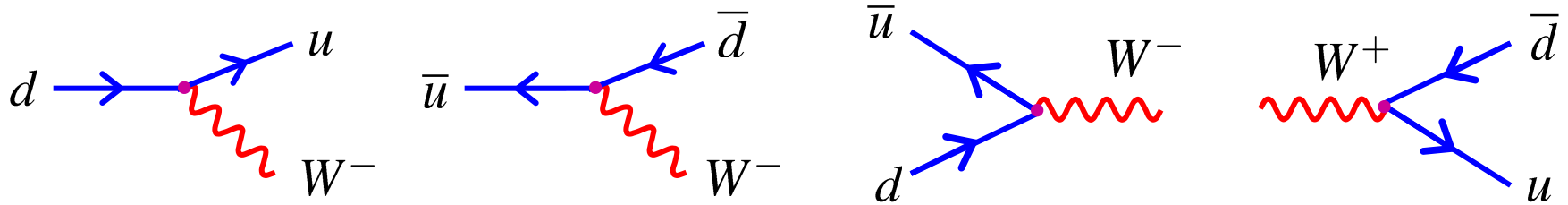

is

$$-i \frac{g_W}{\sqrt{2}} V_{ud} \gamma^\mu \frac{1}{2} (1 - \gamma^5)$$

★ Whereas, the vertex factor for:

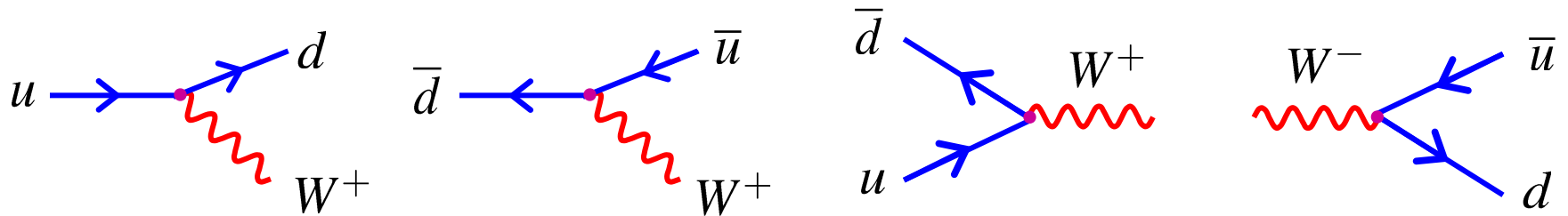

is

$$-i \frac{g_W}{\sqrt{2}} V_{ud}^* \gamma^\mu \frac{1}{2} (1 - \gamma^5)$$



$$\begin{pmatrix} |V_{ud}| & |V_{us}| & |V_{ub}| \\ |V_{cd}| & |V_{cs}| & |V_{cb}| \\ |V_{td}| & |V_{ts}| & |V_{tb}| \end{pmatrix} \approx \begin{pmatrix} 0.974 & 0.226 & 0.004 \\ 0.23 & 0.96 & 0.04 \\ 0.01 & 0.04 & 0.999 \end{pmatrix}$$

Cabibbo matrix

- ★ NOTE: within the SM, the charged current,  $W^\pm$ , weak interaction:
- ① Provides the only way to **change flavour** !
  - ② only way to **change from one generation** of quarks or leptons to another !

- ★ However, the off-diagonal elements of the CKM matrix are relatively small.
- Weak interaction largest between quarks of the same generation.
  - Coupling between first and third generation quarks is very small !

★ The number of free parameters in the CKM matrix are three real parameters and one imaginary phase

★ The presence of an imaginary phase is source of CP violation!

# The Neutral Kaon System

- **Neutral Kaons** decay via the weak interaction
- The Weak Interaction also allows **mixing** of neutral kaons via “**box diagrams**”

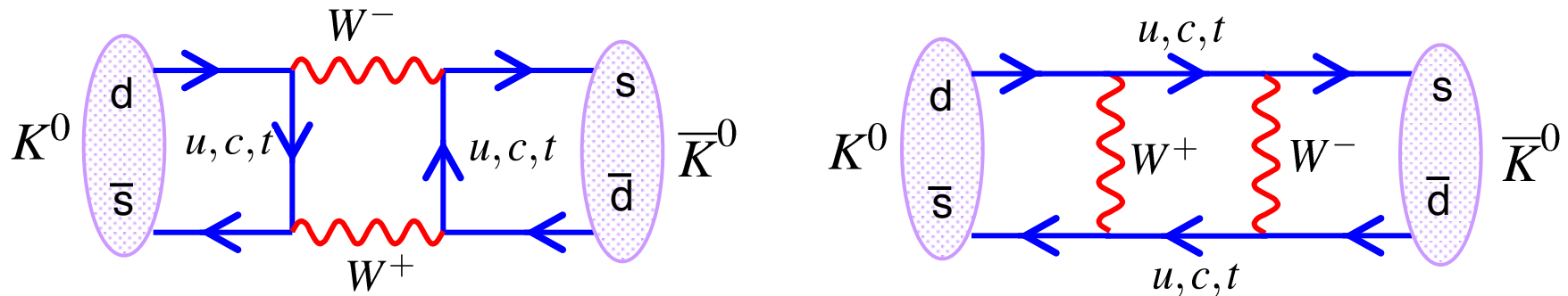

- The fact that for the quarks eigenstates of flavour are NOT eigenstates of mass implies that the \$u\$ couples not only with the \$d\$, but with the \$s\$ as well (this would not happen otherwise)
- This allows **transitions** between the strong eigenstates states  $K^0, \bar{K}^0$
- Consequently, the neutral kaons propagate as eigenstates of the overall strong + weak interaction; i.e. as linear combinations of  $K^0, \bar{K}^0$
- These neutral kaon states are called the “**K-short**”  $K_S$  and the “**K-long**”  $K_L$
- These states have approximately the same mass  $m(K_S) \approx m(K_L) \approx 498 \text{ MeV}$
- But very different lifetimes:  $\tau(K_S) = 0.9 \times 10^{-10} \text{ s}$   $\tau(K_L) = 0.5 \times 10^{-7} \text{ s}$

# CP Violation and the CKM Matrix

★ How can we explain  $\Gamma(\bar{K}_{t=0}^0 \rightarrow K^0) \neq \Gamma(K_{t=0}^0 \rightarrow \bar{K}^0)$  in terms of the CKM matrix ?

★ Consider the box diagrams responsible for mixing, i.e.

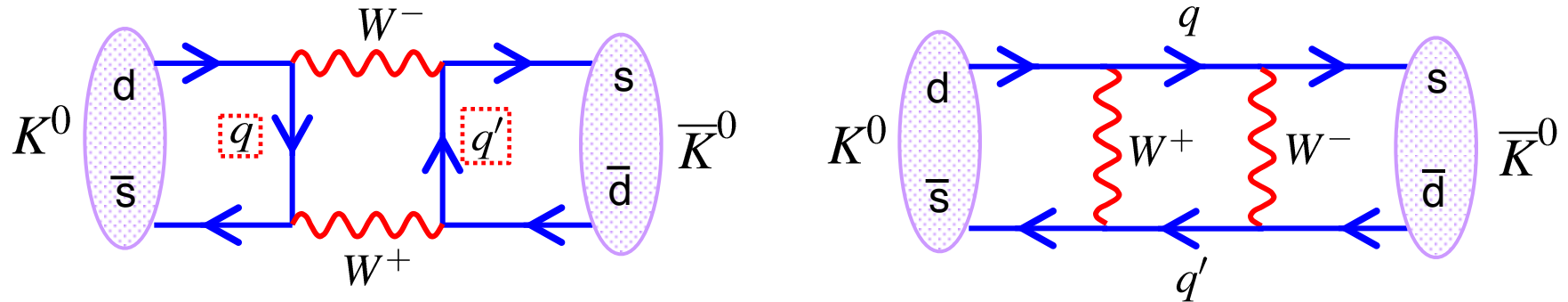

where  $q = \{u, c, t\}$ ,  $q' = \{u, c, t\}$

★ Have to sum over all possible quark exchanges in the box. For simplicity consider just one diagram

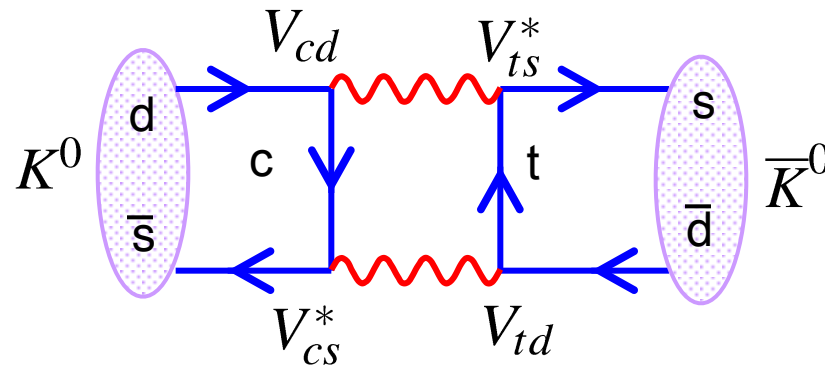

$$M_{fi} \propto A_{ct} V_{cd} V_{cs}^* V_{td} V_{ts}^*$$

A constant related to integrating over virtual momenta

★ Compare the equivalent box diagrams for  $K^0 \rightarrow \bar{K}^0$  and  $\bar{K}^0 \rightarrow K^0$

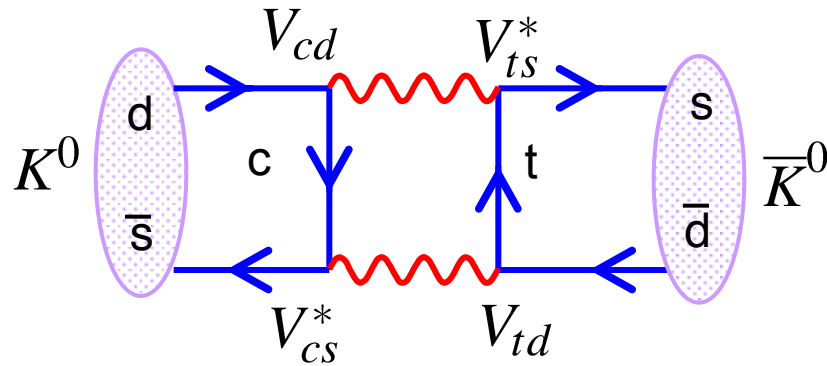

$$M_{fi} \propto A_{ct} V_{cd} V_{cs}^* V_{td} V_{ts}^*$$

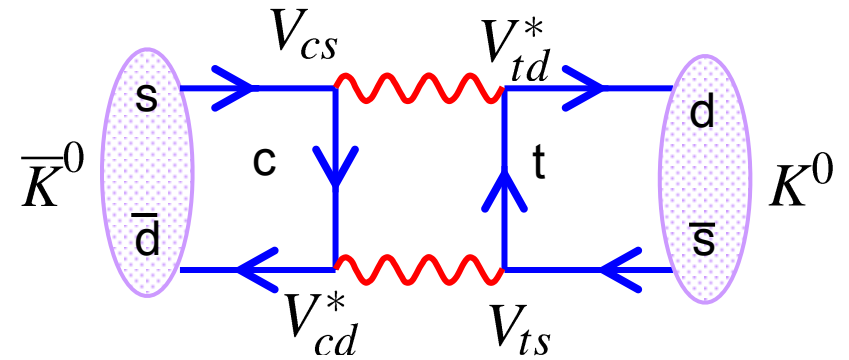

$$M'_{fi} \propto A_{ct} V_{cd}^* V_{cs} V_{td}^* V_{ts} = M_{fi}^*$$

★ Therefore difference in rates

$$\Gamma(K^0 \rightarrow \bar{K}^0) - \Gamma(\bar{K}^0 \rightarrow K^0) \propto M_{fi} - M_{fi}^* = 2\Im\{M_{fi}\}$$

★ Hence the rates can only be different if the CKM matrix has imaginary component

$$|\varepsilon| \propto \Im\{M_{fi}\}$$

★ In the kaon system we can show

$$|\varepsilon| \propto A_{ut} \cdot \Im\{V_{ud} V_{us}^* V_{td} V_{ts}^*\} + A_{ct} \cdot \Im\{V_{cd} V_{cs}^* V_{td} V_{ts}^*\} + A_{tt} \cdot \Im\{V_{td} V_{ts}^* V_{td} V_{ts}^*\}$$

Shows that CP violation is related to the imaginary parts of the CKM matrix

# Neutral Meson Oscillations

Neutral meson oscillations are caused by the eigenstates of flavour not being eigenstates of mass

$$\begin{aligned}
 |P_L\rangle &= p|P\rangle + q|\bar{P}\rangle & |P^0\rangle &= \frac{1}{2p} [|P_H\rangle + |P_L\rangle] \\
 |P_H\rangle &= p|P\rangle - q|\bar{P}\rangle & |\bar{P}^0\rangle &= \frac{1}{2q} [|P_H\rangle - |P_L\rangle]
 \end{aligned}
 \qquad |p|^2 + |q|^2 = 1$$

The Hamiltonian is given by

This terms are responsible for oscillations

$$H = M - \frac{i}{2}\Gamma = \begin{pmatrix} M_{11} & M_{12} \\ M_{12}^* & M_{11} \end{pmatrix} - \frac{i}{2} \begin{pmatrix} \Gamma_{11} & \Gamma_{12} \\ \Gamma_{12}^* & \Gamma_{11} \end{pmatrix}$$

Oscillation

Decay

Allowing the decay of the meson we also have an imaginary (dispersive part)

Hermetian matrixes M and Gamma, H is not Hermetian, why?

$$H = M = \begin{pmatrix} M_{11} & M_{12} \\ M_{12}^* & M_{11} \end{pmatrix}$$

# Neutral Meson Oscillations

Assuming CPT symmetry

$$\mathbf{H} = \begin{pmatrix} M - \frac{i}{2}\Gamma & M_{12} - \frac{i}{2}\Gamma_{12} \\ M_{12}^* - \frac{i}{2}\Gamma_{12}^* & M - \frac{i}{2}\Gamma \end{pmatrix} \quad \text{with} \quad \begin{cases} M \equiv M_{11} = M_{22} \\ \Gamma \equiv \Gamma_{11} = \Gamma_{22} \end{cases}$$

eigenvalues are

$$\omega_{H,L} = M - \frac{i}{2}\Gamma \pm \sqrt{\left(M_{12} - \frac{i}{2}\Gamma_{12}\right)\left(M_{12}^* - \frac{i}{2}\Gamma_{12}^*\right)} \equiv m_{H,L} - \frac{i}{2}\Gamma_{H,L}$$

eigenvectors imply

$$\frac{q}{p} = -\sqrt{\frac{H_{21}}{H_{12}}} = -\sqrt{\frac{M_{12}^* - \frac{i}{2}\Gamma_{12}^*}{M_{12} - \frac{i}{2}\Gamma_{12}}}$$

# Neutral Meson Oscillations

If a particle is in the initial state  $|P\rangle$  at  $t=0$

$$|P(0)\rangle = |P\rangle = \frac{1}{2p} (|P_L\rangle + |P_H\rangle)$$

It will evolve according to

$$|P(t)\rangle = \frac{1}{2p} \left( |P_L\rangle e^{-i(m_L - \frac{i}{2}\gamma_L)t} + |P_H\rangle e^{-i(m_H - \frac{i}{2}\gamma_H)t} \right) = g_+(t) |P\rangle - \frac{q}{p} g_-(t) |\bar{P}\rangle$$

where

$$g_{\pm}(t) = \frac{1}{2} \left( e^{-\frac{i}{\hbar}(m_H - \frac{i}{2}\gamma_H)t} \pm e^{-\frac{i}{\hbar}(m_L - \frac{i}{2}\gamma_L)t} \right)$$

$$|g_{\pm}(t)|^2 = \frac{1}{4} \left( e^{-\Gamma_H t} + e^{-\Gamma_L t} \pm e^{-\Gamma t} (e^{-i\Delta m t} + e^{+i\Delta m t}) \right)$$

$$= \frac{1}{4} \left( e^{-\Gamma_H t} + e^{-\Gamma_L t} \pm 2e^{-\Gamma t} \cos \Delta m t \right)$$

$$= \frac{e^{-\Gamma t}}{2} \left( \cosh \frac{1}{2} \Delta \Gamma t \pm \cos \Delta m t \right)$$

$$M = (m_H + m_L)/2 \text{ and } \Delta m = m_H - m_L$$

$$\Gamma = (\Gamma_L + \Gamma_H)/2 \text{ and } \Delta \Gamma = \Gamma_H - \Gamma_L$$

The transition probability is given by

$$|\langle \bar{P}^0 | P^0(t) \rangle|^2 = |g_-(t)|^2 \left| \frac{p}{q} \right|^2$$

# Neutral Meson Oscillations

$$x \equiv \frac{\Delta m}{\Gamma} \quad \text{related to oscillations "frequency":}$$

$$y \equiv \frac{\Delta\Gamma}{2\Gamma} \quad \text{related to oscillations "damping":}$$

These quantities can be expressed in the same unites (MeV or ps)

	$\tau = 1/\Gamma$	$\Delta m$	$x$	$y$
<i>K</i> -system	$0.26 \times 10^{-9} \text{ s}^{-1}$	$5.29 \text{ ns}^{-1}$	0.477	-1
<i>D</i> -system	$0.41 \times 10^{-12} \text{ s}$	$0.0024 \text{ ps}^{-1}$	0.0097	0.0078
<i>B</i> -system	$1.53 \times 10^{-12} \text{ s}$	$0.507 \text{ ps}^{-1}$	0.78	$0.0015^2$
<i>B<sub>s</sub></i> -system	$1.47 \times 10^{-12} \text{ s}$	$17.77 \text{ ps}^{-1}$	26.1	$0.06^2$



# Neutral Meson Oscillations

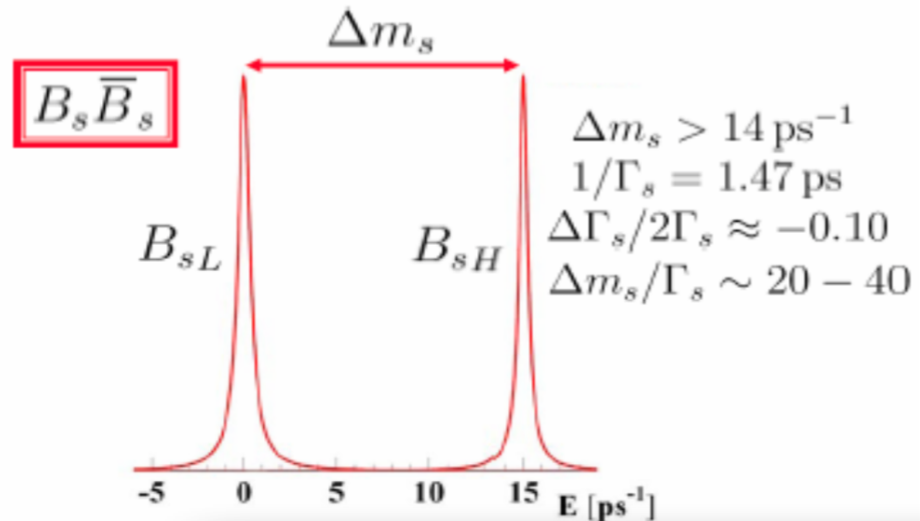
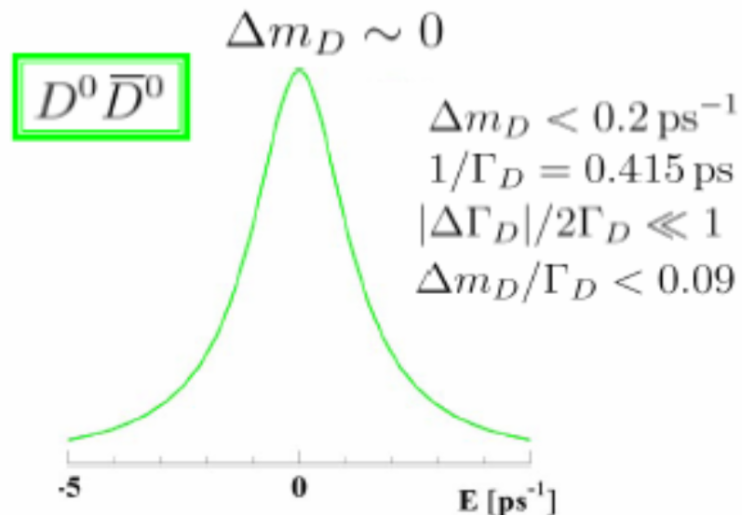
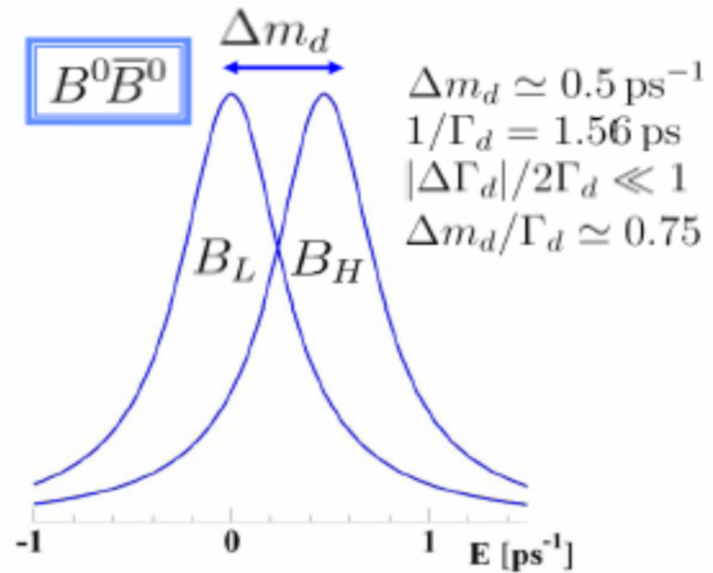
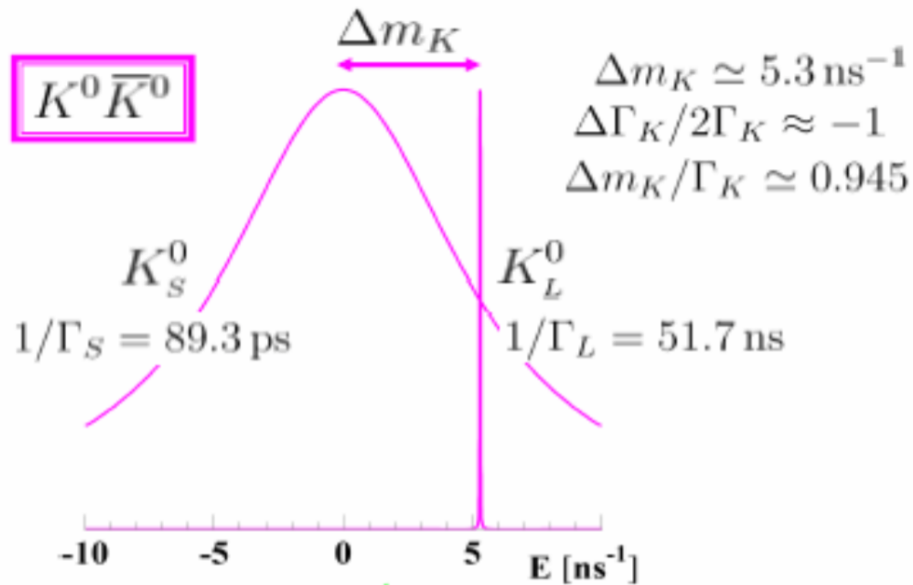

[from a seminar by G.Hamel de Monchenault]

# Neutral Meson Oscillations

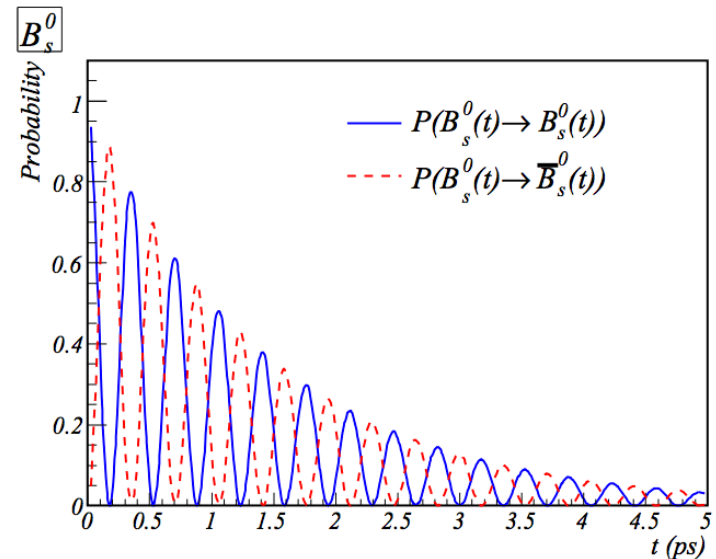
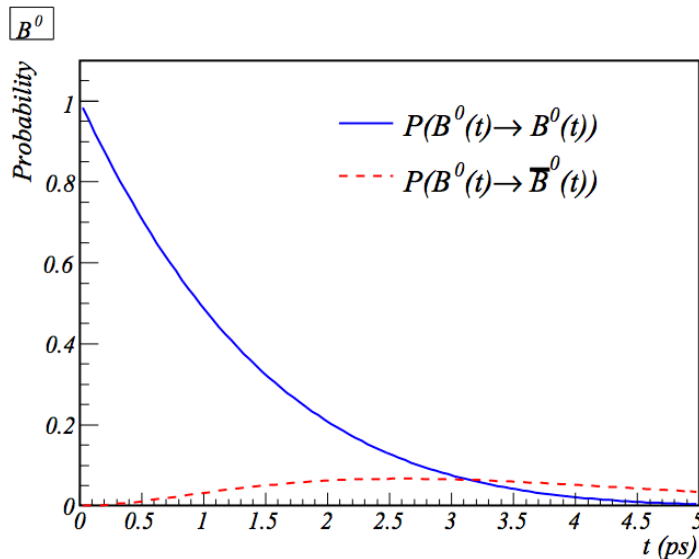
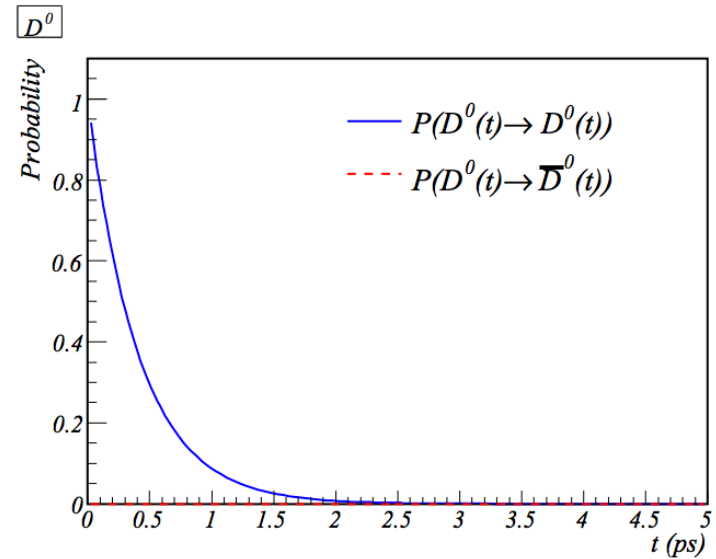
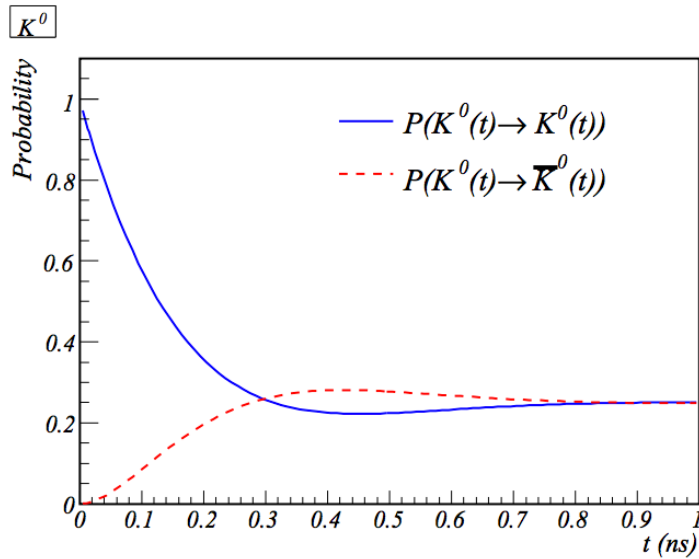

# CP Eigenstates

★ The  $K_S$  and  $K_L$  are closely related to eigenstates of the combined charge conjugation and parity operators: CP

• The strong eigenstates  $K^0(d\bar{s})$  and  $\bar{K}^0(s\bar{d})$  have  $J^P = 0^-$

with  $\hat{P}|K^0\rangle = -|K^0\rangle, \quad \hat{P}|\bar{K}^0\rangle = -|\bar{K}^0\rangle$

• The charge conjugation operator changes particle into anti-particle and *vice versa*

$$\hat{C}|K^0\rangle = \hat{C}|d\bar{s}\rangle = +|s\bar{d}\rangle = |\bar{K}^0\rangle$$

similarly  $\hat{C}|\bar{K}^0\rangle = |K^0\rangle$

The + sign is purely conventional, could have used a - with no physical consequences

• Consequently

$$\hat{C}\hat{P}|K^0\rangle = -|\bar{K}^0\rangle \quad \hat{C}\hat{P}|\bar{K}^0\rangle = -|K^0\rangle$$

i.e. neither  $K^0$  or  $\bar{K}^0$  are eigenstates of CP

• Form CP eigenstates from linear combinations:

$$|K_1\rangle = \frac{1}{\sqrt{2}} (|K^0\rangle - |\bar{K}^0\rangle)$$

$$|K_2\rangle = \frac{1}{\sqrt{2}} (|K^0\rangle + |\bar{K}^0\rangle)$$

$$\hat{C}\hat{P}|K_1\rangle = +|K_1\rangle$$

$$\hat{C}\hat{P}|K_2\rangle = -|K_2\rangle$$

# CP Eigenstates

- Neutral kaons often decay to pions (the lightest hadrons)
- The kaon masses are approximately 498 MeV and the pion masses are approximately 140 MeV. Hence neutral kaons can decay to either 2 or 3 pions
- We already showed that particle and antiparticles have opposite P, therefore ground state scalar mesons have negative parity

## Decays to Two Pions:

- The  $\pi^0 = \frac{1}{\sqrt{2}}(u\bar{u} - d\bar{d})$  is an eigenstate of  $\hat{C}$
- It is easy to show that  $\hat{C}\hat{P}(\pi^+\pi^-) = +1$  and  $CP(\pi^0\pi^0) = +1$

## Decays to Three Pions (Assuming L=0):

- Excited L are suppressed for the angular momentum barrier

$$P(\pi^0\pi^0\pi^0) = -1 \cdot -1 \cdot -1.$$

$$C(\pi^0\pi^0\pi^0) = +1 \cdot +1 \cdot +1$$

$$\Rightarrow CP(\pi^0\pi^0\pi^0) = -1$$

$$P(\pi^+\pi^-\pi^0) = -1 \cdot -1 \cdot -1.$$

$$C(\pi^+\pi^-\pi^0) = +1 \cdot C(\pi^+\pi^-)$$

$$\Rightarrow CP(\pi^+\pi^-\pi^0) = -1.$$

- So the two pion state is CP even, the three pion state is CP odd!

★ If CP were conserved in the Weak decays of neutral kaons, would expect decays to pions to occur from states of definite CP (i.e. the CP eigenstates  $K_1, K_2$  )

$ K_1\rangle = \frac{1}{\sqrt{2}} ( K^0\rangle -  \bar{K}^0\rangle)$	$\hat{C}\hat{P} K_1\rangle = + K_1\rangle$	$K_1 \rightarrow \pi\pi$	CP EVEN
$ K_2\rangle = \frac{1}{\sqrt{2}} ( K^0\rangle +  \bar{K}^0\rangle)$	$\hat{C}\hat{P} K_2\rangle = - K_2\rangle$	$K_2 \rightarrow \pi\pi\pi$	CP ODD

★ Expect lifetimes of CP eigenstates to be very different

- For two pion decay energy available:  $m_K - 2m_\pi \approx 220 \text{ MeV}$
- For three pion decay energy available:  $m_K - 3m_\pi \approx 80 \text{ MeV}$

★ Expect decays to two pions to be more rapid than decays to three pions due to increased phase space

★ This is exactly what is observed: a short-lived state “K-short” which decays to (mainly) to two pions and a long-lived state “K-long” which decays to three pions

★ In the absence of CP violation we can identify

$ K_S\rangle =  K_1\rangle \equiv \frac{1}{\sqrt{2}} ( K^0\rangle -  \bar{K}^0\rangle)$	with decays:	$K_S \rightarrow \pi\pi$
$ K_L\rangle =  K_2\rangle \equiv \frac{1}{\sqrt{2}} ( K^0\rangle +  \bar{K}^0\rangle)$	with decays:	$K_L \rightarrow \pi\pi\pi$

# CP Violation in the Kaon System

- ★ So far we have ignored CP violation in the neutral kaon system
- ★ Identified the K-short as the CP-even state and the K-long as the CP-odd state

$$|K_S\rangle = |K_1\rangle \equiv \frac{1}{\sqrt{2}} (|K^0\rangle - |\bar{K}^0\rangle) \quad \text{with decays:} \quad K_S \rightarrow \pi\pi \quad \boxed{CP = +1}$$

$$|K_L\rangle = |K_2\rangle \equiv \frac{1}{\sqrt{2}} (|K^0\rangle + |\bar{K}^0\rangle) \quad \text{with decays:} \quad K_L \rightarrow \pi\pi\pi \quad \boxed{CP = -1}$$

- ★ At a long distance from the production point a beam of neutral kaons will be 100% K-long (the K-short component will have decayed away). Hence, if CP is conserved, would expect to see only three-pion decays.
- ★ In 1964 Fitch & Cronin (joint Nobel prize) observed 45  $K_L \rightarrow \pi^+\pi^-$  decays in a sample of 22700 kaon decays a long distance from the production point



Weak interactions violate CP

- CP is violated in hadronic weak interactions, but only at the level of 2 parts in 1000

$K_L$  to pion BRs:

$K_L$	$\rightarrow \pi^+\pi^-\pi^0$	$BR = 12.6\%$	$CP = -1$
	$\rightarrow \pi^0\pi^0\pi^0$	$BR = 19.6\%$	$CP = -1$
	$\rightarrow \pi^+\pi^-$	$BR = 0.20\%$	$CP = +1$
	$\rightarrow \pi^0\pi^0$	$BR = 0.08\%$	$CP = +1$

★ Two possible explanations of CP violation in the kaon system:

i) The  $K_S$  and  $K_L$  do not correspond exactly to the CP eigenstates  $K_1$  and  $K_2$

$$|K_S\rangle = \frac{1}{\sqrt{1+|\varepsilon|^2}} [ |K_1\rangle + \varepsilon |K_2\rangle ] \quad |K_L\rangle = \frac{1}{\sqrt{1+|\varepsilon|^2}} [ |K_2\rangle + \varepsilon |K_1\rangle ]$$

with  $|\varepsilon| \sim 2 \times 10^{-3}$

• In this case the observation of  $K_L \rightarrow \pi\pi$ s accounted for by:

$$|K_L\rangle = \frac{1}{\sqrt{1+|\varepsilon|^2}} [ |K_2\rangle + \varepsilon |K_1\rangle ]$$

$\swarrow$   $\pi\pi$  CP = +1  
 $\searrow$   $\pi\pi\pi$  CP = -1

ii) **and/or** CP is violated in the decay

$$|K_L\rangle = |K_2\rangle$$

CP = -1  
 $\swarrow$   $\pi\pi\pi$  CP = -1  
 $\searrow$   $\pi\pi$  CP = +1

Parameterised by  $\varepsilon'$

★ Experimentally both known to contribute to the mechanism for CP violation in the kaon system but **i)** dominates:  $\varepsilon'/\varepsilon = (1.7 \pm 0.3) \times 10^{-3}$  } NA48 (CERN)  
KTeV (FermiLab)

# Neutral Kaon Decays to pions

- Consider the decays of a beam of  $K^0$
- The decays to pions occur in states of definite CP
- If CP is conserved in the decay, need to express  $K^0$  in terms of  $K_S$  and  $K_L$

$$|K_0\rangle = \frac{1}{\sqrt{2}} (|K_S\rangle + |K_L\rangle)$$

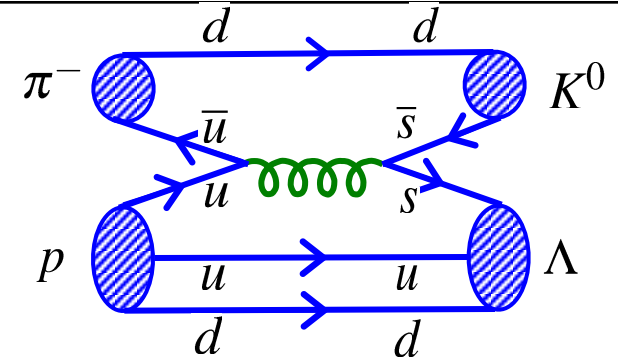

- Hence from the point of view of decays to pions, a  $K^0$  beam is a linear combination of CP eigenstates:
  - a rapidly decaying CP-even component and
  - a long-lived CP-odd component
- Therefore, expect to see predominantly two-pion decays near start of beam and predominantly three pion decays further downstream

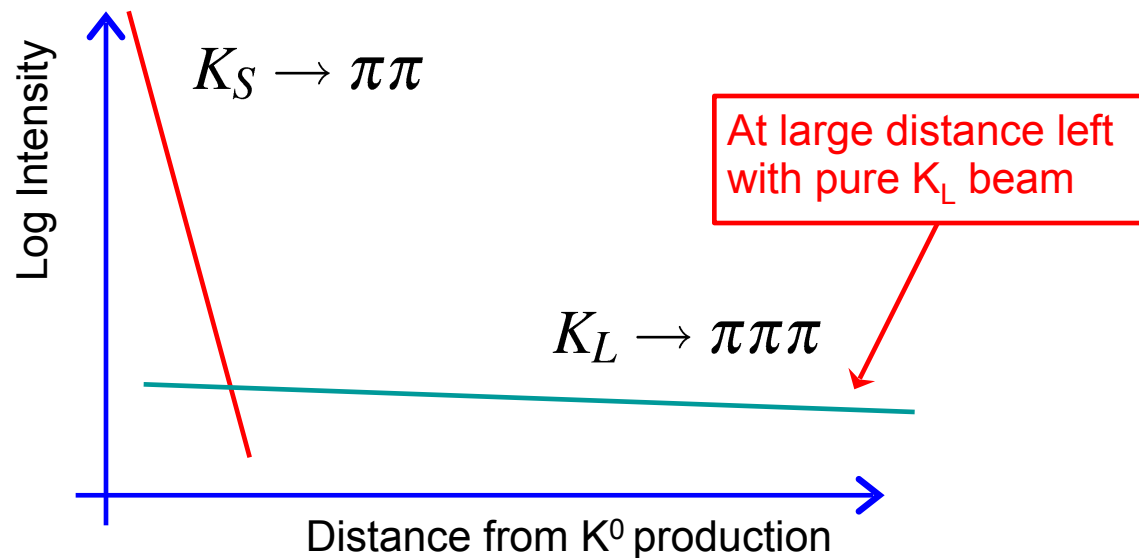



# Cronin, Fitch, Turlay experiment

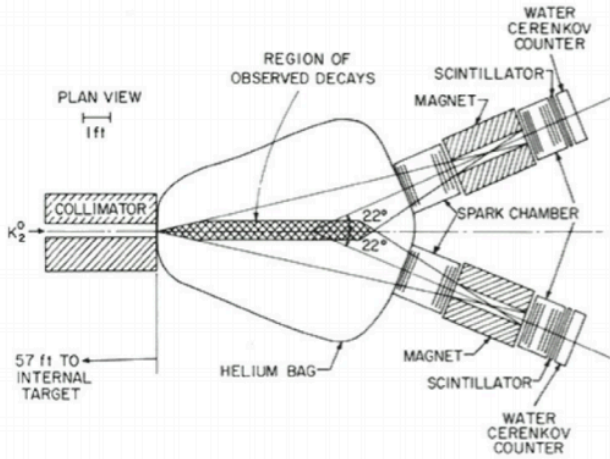

2-body decay (signal):

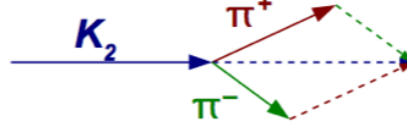

3-body decay (background):

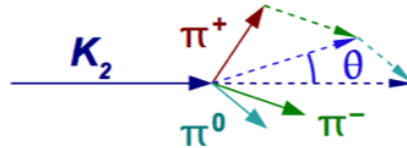

Low mass (peak around 350MeV)

$$K_L^0 \rightarrow \pi^+ \pi^- \pi^0$$

High mass

$$K_L^0 \rightarrow \pi \mu \nu \text{ and } K_L^0 \rightarrow \pi e \nu$$

- No evident discrepancy in the invariant mass
- Excess of  $49 \pm 9$  events when plotting the pointing angle in the kaon mass region

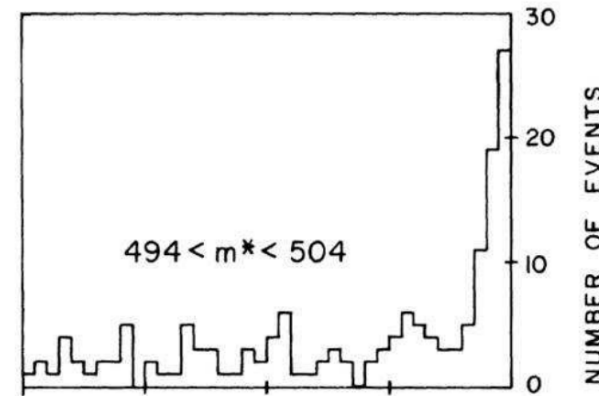
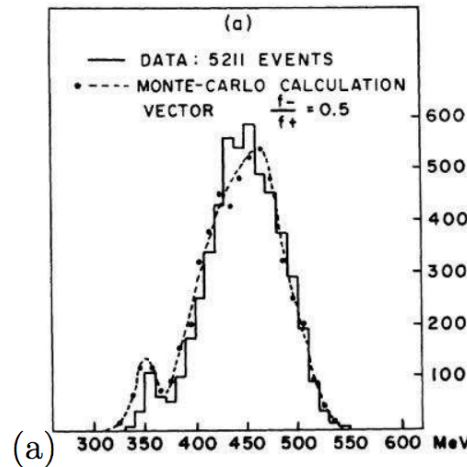
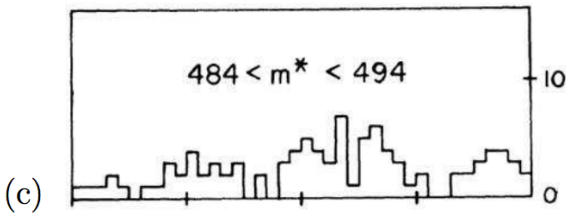

# Neutral Kaon Decays to Leptons

- Neutral kaons can also decay to leptons

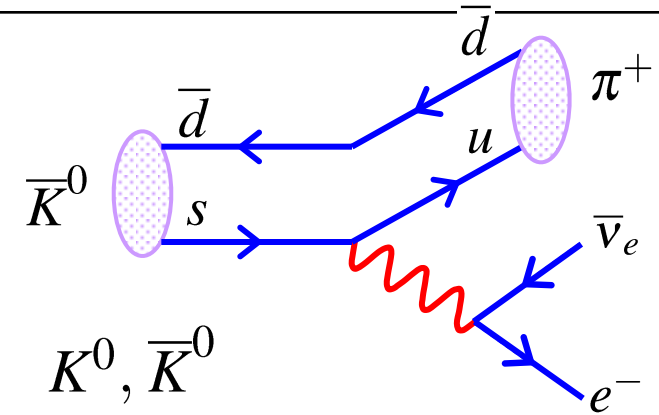
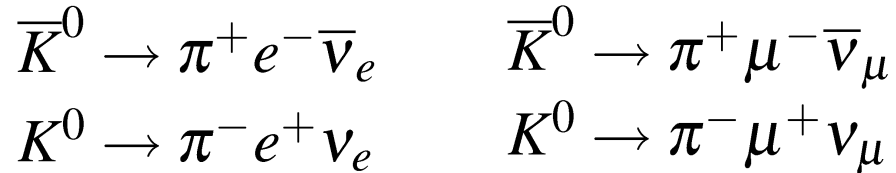

- **Note:** the final states are not CP eigenstates which is why we express these decays in terms of  $K^0, \bar{K}^0$
- Neutral kaons propagate as combined eigenstates of weak + strong interaction i.e. the  $K_S, K_L$ . The **main** decay modes/branching fractions are:

$K_S$	$\rightarrow \pi^+ \pi^-$	$BR = 69.2\%$
	$\rightarrow \pi^0 \pi^0$	$BR = 30.7\%$
	$\rightarrow \pi^- e^+ \nu_e$	$BR = 0.03\%$
	$\rightarrow \pi^+ e^- \bar{\nu}_e$	$BR = 0.03\%$
	$\rightarrow \pi^- \mu^+ \nu_\mu$	$BR = 0.02\%$
	$\rightarrow \pi^+ \mu^- \bar{\nu}_\mu$	$BR = 0.02\%$

$K_L$	$\rightarrow \pi^+ \pi^- \pi^0$	$BR = 12.6\%$
	$\rightarrow \pi^0 \pi^0 \pi^0$	$BR = 19.6\%$
	$\rightarrow \pi^- e^+ \nu_e$	$BR = 20.2\%$
	$\rightarrow \pi^+ e^- \bar{\nu}_e$	$BR = 20.2\%$
	$\rightarrow \pi^- \mu^+ \nu_\mu$	$BR = 13.5\%$
	$\rightarrow \pi^+ \mu^- \bar{\nu}_\mu$	$BR = 13.5\%$

- Leptonic decays are more likely for the K-long because the three pion decay modes have a lower decay rate than the two pion modes of the K-short

# Strangeness Oscillations (neglecting CP violation)

- The “semi-leptonic” decay rate to  $\pi^- e^+ \nu_e$  occurs from the  $K^0$  state. Hence to calculate the expected decay rate, need to know the  $K^0$  component of the wave-function. For example, for a beam which was initially  $K^0$  we have (1)

$$|\psi(t)\rangle = \frac{1}{\sqrt{2}}(\theta_S(t)|K_S\rangle + \theta_L(t)|K_L\rangle)$$

- Writing  $K_S, K_L$  in terms of  $K^0, \bar{K}^0$

$$\begin{aligned} |\psi(t)\rangle &= \frac{1}{2} \left[ \theta_S(t)(|K^0\rangle - |\bar{K}^0\rangle) + \theta_L(t)(|K^0\rangle + |\bar{K}^0\rangle) \right] \\ &= \frac{1}{2}(\theta_S + \theta_L)|K^0\rangle + \frac{1}{2}(\theta_L - \theta_S)|\bar{K}^0\rangle \end{aligned}$$

- Because  $\theta_S(t) \neq \theta_L(t)$  a state that was initially a  $K^0$  evolves with time into a mixture of  $K^0$  and  $\bar{K}^0$  - “strangeness oscillations”

- The  $K^0$  intensity (i.e.  $K^0$  fraction):

$$\Gamma(K_{t=0}^0 \rightarrow K^0) = |\langle K^0 | \psi(t) \rangle|^2 = \frac{1}{4} |\theta_S + \theta_L|^2 \quad (2)$$

- Similarly  $\Gamma(K_{t=0}^0 \rightarrow \bar{K}^0) = |\langle \bar{K}^0 | \psi(t) \rangle|^2 = \frac{1}{4} |\theta_S - \theta_L|^2 \quad (3)$

• **Using the identity**  $|z_1 \pm z_2|^2 = |z_1|^2 + |z_2|^2 \pm 2\Re(z_1 z_2^*)$

$$\begin{aligned}
|\theta_S \pm \theta_L|^2 &= |e^{-(im_S + \frac{1}{2}\Gamma_S)t} \pm e^{-(im_L + \frac{1}{2}\Gamma_L)t}|^2 \\
&= e^{-\Gamma_S t} + e^{-\Gamma_L t} \pm 2\Re\{e^{-im_S t} e^{-\frac{1}{2}\Gamma_S t} \cdot e^{+im_L t} e^{-\frac{1}{2}\Gamma_L t}\} \\
&= e^{-\Gamma_S t} + e^{-\Gamma_L t} \pm 2e^{-\frac{\Gamma_S + \Gamma_L}{2}t} \Re\{e^{-i(m_S - m_L)t}\} \\
&= e^{-\Gamma_S t} + e^{-\Gamma_L t} \pm 2e^{-\frac{\Gamma_S + \Gamma_L}{2}t} \cos(m_S - m_L)t \\
&= e^{-\Gamma_S t} + e^{-\Gamma_L t} \pm 2e^{-\frac{\Gamma_S + \Gamma_L}{2}t} \cos \Delta m t
\end{aligned}$$

- **Oscillations between neutral kaon states with frequency given by the mass splitting**

$$\Delta m = m(K_L) - m(K_S)$$

- **Reminiscent of neutrino oscillations ! Only this time we have **decaying states**.**
- **Using equations (2) and (3):**

$$\Gamma(K_{t=0}^0 \rightarrow K^0) = \frac{1}{4} \left[ e^{-\Gamma_S t} + e^{-\Gamma_L t} + 2e^{-(\Gamma_S + \Gamma_L)t/2} \cos \Delta m t \right] \quad (4)$$

$$\Gamma(K_{t=0}^0 \rightarrow \bar{K}^0) = \frac{1}{4} \left[ e^{-\Gamma_S t} + e^{-\Gamma_L t} - 2e^{-(\Gamma_S + \Gamma_L)t/2} \cos \Delta m t \right] \quad (5)$$

★ Strangeness oscillations can be studied by looking at semi-leptonic decays

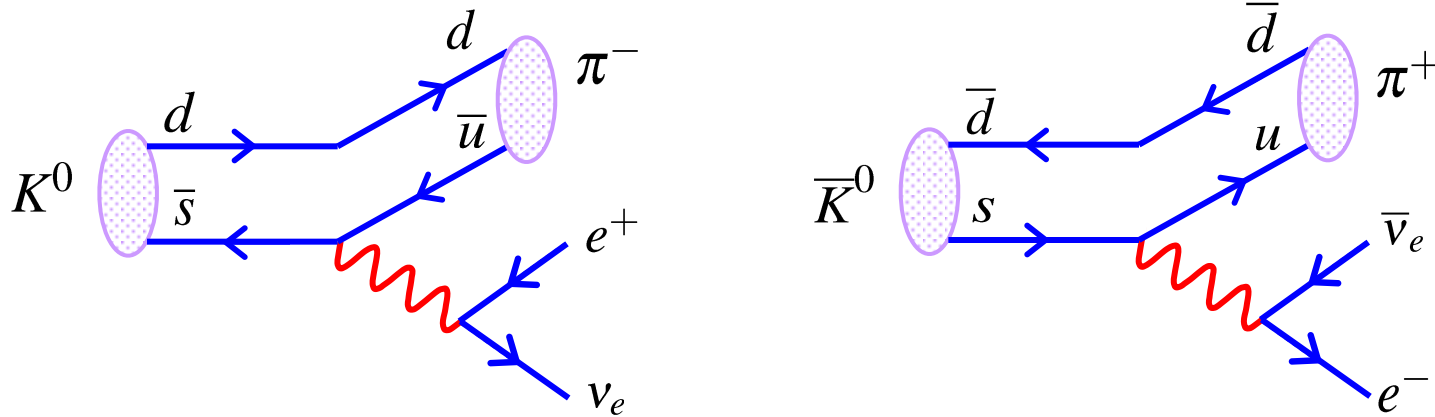

★ The charge of the observed pion (or lepton) tags the decay as from either a  $\bar{K}^0$  or  $K^0$  because

$$\begin{array}{l}
 K^0 \rightarrow \pi^- e^+ \nu_e \\
 \bar{K}^0 \rightarrow \pi^+ e^- \bar{\nu}_e
 \end{array}
 \quad \text{but} \quad
 \begin{array}{l}
 \bar{K}^0 \not\rightarrow \pi^- e^+ \nu_e \\
 K^0 \not\rightarrow \pi^+ e^- \bar{\nu}_e
 \end{array}
 \left. \vphantom{\begin{array}{l} K^0 \\ \bar{K}^0 \end{array}} \right\} \text{NOT ALLOWED}$$

- So for an initial  $K^0$  beam, observe the decays to both charge combinations:

$$\begin{array}{l}
 K_{t=0}^0 \rightarrow K^0 \\
 \quad \hookrightarrow \pi^- e^+ \nu_e
 \end{array}
 \qquad
 \begin{array}{l}
 K_{t=0}^0 \rightarrow \bar{K}^0 \\
 \quad \hookrightarrow \pi^+ e^- \bar{\nu}_e
 \end{array}$$

which provides a way of measuring strangeness oscillations

# The CPLEAR Experiment

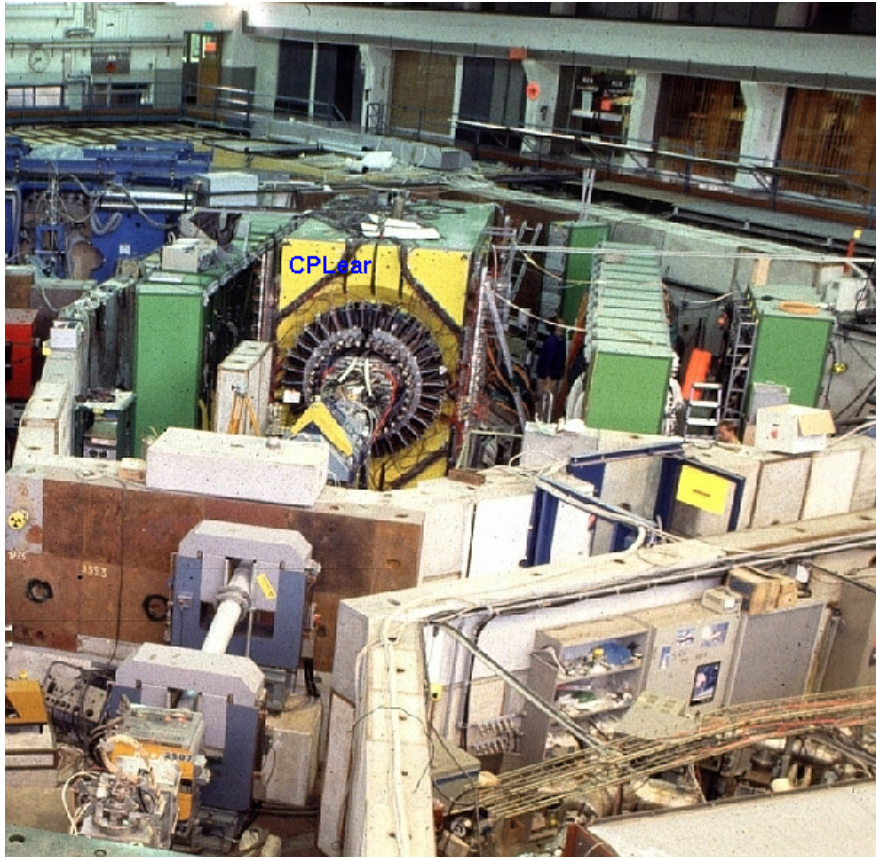

- CERN : 1990-1996
- Used a low energy **anti-proton** beam
- Neutral kaons produced in reactions

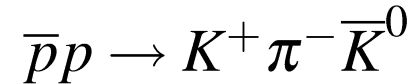
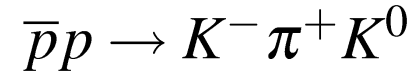

- Low energy, so particles produced almost at rest
- Observe production process and decay in the same detector
- Charge of  $K^\pm \pi^\mp$  in the production process tags the initial neutral kaon as either  $K^0$  or  $\bar{K}^0$

- Charge of decay products tags the decay as either as being either  $K^0$  or  $\bar{K}^0$
- Provides a direct probe of strangeness oscillations

## An example of a CPLEAR event

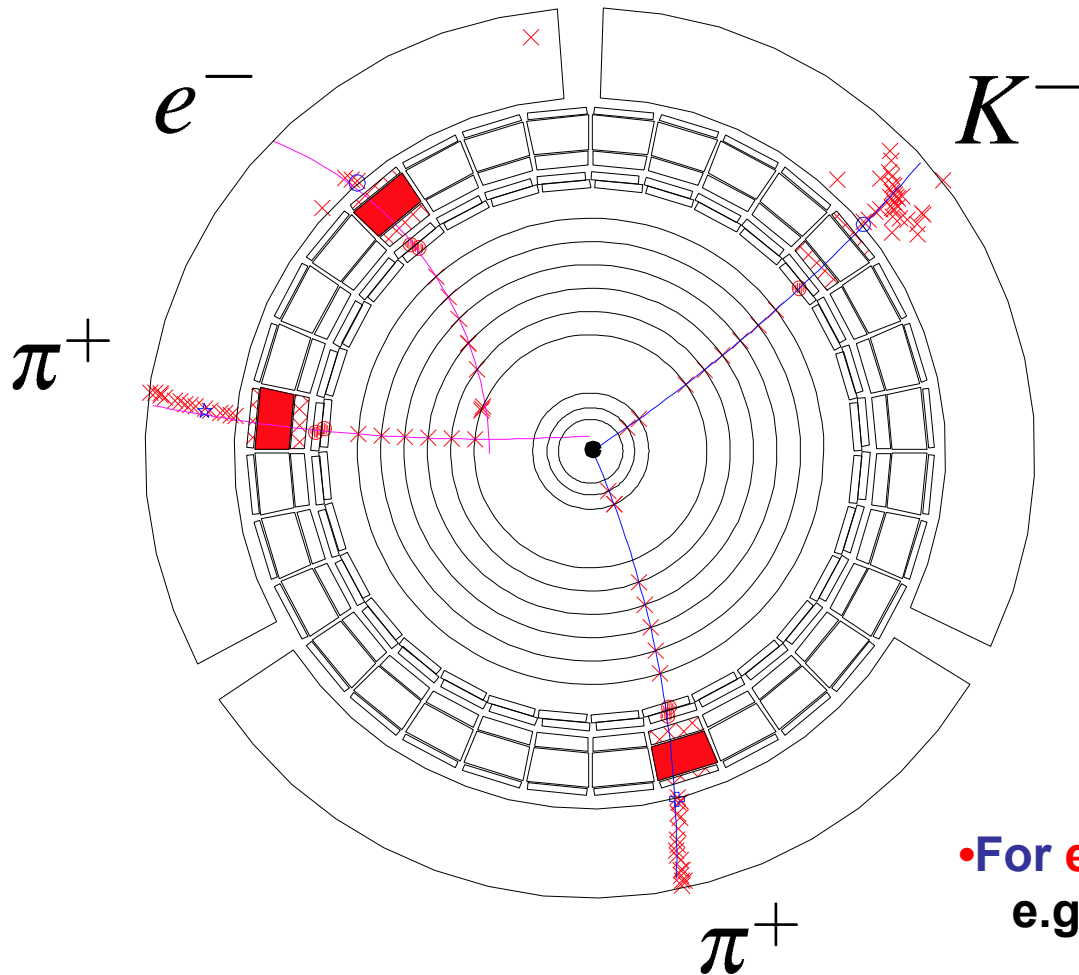

$$\begin{array}{l} K^- (s\bar{u}) \\ K^0 (d\bar{s}) \\ \bar{K}^0 (s\bar{d}) \end{array}$$

**Production:**

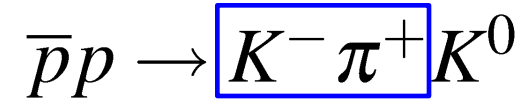

**Decay:**

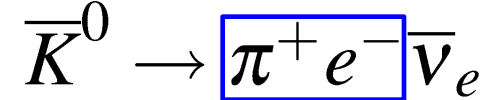

Mixing

- **For each event** know initial wave-function, e.g. here:  $|\psi(t=0)\rangle = |K^0\rangle$

- Can measure decay rates as a function of time for all combinations:

e.g.  $R^+ = \Gamma(K_{t=0}^0 \rightarrow \pi^- e^+ \bar{\nu}_e) \propto \Gamma(K_{t=0}^0 \rightarrow K^0)$

- From equations (4), (5) and similar relations:

$$R_+ \equiv \Gamma(K_{t=0}^0 \rightarrow \pi^- e^+ \nu_e) = N_{\pi e \nu} \frac{1}{4} \left[ e^{-\Gamma_S t} + e^{-\Gamma_L t} + 2e^{-(\Gamma_S + \Gamma_L)t/2} \cos \Delta m t \right]$$

$$R_- \equiv \Gamma(K_{t=0}^0 \rightarrow \pi^+ e^- \bar{\nu}_e) = N_{\pi e \nu} \frac{1}{4} \left[ e^{-\Gamma_S t} + e^{-\Gamma_L t} - 2e^{-(\Gamma_S + \Gamma_L)t/2} \cos \Delta m t \right]$$

$$\bar{R}_- \equiv \Gamma(\bar{K}_{t=0}^0 \rightarrow \pi^+ e^- \bar{\nu}_e) = N_{\pi e \nu} \frac{1}{4} \left[ e^{-\Gamma_S t} + e^{-\Gamma_L t} + 2e^{-(\Gamma_S + \Gamma_L)t/2} \cos \Delta m t \right]$$

$$\bar{R}_+ \equiv \Gamma(\bar{K}_{t=0}^0 \rightarrow \pi^- e^+ \nu_e) = N_{\pi e \nu} \frac{1}{4} \left[ e^{-\Gamma_S t} + e^{-\Gamma_L t} - 2e^{-(\Gamma_S + \Gamma_L)t/2} \cos \Delta m t \right]$$

where  $N_{\pi e \nu}$  is some overall normalisation factor

- Express measurements as an “asymmetry” to remove dependence on  $N_{\pi e \nu}$

$$A_{\Delta m} = \frac{(R_+ + \bar{R}_-) - (R_- + \bar{R}_+)}{(R_+ + \bar{R}_-) + (R_- + \bar{R}_+)}$$



- Using the above expressions for  $R_+$  etc., obtain

$$A_{\Delta m} = \frac{2e^{-(\Gamma_S + \Gamma_L)t/2} \cos \Delta m t}{e^{-\Gamma_S t} + e^{-\Gamma_L t}}$$

A. Angelopoulos et al., Eur. Phys. J. C22 (2001) 55

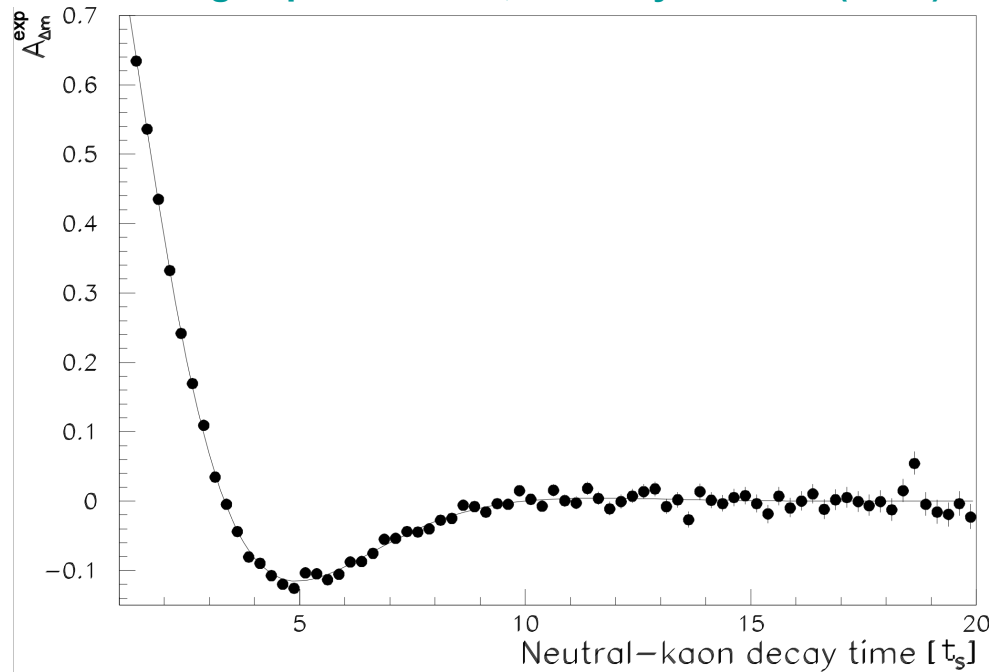

- ★ Points show the data
- ★ The line shows the theoretical prediction for the value of  $\Delta m$  most consistent with the CPLEAR data:

$$\Delta m = 3.485 \times 10^{-15} \text{ GeV}$$

- The sign of  $\Delta m$  is not determined here but is known from other experiments
- When the CPLEAR results are combined with experiments at FermiLab obtain:

$$\Delta m = m(K_L) - m(K_S) = (3.506 \pm 0.006) \times 10^{-15} \text{ GeV}$$

# CP Violation in Semi-leptonic decays

- ★ If observe a neutral kaon beam a long time after production (i.e. a large distances) it will consist of a pure  $K_L$  component

$$|K_L\rangle = \frac{1}{\sqrt{2}} \frac{1}{\sqrt{1+|\varepsilon|^2}} \left[ (1 + \varepsilon) |K^0\rangle + (1 - \varepsilon) |\bar{K}^0\rangle \right]$$

$\swarrow \quad \searrow$   
 $\pi^+ e^- \bar{\nu}_e \quad \pi^- e^+ \nu_e$

- ★ Decays to  $\pi^- e^+ \nu_e$  must come from the  $\bar{K}^0$  component, and decays to  $\pi^+ e^- \bar{\nu}_e$  must come from the  $K^0$  component

$$\Gamma(K_L \rightarrow \pi^+ e^- \bar{\nu}_e) \propto |\langle \bar{K}^0 | K_L \rangle|^2 \propto |1 - \varepsilon|^2 \approx 1 - 2\Re\{\varepsilon\}$$

$$\Gamma(K_L \rightarrow \pi^- e^+ \nu_e) \propto |\langle K^0 | K_L \rangle|^2 \propto |1 + \varepsilon|^2 \approx 1 + 2\Re\{\varepsilon\}$$

- ★ Results in a small difference in decay rates: the decay to  $\pi^- e^+ \nu_e$  is **0.7 % more likely** than the decay to  $\pi^+ e^- \bar{\nu}_e$ 
  - This difference has been observed and thus provides the first direct evidence for an absolute difference between matter and anti-matter.
- ★ It also provides an unambiguous definition of matter which could, for example, be transmitted to aliens in a distant galaxy

**“The electrons in our atoms have the same charge as those emitted least often in the decays of the long-lived neutral kaon”**

# Appendix I: Determination of the CKM Matrix

Non-examinable

- The experimental determination of the **CKM matrix** elements comes mainly from measurements of leptonic decays (the leptonic part is well understood).
- It is easy to produce/observe meson decays, however theoretical uncertainties associated with the decays of bound states often limits the precision
- Contrast this with the measurements of the **PMNS matrix**, where there are few theoretical uncertainties and the experimental difficulties in dealing with neutrinos limits the precision.

①

$$|V_{ud}|$$

from nuclear beta decay

$$\begin{pmatrix} \times & \dots \\ \cdot & \dots \\ \cdot & \dots \end{pmatrix}$$

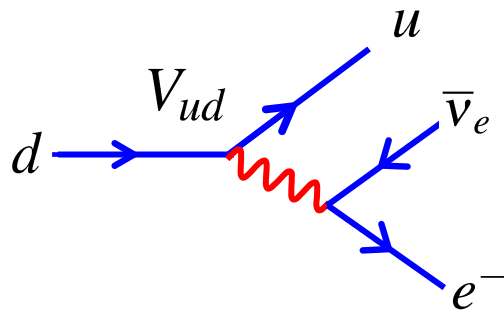

Super-allowed  $0^+ \rightarrow 0^+$  beta decays are relatively free from theoretical uncertainties

$$\Gamma \propto |V_{ud}|^2$$

$$|V_{ud}| = 0.97377 \pm 0.00027$$

$$(\approx \cos \theta_c)$$

2

$|V_{us}|$

from semi-leptonic kaon decays

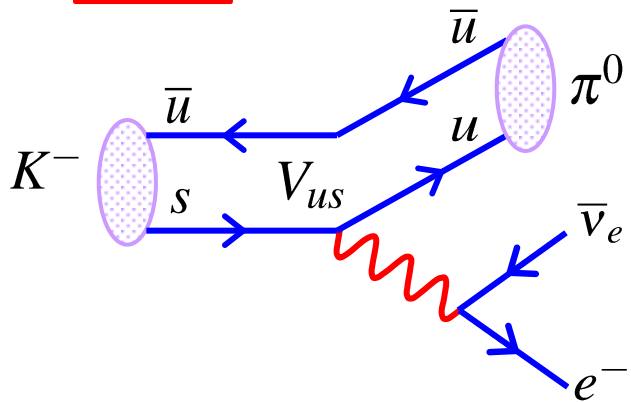

$\Gamma \propto |V_{us}|^2$

$$\begin{pmatrix} \cdot & \times & \cdot \\ \cdot & \cdot & \cdot \\ \cdot & \cdot & \cdot \end{pmatrix}$$

$|V_{us}| = 0.2257 \pm 0.0021$

( $\approx \sin \theta_c$ )

3

$|V_{cd}|$

from neutrino scattering

$\nu_\mu + N \rightarrow \mu^+ \mu^- X$

$$\begin{pmatrix} \cdot & \cdot & \cdot \\ \times & \cdot & \cdot \\ \cdot & \cdot & \cdot \end{pmatrix}$$

Look for opposite charge di-muon events in  $\nu_\mu$  scattering from production and decay of a  $D^+(c\bar{d})$  meson

Rate  $\propto |V_{cd}|^2 \text{Br}(D^+ \rightarrow X \mu^+ \nu_\mu)$

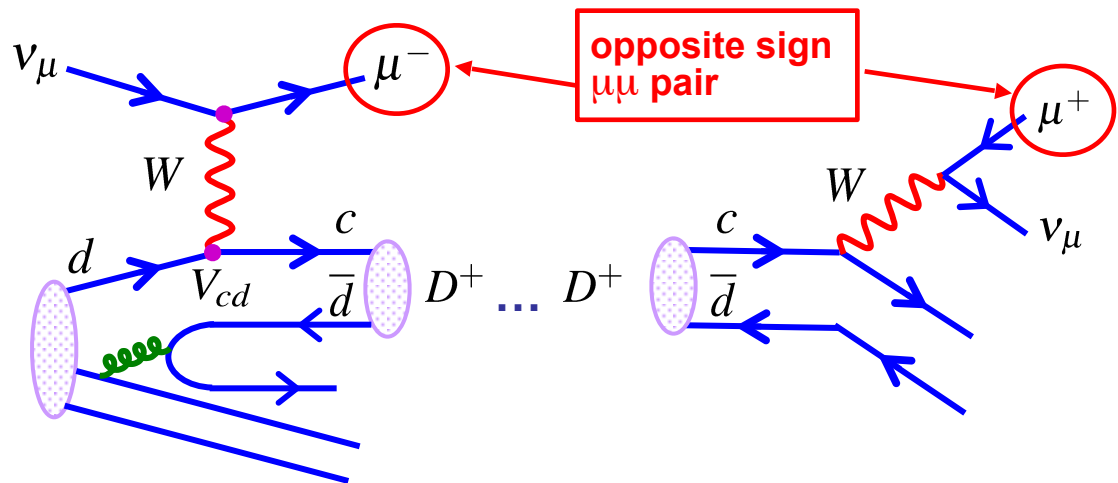

Measured in various collider experiments

$|V_{cd}| = 0.230 \pm 0.011$

④  $|V_{cs}|$  from semi-leptonic charmed meson decays

$$\begin{pmatrix} \cdot & \cdot & \cdot \\ \cdot & \times & \cdot \\ \cdot & \cdot & \cdot \end{pmatrix}$$

e.g.

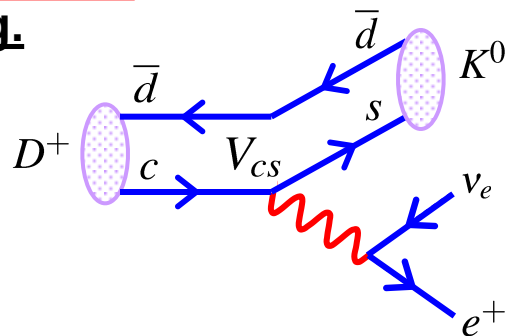

$$\Gamma \propto |V_{cs}|^2$$

• Precision limited by theoretical uncertainties

$$|V_{cs}| = 0.957 \pm 0.017 \pm 0.093$$

experimental error

theory uncertainty

⑤  $|V_{cb}|$  from semi-leptonic B hadron decays

$$\begin{pmatrix} \cdot & \cdot & \cdot \\ \cdot & \cdot & \times \\ \cdot & \cdot & \cdot \end{pmatrix}$$

e.g.

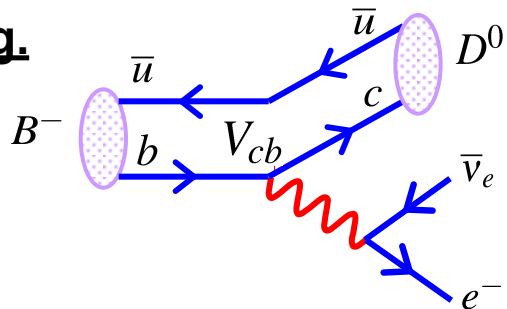

$$\Gamma \propto |V_{cb}|^2$$

$$|V_{cb}| = 0.0416 \pm 0.0006$$

⑥  $|V_{ub}|$  from semi-leptonic B hadron decays

$$\begin{pmatrix} \cdot & \cdot & \times \\ \cdot & \cdot & \cdot \\ \cdot & \cdot & \cdot \end{pmatrix}$$

e.g.

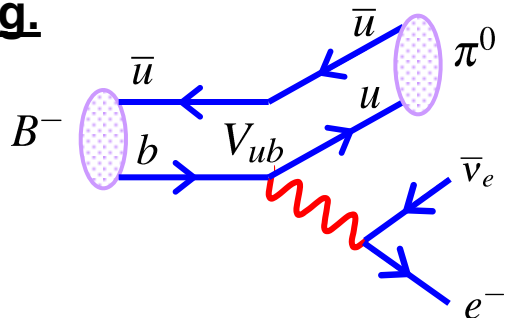

$$\Gamma \propto |V_{ub}|^2$$

$$|V_{ub}| = 0.0043 \pm 0.0003$$

# Appendix II: Particle – Anti-Particle Mixing

- The wave-function for a single particle with lifetime  $\tau = 1/\Gamma$  evolves with time as:

$$\psi(t) = N e^{-\Gamma t/2} e^{-iMt}$$

which gives the appropriate exponential decay of

$$\langle \psi(t) | \psi(t) \rangle = \langle \psi(0) | \psi(0) \rangle e^{-t/\tau}$$

- The wave-function satisfies the time-dependent wave equation:

$$\hat{H}|\psi(t)\rangle = \left(M - \frac{1}{2}i\Gamma\right)|\psi(t)\rangle = i\frac{\partial}{\partial t}|\psi(t)\rangle \quad (\text{A1})$$

- For a bound state such as a  $K^0$  the mass term includes the “mass” from the weak interaction “potential”  $\hat{H}_{\text{weak}}$

$$M = m_{K^0} + \langle K^0 | \hat{H}_{\text{weak}} | K^0 \rangle + \sum_j \frac{|\langle K^0 | \hat{H}_{\text{weak}} | j \rangle|^2}{m_{K^0} - E_j}$$

Sum over intermediate states  $j$

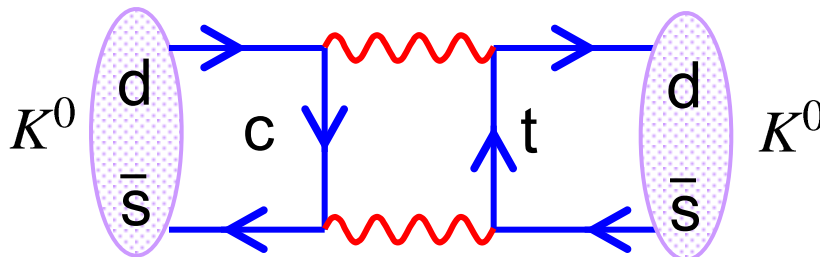

The third term is the 2<sup>nd</sup> order term in the perturbation expansion corresponding to box diagrams resulting in  $K^0 \rightarrow K^0$

- The total decay rate is the sum over all possible decays  $K^0 \rightarrow f$

$$\Gamma = 2\pi \sum_f |\langle f | \hat{H}_{weak} | K^0 \rangle|^2 \rho_F \leftarrow \text{Density of final states}$$

- ★ Because there are also diagrams which allow  $K^0 \leftrightarrow \bar{K}^0$  mixing need to consider the time evolution of a mixed stated

$$\psi(t) = a(t)K^0 + b(t)\bar{K}^0 \quad (\text{A2})$$

- ★ The time dependent wave-equation of (A1) becomes

$$\begin{pmatrix} M_{11} - \frac{1}{2}i\Gamma_{11} & M_{12} - \frac{1}{2}i\Gamma_{12} \\ M_{21} - \frac{1}{2}i\Gamma_{21} & M_{22} - \frac{1}{2}i\Gamma_{22} \end{pmatrix} \begin{pmatrix} |K^0(t)\rangle \\ |\bar{K}^0(t)\rangle \end{pmatrix} = i \frac{\partial}{\partial t} \begin{pmatrix} |K^0(t)\rangle \\ |\bar{K}^0(t)\rangle \end{pmatrix} \quad (\text{A3})$$

the diagonal terms are as before, and the off-diagonal terms are due to mixing.

$$M_{11} = m_{K^0} + \langle K^0 | \hat{H}_{weak} | K^0 \rangle + \sum_n \frac{|\langle K^0 | \hat{H}_{weak} | K^0 \rangle|^2}{m_{K^0} - E_n}$$

$$M_{12} = \sum_j \frac{\langle K^0 | \hat{H}_{weak} | j \rangle^* \langle j | \hat{H}_{weak} | \bar{K}^0 \rangle}{m_{K^0} - E_j}$$

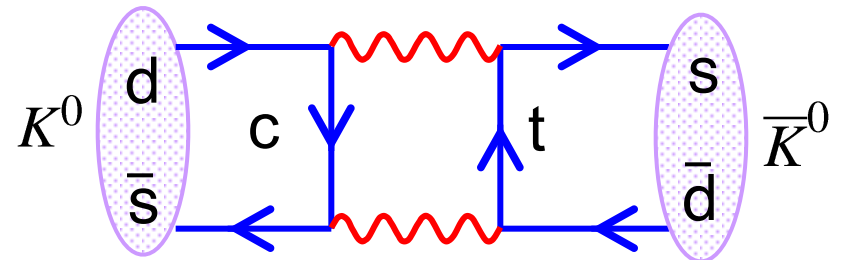

- The off-diagonal decay terms include the effects of interference between decays to a common final state

$$\Gamma_{12} = 2\pi \sum_f \langle f | \hat{H}_{weak} | K^0 \rangle^* \langle f | \hat{H}_{weak} | \bar{K}^0 \rangle \rho_F$$

- In terms of the time dependent coefficients for the kaon states, (A3) becomes

$$[\mathbf{M} - i\frac{1}{2}\Gamma] \begin{pmatrix} a \\ b \end{pmatrix} = i\frac{\partial}{\partial t} \begin{pmatrix} a \\ b \end{pmatrix}$$

where the Hamiltonian can be written:

$$\mathbf{H} = \mathbf{M} - i\frac{1}{2}\Gamma = \begin{pmatrix} M_{11} & M_{12} \\ M_{21} & M_{22} \end{pmatrix} - \frac{1}{2} \begin{pmatrix} \Gamma_{11} & \Gamma_{12} \\ \Gamma_{21} & \Gamma_{22} \end{pmatrix}$$

- Both the mass and decay matrices represent observable quantities and are Hermitian

$$M_{11} = M_{11}^*, \quad M_{22} = M_{22}^*, \quad M_{12} = M_{21}^*$$

$$\Gamma_{11} = \Gamma_{11}^*, \quad \Gamma_{22} = \Gamma_{22}^*, \quad \Gamma_{12} = \Gamma_{21}^*$$

- Furthermore, if CPT is conserved then the masses and decay rates of the  $K^0$  and  $\bar{K}^0$  are identical:

$$M_{11} = M_{22} = M; \quad \Gamma_{11} = \Gamma_{22} = \Gamma$$



- Hence the time evolution of the system can be written:

$$\boxed{\begin{pmatrix} M - \frac{1}{2}i\Gamma & M_{12} - \frac{1}{2}i\Gamma_{12} \\ M_{12}^* - \frac{1}{2}i\Gamma_{12}^* & M - \frac{1}{2}i\Gamma \end{pmatrix} \begin{pmatrix} a \\ b \end{pmatrix} = i \frac{\partial}{\partial t} \begin{pmatrix} a \\ b \end{pmatrix}} \quad (\text{A4})$$

- To solve the coupled differential equations for  $a(t)$  and  $b(t)$ , first find the eigenstates of the Hamiltonian (the  $K_L$  and  $K_S$ ) and then transform into this basis. The eigenvalue equation is:

$$\begin{pmatrix} M - \frac{1}{2}i\Gamma & M_{12} - \frac{1}{2}i\Gamma_{12} \\ M_{12}^* - \frac{1}{2}i\Gamma_{12}^* & M - \frac{1}{2}i\Gamma \end{pmatrix} \begin{pmatrix} x_1 \\ x_2 \end{pmatrix} = \lambda \begin{pmatrix} x_1 \\ x_2 \end{pmatrix} \quad (\text{A5})$$

- Which has non-trivial solutions for

$$|\mathbf{H} - \lambda I| = 0$$

$$\Rightarrow \left(M - \frac{1}{2}i\Gamma - \lambda\right)^2 - \left(M_{12}^* - \frac{1}{2}i\Gamma_{12}^*\right)\left(M_{12} - \frac{1}{2}i\Gamma_{12}\right) = 0$$

with eigenvalues

$$\lambda = M - \frac{1}{2}i\Gamma \pm \sqrt{\left(M_{12}^* - \frac{1}{2}i\Gamma_{12}^*\right)\left(M_{12} - \frac{1}{2}i\Gamma_{12}\right)}$$

- The eigenstates can be obtained by substituting back into (A5)

$$(M - \frac{1}{2}i\Gamma)x_1 + (M_{12} - \frac{1}{2}i\Gamma_{12}) = (M - \frac{1}{2}i\Gamma \pm \sqrt{(M_{12}^* - \frac{1}{2}i\Gamma_{12}^*)(M_{12} - \frac{1}{2}i\Gamma_{12})})x_1$$

$$\Rightarrow \frac{x_2}{x_1} = \pm \sqrt{\frac{M_{12}^* - \frac{1}{2}i\Gamma_{12}^*}{M_{12} - \frac{1}{2}i\Gamma_{12}}}$$

★ Define

$$\eta = \sqrt{\frac{M_{12}^* - \frac{1}{2}i\Gamma_{12}^*}{M_{12} - \frac{1}{2}i\Gamma_{12}}}$$

★ Hence the normalised eigenstates are

$$|K_{\pm}\rangle = \frac{1}{\sqrt{1 + |\eta|^2}} \begin{pmatrix} 1 \\ \pm\eta \end{pmatrix} = \frac{1}{\sqrt{1 + |\eta|^2}} (|K^0\rangle \pm \eta|\bar{K}^0\rangle)$$

★ Note, in the limit where  $M_{12}, \Gamma_{12}$  are real, the eigenstates correspond to the CP eigenstates  $K_1$  and  $K_2$ . Hence we can identify the general eigenstates as the long and short lived neutral kaons:

$$|K_L\rangle = \frac{1}{\sqrt{1 + |\eta|^2}} (|K^0\rangle + \eta|\bar{K}^0\rangle) \quad |K_S\rangle = \frac{1}{\sqrt{1 + |\eta|^2}} (|K^0\rangle - \eta|\bar{K}^0\rangle)$$

★ Substituting these states back into (A2):

$$\begin{aligned} |\psi(t)\rangle &= a(t)|K^0\rangle + b(t)|\bar{K}^0\rangle \\ &= \sqrt{1 + |\eta|^2} \left[ \frac{a(t)}{2} (K_L + K_S) + \frac{b(t)}{2\eta} (K_L - K_S) \right] \\ &= \sqrt{1 + |\eta|^2} \left[ \left( \frac{a(t)}{2} + \frac{b(t)}{2\eta} \right) K_L + \left( \frac{a(t)}{2} - \frac{b(t)}{2\eta} \right) K_S \right] \\ &= \frac{\sqrt{1 + |\eta|^2}}{2} [a_L(t)K_L + a_S(t)K_S] \end{aligned}$$

with

$$a_L(t) \equiv a(t) + \frac{b(t)}{\eta}$$

$$a_S(t) \equiv a(t) - \frac{b(t)}{\eta}$$

★ Now consider the time evolution of  $a_L(t)$

$$i \frac{\partial a_L}{\partial t} = i \frac{\partial a}{\partial t} + \frac{i}{\eta} \frac{\partial b}{\partial t}$$

★ Which can be evaluated using (A4) for the time evolution of  $a(t)$  and  $b(t)$ :

$$\begin{aligned}
i\frac{\partial a_L}{\partial t} &= \left[ (M - \frac{1}{2}i\Gamma_{12})a + (M_{12} - \frac{1}{2}i\Gamma_{12})b \right] + \frac{1}{\eta} \left[ (M_{12}^* - \frac{1}{2}i\Gamma_{12}^*)a + (M - \frac{1}{2}i\Gamma)b \right] \\
&= (M - \frac{1}{2}i\Gamma) \left( a + \frac{b}{\eta} \right) + (M_{12} - \frac{1}{2}i\Gamma_{12})b + \frac{1}{\eta} (M_{12}^* - \frac{1}{2}i\Gamma_{12}^*)a \\
&= (M - \frac{1}{2}i\Gamma)a_L + (M_{12} - \frac{1}{2}i\Gamma_{12})b + \left( \sqrt{(M_{12}^* - \frac{1}{2}i\Gamma_{12}^*)(M_{12} - \frac{1}{2}i\Gamma_{12})} \right) a \\
&= (M - \frac{1}{2}i\Gamma)a_L + \left( \sqrt{(M_{12}^* - \frac{1}{2}i\Gamma_{12}^*)(M_{12} - \frac{1}{2}i\Gamma_{12})} \right) \left( a + \frac{b}{\eta} \right) \\
&= (M - \frac{1}{2}i\Gamma)a_L + \left( \sqrt{(M_{12}^* - \frac{1}{2}i\Gamma_{12}^*)(M_{12} - \frac{1}{2}i\Gamma_{12})} \right) a_L \\
&= (m_L - \frac{1}{2}i\Gamma_L)a_L
\end{aligned}$$

★ Hence:

$$i\frac{\partial a_L}{\partial t} = (m_L - \frac{1}{2}i\Gamma_L)a_L$$

with  $m_L = M + \Re \left\{ \sqrt{(M_{12}^* - \frac{1}{2}i\Gamma_{12}^*)(M_{12} - \frac{1}{2}i\Gamma_{12})} \right\}$

and  $\Gamma_L = \Gamma - 2\Im \left\{ \sqrt{(M_{12}^* - \frac{1}{2}i\Gamma_{12}^*)(M_{12} - \frac{1}{2}i\Gamma_{12})} \right\}$

★ Following the same procedure obtain:

$$i \frac{\partial a_S}{\partial t} = (m_S - \frac{1}{2} i \Gamma_S) a_S$$

with  $m_S = M - \Re \left\{ \sqrt{(M_{12}^* - \frac{1}{2} i \Gamma_{12}^*)(M_{12} - \frac{1}{2} i \Gamma_{12})} \right\}$

and  $\Gamma_S = \Gamma + 2\Im \left\{ \sqrt{(M_{12}^* - \frac{1}{2} i \Gamma_{12}^*)(M_{12} - \frac{1}{2} i \Gamma_{12})} \right\}$

★ In matrix notation we have

$$\begin{pmatrix} M_L - \frac{1}{2} i \Gamma_L & 0 \\ 0 & M_S - \frac{1}{2} i \Gamma_S \end{pmatrix} \begin{pmatrix} a_L \\ a_S \end{pmatrix} = i \frac{\partial}{\partial t} \begin{pmatrix} a_L \\ a_S \end{pmatrix}$$

★ Solving we obtain

$$a_L(t) \propto e^{-im_L t - \Gamma_L t/2} \quad a_S(t) \propto e^{-im_S t - \Gamma_S t/2}$$

★ Hence in terms of the  $K_L$  and  $K_S$  basis the states propagate as independent particles with definite masses and lifetimes (**the mass eigenstates**). The time evolution of the neutral kaon system can be written

$$|\psi(t)\rangle = A_L e^{-im_L t - \Gamma_L t/2} |K_L\rangle + A_S e^{-im_S t - \Gamma_S t/2} |K_S\rangle$$

where  $A_L$  and  $A_S$  are constants

- ★ Consider the development of the  $K^0 - \bar{K}^0$  system **now** including CP violation
- ★ Repeat previous derivation using

$$|K_S\rangle = \frac{1}{\sqrt{1+|\varepsilon|^2}} [ |K_1\rangle + \varepsilon |K_2\rangle ] \quad |K_L\rangle = \frac{1}{\sqrt{1+|\varepsilon|^2}} [ |K_2\rangle + \varepsilon |K_1\rangle ]$$

- Writing the CP eigenstates in terms of  $K^0, \bar{K}^0$

$$|K_L\rangle = \frac{1}{\sqrt{2}} \frac{1}{\sqrt{1+|\varepsilon|^2}} [ (1+\varepsilon) |K_0\rangle + (1-\varepsilon) |\bar{K}^0\rangle ]$$

$$|K_S\rangle = \frac{1}{\sqrt{2}} \frac{1}{\sqrt{1+|\varepsilon|^2}} [ (1+\varepsilon) |K_0\rangle - (1-\varepsilon) |\bar{K}^0\rangle ]$$

- Inverting these expressions obtain

$$|K^0\rangle = \sqrt{\frac{1+|\varepsilon|^2}{2}} \frac{1}{1+\varepsilon} (|K_L\rangle + |K_S\rangle)$$

$$|\bar{K}^0\rangle = \sqrt{\frac{1+|\varepsilon|^2}{2}} \frac{1}{1-\varepsilon} (|K_L\rangle - |K_S\rangle)$$

- Hence a state that was produced as a  $K^0$  evolves with time as:

$$|\psi(t)\rangle = \sqrt{\frac{1+|\varepsilon|^2}{2}} \frac{1}{1+\varepsilon} (\theta_L(t) |K_L\rangle + \theta_S(t) |K_S\rangle)$$

where as before  $\theta_S(t) = e^{-(im_S + \frac{\Gamma_S}{2})t}$  and  $\theta_L(t) = e^{-(im_L + \frac{\Gamma_L}{2})t}$

- If we are considering the decay rate to  $\pi\pi$  need to express the wave-function in terms of the CP eigenstates (remember we are neglecting CP violation in the decay)

$$\begin{aligned}
 |\psi(t)\rangle &= \frac{1}{\sqrt{2}} \frac{1}{1+\varepsilon} [ (|K_2\rangle + \varepsilon|K_1\rangle)\theta_L(t) + (|K_1\rangle + \varepsilon|K_2\rangle)\theta_S(t) ] \\
 &= \frac{1}{\sqrt{2}} \frac{1}{1+\varepsilon} [ (\theta_S + \varepsilon\theta_L)|K_1\rangle + (\theta_L + \varepsilon\theta_S)|K_2\rangle ]
 \end{aligned}$$

CP Eigenstates

- Two pion decays occur with CP = +1 and therefore arise from decay of the CP = +1 kaon eigenstate, i.e.  $K_1$

$$\Gamma(K_{t=0}^0 \rightarrow \pi\pi) \propto |\langle K_1 | \psi(t) \rangle|^2 = \frac{1}{2} \left| \frac{1}{1+\varepsilon} \right|^2 |\theta_S + \varepsilon\theta_L|^2$$

- Since  $|\varepsilon| \ll 1$

$$\left| \frac{1}{1+\varepsilon} \right|^2 = \frac{1}{(1+\varepsilon^*)(1+\varepsilon)} \approx \frac{1}{1+2\Re\{\varepsilon\}} \approx 1 - 2\Re\{\varepsilon\}$$

- Now evaluate the  $|\theta_S + \varepsilon\theta_L|^2$  term again using

$$|z_1 \pm z_2|^2 = |z_1|^2 + |z_2|^2 \pm 2\Re(z_1 z_2^*)$$

$$\begin{aligned}
 |\theta_S + \varepsilon\theta_L|^2 &= \left| e^{-im_S t - \frac{\Gamma_S}{2}t} + \varepsilon e^{-im_L t - \frac{\Gamma_L}{2}t} \right|^2 \\
 &= e^{-\Gamma_S t} + |\varepsilon|^2 e^{-\Gamma_L t} + 2\Re\left\{ e^{-im_S t - \frac{\Gamma_S}{2}t} \cdot \varepsilon^* e^{+im_L t - \frac{\Gamma_L}{2}t} \right\}
 \end{aligned}$$

• **Writing**  $\varepsilon = |\varepsilon|e^{i\phi}$

$$\begin{aligned}
 |\theta_S + \varepsilon\theta_L|^2 &= e^{-\Gamma_S t} + |\varepsilon|^2 e^{-\Gamma_L t} + 2|\varepsilon|e^{-(\Gamma_S + \Gamma_L)t/2} \Re\left\{ e^{i(m_L - m_S)t - \phi} \right\} \\
 &= e^{-\Gamma_S t} + |\varepsilon|^2 e^{-\Gamma_L t} + 2|\varepsilon|e^{-(\Gamma_S + \Gamma_L)t/2} \cos(\Delta m \cdot t - \phi)
 \end{aligned}$$

• **Putting this together we obtain:**

$$\Gamma(K_{t=0}^0 \rightarrow \pi\pi) = \frac{1}{2}(1 - 2\Re\{\varepsilon\})N_{\pi\pi} \left[ e^{-\Gamma_S t} + |\varepsilon|^2 e^{-\Gamma_L t} + 2|\varepsilon|e^{-(\Gamma_S + \Gamma_L)t/2} \cos(\Delta m \cdot t - \phi) \right]$$

**Short lifetime component**  
 $K_S \rightarrow \pi\pi$

**CP violating long lifetime component**  
 $K_L \rightarrow \pi\pi$

**Interference term**

• **In exactly the same manner obtain for a beam which was produced as  $\bar{K}^0$**

$$\Gamma(\bar{K}_{t=0}^0 \rightarrow \pi\pi) = \frac{1}{2}(1 + 2\Re\{\varepsilon\})N_{\pi\pi} \left[ e^{-\Gamma_S t} + |\varepsilon|^2 e^{-\Gamma_L t} - 2|\varepsilon|e^{-(\Gamma_S + \Gamma_L)t/2} \cos(\Delta m \cdot t - \phi) \right]$$

**Interference term changes sign**



★ At large proper times only the long lifetime component remains :

$$\Gamma(K_{t=0}^0 \rightarrow \pi\pi) \rightarrow \frac{1}{2}(1 - 2\Re\{\varepsilon\})N_{\pi\pi} \cdot |\varepsilon|^2 e^{-\Gamma_L t}$$

i.e. CP violating  $K_L \rightarrow \pi\pi$  decays

★ Since CPLEAR can identify whether a  $K^0$  or  $\bar{K}^0$  was produced, able to measure  $\Gamma(K_{t=0}^0 \rightarrow \pi\pi)$  and  $\Gamma(\bar{K}_{t=0}^0 \rightarrow \pi\pi)$

### Prediction with CP violation

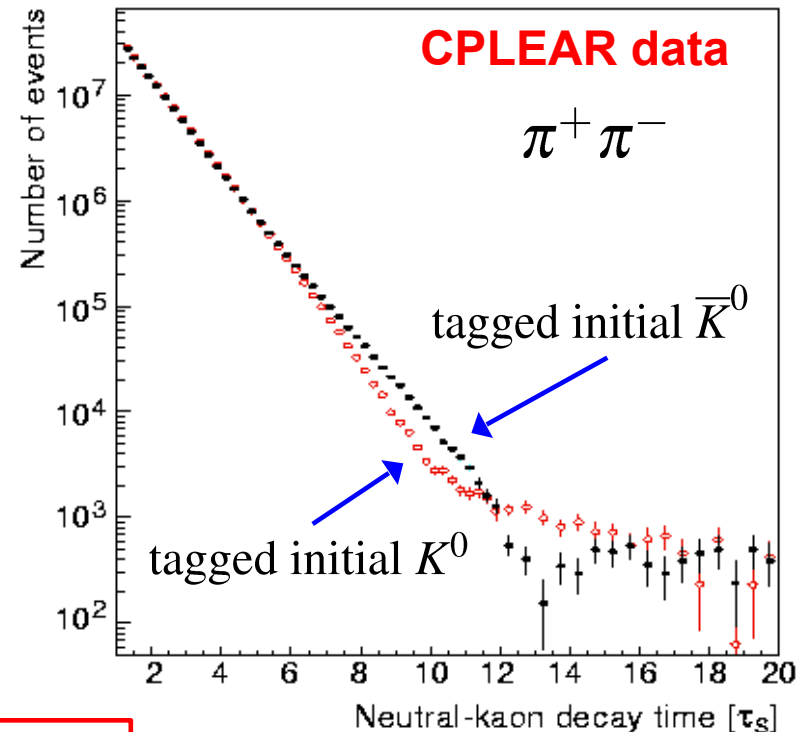
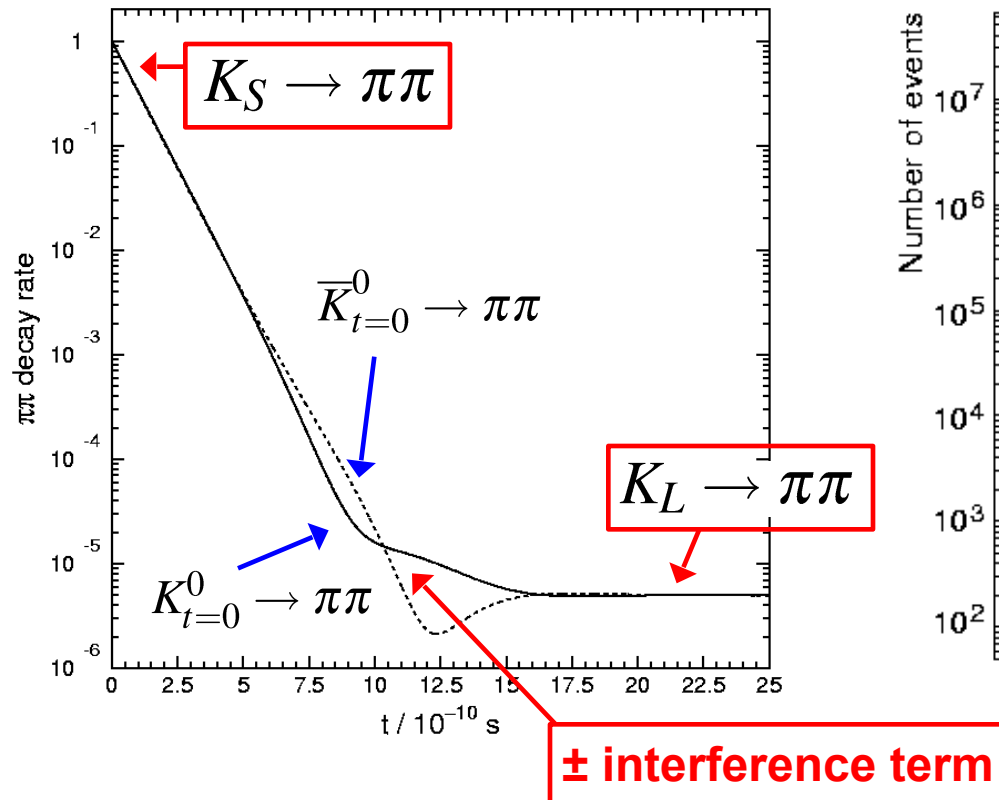

★ The CPLEAR data shown previously can be used to measure  $\varepsilon = |\varepsilon|e^{i\phi}$

• Define the asymmetry:

$$A_{+-} = \frac{\Gamma(\bar{K}_{t=0}^0 \rightarrow \pi\pi) - \Gamma(K_{t=0}^0 \rightarrow \pi\pi)}{\Gamma(\bar{K}_{t=0}^0 \rightarrow \pi\pi) + \Gamma(K_{t=0}^0 \rightarrow \pi\pi)}$$

• Using expressions on page 443

$$A_{+-} = \frac{4\Re\{\varepsilon\} [e^{-\Gamma_S t} + |\varepsilon|^2 e^{-\Gamma_L t}] - 4|\varepsilon| e^{-(\Gamma_L + \Gamma_S)t/2} \cos(\Delta m \cdot t - \phi)}{2[e^{-\Gamma_S t} + |\varepsilon|^2 e^{-\Gamma_L t}] - 8\Re\{\varepsilon\} |\varepsilon| e^{-(\Gamma_L + \Gamma_S)t/2} \cos(\Delta m \cdot t - \phi)}$$

$\propto |\varepsilon| \Re\{\varepsilon\}$  i.e. two small quantities and can safely be neglected

$$\begin{aligned} A_{+-} &\approx \frac{2\Re\{\varepsilon\} [e^{-\Gamma_S t} + |\varepsilon|^2 e^{-\Gamma_L t}] - 2|\varepsilon| e^{-(\Gamma_L + \Gamma_S)t/2} \cos(\Delta m \cdot t - \phi)}{e^{-\Gamma_S t} + |\varepsilon|^2 e^{-\Gamma_L t}} \\ &= 2\Re\{\varepsilon\} - \frac{2|\varepsilon| e^{-(\Gamma_L + \Gamma_S)t/2} \cos(\Delta m \cdot t - \phi)}{e^{-\Gamma_S t} + |\varepsilon|^2 e^{-\Gamma_L t}} \\ &= 2\Re\{\varepsilon\} - \frac{2|\varepsilon| e^{(\Gamma_S - \Gamma_L)t/2} \cos(\Delta m \cdot t - \phi)}{1 + |\varepsilon|^2 e^{(\Gamma_S - \Gamma_L)t}} \end{aligned}$$

A.Apostolakis et al., Eur. Phys. J. C18 (2000) 41

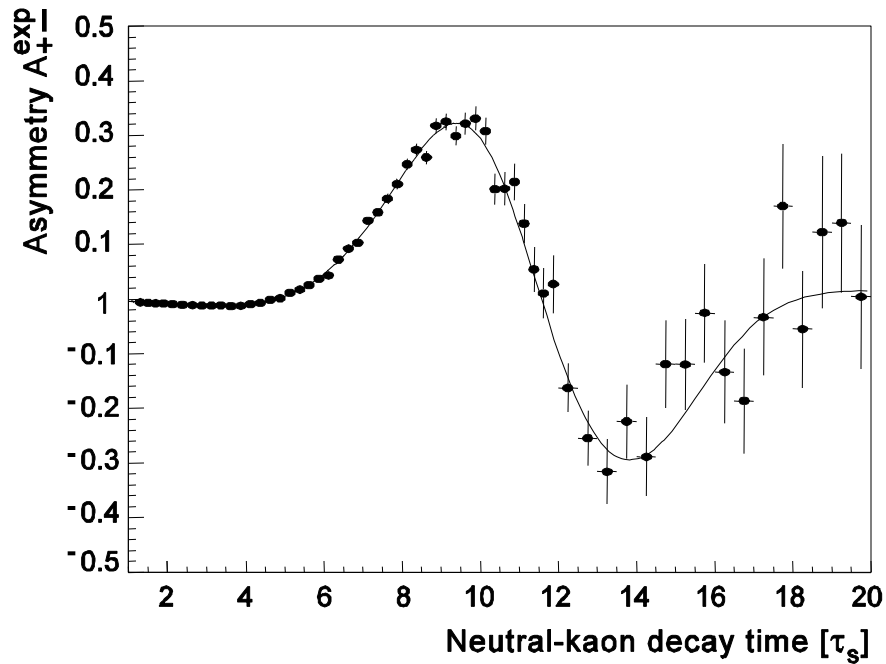

**Best fit to the data:**

$$|\varepsilon| = (2.264 \pm 0.035) \times 10^{-3}$$
$$\phi = (43.19 \pm 0.73)^\circ$$

# Appendix IV: CP Violation via Mixing

Non-examinable

- ★ A full description of the SM origin of CP violation in the kaon system is beyond the level of this course, nevertheless, the relation to the box diagrams is illustrated below
- ★ The K-long and K-short wave-functions depend on  $\eta$

$$|K_L\rangle = \frac{1}{\sqrt{1+|\eta|^2}}(|K^0\rangle + \eta|\bar{K}^0\rangle) \quad |K_S\rangle = \frac{1}{\sqrt{1+|\eta|^2}}(|K^0\rangle - \eta|\bar{K}^0\rangle)$$

with

$$\eta = \sqrt{\frac{M_{12}^* - \frac{1}{2}i\Gamma_{12}^*}{M_{12} - \frac{1}{2}i\Gamma_{12}}}$$

- ★ If  $M_{12}^* = M_{12}$ ;  $\Gamma_{12}^* = \Gamma_{12}$  then the K-long and K-short correspond to the CP eigenstates  $K_1$  and  $K_2$

- CP violation is therefore associated with imaginary off-diagonal mass and decay elements for the neutral kaon system

- Experimentally, CP violation is small and  $\eta \approx 1$

- Define:  $\varepsilon = \frac{1-\eta}{1+\eta} \quad \Rightarrow \quad \eta = \frac{1-\varepsilon}{1+\varepsilon}$

- Consider the mixing term  $M_{12}$  which arises from the sum over all possible intermediate states in the mixing box diagrams

e.g.

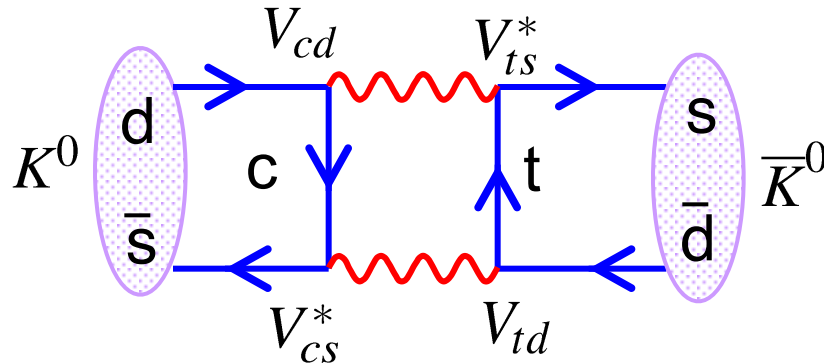

$$M_{12} = A_{ct} V_{cd} V_{cs}^* V_{ts}^* V_{td} + \dots$$

- Therefore it can be seen that, in the Standard Model, CP violation is associated with the imaginary components of the CKM matrix
- It can be shown that mixing leads to CP violation with

$$|\varepsilon| \propto \Im\{M_{12}\}$$

- The differences in masses of the mass eigenstates can be shown to be:

$$\Delta m_K = m_{K_L} - m_{K_S} \approx \sum_{q,q'} \frac{G_F^2}{3\pi^2} f_K^2 m_K |V_{qd} V_{qs}^* V_{q'd} V_{q's}^*| m_q m_{q'}$$

where  $q$  and  $q'$  are the quarks in the loops and  $f_K$  is a constant

• In terms of the small parameter  $\varepsilon$

$$|K_L\rangle = \frac{1}{2\sqrt{1+|\varepsilon|^2}} \left[ (1+\varepsilon)|K^0\rangle + (1-\varepsilon)|\bar{K}^0\rangle \right]$$

$$|K_S\rangle = \frac{1}{2\sqrt{1+|\varepsilon|^2}} \left[ (1-\varepsilon)|K^0\rangle + (1+\varepsilon)|\bar{K}^0\rangle \right]$$

★ If epsilon is non-zero we have CP violation in the neutral kaon system

Writing  $\eta = \sqrt{\frac{M_{12}^* - \frac{1}{2}i\Gamma_{12}^*}{M_{12} - \frac{1}{2}i\Gamma_{12}}} = \sqrt{\frac{z^*}{z}}$  and  $z = ae^{i\phi}$

gives  $\eta = e^{-i\phi}$

★ From which we can find an expression for  $\varepsilon$

$$\varepsilon \cdot \varepsilon^* = \frac{1 - e^{-i\phi}}{1 + e^{-i\phi}} \cdot \frac{1 - e^{+i\phi}}{1 + e^{i\phi}} = \frac{2 - \cos\phi}{2 + \cos\phi} = \tan^2 \frac{\phi}{2}$$

$$|\varepsilon| = \left| \tan \frac{\phi}{2} \right|$$

★ Experimentally we know  $\varepsilon$  is small, hence  $\phi$  is small

$$|\varepsilon| \approx \frac{1}{2}\phi = \frac{1}{2} \arg z \approx \frac{1}{2} \frac{\Im\{M_{12} - \frac{1}{2}i\Gamma_{12}\}}{|M_{12} - \frac{1}{2}i\Gamma_{12}|}$$

# Appendix V: Time Reversal Violation

- Previously, equations (4) and (5), obtained expressions for strangeness oscillations in the absence of CP violation, e.g.

$$\Gamma(K_{t=0}^0 \rightarrow K^0) = \frac{1}{4} \left[ e^{-\Gamma_S t} + e^{-\Gamma_L t} + 2e^{-(\Gamma_S + \Gamma_L)t/2} \cos \Delta m t \right]$$

- This analysis can be extended to include the effects of CP violation to give the following rates (see question 24):

$$\Gamma(K_{t=0}^0 \rightarrow K^0) \propto \frac{1}{4} \left[ e^{-\Gamma_S t} + e^{-\Gamma_L t} + 2e^{-(\Gamma_S + \Gamma_L)t/2} \cos \Delta m t \right]$$

$$\Gamma(\bar{K}_{t=0}^0 \rightarrow \bar{K}^0) \propto \frac{1}{4} \left[ e^{-\Gamma_S t} + e^{-\Gamma_L t} + 2e^{-(\Gamma_S + \Gamma_L)t/2} \cos \Delta m t \right]$$

$$\Gamma(\bar{K}_{t=0}^0 \rightarrow K^0) \propto \frac{1}{4} (1 + 4\Re\{\varepsilon\}) \left[ e^{-\Gamma_S t} + e^{-\Gamma_L t} - 2e^{-(\Gamma_S + \Gamma_L)t/2} \cos \Delta m t \right]$$

$$\Gamma(K_{t=0}^0 \rightarrow \bar{K}^0) \propto \frac{1}{4} (1 - 4\Re\{\varepsilon\}) \left[ e^{-\Gamma_S t} + e^{-\Gamma_L t} - 2e^{-(\Gamma_S + \Gamma_L)t/2} \cos \Delta m t \right]$$

- ★ Including the effects of CP violation find that

$$\Gamma(\bar{K}_{t=0}^0 \rightarrow K^0) \neq \Gamma(K_{t=0}^0 \rightarrow \bar{K}^0)$$

**Violation of time reversal symmetry !**

- ★ No surprise, as CPT is conserved, CP violation implies T violation

# Summary

---

- ★ The weak interactions of quarks are described by the CKM matrix
- ★ Similar structure to the lepton sector, we will introduce the PMNS matrix next time when we discuss neutrino oscillations
- ★ CP violation enters through via a complex phase in the CKM matrix
- ★ A great deal of experimental evidence for CP violation in the weak interactions of quarks
- ★ CP violation is needed to explain matter – anti-matter asymmetry in the Universe
- ★ HOWEVER, CP violation in the SM is not sufficient to explain the matter – anti-matter asymmetry. There is probably another mechanism.