



NRG Modbus TCP User Manual

Operating instructions

Manuale d'istruzioni

Betriebsanleitung

Manuel d'instructions

Manual de instrucciones

Brugervejledning

Table of Contents

1.	Introduction	2
1.1	Foreword	2
1.2	Scope	2
1.3	Disclaimer	2
1.4	Warning notice system	2
1.5	Qualified personnel	2
1.6	Abbreviations and acronyms.....	3
1.7	Other documents	3
1.8	Disposal.....	3
2.	Description	4
2.1	System overview.....	4
2.2	System components.....	4
3.	Installation.....	6
3.1	System configuration	6
3.2	Connection diagram	7
3.3	Load connection diagrams	8
3.4	Auto-addressing	9
3.5	Grounding	10
4.	Modbus TCP Configuration.....	11
4.1	Establishing a Modbus TCP connection	11
4.2	Modbus TCP function codes.....	12
5.	Register Maps	15
5.1	NRGC-MBTCP Register Map	15
5.2	RG..CM..N Register Map	16
6.	Functions.....	21
6.1	Functions overview	21
6.2	Switching modes	21
6.3	Measurements	25
7.	Alarms and Diagnostics	27
7.1	LED indications – NRG Controller.....	27
7.2	LED indications – RG..N	27
7.3	Alarms – NRG Controller.....	28
7.4	Alarms – RG..N	29
8.	Service and Maintenance.....	32
8.1	Internal bus communication check.....	32
8.2	Replacing an RG..N	32
8.3	Using the NRG system without ‘REF’ terminal connection.....	33

1. Introduction

1.1 Foreword

The NRG described hereafter is a sub-system made up of a number of solid state relays intended for the switching of heaters in a machine. The solid state relays in this system are able to communicate with the main controller through an NRG controller that facilitates communication between the solid state relays and the main controller. The NRG controller is available with various communication interfaces including EtherCAT, EtherNet/IP™, Modbus TCP and Modbus RTU. Through this communication, it is possible for the main controller to control each solid state relay, read measurements related to each specific solid state relay and to identify specific failure modes related to the solid state relay or its associated heater load.

1.2 Scope

This manual is intended to provide information about the functionalities that are provided by the NRG system, explains set-up and configuration procedures, provides recommendations for use and gives a troubleshooting guide.

Should there be any problems that cannot be solved with the information provided in this guide, contact your Carlo Gavazzi sales representative for further assistance.

1.3 Disclaimer

Carlo Gavazzi accepts no liability for any consequence resulting from inappropriate, negligent, incorrect installation or adjustment of parameters of the equipment. Nor can Carlo Gavazzi assume liability for recommendations that appear or are implied in the following description. The information in this document is not considered binding on any product warranty.

The contents of this guide are believed to be correct at the time of publishing. In the interests of commitment to a policy of continuous development and improvement, Carlo Gavazzi reserves the right to change the specification of the product or its performance, or the contents of this guide without prior notice.

1.4 Warning notice system

The symbols indicated below are used throughout this guide to indicate a particularly important subject or information on safety instructions, configuration and installation of the products covered by this guide.

It is strongly recommended that this guide is read thoroughly before using the products and that safety related recommendations are followed.



Danger

Indicates that death, severe personal injury, or property damage will result if proper precautions are not taken.



Warning

Indicates actions that if not observed may lead to damage of the products.



Information

Indicates general information related to the proper use of the products.

1.5 Qualified personnel



The product / system described in this documentation may be operated only by personnel qualified for the specific task that are also capable of identifying risks and avoid potential hazards when working with these products.

The NRG system features dangerous voltages and consequently failure to observe the instructions contend in this user manual may cause serious harm to people and damage to property.

1.6 Abbreviations and acronyms

Acronyms	
RG..N / RG..CM..N / End-device	NRG Solid state relays
RGx1A..CM..N	NRG zero cross switching solid state relay
RGx1P..CM..N	NRG proportional switching solid state relay
NRGC..	NRG Controller
COM	Common
PLC	Programmable Logic Controller
SSR	Solid State Relay

1.7 Other documents

Datasheets, installation guide, certificates and other relevant documentation can be found online at www.gavazziautomation.com

1.8 Disposal



Information for users on the correct handling of waste of electrical and electronic equipment (WEEE)

With reference to European Union directive 2002/96/EC issued on 27 January 2003 and the related national legislation, please note that:

- WEEE cannot be disposed of as municipal waste and such waste must be collected and disposed of separately
- the public or private waste collection systems defined by local legislation must be used. In addition, the equipment can be returned to the distributor at the end of its working life when buying new equipment
- the equipment may contain hazardous substances: the improper use or incorrect disposal of such may have negative effects on human health and on the environment
- the symbol (crossed-out wheeled bin) shown on the product or on the packaging and on the instruction sheet indicates that the equipment has been introduced onto the market after 13 August 2005 and that it must be disposed of separately
- in the event of illegal disposal of electrical and electronic waste, the penalties are specified by local waste disposal legislation.

2. Description

2.1 System overview

The NRG is a sub-system that consists of one or more BUS chains that interact with the main controller or PLC in the machine through an EtherCAT communication interface. The communication link in the NRG systems can either be used to control the solid state relay, monitor various parameters, and diagnose faults in real time.

An NRG BUS chain is made up of a minimum 1x NRG controller and a minimum of 1x NRG solid state relay (also referred to as end-device). The NRG bus chain can have a maximum of 32 end devices. The communication link between the NRG controller and the end-devices is the Internal BUS.

When more solid state relays are needed in a system, multiple BUS chains can be utilised. Each BUS chain connects to another BUS chain in a line topology via the NRG controllers of the respective BUS chains or in a star topology via an ethernet switch.

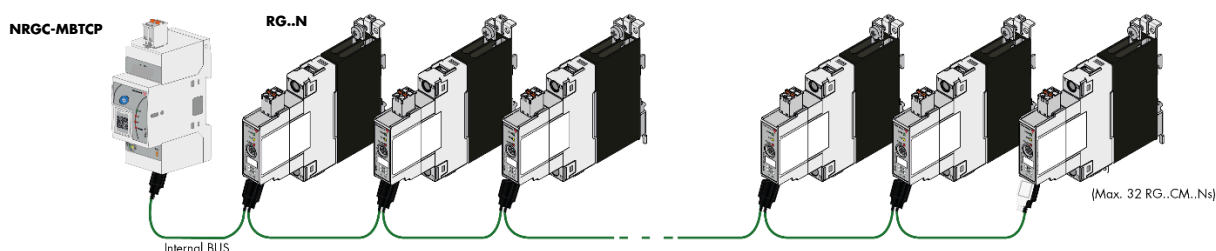

Figure 1: NRG bus chain

2.2 System components

The following system components are required for an NRG bus chain:

Description	Part number	Notes
NRG controller	NRGC..	<p>NRGC NRG Controller with Modbus RTU.</p> <p>NRGC-PN NRG controller with PROFINET.</p> <p>NRGC-EIP NRG controller with Ethernet/IP™.</p> <p>NRGC-ECAT NRG controller with EtherCAT.</p> <p>NRGC-MBTCP NRG controller with Modbus TCP.</p> <p>1x RGN-TERMRES is included in the NRGC.. packaging. The RGN-TERMRES is to be mounted on the last RG..N on the bus chain.</p>
NRG solid state relays	RG..CM..N	<p>RGx1A..CM..N NRG zero cross switching solid state relay</p> <p>RGx1P..CM..N NRG proportional switching solid state relay</p>
NRG Internal bus cables	RGCR-GN-xx	Proprietary cables terminated at both ends with micro USB connector

NRG controller

The NRG controller handles the communication with the higher-level controller and with the NRG solid state relays. It has to be supplied with a 24VDC supply and provides the power supply to the connected NRG solid state relays via the internal bus cables. A termination resistor (RGN-TERMRES) provided with every NRG controller has to be fitted on the last solid state relay of the NRG bus chain. The NRG controller is also capable of performing internal operations to setup and maintain the internal bus.

Various NRG Controller variants are available which facilitate communication via different communication protocols. These are identified via the part numbers. The NRG controller with a Modbus TCP communication interface is the **NRGC-MBTCP**.



NRG solid state relays

The RG..N solid state relays are the switching components in the NRG system. They are available with and without heatsink. For a reference of the variants available refer to the RG..N datasheet. The RG..CM..N utilises the communication system for switching, measurement and diagnostic thus minimising the number of components required in the system. There are 2 variants of the RG..CM..N, the RGx1A..CM..N is the zero cross relay including various switching modes such as ON/OFF, Burst, Distributed full cycle and Advanced full cycle modes. The RGx1P..CM..N is the proportional control variant which on top of the aforementioned switching modes includes also phase angle switching and soft starting features. For more information on the functions of each variant refer to Section 6.



Through the internal BUS, the main controller can read measurement parameters and diagnostics information related to the RG..N and its load. The RG..N is also capable of detecting certain fault conditions. A fault condition is indicated through a red LED available on the façade of the RG..N. The type of fault can be identified through a specific flash rate of the red LED and identified via the communication system.



Since the main controller needs to address each specific RG..N individually, each RG..N needs to be uniquely identifiable. It is not required to physically set the ID for each RG..N. This can be done through an auto-addressing function which occurs automatically on the first start up; whereby each RG..N on the bus chain will automatically be assigned an ID with respect to its physical placement on the internal bus.

NRG internal cables

The RCRGN-xxx-2 is a 5-way proprietary cable used for the internal BUS, i.e., between the NRG controller and the first RG..N on the BUS chain and between respective RG..Ns on the BUS. This internal BUS cable though terminated with a micro-USB plug is not a standard USB cable. Apart from the data and supply lines, the RCRGN-xxx-2 are equipped with an additional wire utilised for the auto-addressing of the RG..Ns on the NRG bus chain. These cables are available in various lengths from Carlo Gavazzi.



For further technical information on each NRG system component please refer to the respective product datasheets:

System component	Datasheet	QR Codes
NRGC-MBTCP	https://gavazziautomation.com/images/PIM/DATASHEET/ENG/SSR_NRGC_MBTCP.pdf	
RG..CM..N	http://gavazziautomation.com/docs/mt_gh/SSR_RG_CM_N.pdf	
RCRGN-xxx-2	http://gavazziautomation.com/docs/mt_gh/SSR_RG_CM_N.pdf	

3. Installation



Installation general requirements

Avoid installing the device in environments with the following characteristics:

- relative humidity higher than 95% or with condensation;
- strong vibrations or shocks;
- exposure to water sprays;
- exposure to aggressive and polluting atmospheres (e.g.: sulphur and ammonia fumes, saline mist, smoke) to avoid corrosion and/or oxidation
- strong magnetic and/or radio frequency interference (thus avoid installation near transmitting antennae)
- exposure of the devices to direct sunlight and the elements in general.

3.1 System configuration

The NRG bus chain consists of 1 NRG controller and up to 32 NRG solid state relays. The NRG controller is the interface to the main controller via the 2xRJ45 shielded communication ports. The connection between the NRG controller and the solid state relays is through the internal bus cables. Each RG..N is equipped with 2x micro USB ports to allow looping between one RG..N and another using the RGCGN-xx-2 bus cables from Carlo Gavazzi. The RGN-TERMRES supplied with each NRG controller has to be connected to the last RG..N on the NRG bus chain.

The NRG controller has to be supplied with a 24VDC via the supply input plug (Us-, Us+). Power to the RG..Ns on the bus chain is provided via the internal bus cables through the NRG controller.

The RG..Ns require a mains reference connection with respect to the load (neutral or another phase) through the 'Ref' connector to provide voltage and power measurements. The Ref connector has 2x internally shorted terminals to allow for looping of the mains reference onto various RG..Ns. Refer to 'Load connection diagrams' section for more information.

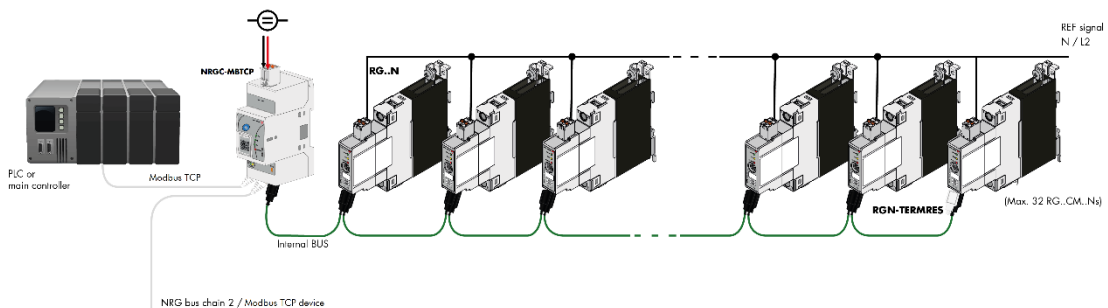

Figure 2 NRG bus chain configuration

3.2 Connection diagram

The NRG bus chain can be connected to the ethernet network via the pair of RJ45 connectors located on the NRG controller. The NRG can be configured in any network topology. If more than 32 solid state relays are required in an application, multiple bus chains can be utilised. These can be configured in a line or star topology as deemed fit for the application.

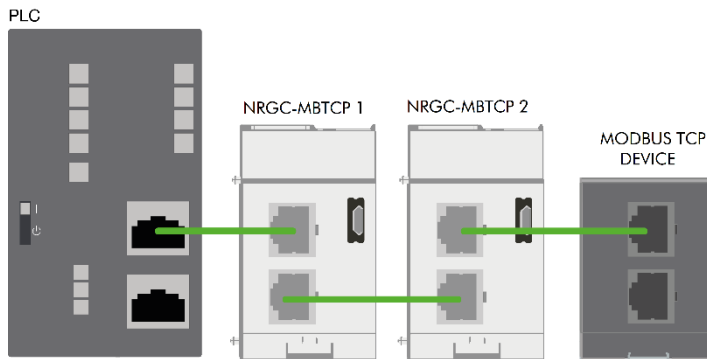

Figure 3 NRG bus chains connected in a line topology

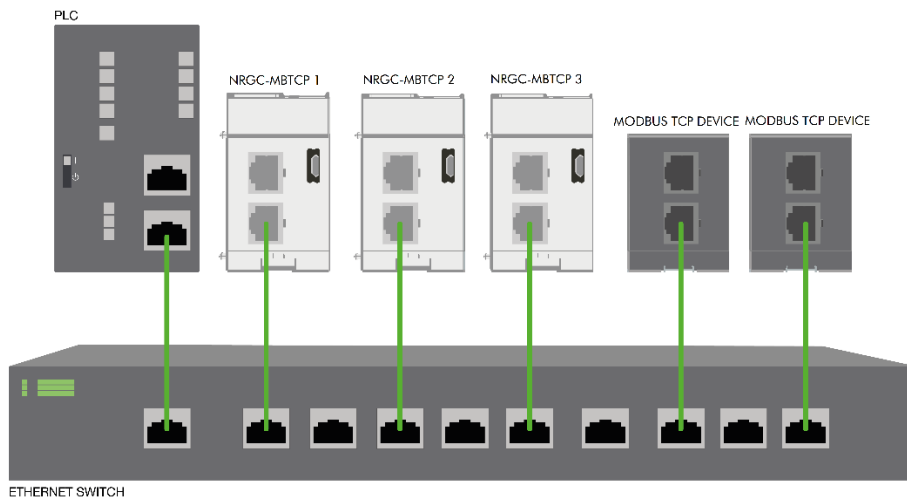

Figure 4 NRG bus chains connected in a star topology

3.3 Load connection diagrams

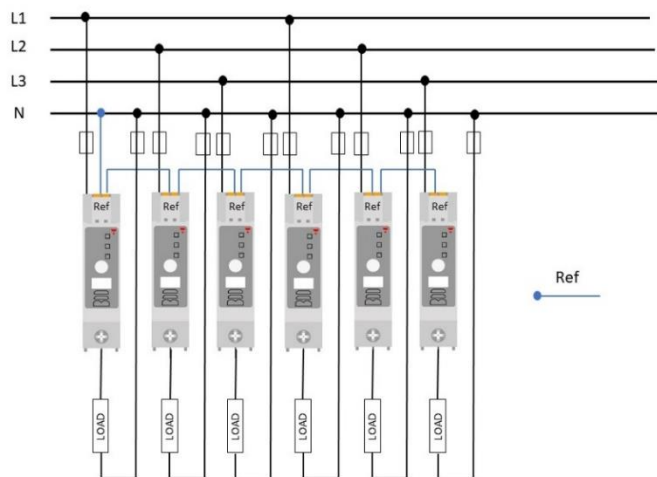

Figure 5 Loads connected between phase and neutral. The Ref connections can be looped from one RG..CM..N to another since all the loads have the same return path

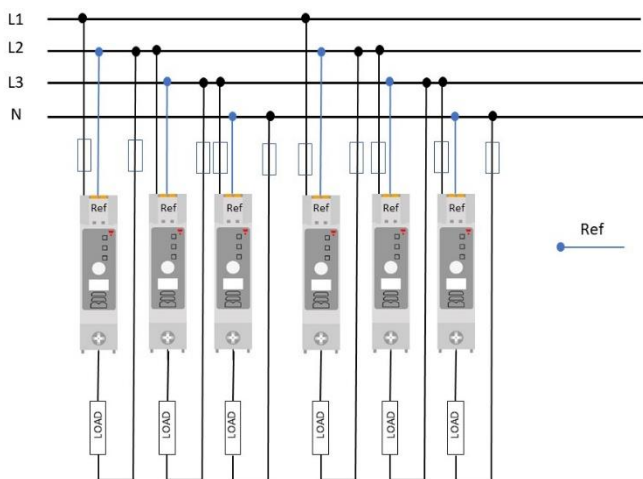

Figure 6 Loads connected between phases. Reference connection (Ref) should always follow the return path of the load

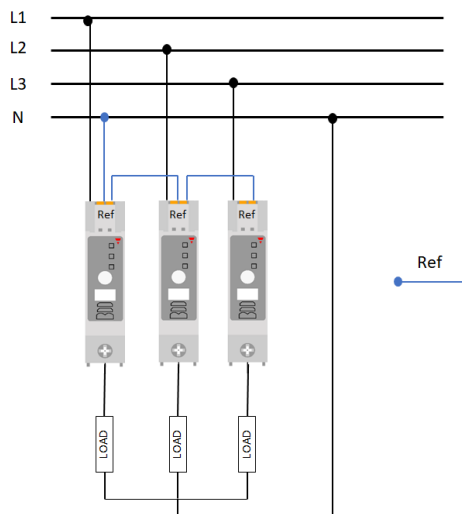

Figure 7 The NRG solid state relay can be utilised with 3-phase loads having a star with neutral configuration. The reference connections (Ref) can be looped from one RG..CM..N to another and

3.4 Auto-addressing

The RG..Ns on the bus chain are automatically addressed upon the initial start-up of the system. The RG..Ns are addressed based on their position on the bus chain.

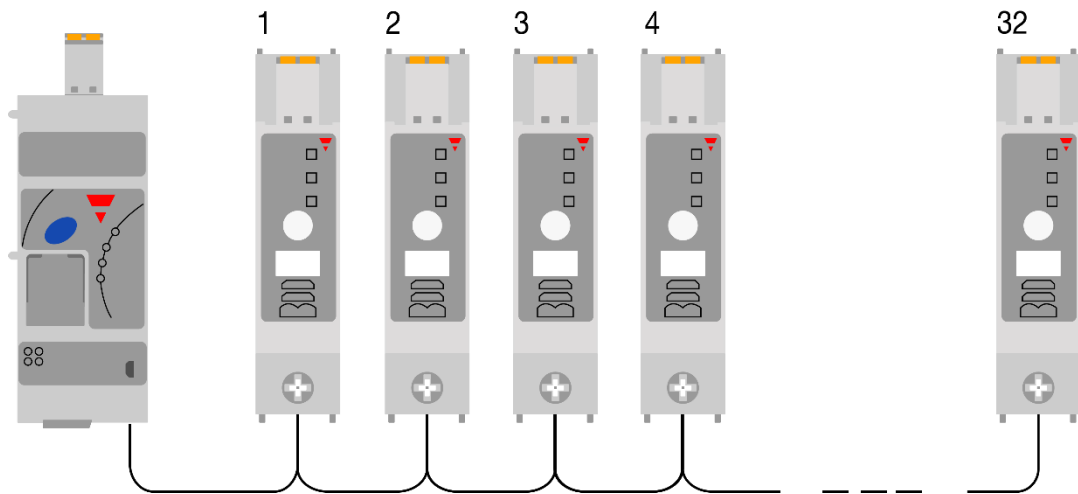

Figure 8 SSRs in NRG bus chain are automatically addressed based on their position on the bus

In case of an RG..N replacement, or any changes to the NRG bus chain, the RG..Ns have to be re-addressed. Follow the procedure below (Figure 9) to re-address the RG..Ns on the NRG bus chain manually. Alternatively, auto-addressing can also be performed digitally, check the NRG-MBTCP Register Map for further information.

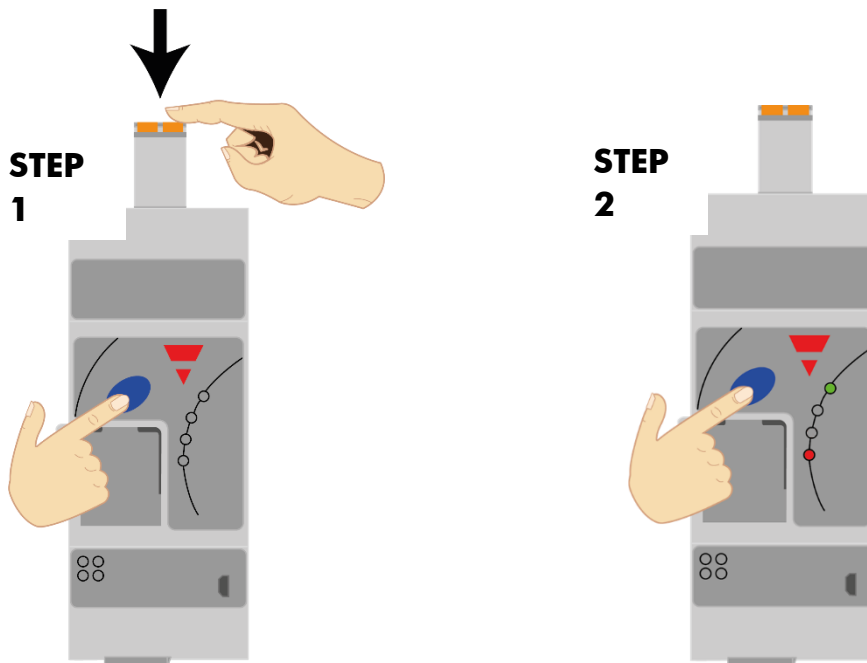

Figure 9 Manual auto-addressing procedure

STEP 1: Hold the blue button while inserting the power supply plug of the NRG-MBTCP

STEP 2: Release the blue button once the Alarm LED turns ON

3.5 Grounding

Connecting the protective ground for the NRG Controller

The NRG controller is equipped with a metal contact clip at the back of the product to provide functional grounding via the Din Rail. The Din Rail must be conductive and grounded. Shielded Cat 5e cables fitted with an outer metallic shell should be used. The shell should be connected to the wire screen of the cable.

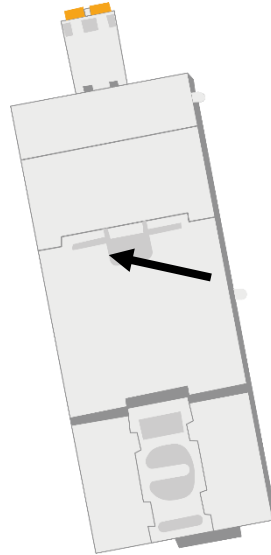

Figure 10 Metal din clip on NRG controller for functional grounding

Connecting the protective earth for the NRG solid state relays

The heatsink of the RGC..Ns has to be earthed via the connection provided using an M5 screw. Note that the M5 Protective Earth (PE) screw is not provided with the RG..N.

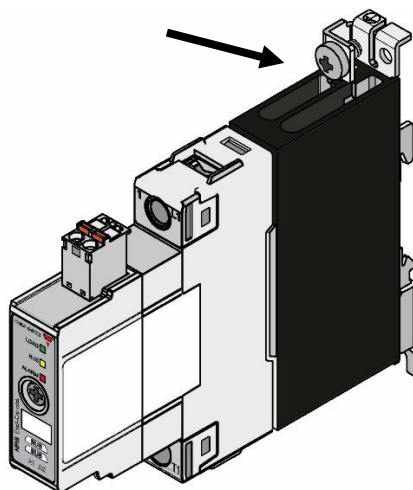

Figure 11 RG..N connection for Protective Earth

4. Modbus TCP Configuration

4.1 Establishing a Modbus TCP connection

To establish a Modbus TCP connection with the NRGC-MBTCP it must be initiated towards the TCP port 502. Figure 12 illustrates the parameters required to establish a connection with the NRGC-MBTCP.

(Target IP address = 192.168.1.5, and TCP port = 502)

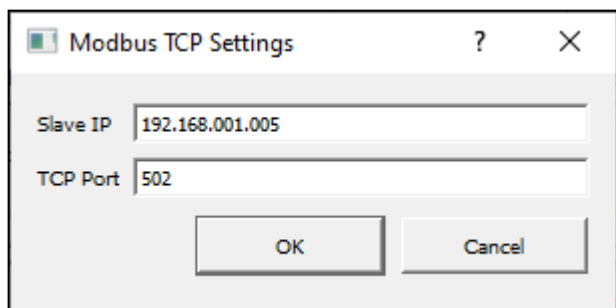

Figure 12 Establishing a Modbus TCP connection

Upon initial start-up or if the Fixed IP Address registers (*check NRGC-MBTCP Register Map*) are not updated (value = 0x0000), the factory default communication settings listed in the following table shall be used to configure the TCP/IP stack.

Default Communication Settings	
IP address	192.168.1.[last byte of the MAC address] The MAC address is in hexadecimal format. Therefore, if for example the MAC address is 68-49-B2-00-00-1F, the IP address configured is 192.168.1.31 As a reference, the default IP address in full is listed on the side label of the NRGC-MBTCP
Subnet netmask	255.255.255.0
Default gateway	192.168.1.254

From the 'IP Address Control Mode' register (*Check NRGC-MBTCP Register Map*), the assignment method of the IP address can be set either to DHCP, BOOTP, Fixed IP address (via the Fixed IP Address registers) or the fall back procedure.

If the IP configuration flag in the 'IP Address Control Mode' register is set to **DHCP** enabled, the TCP/IP stack looks for a DHCP server to start requesting an IP address. If no DHCP server is found (or the assignment of the IP address fails) the TCP/IP stack reports an error.

If the IP configuration flag is set to **BOOTP** enabled in the 'IP Address Control Mode' register, the TCP/IP stack looks for a BOOTP server to start requesting an IP address. If no BOOTP server is found (or the assignment of the IP address fails) the TCP/IP stack reports an error.

If the IP configuration flag is set to **Fall back procedure**, the TCP/IP stack will look for a DHCP server first. If no DHCP server is found, the stack looks for a BOOTP server, and if in turn this is not found as well the stack will try to configure the fixed IP address. If this also fails the TCP/IP stack reports an error.

If the IP configuration flag is set to **Fixed IP address** (default), the TCP/IP stack will try to extract the communication settings from the Fixed IP Address registers, Subnet netmask registers and Default gateway registers. If these registers are set to 0x0000, the factory default communication settings are expected to configure the TCP/IP stack.

Recovery procedure:

In case the NRGC-MBTCP is wrongly configured and is no longer possible to access it, there is a recovery procedure as outlined below:

1. Press the blue button on the façade of the NRGC-MBTCP for more than 10 seconds.
2. Restart the NRGC-MBTCP device.
3. The TCP/IP settings of the device have been changed to the default IP settings and can be used to initiate a TCP/IP connection.

4.2 Modbus TCP function codes

The following is a list of the Modbus Function Codes supported by the NRGC-MBTCP / RG..CM..N:

- Read Holding Registers (0x03)
- Read Input Registers (0x04)
- Write Single Register (0x06)
- Write Multiple Registers (0x10)
- Read Device Identification (0x2B)

As for the Read Device Identification FC, both Basic and Regular device identification access types (either as stream or individual access). The supported Conformity Level is 0x82 – regular identification (stream and individual access).

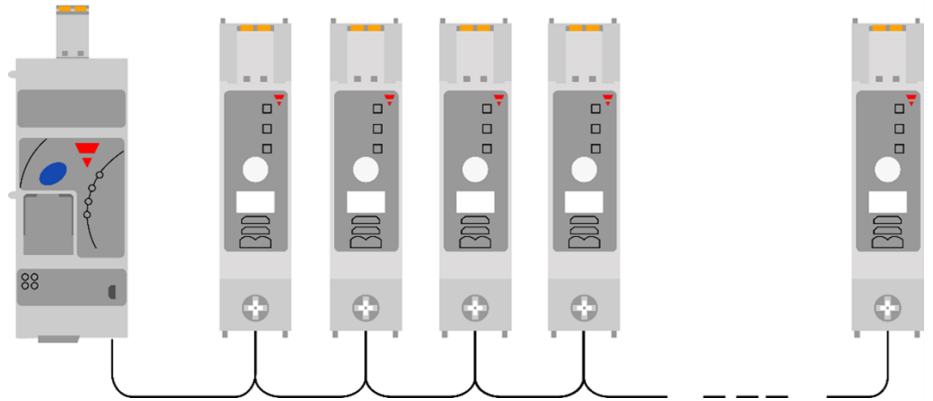

Device ID	255	1	2	3	4	...	32
------------------	------------	----------	----------	----------	----------	------------	-----------

ID 1-32: a maximum of 32 RG..N solid state relays can be connected to 1 NRGC-MBTCP

The Unit ID to be used in the commands, shall correspond to the above indications. The Unit ID of the RG..CM..N is dependent on their position on the bus chain (1,2,3..32) whereas the Unit ID of the NRGC-MBTCP is always 255.

Example messages

Read Holding Registers (0x03)

Request

Field Name	Size	Value
UNIT ID	1 byte	255 (NRGC-MBTCP ID) 1 – 32 (RG..CM..N ID based on their position on the bus chain)
Function Code	1 byte	0x03
Starting Address	2 bytes	Refer to Register Maps (Section 5)
Quantity of Registers	2 bytes	0x0001 to 0x007D (125)

Normal Response

Field Name	Size	Value
UNIT ID	1 byte	255 (NRGC-MBTCP ID) 1 – 32 (RG..CM..N ID based on their position on the bus chain)
Function Code	1 byte	0x03
Byte Count	2 bytes	2xN*
Register Value	N* x 2 bytes	

N* = Quantity of Registers

Exception Response

Field Name	Size	Value
Error Code	1 byte	0x83
Exception Code	1 byte	

Read Input Registers (0x04)

Request

Field Name	Size	Value
UNIT ID	1 byte	255 (NRGC-MBTCP) 1 – 32 (RG..CM..N ID based on their position on the bus chain following auto-addressing)
Function Code	1 byte	0x04
Starting Address	2 bytes	Refer to Register Maps (Section 5)
Quantity of Registers	2 bytes	0x0001 to 0x007D (125)

Normal Response

Field Name	Size	Value
UNIT ID	1 byte	255 (NRGC-MBTCP ID) 1 – 32 (RG..CM..N ID based on their position on the bus chain following auto-addressing)
Function Code	1 byte	0x04
Byte Count	2 bytes	2xN*
Register Value	N* x 2 bytes	

N* = Quantity of Registers

Exception Response

Field Name	Size	Value
Error Code	1 byte	0x84
Exception Code	1 byte	

Write Single Holding Register (0x06)

Request

Field Name	Size	Value
UNIT ID	1 byte	255 (NRGC-MBTCP) 1 – 32 (RG..CM..N ID based on their position on the bus chain following auto-addressing)
Function Code	1 byte	0x06
Register Address	2 bytes	Refer to Register Maps (Section 5)
Register Value	2 bytes	0x000 0xFFFF (depending on register)

Normal Response

Field Name	Size	Value
UNIT ID	1 byte	255 (NRGC-MBTCP ID) 1 – 32 (RG..CM..N ID based on their position on the bus chain following auto-addressing)
Function Code	1 byte	0x06
Register Address	2 bytes	Refer to Register Maps (Section 5)
Register Value	2 bytes	0x000 0xFFFF (depending on register)

Exception Response

Field Name	Size	Value
Error Code	1 byte	0x86
Exception Code	1 byte	

Write Multiple Holding Registers (0x10)

Request

Field Name	Size	Value
UNIT ID	1 byte	255 (NRGC-MBTCP) 1 – 32 (RG..CM..N ID based on their position on the bus chain following auto-addressing)
Function Code	1 byte	0x10
Starting Address	2 bytes	Refer to Register Maps (Section 5)
Quantity of Registers	2 bytes	0x000 to 0x007B (123)
Byte count	1 byte	2x N*
Registers Value	N* x 2 bytes	

N* = Quantity of Registers

Normal Response

Field Name	Size	Value
UNIT ID	1 byte	255 (NRGC-MBTCP ID) 1 – 32 (RG..CM..N ID based on their position on the bus chain following auto-addressing)
Function Code	1 byte	0x10
Starting Address	2 bytes	Refer to Register Maps (Section 5)
Quantity of Registers	2 bytes	0x000 to 0x007B (123)

Exception Response

Field Name	Size	Value
Error Code	1 byte	0x90
Exception Code	1 byte	

5. Register Maps

5.1 NRG-MBTCP Register Map

NRGC-MBTCP Holding Registers

Register Name	Register Add.	Description
Auto-addressing Command/Status	1 0x0001	Writing: 3 -> Trigger an auto-addressing of the NRG bus chain on the next NRG-MBTCP powerup.
Fixed IP Address 1	70 0x0046	Holds the upper two bytes (digits) of the IP address while 'Fixed IP Address 2' holds the lower two bytes (digits) of the same address. For example, if the IP address to be assigned to the NRG-MBTCP is 192.168.1.100, the values of the above mentioned registers will be: Fixed IP Address 1 = 0xC0A8 (0xC0 = 192, 0xA8 = 168) Fixed IP Address 2 = 0x0164 (0x01 = 1, 0x64 = 100) Default -> 0
Fixed IP Address 2	71 0x0047	holds the lower two bytes (digits) of the IP address Default -> 0
Subnet Mask 1	72 0x0048	Holds the upper two bytes (digits) of the subnet mask Default -> 0
Subnet Mask 2	73 0x0049	Holds the lower two bytes (digits) of the subnet mask Default -> 0
Default Gateway 1	74 0x004A	Holds the upper two bytes (digits) of the default gateway to be configured on the NRG-MBTCP Default -> 0
Default Gateway 2	75 0x004B	Holds the lower two bytes (digits) of the default gateway to be configured on the NRG-MBTCP Default -> 0
IP Address Control Mode	76 0x004C	used to configure the assignment method of the IP address. The acceptable values are as follows: 0 (default) -> Fixed IP Address only (either the default factory setting or else the customized IP settings in Fixed IP address registers) 1 -> DHCP only 2 -> BOOTP only 3 -> DHCP, then BOOTP, then fixed IP address (fallback procedure)

NRGC-MBTCP Input Registers

Register Name	Register Add.	Description
NRG Controller Status	256 0x0100	Flag is active if bit = '1' Bit 0 – NRG Controller reset Flag Bit 1 – Not used Bit 2 – Internal error alarm Flag Bit 3 – Not used Bit 4 – Bus error Flag Bit 5 – Device limit error Flag Bit 6 – Device conflict error Flag Bit 7 – Termination error Flag Bit 8 – Device position error Flag Bit 9 – Supply out of range error Flag Bit 10 – Device Unconfigured error Flag Bit 11 – Device Incompatible error Flag Bits 12:15 – Not used (<i>shall be 0</i>)
Last Operation	257 0x0101	Holds the last operation that was requested to the NRG-MBTCP 1 -> Sequence Roll Call (<i>internal</i>) 3 -> Auto-addressing Command 256 -> Communication Check Start 512 -> Communication Check Stop 65280 -> NRG-MBTCP in Blocked State
Total Present Devices	258 0x0102	Total number of RG..Ns present on the bus chain
Correctly Configured Devices	259 0x0103	Total number of devices whose address match their position on the NRG bus chain.
Wrongly Configured Devices	260 0x0104	Total number of devices whose address does not match their position on the NRG bus chain.
Unconfigured Devices	261 0x0105	Total number of devices that do not have an address. An autoconfiguration command is required

5.2 RG..CM..N Register Map

RG...CM..N Holding registers

Register name	Register Add.	Description	Values
Load running hours reset	17 0x0011	Use this index to reset the load running hours reading in case of load or SSR replacement in hours	0 hrs (default) -
RG..N commands	32 0x0020	Insert value to indicate the command that shall be executed by the RG..N	1 -> start a TEACH operation 4 -> store parameters permanently in RG..N 8 -> clear Latched Alarms in case latching of alarms is activated 99 -> factory reset of RG..N
TEACH voltage reference	60 0x003C	Holds the reference voltage to be used for the load deviation alarm. Value is updated automatically with a TEACH command or manually. If TEACH is not successful value will reset to 0	0 (default) – 660VAC

TEACH current reference	61 0x003D	Holds the reference current to be used for the load deviation alarm. Can be updated automatically with a TEACH command or manually If TEACH is not successful value will reset to 0 This parameter is in steps of 0.01, therefore a value of 1745 = 17.45A	0 – Max. current limit (RG..N model dependent)
TEACH % load deviation	62 0x003E	Holds the percentage load deviation used for the load deviation alarm.	4 – 100% 10% (default)
Alarm recovery mode	63 0x003F	Set the alarm recovery mode	0 → Automatic (default) 1 → Manual
Over voltage limit (OVL)	64 0x0040	Set the over and under voltage limit if desired which will trigger an alarm if the voltage reading is beyond the range	0 – 660V & > UVL value Default (660V)
Under voltage limit (UVL)	65 0x0041		0 – 660V & < OVL value Default (0V)
Over current limit (OCL)	66 0x0042	Set the over and under current limit if desired which will trigger an alarm if the current reading is beyond the range This parameter is in steps of 0.01, therefore a value of 1745 = 17.45A	0 – RG..N model dependent & > UCL value Default (RG..N model dependent)
Under current limit (UCL)	67 0x0043		0 – RG..N model dependent & < OCL value Default (0A)
Over frequency limit (OFL)	68 0x0044	Set the over and under current limit if desired which will trigger an alarm if the current reading is beyond the range	44 – 66Hz & > UFL value Default (66Hz)
Under frequency limit (UFL)	69 0x0045		44 – 66Hz & < OFL value Default (44Hz)
Over temperature pre-warning	70 0x0046	Δ temperature from max at which the RG..N will issue an alarm	0 – 50degC Default (0dC)
Soft start ramping time <i>(only for RGx1P..N)</i>	107 0x006B	Activate soft start with time whereby ramping will vary linearly with the set time 0 -> soft start with time is disabled 0.1 – 25.5s -> soft start with time is abled with the set time This parameter is in steps of 0.1, therefore a value of 11 = 1.1s Note: soft start with time and soft start with current limit are mutually exclusive	0 – 255 (0 – 25.5s) Default (0s)
OFF time to soft start <i>(only for RGx1P..N)</i>	108 0x006C	Set the non-firing time before soft start is reactivated. 0 -> soft start with occur on power up only 0.1– 25.5s-> non firing time for soft start to be reactivated This parameter is in steps of 0.1, therefore a value of 11 = 1.1s	0 – 255 (0 – 25.5s) Default 50 (5s)
Soft start current limit <i>(only for RGx1P..N)</i>	109 0x006D	Set the current limit to be utilised with Soft start with current limit mode 0 -> soft start with current limit is disabled 0.1 – RG..N model dependent -> soft start with current limit is enabled with the set current limit. <i>(Recommended 1.2 – 1.5 times the nominal current)</i>	0 – RG..N model dependent Default (0)

		<p>This parameter is in steps of 0.01, therefore a value of 6600 = 66A</p> <p>Note: soft start with time and soft start with current limit are mutually exclusive</p>	
Output substitute mode	110 0x006E	Set the output mode to be used in case of a communication timeout	0 → Clear Output 1 → Hold Output (default) 2 → Set Value
Output substitute value	111 0x006F	Set the % control level to be used in case of a communication timeout. (Only applicable for 'Set Value option' for Output substitute mode)	0 (default) – 100%
Switching mode	112 0x0070	Set the firing mode that the RG..N shall use at the output	0 → External (only for RGx1A..N) 1 → ON/OFF 2 → Burst 3 → Advanced full cycle 4 → Distributed full cycle 5 → Phase Angle (only for RGx1P..N) RGx1A..N default (ON/OFF) RGx1P..N default (Phase Angle)
Time base	113 0x0071	<p>Set the desired time base. (Only applicable for burst firing mode)</p> <p>This parameter is in steps of 0.1, therefore a value of 11 = 1.1s</p>	0.1 (default) - 10s
Voltage compensation <i>(only for RGx1P..N)</i>	114 0x0072	<p>Set the reference voltage used to compensate for deviations in voltage when Voltage Compensation is activated</p> <p>0 -> Voltage compensation is disabled 42 – 600 V – reference voltage for voltage compensation</p>	0, 42 – 600V Default (0)
Control level	130 0x0082	Set the output control level in case of Burst, Advanced Full Cycle and Distributed Full Cycle and Phase Angle switching modes	0 – 100 % Default (0)
ON/OFF 0 Control	140 0x008C	<p>This register will hold the SSR ON/OFF status of a first bank of 16 End-Devices on the NRG bus chain.</p> <p>Bit 0 – Device 1 output status Bit 1 – Device 2 output status Bit 2 – Device 3 output status Bit 3 – Device 4 output status Bit 4 – Device 5 output status Bit 5 – Device 6 output status Bit 6 – Device 7 output status Bit 7 – Device 8 output status Bit 8 – Device 9 output status Bit 9 – Device 10 output status Bit 10 – Device 11 output status Bit 11 – Device 12 output status Bit 12 – Device 13 output status Bit 13 – Device 14 output status Bit 14 – Device 15 output status Bit 15 – Device 16 output status</p> <p>The ON/OFF x Control registers are intended to be written in broadcast mode such that with one message, all devices on one bus chain can be controlled at the same time.</p>	Bit x – 0, 1 0 -> OFF (default) 1 -> ON

		This register is only used when the device firing mode is set to ON/OFF Mode, if the device is in another mode, it will still accept writing to this register, but it will not be used to set device state. Nonetheless if mode is changed to ON/OFF the device will change its state according to the value which had already been written into this register.	
ON/OFF 1 Control	141 0x008D	This register will hold the SSR ON/OFF status of end-devices 17-32 Bit 0 – Device 17 output status Bit 1 – Device 18 output status Bit 2 – Device 19 output status Bit 3 – Device 20 output status Bit 4 – Device 21 output status Bit 5 – Device 22 output status Bit 6 – Device 23 output status Bit 7 – Device 24 output status Bit 8 – Device 25 output status Bit 9 – Device 26 output status Bit 10 – Device 27 output status Bit 11 – Device 28 output status Bit 12 – Device 29 output status Bit 13 – Device 30 output status Bit 14 – Device 31 output status Bit 15 – Device 32 output status	Bit x – 0, 1 0 -> OFF (default) 1 -> ON

RG..CM..N Input Registers

Register name	Register Add.	Description	Values
Control level feedback <i>(only for RGx1P..N)</i> <i>(read only)</i>	5 0x0005	Holds the actual control level of the output firing. (0-100%). In the case of ON/OFF mode it shall give 0 or 100. In the case of the other firing modes, it shall either reflect the control level. If voltage compensation is active than it shall contain the result of the voltage compensation algorithm	0 – 100% 0 (default)
Alarms	6 0X0006	Bit 0 – Mains loss alarm Flag Bit 1 – Load loss/SSR open circuit alarm Flag Bit 2 – RG..N short circuit alarm Flag Bit 3 – Voltage out of range alarm Flag Bit 4 – Current out of range alarm Flag Bit 5 – Frequency out of range alarm Flag Bit 6 – Over-temperature pre warning alarm Flag Bit 7 – Temperature out of range alarm Flag Bit 8 – Load deviation alarm Flag Bit 9 – Soft start current limit reached Flag Bit 10 – Voltage compensation not possible Flag Bits 11:15 - Not used. <i>(shall be 0)</i>	Bit x – 0, 1 0 -> OFF 1 -> ACTIVE
Status	7 0x0007	Bit 0 – Device reset Flag Bit 1 – Autoconfiguration Flag (for internal use) Bit 2 – Internal Error Alarm Flag Bit 3 – Communication Error Flag Bits 4:7 – Not used Bit 8: Alarm Status Flag Bit 9: TEACH busy Flag Bit 10: TEACH successful Flag Bit 11: Ramping Flag Bit 12: Voltage Compensation Active Flag Bits 13:15 - Not used. <i>(shall be 0)</i>	Bit x – 0, 1 0 -> OFF 1 -> ACTIVE
Hold Current Reading	8 0x0008	Holds the average current of the last 16 ON half cycles. Check 'Measurements' section for more info.	0 (default) -

Voltage RMS Reading	9 0x0009	Holds the last reading of the RMS voltage. Check 'Measurements' section for more info.	0 (default) -
Frequency Reading	10 0x000A	Holds the last reading of the frequency. Check 'Measurements' section for more info.	0 (default) -
Current RMS Reading	11 0x000B	Holds the last reading of the RMS current. Check 'Measurements' section for more info.	0 (default) -
Apparent Power Reading	12 0x000C	Holds the apparent power in VA. Check 'Measurements' section for more info.	0 (default) -
Real Power Reading	13 0x000D	Holds the real power reading in W. Check 'Measurements' section for more info.	0 (default) -
Energy Reading (low)	14 0x000E	The energy reading is split into 2 indexes. This index holds the lower value	0 (default) -
Energy Reading (high)	15 0x000F	This index holds the upper value of the energy reading	0 (default) -
SSR ON time	16 0x0010	Holds the accumulated time in hours that the output of the RG..N was switched ON	0 (default) -
Load running hours	17 0x0011	Holds the accumulated ON time of the load. If the load is replaced, value can be reset via the 'Load running hours reset' holding register.	0 hrs (default) -

6. Functions

6.1 Functions overview

The NRG solid state relays are equipped with a range of functionality within one device. For a list of some of the features refer to the table below.

Feature	RGx1A..CM..N	RGx1P..CM..N
External Control	X	-
ON / OFF mode	X	X
Burst Firing mode	X	X
Distributed full cycle Firing mode	X	X
Advanced full cycle Firing mode	X	X
Phase angle Firing mode	-	X
Soft start with time mode	-	X
Soft start with current limit mode	-	X
Voltage compensation	-	X
Monitoring of system parameters	X	X
SSR diagnostics	X	X
Load diagnostics	X	X
Overtemperature protection	X	X

6.2 Switching modes

ON / OFF mode

The ON-OFF mode controls the solid state relays at the user's command. The state of each solid state relay on the bus chain can be controlled via the ON/OFF 0 Control and ON/OFF 1 Control registers. Whereby, each bit represents the state of each solid state relay (ON/OFF).

The advantages of this mode are:

- It is effectively a direct replacement of the A1-A2, i.e. for existing systems, the control algorithm within the PLC can be left relatively untouched and the output is redirected via the communication interface.

All RG..Ns on the bus chain can be controlled within 10ms, given that a Broadcast command is used.

Burst Firing mode

The Burst firing mode works with the control level and a time-base parameter which can be varied from 0.1 seconds to 10 seconds. The percentage ON time is then determined by the control level via an I/O output command. Therefore, with a control level of 10% ;10% of the time-base will be ON and 90% will be OFF. The figure below shows example waveforms of this firing mode at different control levels. In this example the time base was set to 1 second. The percentage control resolution depends on the time base set by the user. To achieve a 1% resolution, the time base has to be a minimum of 2 sec for 50Hz and 1.7 sec for 60Hz.

Output with Burst firing mode @ 33% control level

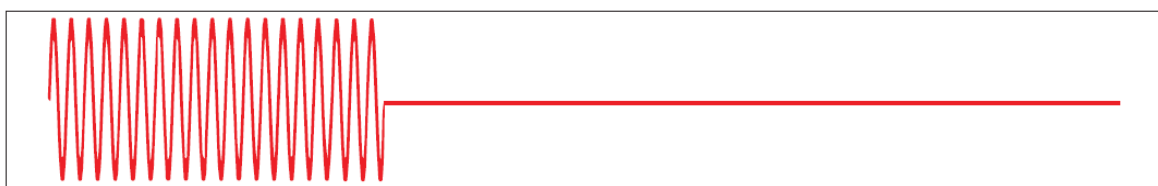

Output with Burst firing mode @ 50% control level

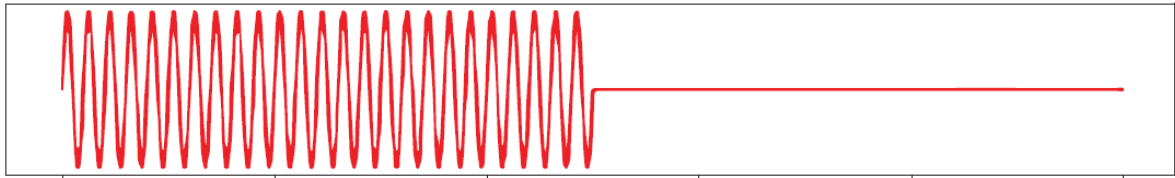

Output with Burst firing mode @ 66% control level

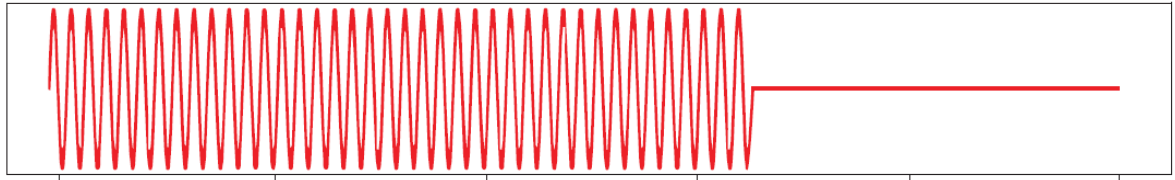

Distributed full cycle Firing mode

The Distributed firing mode works with a control level and a fixed time-base of 100 full cycles (2 seconds for 50 Hz). This mode operates with full cycles, and it distributes the ON cycles as evenly as possible over the time base. In this mode, since the resolution is 1% and the time base is of 100 full cycles, the control level is equal to the number of full cycles over the whole time base.

1% = 1 full cycle every 100 cycles

2% = 2 full cycles every 100 cycles = 1 full cycle every 50 cycles

Output with Distributed firing mode @ 33% control level

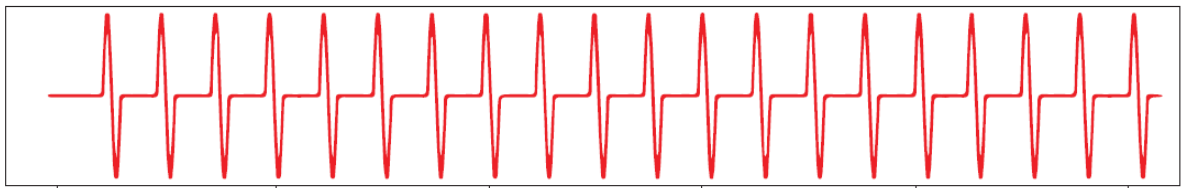

Output with Distributed firing mode @ 50% control level

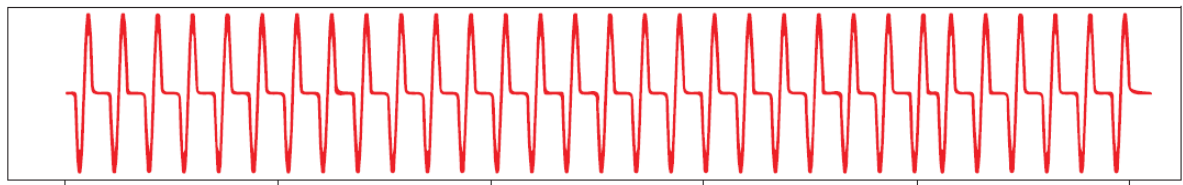

Output with Distributed firing mode @ 66% control level

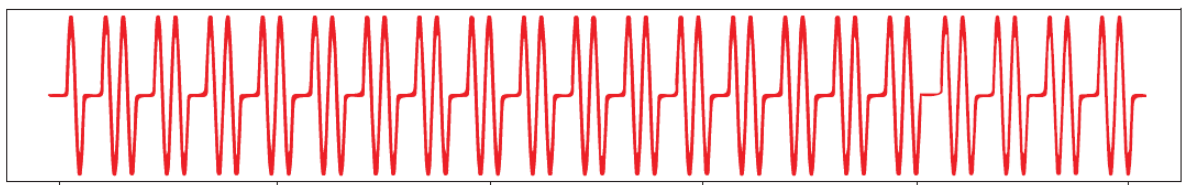

The advantage of Distributed over Burst is the reduction in thermal cycling. On the other hand, Distributed mode suffers from worse harmonics/emissions than Burst mode.

Advanced full cycle Firing mode

Advanced Full Cycle (AFC) firing works on the same concept as Distributed but rather than distributing full cycles, half cycles are distributed. This mode also works over a time base of 100 full cycles (200 half cycles). In this mode, since the resolution is 1% and the time base is of 100 full cycles, the control level is equal to the number of full cycles over the whole time base. 1% = 2 half cycles every 200 half cycles = 1 half cycle every 100 half cycles 2% = 4 half cycles every 200 half cycles = 1 half cycle every 50 half cycles.

Output with Advanced full cycle firing mode @ 33% control level

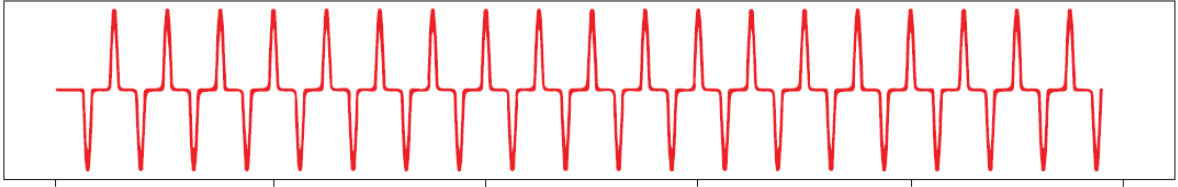

Output with Advanced full cycle firing mode @ 50% control level

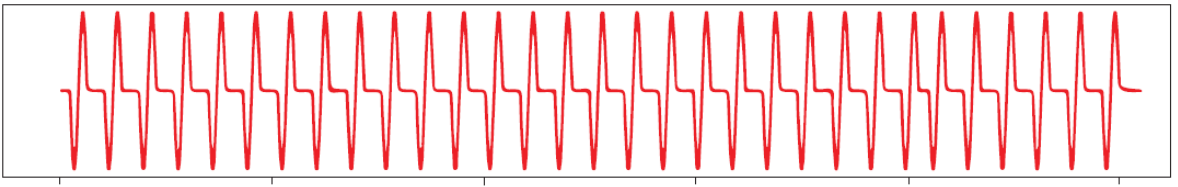

Output with Advanced full cycle firing mode @ 66% control level

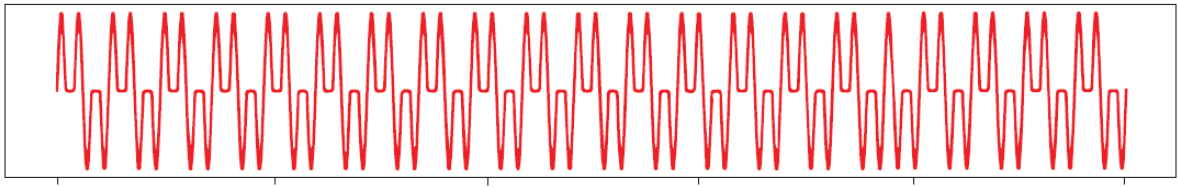

The advantage of AFC over Burst is the reduction in thermal cycling. Another advantage of AFC is that visual flicker is less noticeable than Distributed thus making it suitable for shortwave infrared heater applications. AFC has the disadvantage of worse harmonics/emissions than Burst and also slightly worse than Distributed.

Phase Angle Firing mode

The Phase angle switching mode is available only on the RGx1P.N solid state relays and works in accordance with the phase angle control principle. The power delivered to the load is controlled by the firing of the thyristors over each half mains cycle. The firing angle depends on the control level that determines the output power to be delivered to the load. The power to the load is varied linearly with the control level.

Output with Phase angle firing mode @ 33% control level



Output with Phase angle firing mode @ 50% control level



Output with Phase angle firing mode @ 66% control level

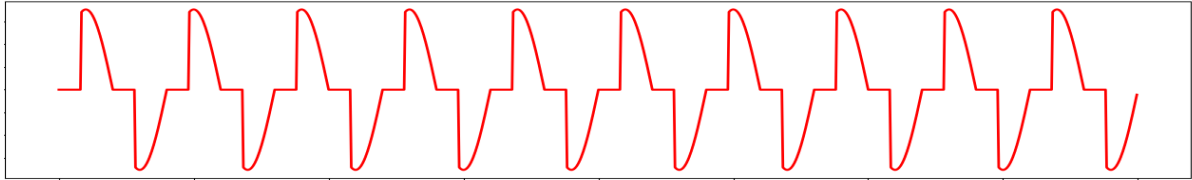

The advantage of Phase angle over the other switching modes is its precise resolution of power. However, Phase angle generates excessive harmonics vs other switching modes. With Phase angle control, the flickering of IR heaters is eliminated completely.

Soft Starting

Soft starting is only available on the RGx1P.N solid state relays. It is utilised to reduce the start-up current of loads having a high cold to hot resistance ratio such as short wave infrared heaters. The thyristor firing angle is gradually increased in order to apply the power to the load smoothly. Soft start can be applied with all the other available switching modes (ON/OFF), Burst, Distributed full cycle, Advanced full cycle and Phase angle. When applied with phase angle, the soft start will stop at the set control level whereas for the other switching mode the soft start will stop until fully ON. Soft start shall be applied upon power up and after a number of non-firing cycles settable by the user (OFF time to soft start setting).

Soft start with Phase angle



Soft start with ON/OFF, Burst, Distributed full cycle and Advanced full cycle firing modes

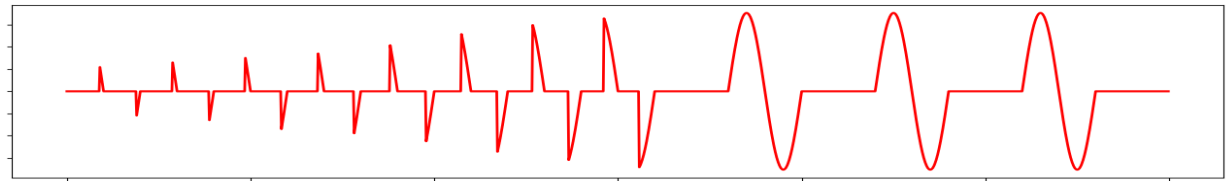

There are two type of soft start modes on the RGx1P..CM..N:

Soft start with time mode

The soft start will apply the power smoothly to the load over a time period of maximum 25.5s. This is settable via the communication system (Soft start ramping time setting).

Soft start with current limit mode

This soft start mode works with a current limit set by the user via the communication. The soft start time will adapt such that the set current limit is not exceeded, and the soft start occurs in the shortest amount for time. The recommended setting for the current limit is 1.2 - 1.5 times the nominal current. The maximum settable current limit is 2 times the rated current of the RG..CM..N variant used. If the current limit is set too low and the current limit is reached, a warning will be notified (Soft start current limit reached).

Voltage compensation

When voltage compensation is utilised, the output power on the output of the solid state relay will remain balanced despite any voltage deviations from normal readings. The algorithm uses a reference voltage set by the user via the communication (Voltage compensation setting) to compute the compensation factor. A new control level is calculated by applying the compensation factor on the control level from the main controller.

The compensation factor (C.F.) applied on the control level is calculated as follows:

$$C.F. = \left(\frac{\text{Reference Voltage}}{\text{Measured Voltage}} \right)^2$$

If the calculated control level after the compensation factor is applied is beyond the control level limits (0 & 100%), the absolute limit will be applied (0 or 100%) and a warning message will be triggered (Voltage compensation not possible).

External Firing mode

The RG..N can also be controlled externally via the A1,A2 terminal behind the blanking cover. For further information on the technical specifications of the input terminal, please refer to the product datasheet. External firing is only available on the RGx1A..CM..N solid state relays.

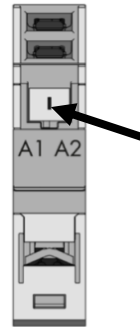

Figure 13 Remove blanking cover from bottom of RG..N to control the RG..N externally. RGM25 plug is required (not included)

Note: For percentage power control switching modes (Burst, Distributed Full cycle, Advance Full cycle and Phase Angle), the response time for each RG..N on the bus chain shall increment by a half mains cycle with each device. Therefore, with 32 devices on the bus chain (max); all RG..Ns are controlled within 250 and 320ms depending on the cycle time.

6.3 Measurements

Voltage RMS

The last reading of the rms voltage is recorded. The value of the reading is in 1V steps hence a value of 50 means 50V, a value of 700 means 700V. If a fault occurs in the system such that it is not possible to measure the voltage, the reading is 0. The reading is updated every half cycle based on the average of the last 16 half cycles. If the Ref terminal is not connected this register reads the on-state voltage of the RG..N when the output is ON.

Current RMS

The last reading of the RMS current is recorded. This reading is in steps of 0.01A hence a value of 50 means 0.5A and a value of 1747 means 17.47A. If a fault occurs in the system such that it is not possible to measure the current, this value is 0. This reading is updated every half cycle but is based on the average of the last 16 half cycles.

Frequency RMS

The last reading of the frequency is recorded. The value is in steps of 1 Hz. If a fault occurs in the system such that it is not possible to measure the frequency, this register gives a value of 0. This value is updated every half cycle but is based on the averaged value of the last 15 cycles.

Hold Current

The average current of the last 16 ON half cycles. This value is in steps of 0.01A hence a value of 50 means 0.5A and a value of 1747 means 17.47A. This measurement can be used as feedback current for an I² control feedback loop.

Apparent Power

The apparent power reading is recorded in VA. This reading is in steps of 1VA and hence a value of 567 would mean 567VA. This value is updated every half cycle and is a multiplication of the Voltage RMS value and Current RMS value determined in the last half cycle. This reading requires the 'Ref' terminal to be connected, otherwise the value will be constantly 0.

Real Power

The real power reading is recorded in W. This reading is in steps of 1W and hence a value of 567 would mean 567W. This value is updated every half cycle and is a multiplication of the Voltage RMS value and Current RMS value determined in the last half cycle. This reading requires the 'Ref' terminal to be connected, otherwise the value will be constantly 0.

Note that for resistive loads with power factor = 1, the real power and the apparent power will be the same.

Energy

The initial value of this register at power-up is the last reading recording before switch OFF of the NRG controller. In case of a new device this value starts from 0. This reading starts counting from the initial value at power-up the kWh consumed during this power up. This reading is updated in steps of 1 kWh hence a value of 1034 would mean 1034kWh.

SSR Running Hours

This reading records the accumulated time in hours that the output of the RG..N was switched ON. The value is updated every half cycle. The initial reading at power-up is the last reading recorded before switch OFF of the NRG controller. In case of a new device this value starts from 0. This reading starts from the initial value at power-up the running hours during this power up. The reading is updated in steps of 1 hour hence a value of 1034 would mean 1034h that the output was ON during its lifetime. In the event that the counter reaches its maximum value, the counter shall roll back to 0 and start counting up again.

Load Running Hours







This reading records the accumulated time in hours that the output of the RG..N was switched ON. The value of this register is updated every half cycle. The initial value of this register at power-up is the last reading recording before switch OFF of the NRG control. This reading is updated in steps of 1 hour hence a value of 1034 would mean 1034h that the output was ON during its lifetime. In case of a new SSR this value starts from 0. This reading can be reset in case of a load or SSR replacement via the Load Running Hours reset setting. A 'Store Permanently' command shall be executed after modifying the value.

7. Alarms and Diagnostics



The NRG bus chain is equipped with on-board diagnostics to facilitate troubleshooting. The status of each component can be identified via the status LEDs on the façade of the product as well as via the communication system.

The errors identified by the NRG controller indicate any identified issues relating to the status of the NRG internal bus. On the other hand, the alarms on the NRG solid state relay indicate any alarms relating to the SSR or the process.

7.1 LED indications – NRG Controller

ON	Green 	ON:	US is present at terminals Us+ Us-
		OFF:	US is not present at terminals Us+ Us-
LINK / ACT	Green 	ON:	The NRG controller is linked to Ethernet
		OFF:	The NRG controller has no link to Ethernet
BUS	Yellow 	ON:	Transmission of messages from NRG Controller to RG..Ns
		OFF:	Internal bus is idle
RUN	Green 	ON:	Connected: OMB task has communication. At least one TCP connection is established
		Flashing (1Hz):	Ready, not configured yet: OMB task is ready and not yet configured
		Flashing (5Hz):	Waiting for communication: OMB task is configured
		OFF:	Not ready: OMB task is not ready
ERR	Red 	ON:	Communication error active
		Flashing:	System error
		OFF:	No communication error
Alarm	Red 	2 Flashes:	Configuration error (Device limit error, Device conflict error, Device unconfigured error, Device position error)
		4 Flash	Supply error
		8 Flashes	Communication error
		9 Flashes	Internal error
		10 Flashes	Termination error

7.2 LED indications – RG..N

LOAD	Green 	ON:	SSR output is ON
		OFF:	SSR output is OFF
BUS	Yellow 	ON:	Communication ongoing between NRG controller and RG..Ns
		OFF:	Communication between NRG controller and RG..Ns is idl
Alarm	Red 	100% ON:	SSR over-temperature
		1 Flash	Load deviation
		2 Flashes	Mains loss
		3 Flashes	Load loss / SSR open circuit
		4 Flashes	SSR short circuit
		5 Flashes	Frequency out of range
		6 Flashes	Current out of range
		7 Flashes	Voltage out of range
		8 Flashes	Communication error (BUS)
9 Flashes	Internal error		

7.3 Alarms – NRG Controller

Internal Error	
Description	This alarm is issued when a problem arises within the internal circuitry of the NRG controller. In the presence of this alarm, the NRG controller will try as much as possible to proceed with normal operation. It is up to the user to detect the presence of errors reported by the NRG and take action accordingly. When continuing operation with NRGs reporting an internal error there is a risk that communication may not work correctly or may not be possible, damage may occur to the RG..N devices on the BUS if the internal error is caused by an overvoltage on the supply lines.
Diagnose	Consider replacing the NRG Controller
Bus Error	
Description	This error is issued in case of wrong messages exchanged between the NRG Controller and the RG..Ns.
Diagnose	Not applicable
Device Limit Error	
Description	More than 32 RG..Ns are detected on the NRG bus chain
Diagnose	Confirm that the number of RG..Ns connected to one NRG Controller is < 32
Termination Error	
Description	This alarm is issued if the NRG controller detects that the BUS between the NRG controller and the RG..Ns is not correctly terminated. This can be due to: <ul style="list-style-type: none"> • An internal fault in the NRG controller (start of BUS termination) • RGN-TERMRES is faulty • An internal fault in the RG..N that affects the BUS This Alarm will clear (unless alarm latching is selected) when the termination of the BUS is found in order.
Diagnose	Make sure RGN-TERMRES is connected to the last RG..N on the NRG bus chain
Device Conflict Error	
Description	Two RG..Ns on the same NRG bus chain have the same address.
Diagnose	Check internal bus connections. If bus connection is correct, do an auto addressing command. Otherwise re-connect the bus as required.
Device Unconfigured Error	
Description	An RG.N on the NRG bus chain does not have an address.
Diagnose	Perform an auto-addressing command
Device Position Error	
Description	The position of some devices on the internal bus does not correspond to the stored address
Diagnose	Check alarms on individual RG..Ns on the internal bus for more detail.
Power supply out of range	
Description	The internal supply voltage of the NRG controller is not within the specified range.
Diagnose	Check that supply on Us+, Us- is within the specified range

7.4 Alarms – RG..N

SSR Overtemperature	
Description	This situation happens when the RG..N does not operate within the rated specifications causing the SSR to overheat. The output of the RG..N is switched OFF to prevent the RG..N from getting damaged due to overheating. When the RG..N cools down, the alarm automatically recovers unless alarm latching is selected, the Alarm LED is switched OFF, and the RG..N output can be switched accordingly
Diagnose	Confirm that RG..N used is operated within the rated specifications (current rating, spacing and surrounding temperature).
SSR Overtemperature Pre-warning	
Description	This is not an alarm condition and has no effect on the function of the RG..N. The Over-Temperature Pre-warning alarm is activated when the pre-warning margin set on the RG..N is not respected. For example, the over temperature prewarning has been set to 40degC and the actual delta is 39degC. In this case, the over temperature prewarning alarm is activated. This alarm is re-set when the actual temperature reading is $\geq 40\text{degC}$. This alarm does not trigger the Alarm LED on the RG..Ns.
Diagnose	Confirm that RG..N used is operated within the rated specifications (current rating, spacing and surrounding temperature).

Load deviation alarm	
Description	<p>This alarm works in conjunction with the TEACH Voltage Reference, TEACH Current Reference and TEACH % load deviation settings. If the values of the TEACH Voltage and Current reference are > 0 either through a 'TEACH' command or updated manually; the load deviation alarm is activated.</p> <p>With a TEACH command the values of Vref and Iref registers will be updated by measuring the present current and voltage over a period of time. The TEACH command is refuted in case of alarms present on the system. If the TEACH is unsuccessful, the values of Vref and Iref will be cleared to 0. The TEACH command does not take control of the output of the SSR, it is up to the user to issue a TEACH command when the output is switched ON with a control percentage of $>5\%$. The duration of the TEACH procedure shall take up to a maximum of 35s depending on the level of control percentage. A 'Store Permanently' command is required after a TEACH command for the values of the Vref and Iref to be saved permanently in the device for next power up.</p> <p>The load deviation alarm is issued when a change in resistance $>$ the % load deviation setting is detected. The resistance is measured using the Voltage and Current reference. The load deviation alarm is useful to detect changes in the load either due to load degradation or partial load failure when more than one load is connected to the SSR.</p>
Diagnose	Check loads for degradation or partial load failure (in case of multiple loads with 1 RGx1A..N). Take into consideration the load thermal coefficient when setting the percentage deviation in LDEVPR to avoid this alarm from being issued unnecessarily.

Mains loss	
Description	Voltage and current signals are missing for more than 3 mains half cycles. The cause is a mains loss (Ref terminal must be connected to identify this alarm otherwise alarm can be either mains loss or load loss)
Diagnose	Ensure mains supply is ON. Confirm that protection (fuses / miniature circuit breakers) have not tripped. Ensure L1 terminal of RG..N is properly connected.

Load loss / SSR Open Circuit	
Description	Load is not switching ON for > a mains half cycle when control signal is present. The cause is either a load loss or a RG..N open circuit condition.
Diagnose	Make sure that load is not faulty or if the SSR is in an open circuit condition. If an RG..N is replaced, make sure to follow the re-addressing procedure.

SSR Short Circuit	
Description	This condition is identified when current >300mA flows through the RG..N output when control signal is OFF.
Diagnose	Make sure that the appropriate short circuit protection is utilised. If an RG..N is replaced, follow readdressing procedure at power-up. Check load and protection devices (fuses or Miniature Circuit Breakers) status before re-starting.

Frequency out of range	
Description	This condition is identified when the frequency measured by the RG..N is not within the set range hence is > Over Frequency value or < Under Frequency value. This alarm is issued if this condition is present for >10 seconds. Though indicated as an alarm condition, this alarm has no effect on the function on the RG..N and it is up to the user to decide what to do when this alarm is activated.
Diagnose	Check line frequency and ensure that the over and under frequency limits are set properly. Though the switching function of the RG..N is not affected by this alarm, care must be taken to make sure RG..N is operated within its rated specification.

Current out of range																	
Description	<p>This condition is identified when the current measured by the RG..N is not within the set range hence is > Over Current value or < Under Current value. This alarm is issued if this condition is present for >10 seconds. Though indicated as an alarm condition, this alarm has no effect on the function on the RG..N and it is up to the user to decide what to do when this alarm is activated.</p> <p>The over current limit is bounded by the maximum current for each NRG solid state relay variant. A list of the variants with their maximum current values is listed in the table below.</p>																
Current limits	<table border="1"> <tbody> <tr> <td>RGC1A60CM25KEN</td> <td>33</td> </tr> <tr> <td>RGC1A60CM32KEN</td> <td>33</td> </tr> <tr> <td>RGC1A60CM32GEN</td> <td>47</td> </tr> <tr> <td>RGC1A60CM42GEN</td> <td>64</td> </tr> <tr> <td>RGC1A60CM62GEN</td> <td>93</td> </tr> <tr> <td>RGS1A60CM50KEN</td> <td>55</td> </tr> <tr> <td>RGS1A60CM92KEN</td> <td>99</td> </tr> <tr> <td>RGS1A60CM92GEN</td> <td>99</td> </tr> </tbody> </table>	RGC1A60CM25KEN	33	RGC1A60CM32KEN	33	RGC1A60CM32GEN	47	RGC1A60CM42GEN	64	RGC1A60CM62GEN	93	RGS1A60CM50KEN	55	RGS1A60CM92KEN	99	RGS1A60CM92GEN	99
RGC1A60CM25KEN	33																
RGC1A60CM32KEN	33																
RGC1A60CM32GEN	47																
RGC1A60CM42GEN	64																
RGC1A60CM62GEN	93																
RGS1A60CM50KEN	55																
RGS1A60CM92KEN	99																
RGS1A60CM92GEN	99																
Diagnose	The over current limit is bounded by the maximum current for each NRG solid state relay variant. A list of the variants with their maximum current values is listed in the table above.																

Voltage out of range	
Description	This condition is identified when the voltage measured by the RG..N is not within the set range hence is > Over Voltage value or < Under Voltage value. This alarm is issued if this condition is present for >10 seconds. Though indicated as an alarm condition, this alarm has no effect on the function on the RG..N and it is up to the user to decide what to do when this alarm is activated.
Diagnose	Check mains and ensure that the over and under voltage limits are set properly. Though the switching function of the RG..N is not affected by this alarm, care must be taken to make sure RG..N is operated within its rated specification.

Communication (BUS) error	
Description	This alarm indicates that there is a communication problem between the NRG-C-MBTCP and the RG..N. It is only issued via the Alarm LED on the RG..N. This alarm should also trigger the BUS error alarm via the communication system.
Diagnose	Not applicable

Internal error	
Description	This alarm is issued when a problem arises within the internal circuit of the RG..N. In the presence of this alarm, the RG..N will try as much as possible to proceed with normal operation. It is up to the user to detect the presence of errors reported by the RG..N and take action accordingly. When continuing operation with RG..Ns reporting an internal error there is a risk that the messages are not correctly received by the RG..N and/or replies will not be correctly received by the NRG.. and/or main controller.
Diagnose	Confirm presence of 24V supply voltage on the NRG Controller US terminals. Otherwise, replace the RG..N reporting an internal error.

Soft start current limit reached (only available for RGx1P..N)	
Description	The set current limit was reached during soft start
Diagnose	The set current limit may be too low for the nominal current. The recommended current limit value is 1.2 – 1.5 times the nominal current

Voltage compensation not possible (only available for RGx1P..N)	
Description	Mains voltage has deviated too much such that the control level after the correction factor has been applied is beyond the control limits (either < 0% or > 100%)
Diagnose	Not applicable

8. Service and Maintenance

8.1 Internal bus communication check

During the initially installation of the system, it may be useful to do a communications check before connecting the NRG controller to the PLC. A communications check will ensure that all RG..Ns connected on the bus chain are responding.

To perform a communications check, press the blue button on the facade of the NRG controller for 2 – 5 seconds. The NRG controller will ping each device sequentially. All communicating RG..Ns on the NRG bus chain will have their BUS LED flashing to indicate that communication was established.

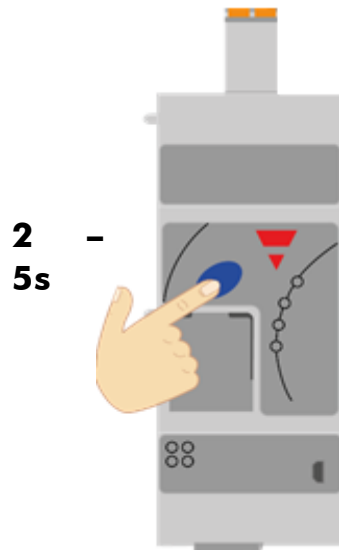

Figure 14 Press blue button for 2 - 5s to start / stop communications check

After finishing with the communications check it is important to turn it off by pressing again the blue button (2-5 secs) otherwise PLC cannot communicate with the NRG bus chain.

8.2 Replacing an RG..N

When an RG..N has to be replaced:

- 1) Connect the new RG..N to the bus chain
- 2) Perform an auto-addressing function as explained in Section 3.3 or via an acyclic command

Note: RG..N replacements should be performed with the system turned OFF.

8.3 Using the NRG system without 'REF' terminal connection

The NRG system can be utilised without connecting the 'REF' terminal however this will constitute some limitations as listed below:

- 1) The following readings are not available: RMS Voltage, Real Power and Apparent Power
- 2) The 'TEACH' operation cannot be executed
- 3) Voltage out of range and Load deviation alarms are not available
- 4) The mains loss alarm cannot be discriminated from a load loss. Therefore, a mains loss alarm will indicate either a mains loss or a load loss.