

Faraday's Law of Electromagnetic Induction

1. If the flux linking a loop (or turn) varies as a function of time, a voltage is induced between its terminals.
2. The value of the induced voltage is proportional to the rate of change of flux

$$E = -N \frac{d\phi}{dt}$$

The “-” sign indicates that the induced E has a tendency to decrease the change of flux

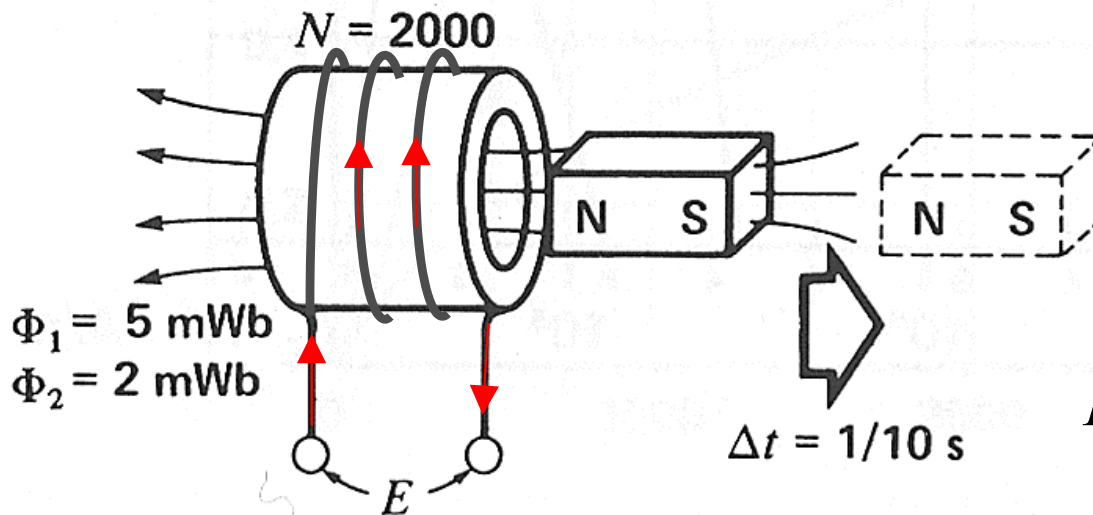

$$E = -2000 \times \frac{0.002 - 0.005}{0.1}$$
$$= 60 \text{ V}$$

Voltage Induced in a Conductor

- Conclusion from Faraday's Law
 - Whenever a moving conductor (part of a coil) cuts a magnetic field B , voltage E is induced across its terminals, which is proportional to its active length l and relative speed v .

$$|E| = \left| -\frac{d\phi}{dt} \right| = \left| \frac{d(BA)}{dt} \right| = \left| \frac{BdA}{dt} \right| = \left| \frac{Blvdt}{dt} \right| = Blv$$

- The direction of current I to be induced in the conductor follows the **right-hand rule**.
- We may simply use formula $E = Blv$ to first calculate the magnitude of E , B or v from any two of them and then judge the direction by the **right-hand rule**.

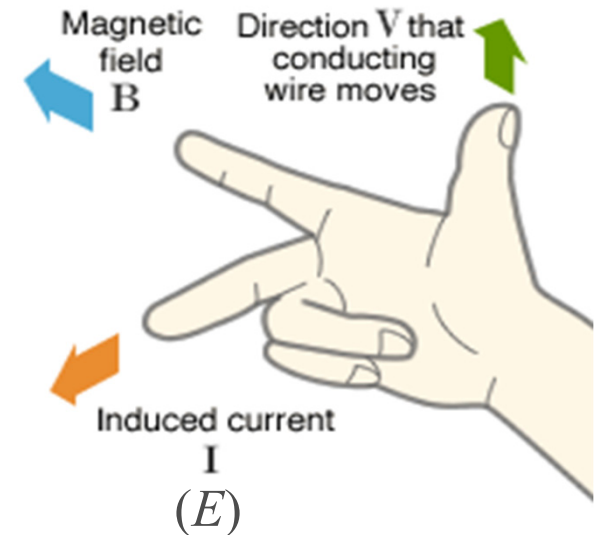
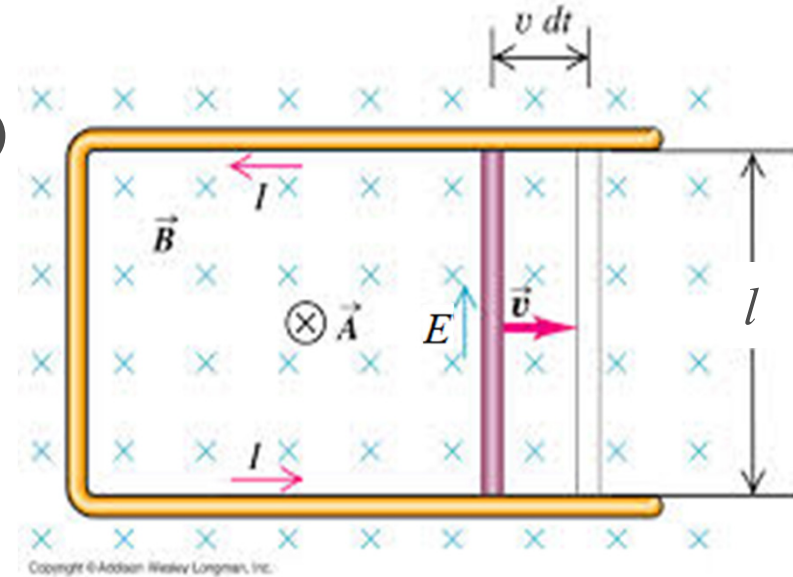

Example 3

- $B=0.6\text{T}$, $l=2\text{m}$, $v=100\text{m/s}$.

$$E = Blv = 0.6 \times 2 \times 100 = 120 \text{ V}$$

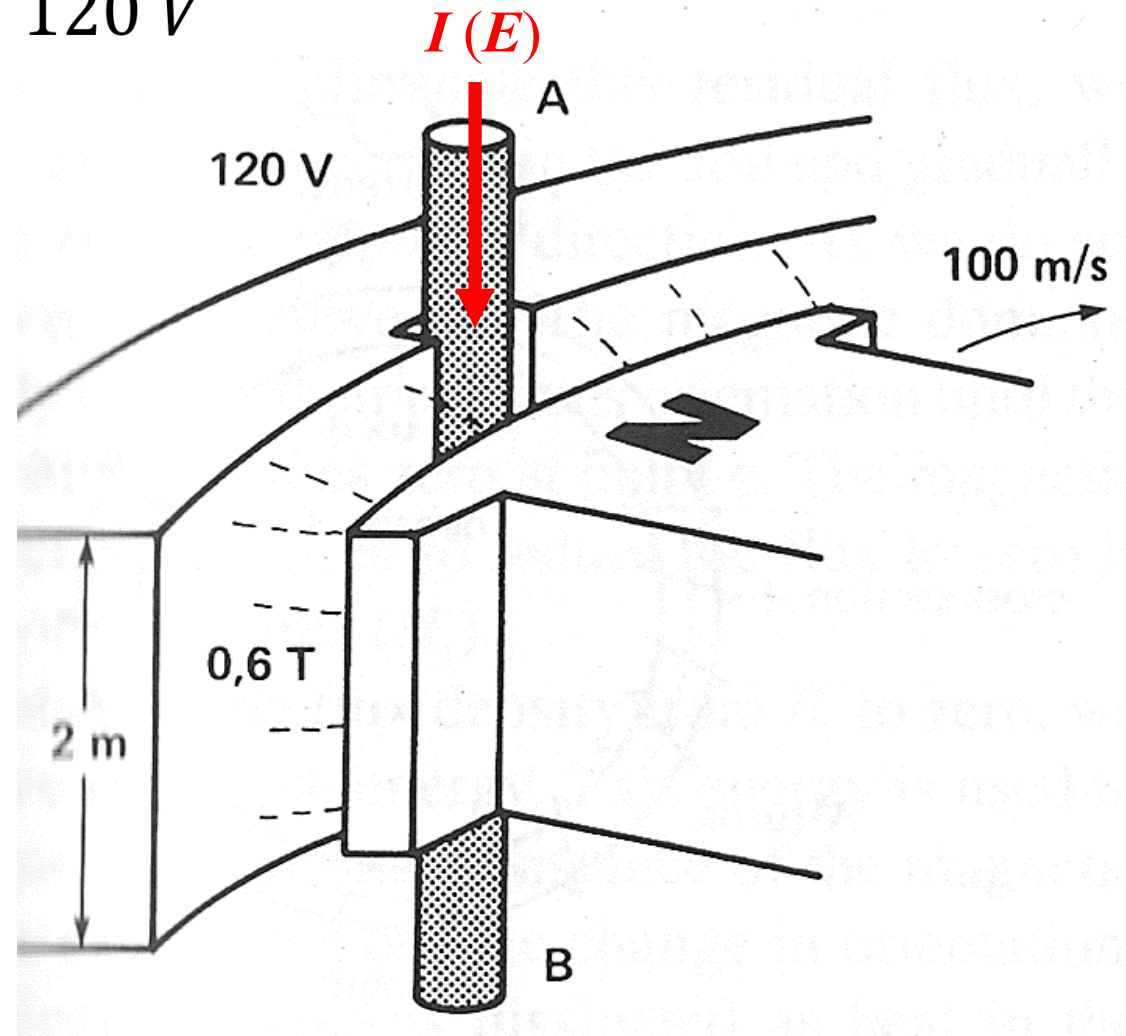

Lorentz Force on a Conductor

- Also called electromagnetic force, it is the force a current-carrying conductor is subjected to when it is placed in a magnetic field.

$$F = B l I \quad (\text{unit: N})$$

- The direction of the Lorentz force follows the **left-hand rule**

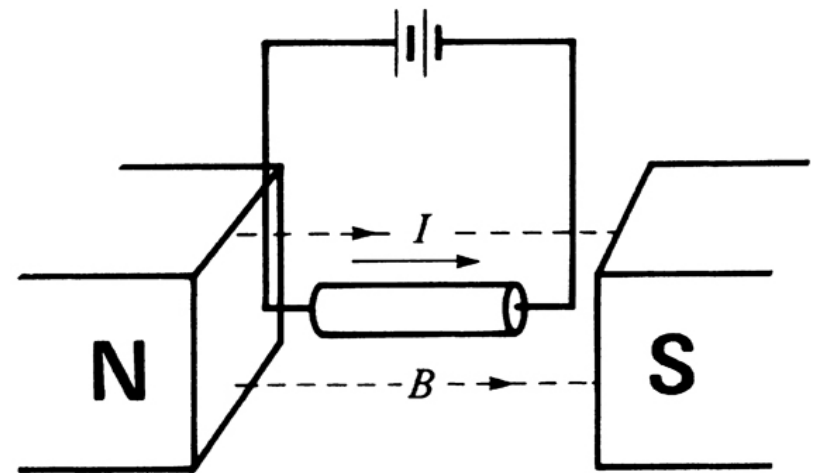
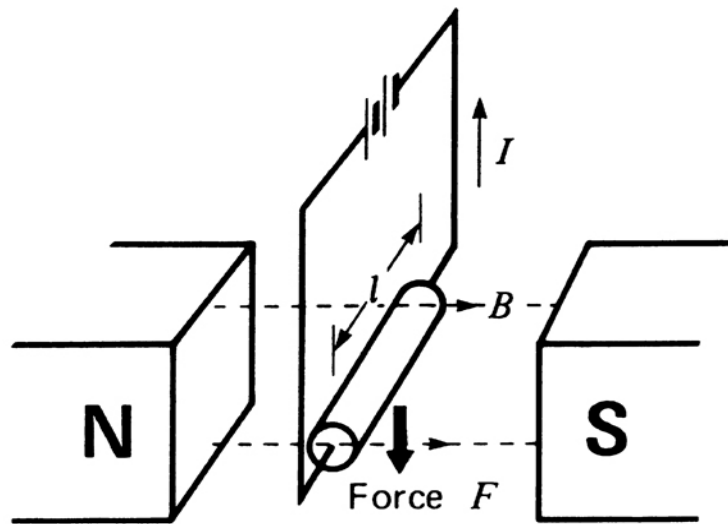
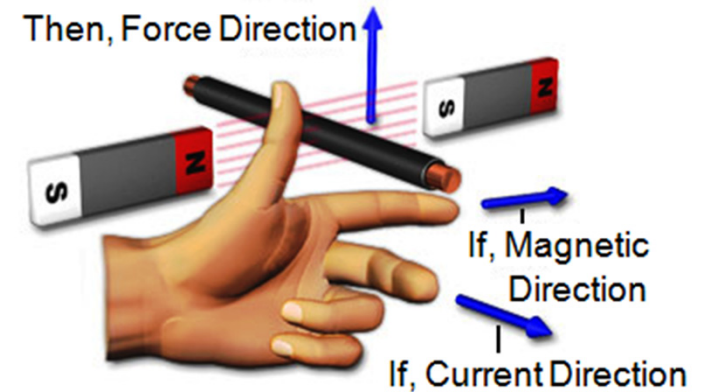

Hysteresis Losses

Hysteresis loop

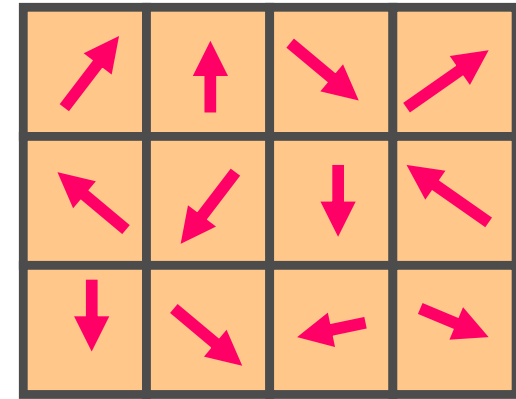
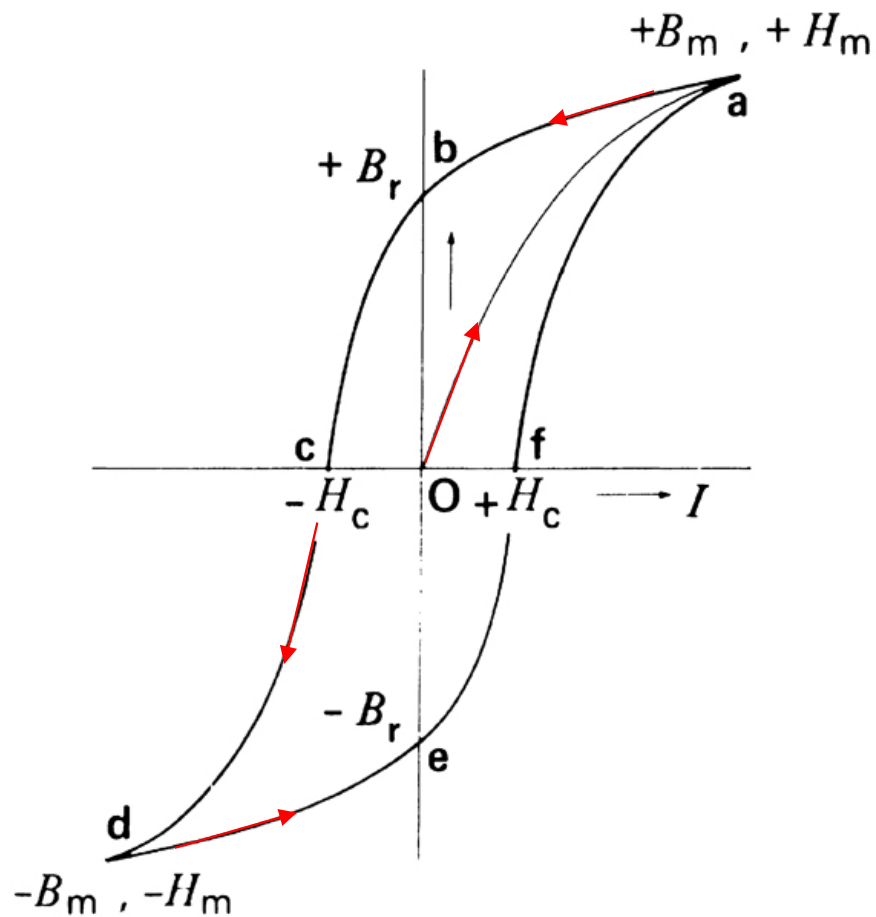

Magnetic domains oriented randomly

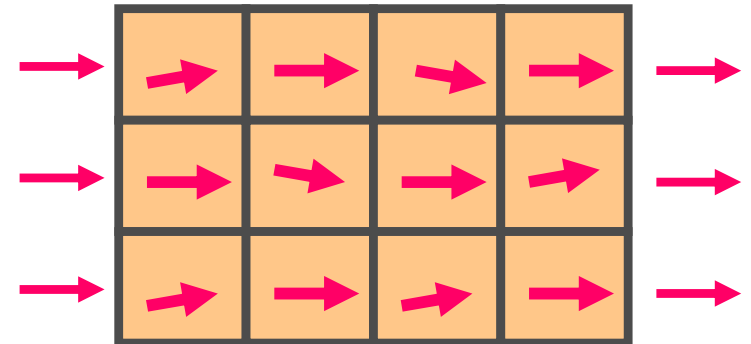

Magnetic domains lined up in the presence of an external magnetic field.

Eddy losses

- The cause of eddy currents by an AC flux Φ

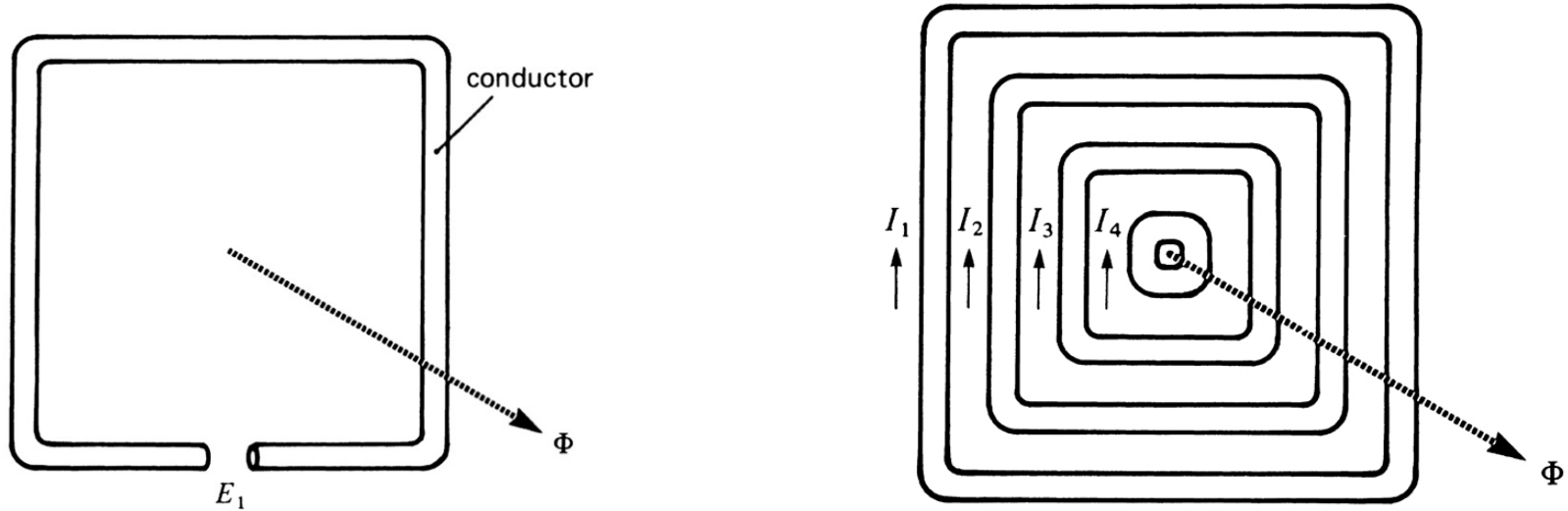

- How to reduce eddy currents

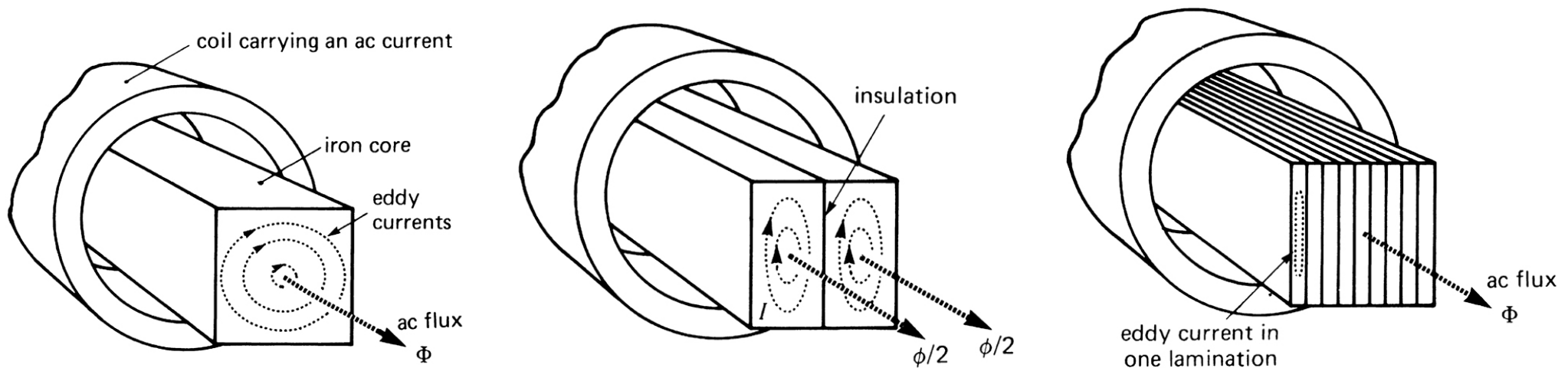

Comparison of Electrical and Magnetic Circuits

Magnetic circuit

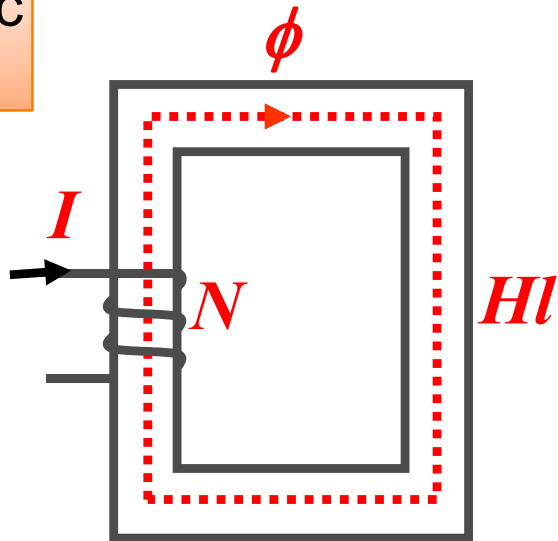

mmf

$$F_m = N \times I$$

Magnetic flux

ϕ

Magnetic potential

$$H \times l$$

Electrical circuit

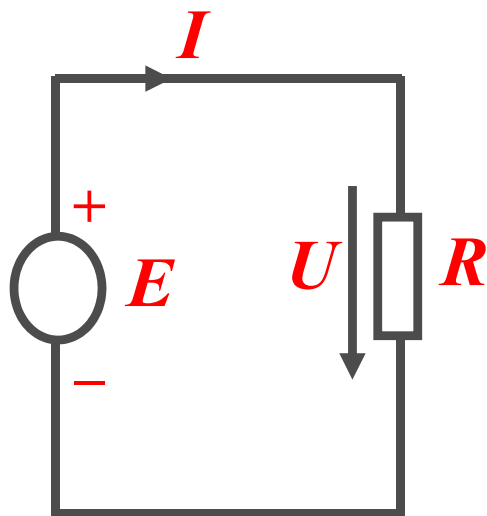

emf

E

Current

I

Electric potential

U

Comparison of Electrical and Magnetic Circuits

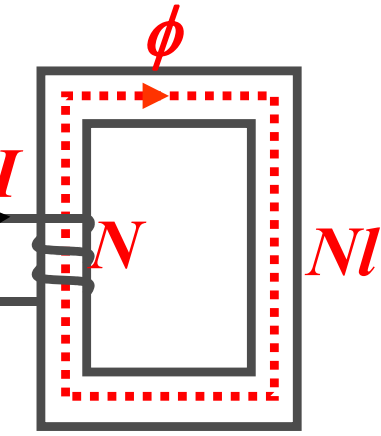
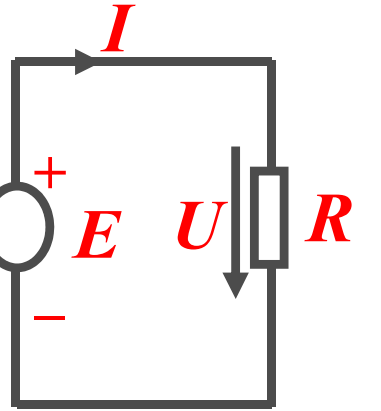
<p>Magnetic circuit</p> 	<p>Hopkinson's Law</p> $\phi = \frac{F_m}{R_m}$	<p>Magnetic resistance</p> $R_m = \frac{l}{\mu_r \mu_0 A}$	<p>Magnetic flux density</p> $B = \frac{\phi}{A}$	<p>Ampere's Circuital Law</p> $\sum NI = \sum Hl$	<p>Gauss's Law</p> $\sum \phi = 0$
<p>Electrical circuit</p> 	<p>Ohm's Law</p> $I = \frac{E}{R}$	<p>Electrical resistance</p> $R = \rho \frac{l}{A}$	<p>Current density</p> $J = \frac{I}{A}$	<p>KVL</p> $\sum E = \sum U$	<p>KCL</p> $\sum I = 0$