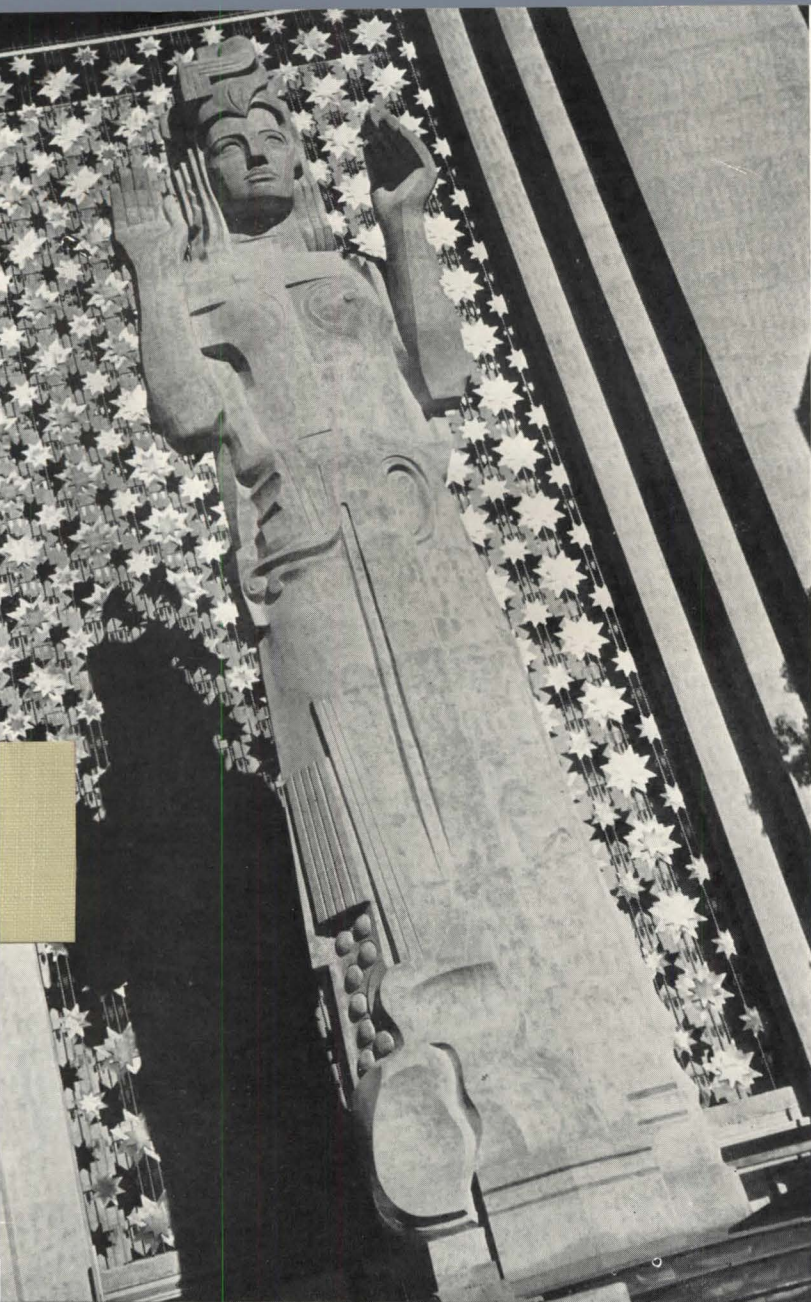


BUILDING NEWS

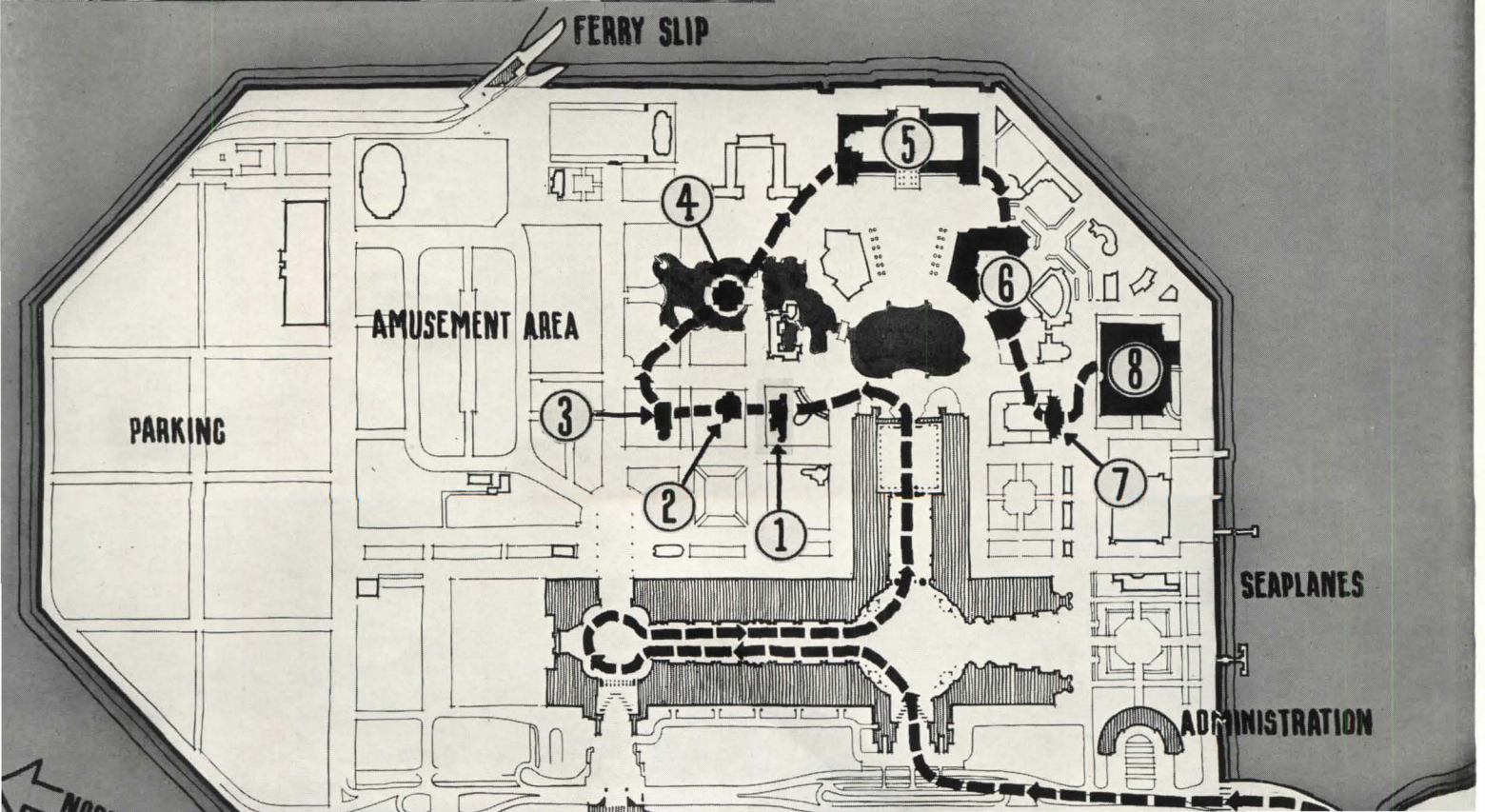




GOLDEN GATE

Celebrating the completion of two of the longest bridges in the world, the recently opened Golden Gate International Exposition at San Francisco is itself an engineering feat of no small dimensions. But so, for that matter, are most international fairs, past and present; in fact, the fair becomes increasingly the most important medium for introducing new building design principles, equipments, and materials. From the standpoint of the average designer, therefore, the most valuable survey will be not of those factors which are common to all fairs, but rather those which are characteristic of a particular project. This, **ARCHITECTURAL RECORD** has attempted to do, selecting some of those structures which—because of certain aspects of plan, construction, and/or equipment—indicate rising levels of building design, improved performance.

All photographs, except where noted, were taken specially for **ARCHITECTURAL RECORD** by Jean St. Thomas. Sketches are by the illustrator, Chichi Lasley.



INTERNATIONAL EXPOSITION 1939



KEY TO EXPOSITION PLAN

1. United States of Brazil Pavilion. 45
2. Republic of Argentina Pavilion. 46
3. Republic of France Pavilion. 48
4. Pacific House 49
5. U. S. Government Building. 51
6. California Group 54
 Court of Seals 55
 State of California Building. 56
 San Francisco Building. 57
7. Hall of Floriculture. 58
8. Fine and Decorative Arts. 60

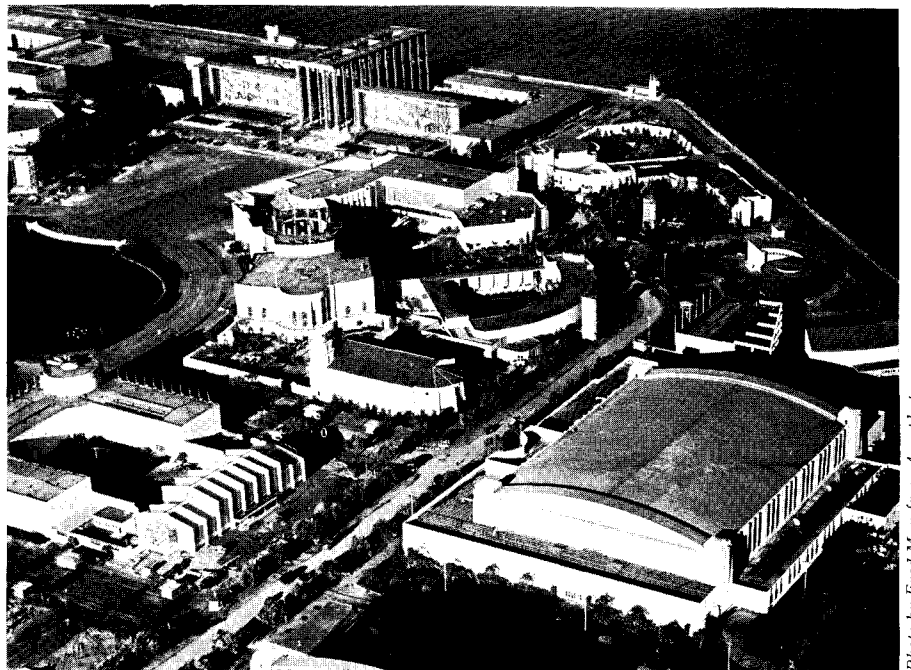
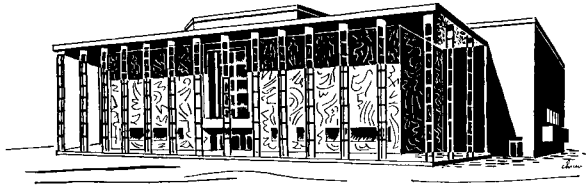


Photo by Fred May from Aerophotos

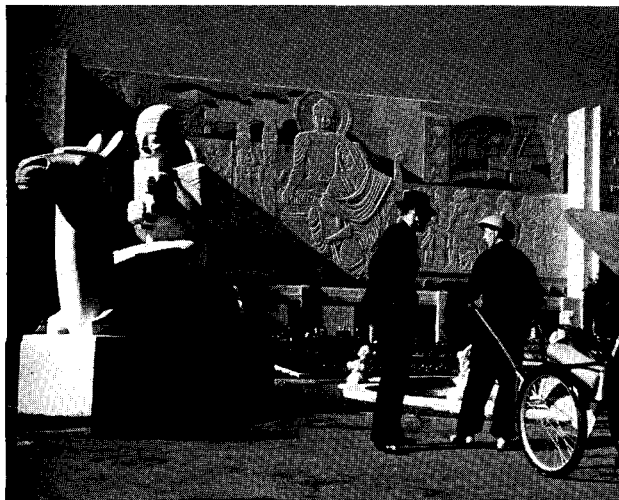
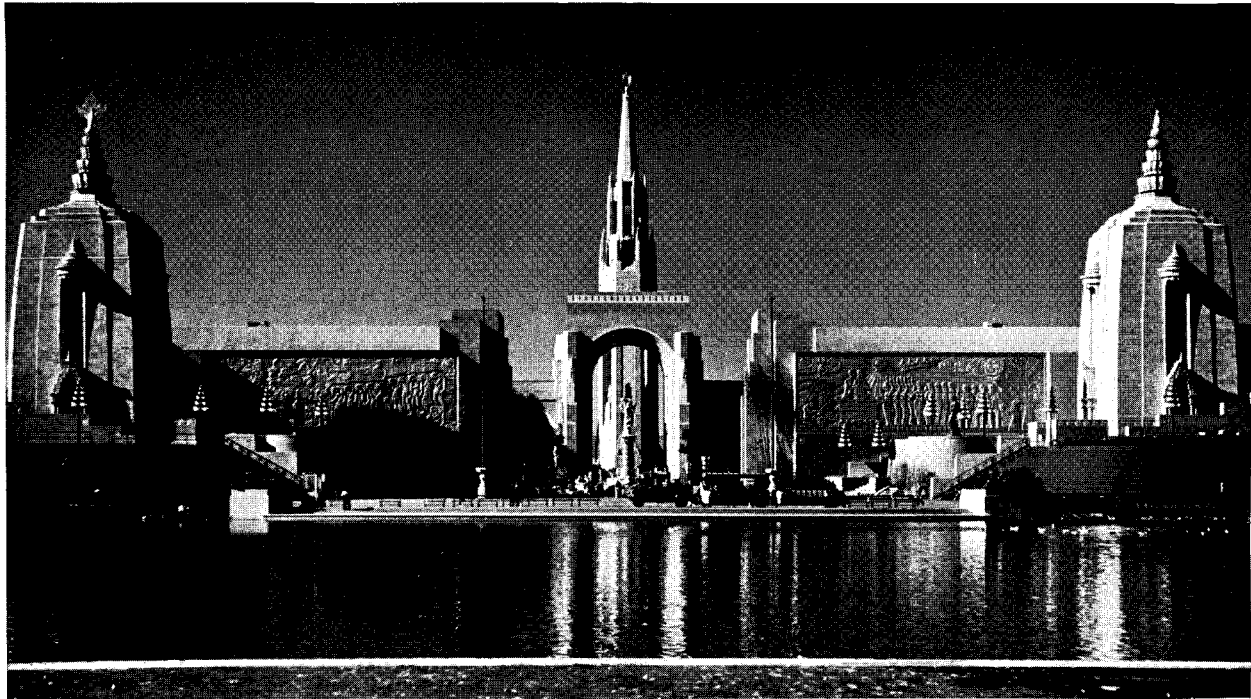
Aerial view, southeast quarter of Treasure Island, showing area treated herein.



The California Auditorium

THE SPECIAL qualities inherent in the over-all design of the Exposition at San Francisco spring from a number of special problems facing the designers. To begin with, the Exposition's compact and coherent plan is the necessary answer to an island location. Then, overland access at the southwestern corner pulled the center of gravity southward, while prevailing westerly winds dictated the massing of the

main exhibition structures along the western shore. The conscious effort to capture the diverse architectural and artistic idioms of the Pacific Basin took two forms: (1) the Architectural Commission's frankly romantic adaptations in the main exhibit halls and (2) the foreign exhibits, many of whose designers employed their national building techniques, materials, and craftsmen in their pavilions.

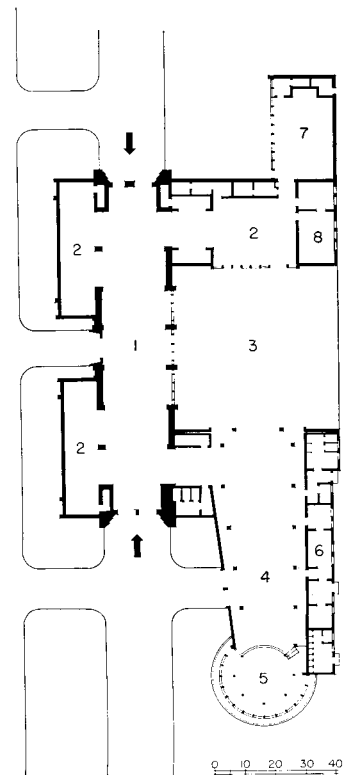




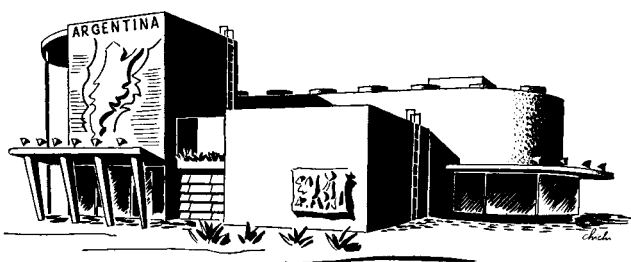
1. UNITED STATES OF BRAZIL

GARDNER DAILEY, Architect

WITH THE main hall supported by timber-and-plywood rigid frames, exterior finish of plywood, and a wide use in the interior of satinwood, rosewood, sucupira, etc., the Brazilian Pavilion is one of the Exposition's many "all wood" structures. Walls around interior court (3) are sliding glass panels, allowing maximum flexibility. The murals over the entrances by Robert Howard, in yellow, brown, green, and gray, are lighted by fluorescent tubing in the louvered reveals. Exterior colors, white and chartreuse; interior, yellow, and grey.

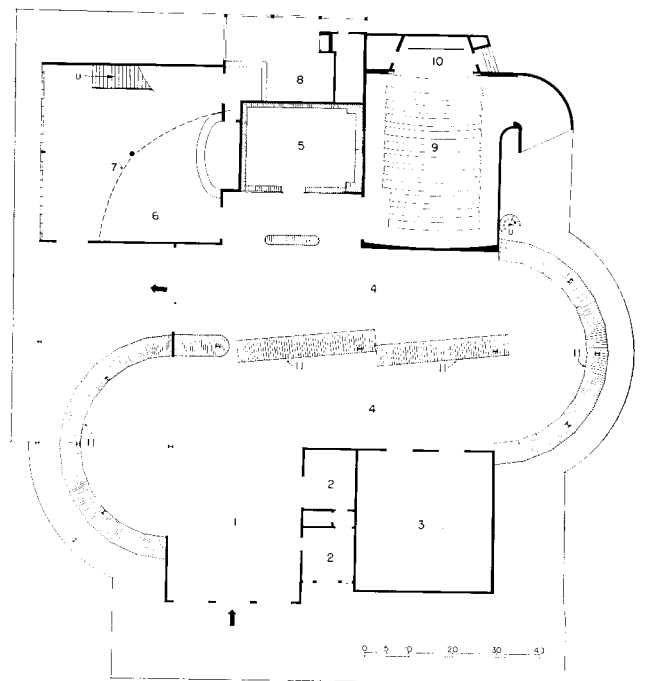


Main floor plan: 1. Main exhibit hall 2. Exhibit rooms 3. Court 4. Cafe 5. Orchestra 6. Kitchen 7. Reception 8. Office

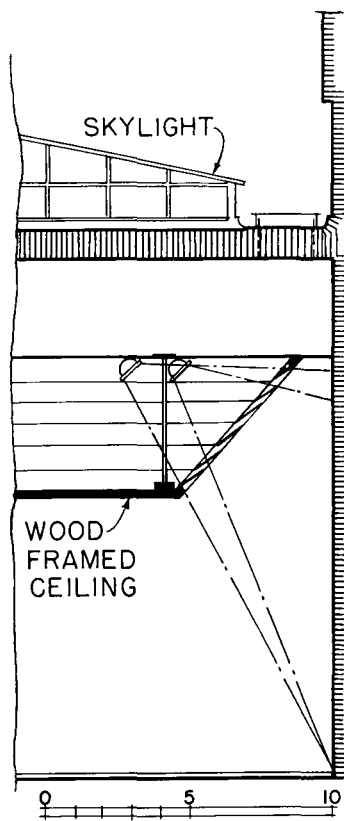


2. REPUBLIC OF ARGENTINA

ARMANDO d'ANS, Architect



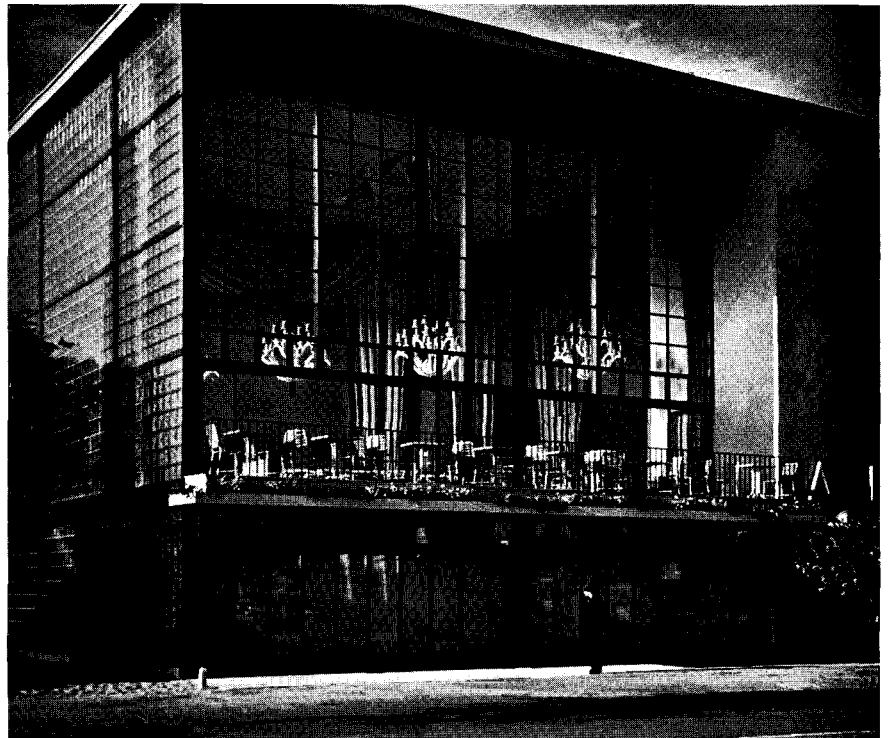
Main Floor plans: 1. Entrance hall 2. Offices 3. Fine Arts 4. Main exhibit hall 5. Library 6. Restaurant 7. Balcony 8. Kitchen 9. Theatre 10. Stage 11. Exhibit cases

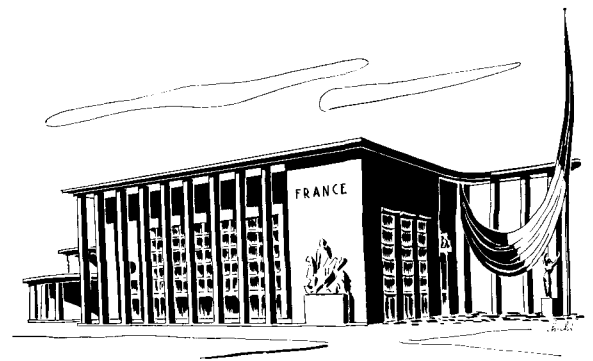
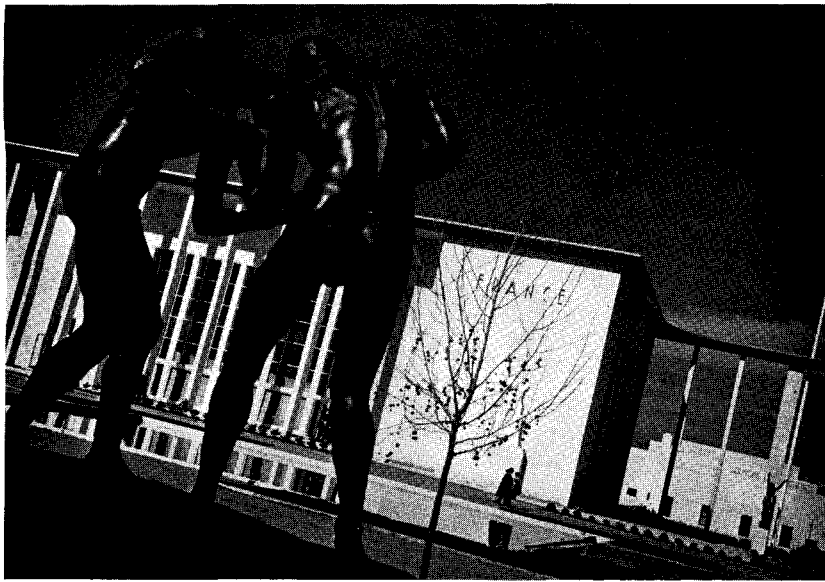


Day and artificial lighting of the Fine Arts Gallery are efficiently and economically achieved by a truncated and inverted pyramid ceiling, sides of which are shuttered with overlapping plates of translucent glass.



PLAN OF THE Argentine Pavilion has been primarily designed for forced flow of visitors through entire exhibit, the library and fine arts gallery being placed off the main traffic stream. Both theatre and restaurant are placed for access from inside or outside the Pavilion; the mirrored walls of the restaurant give the unusual quarter-circle balcony the illusion of being a full circle. Aside from the daylighting in the gallery (above), the exhibit areas elsewhere employ a series of tubular skylights whose depth is sufficient to break up and diffuse all sunlight, except when directly overhead. The embossed relief map over the main entrance (right) is of Argentine copper, floodlighted at night.



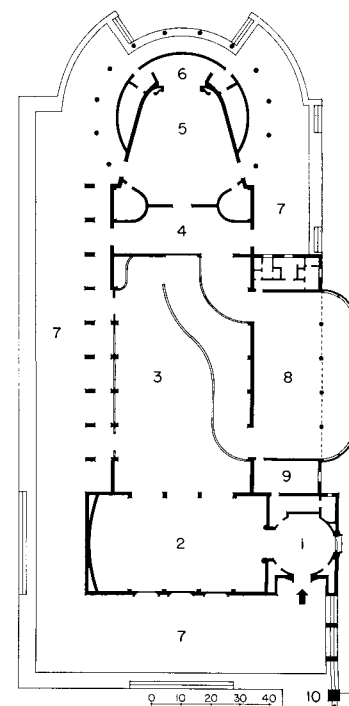
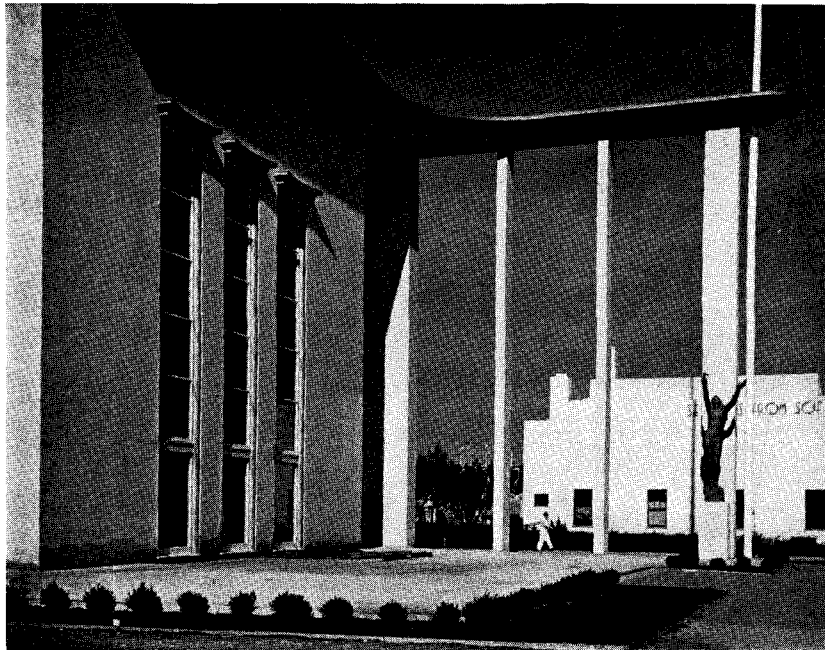


3. REPUBLIC OF FRANCE

GEORGES BESSE and CLAUDE MEYER-LEVY, Architects

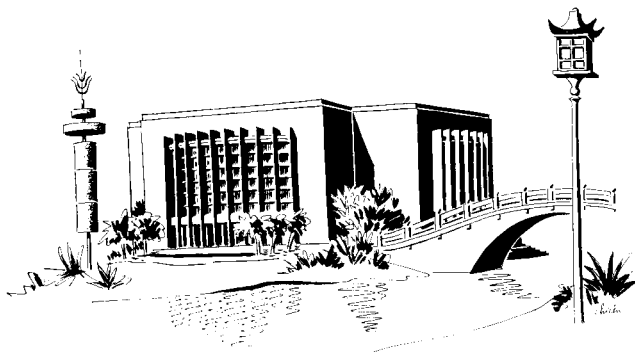
ELDRIDGE SPENCER, Associate

SINCE FORMALITY and a vertical—rather than horizontal—composition was desired, design of the French Pavilion is based upon classic precedent. But the designers have wisely made no attempt to copy classic styles in a wood-framed, stucco-finished building; nor would the location allow a rigidly symmetric structure. Thus, the portico and colonnade have been handled with a novel freshness. The huge tricolor (sketch above) is an integral part of the general design.



Main floor plan

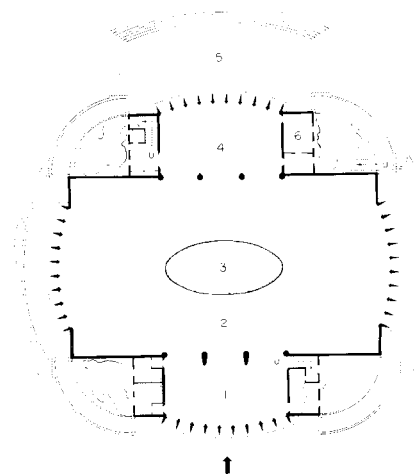
1. Foyer
2. Honor Room
3. Commercial exhibits
4. Vestibule
5. Theater
6. Stage
7. Terrace
8. Tourist Bureau
9. Office
10. Sculpture



4. PACIFIC HOUSE

WILLIAM MERCHANT, Architect
 PHILLIP N. YOUTZ, Consultant

LOCATED ON AN island in the center of the Lake of Nations, this "theme center" for the Exposition is of necessity symmetrical, formal, and architecturally simple. Most novel feature is the use of the four oval bays, which serve not only to stiffen the structure but to illuminate it. The angles of incidence of the plywood fins are calculated to yield maximum refraction of daylight to all interior walls—the interior south wall is thus kept as bright as the others at almost all times—while the process is reversed at night.



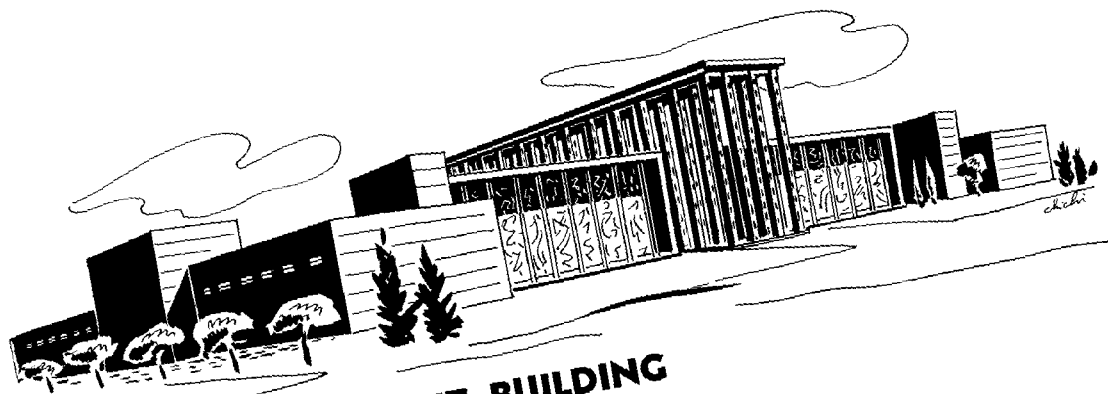
Main floor plan: 1. Entrance lobby 2. Theme Hall 3. Pool 4. Library 5. Terrace 6. Office

PACIFIC HOUSE

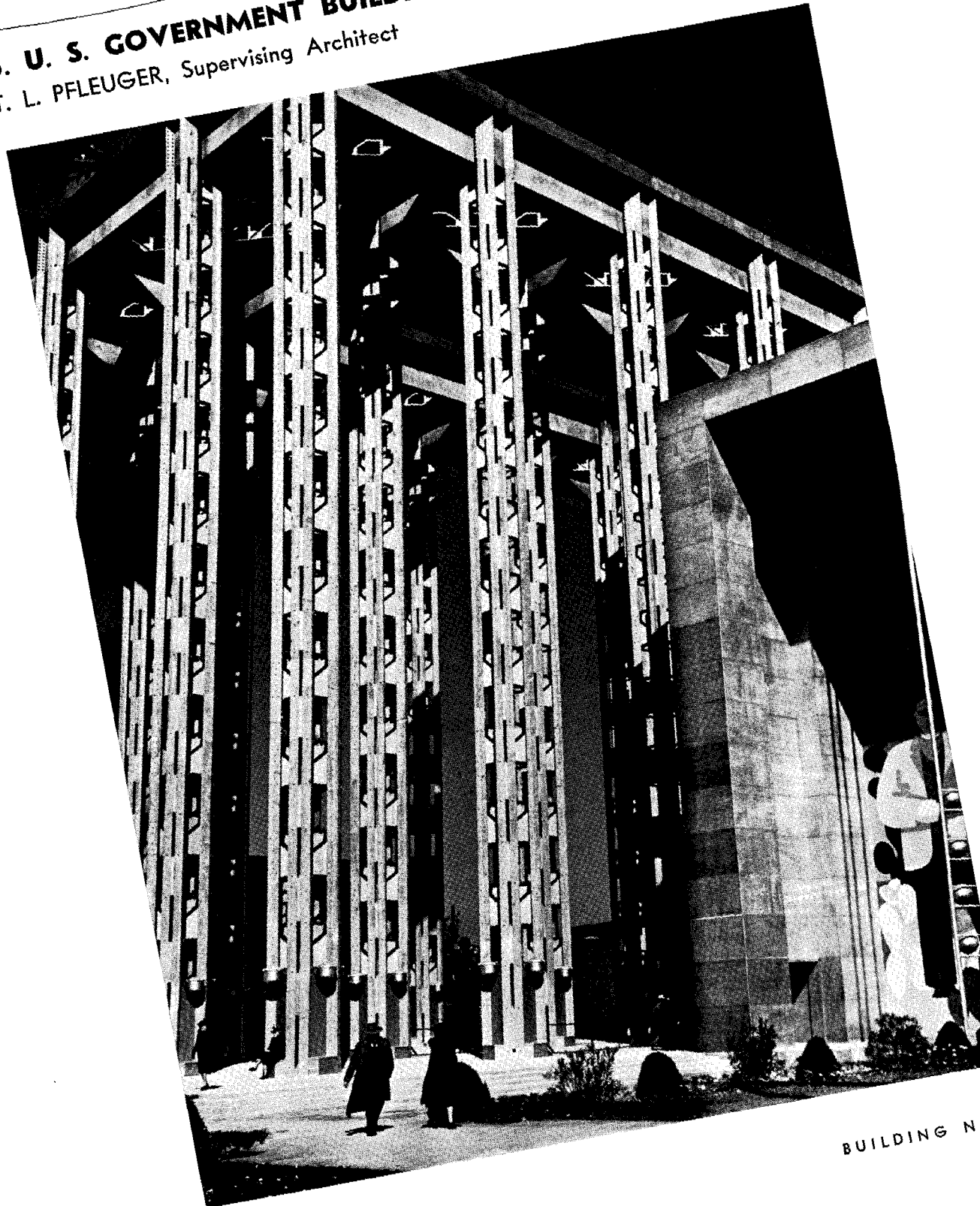


The Theme Hall runs the full height of the building and is centered by a pool containing a terra cotta scale model of the Pacific Basin. The walls carry a series of murals by Covarrubias depicting flora, fauna, races, and art forms of the Pacific Basin. Note minimum interference of fins to visibility.





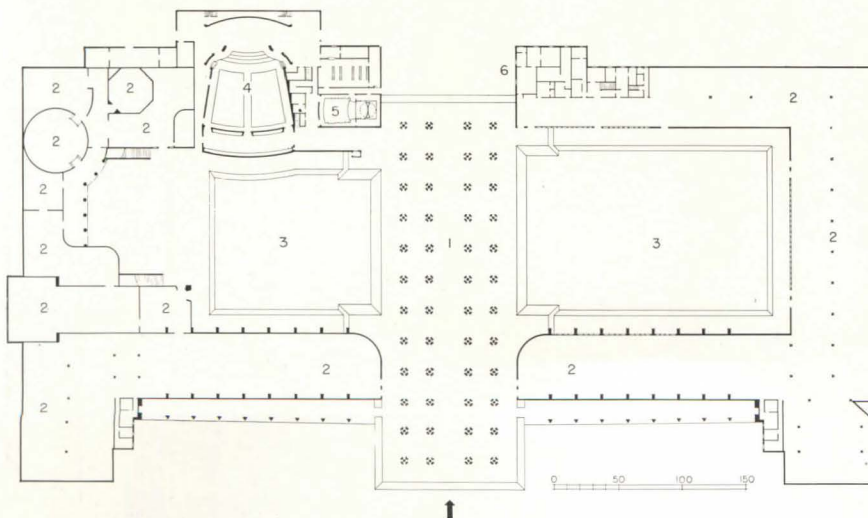
5. U. S. GOVERNMENT BUILDING
T. L. PFLEUGER, Supervising Architect



BUILDING N

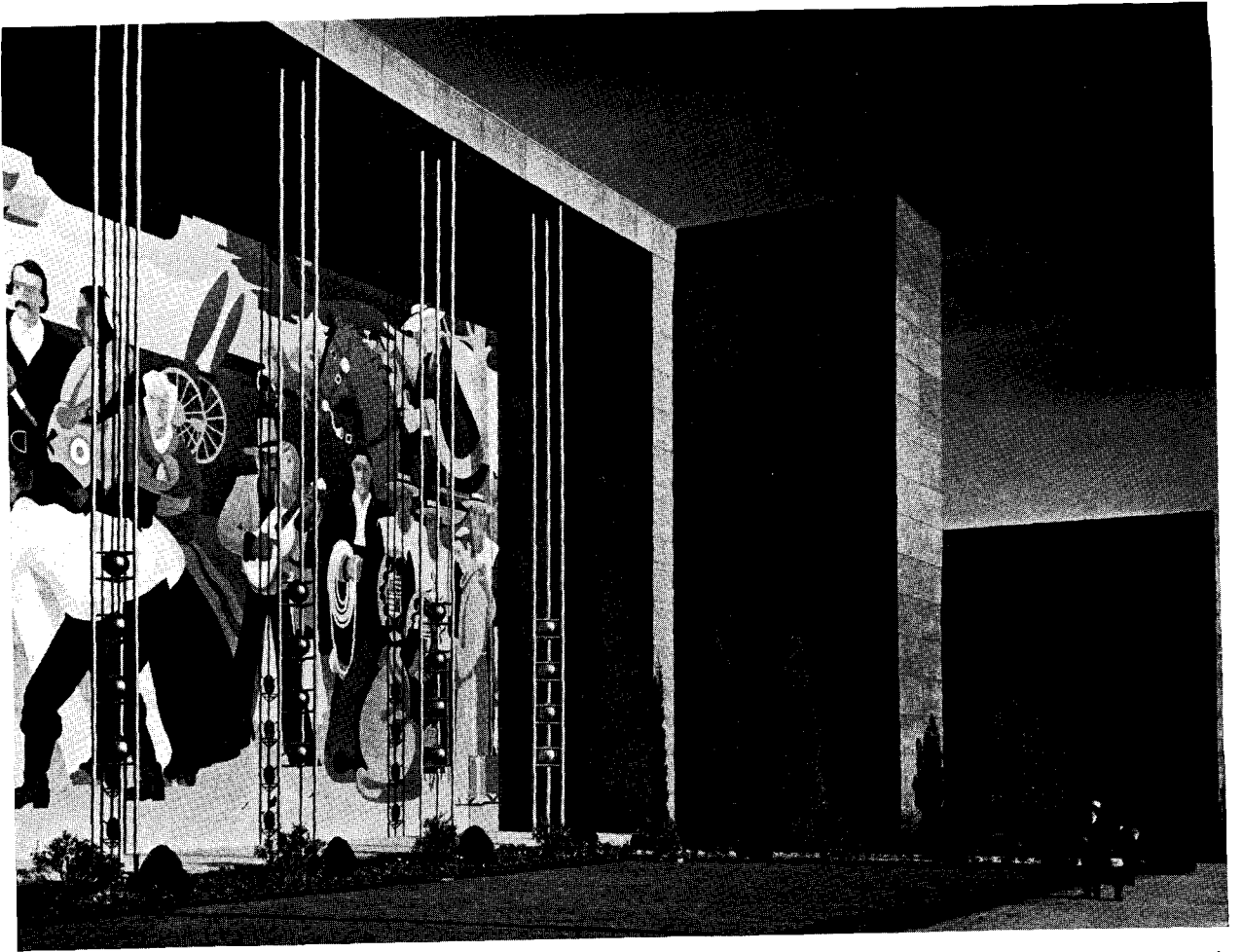
APRIL 1939

GOVERNMENT BUILDING

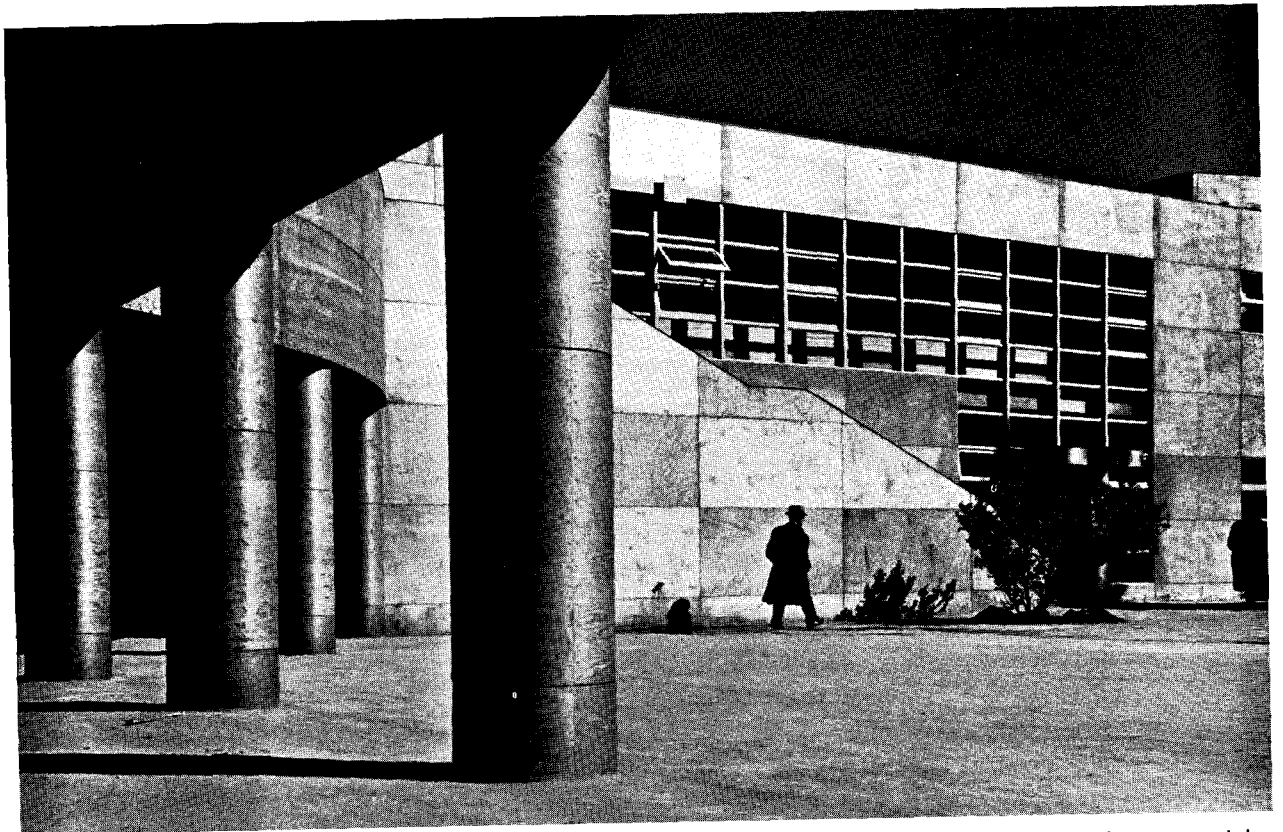


Main Floor plan: 1. Colonnade of States 2. Exhibit areas for various departments 3. Courtyards (left contains outdoor theater) 4. Indoor theater 5. WPA Marionette Theater 6. Offices

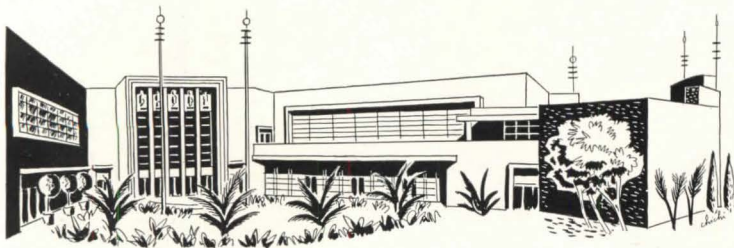
ONE OF THE largest, most successful, and, at the same time, least expensive structures (approximately \$450,000) at the Exposition, the U. S. Government Building is fabricated almost entirely of wood and plywood. The necessity of providing easy access for large crowds resulted in an open plan, while the structure's location at the end of one of the principal axes demanded large mass. This latter requirement has been satisfactorily met by the central colonnade flanked by two wings with heroic murals of States. These wings are actually nothing more than screens, since the exhibit area behind them is less than half as tall. The colonnade itself (see p. 51) is interesting; each column was fabricated of rough-sawn lumber and alternating plywood fins, and then gilded. Exterior surfacing is all plywood in standard panels, finished in a clear varnish, and held in place by special double headed nails which increase the salvage value of the panels.



Detail of one of the mural wings, showing the floodlights carried by a series of triangular pipe columns which serve to lend scale and depth to the mural frame. Aside from natural wood tones, the only color is in murals.



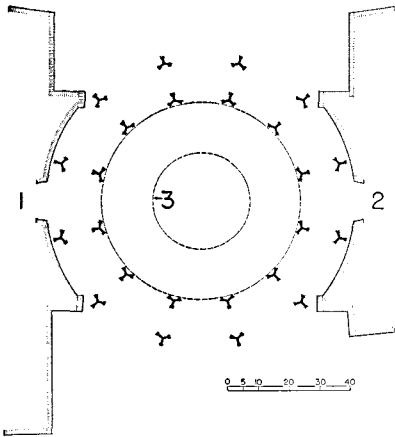
Interior of one of the Courts, showing the way in which plywood surfacing panels served as design module.



6. CALIFORNIA GROUP

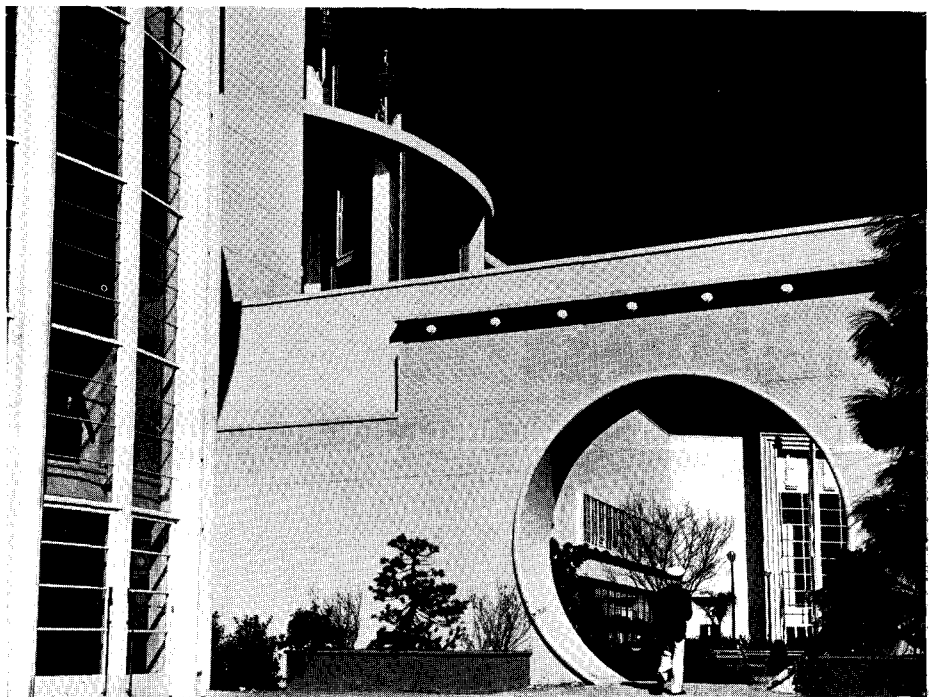
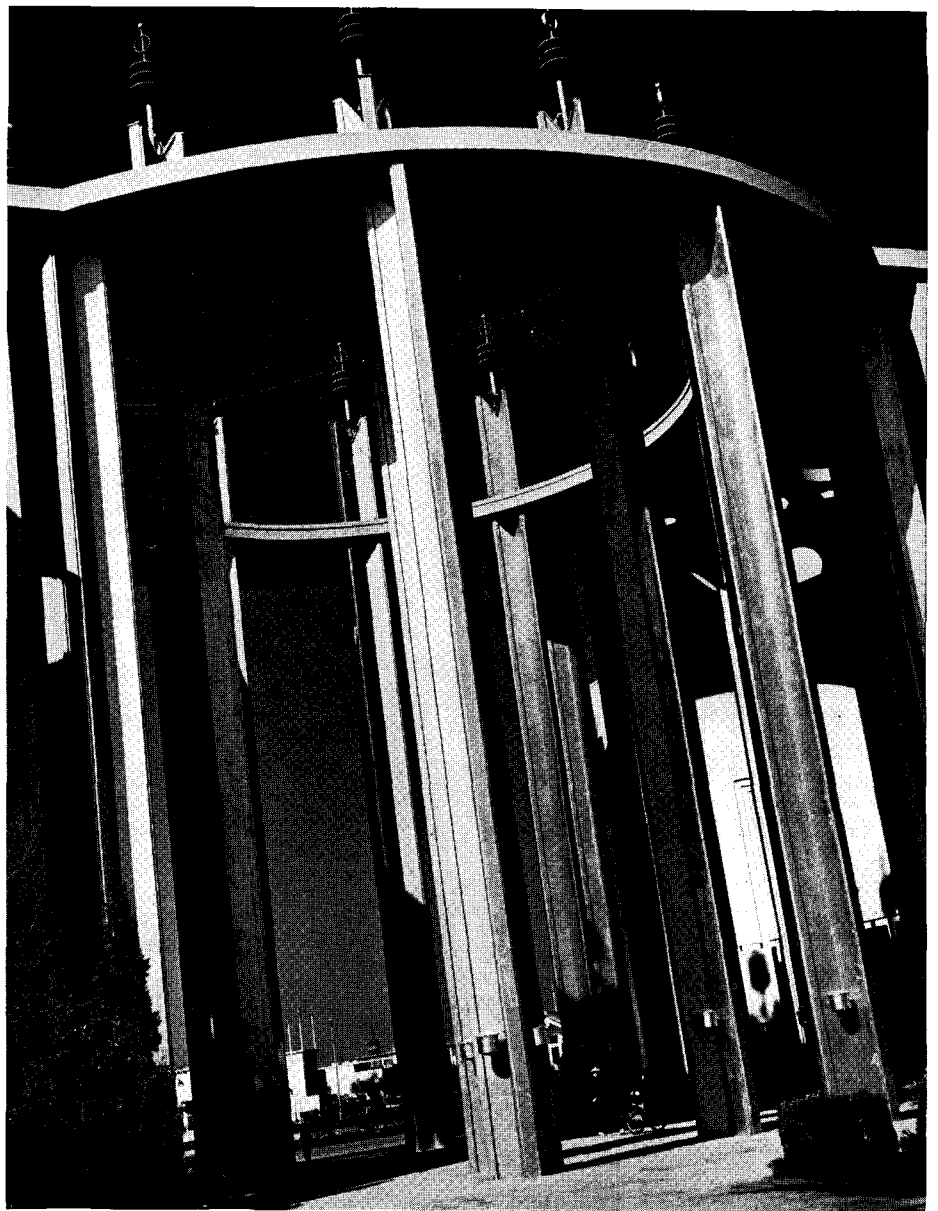
T. L. PFLEUGER, Supervising Architect

FLANKING THE U. S. Government Building at one end of the Lake of Nations, these buildings—California (left) and San Francisco (right)—are connected by a circular Court of Seals (center) which serves as entrance to the county and regional exhibits beyond. Here, again, simple materials have been used with telling effect in structures whose general mass, scale, and detail is more polished than usual exhibition structures. In general, exterior surfacing is of painted plywood on a lumber frame. Aside from the mural under the portico of the California Building, colors are limited and subdued—gilt, terra cotta, tans, chartreuse, with dark green from subtropical planting, white from sculpture.

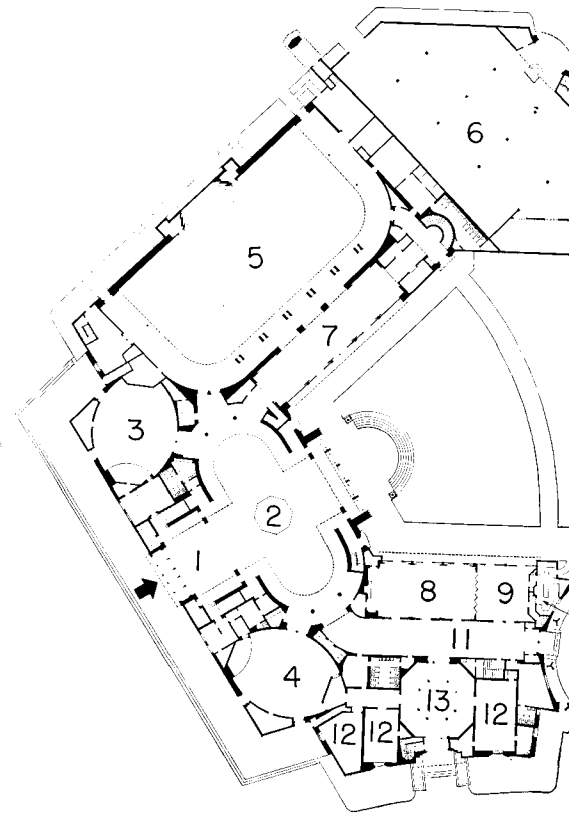
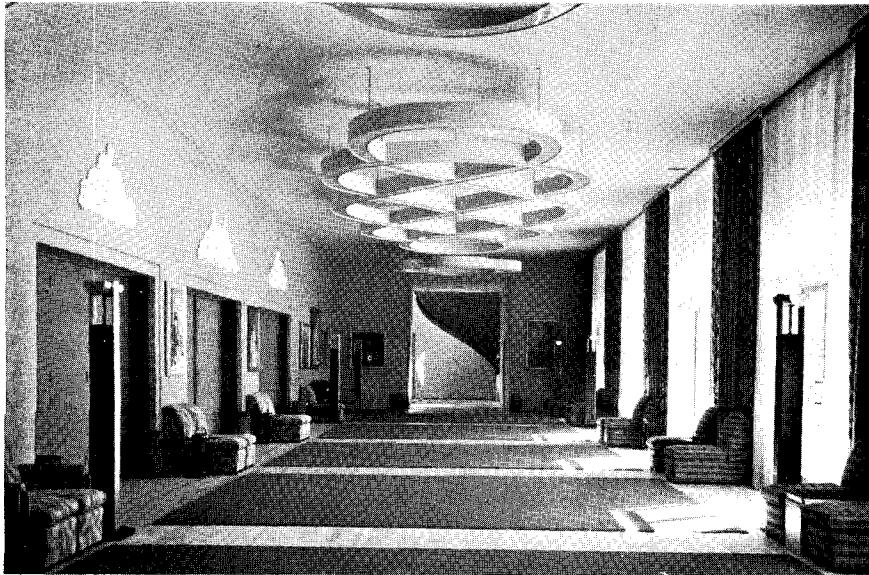
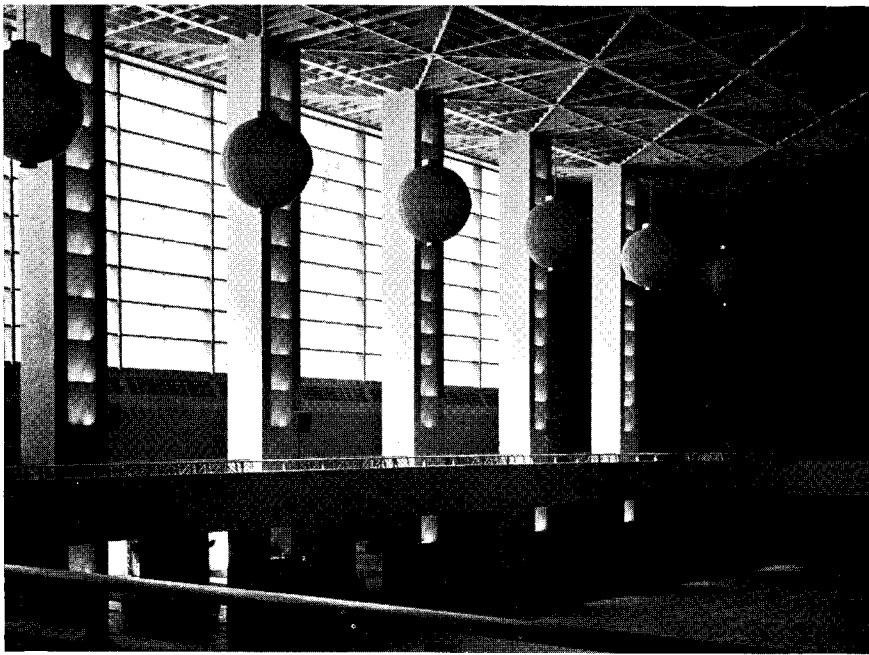
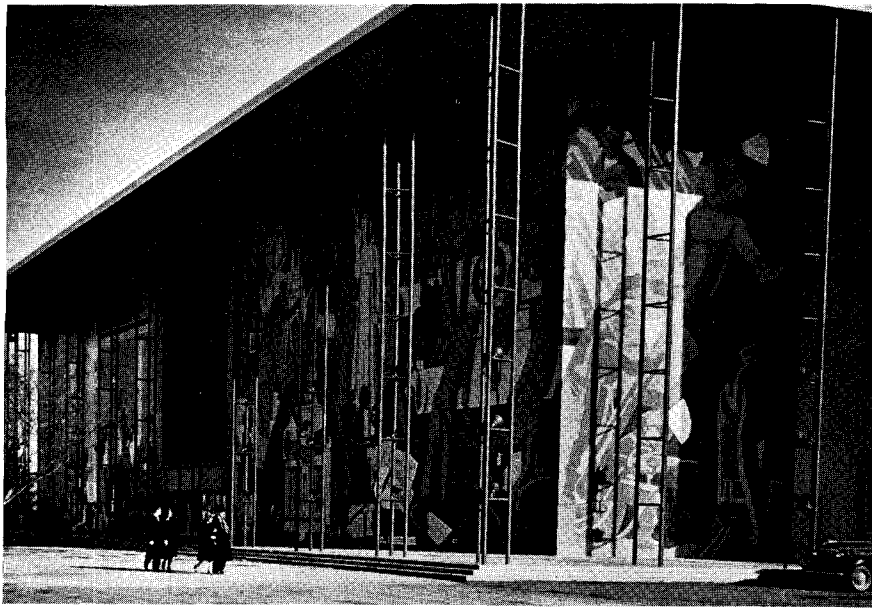


COURT OF SEALS

Another variation of the gilded rough-sawn lumber and plywood columns—this time triangular in plan. The circular opening in the roof (3) is now filled with a circular cloth seal of California. Entrance to California Building (1) faces San Francisco (2).



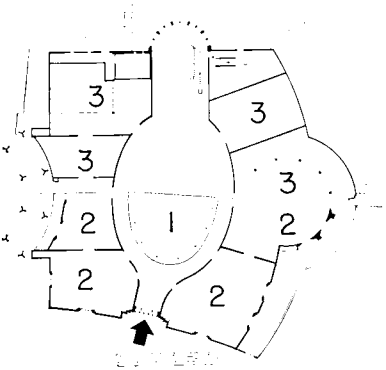
Looking from the walled tea garden of the San Francisco Building, across the triangular court towards the California Building.



Main floor plan: 1. Foyer 2. State Hall 3. Auditorium 4. Diorama 5. State Ball Room 6. Hall of Natural Resources 7. Reception room 8. Women's lounge 9. Dining room 10. Kitchen 11. Promenade 12. Meeting 13. Hall of Peace

CALIFORNIA BUILDING

THE PORTICO, with murals by Lucien Lamboldt (top), is of the same general design as that of the U. S. Government Building. The Ball Room window (center) is glazed with celloglass; the interstices between the bottom chords of the ceiling trusses have been filled with vertical louvers, covered by celloglass and floodlighted. The Reception Hall (3) was designed by Charles Gassion.

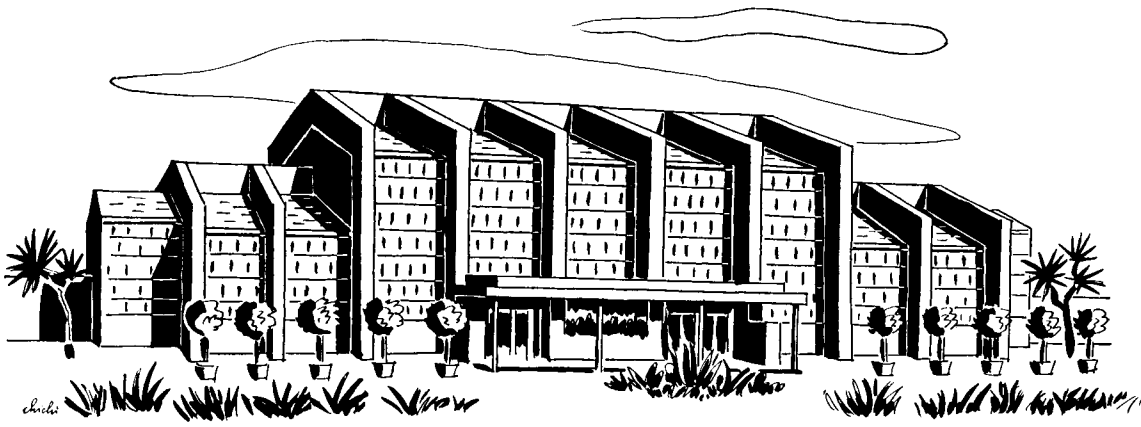


One-half main and second floor plans:
 1. Main hall 2. Exhibitions 3. Reception rooms

SAN FRANCISCO BUILDING

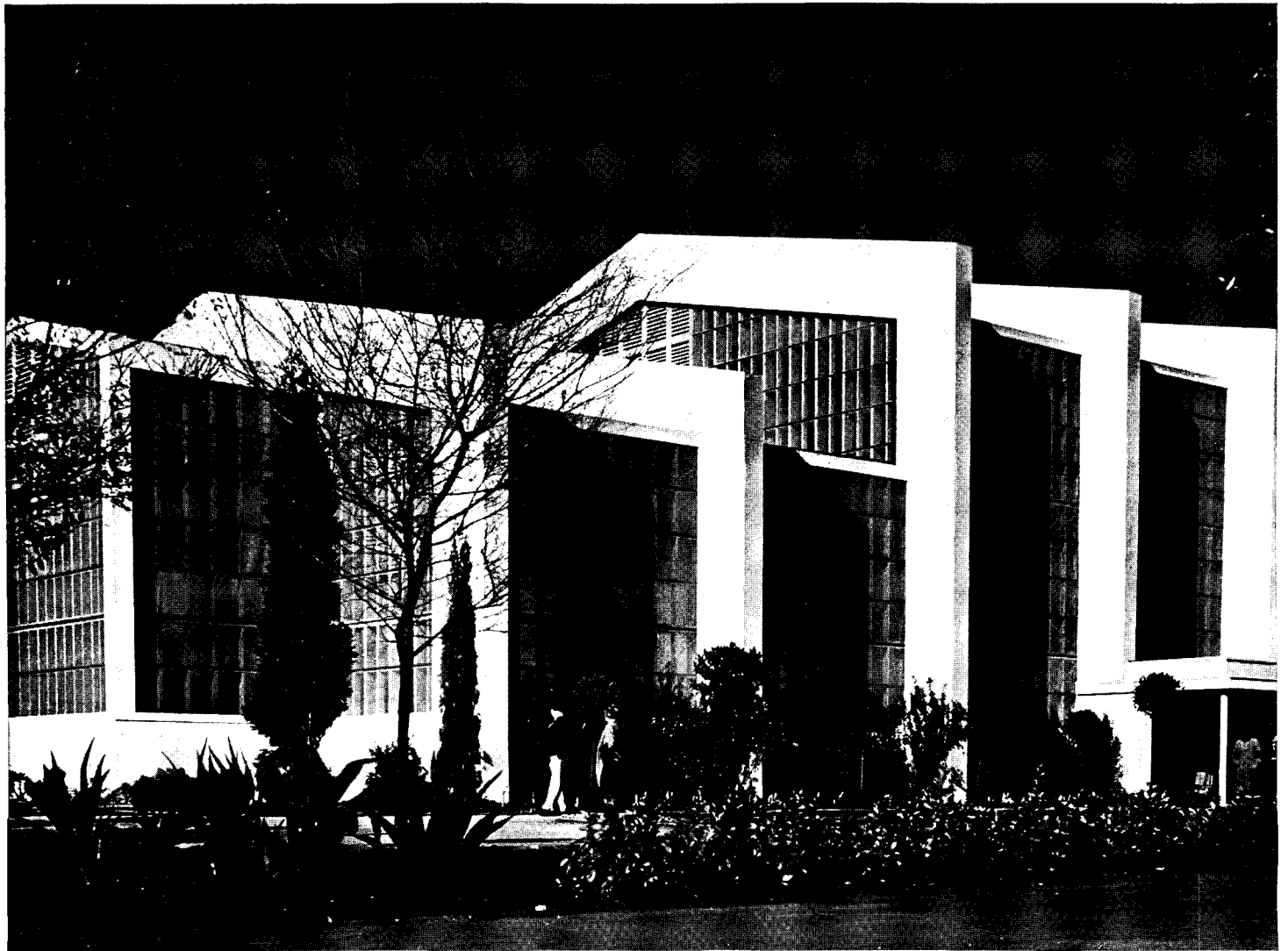
Two of the reception rooms (top), around the oval main hall (right) designed by Clarence Tantau, show a canny use of color and texture to achieve maximum effect. The ring of columns around the oval hall are of steel, built up to an oval section and covered with a stainless steel sheath. The ceiling is indirectly lighted with a series of concentric setback coves and daylighted by an oval skylight in the center.





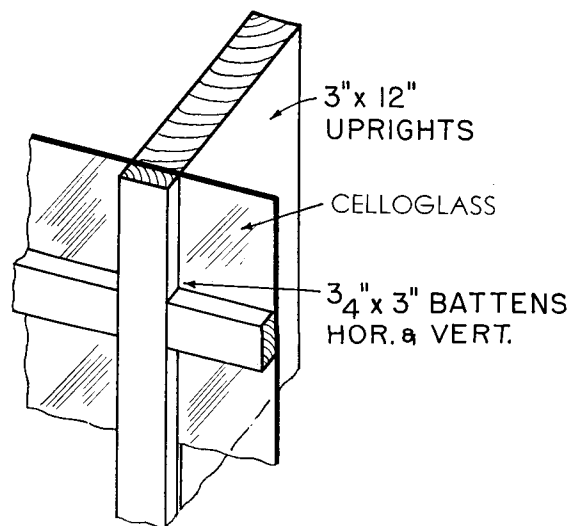
7. HALL OF FLORICULTURE

MARK DANIELS, Architect

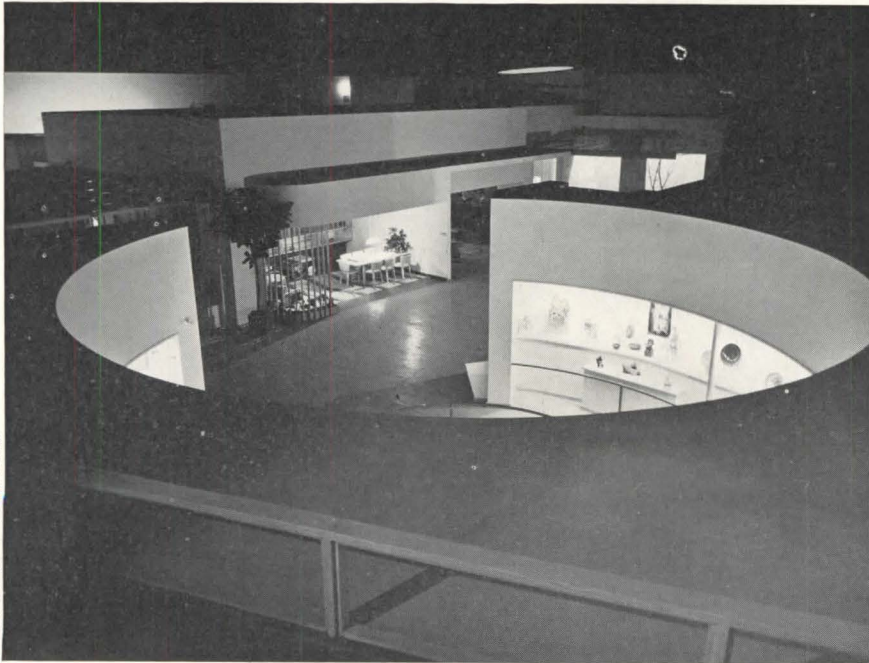




ONE OF THE Exposition's best examples of the use of inexpensive, temporary materials is this conservatory for the horticultural exhibit. Framed entirely of wood, the structure is carried by exterior trusses covered with plywood. Over the exterior of the secondary framing members, cello-glass—a material already widely used in horticultural work as a substitute for glass—has been stretched. Result is both dramatic and practical; although original estimates were lower, necessity for haste gave a final cost of 12c per cu. ft.



Details of typical "muntin" showing manner in which cello-glass is held in place.

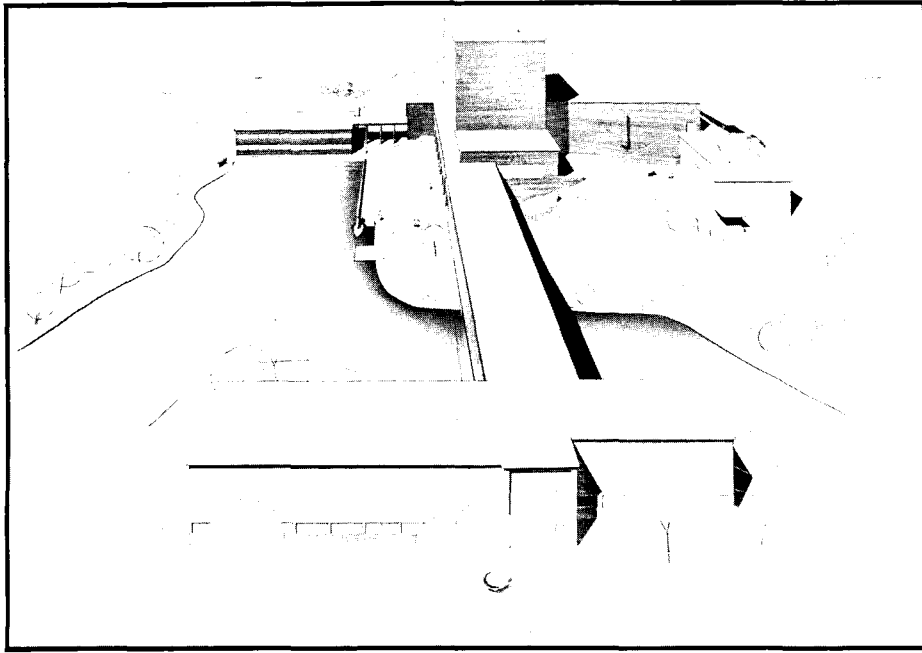


Photos by Roner Sturtevant

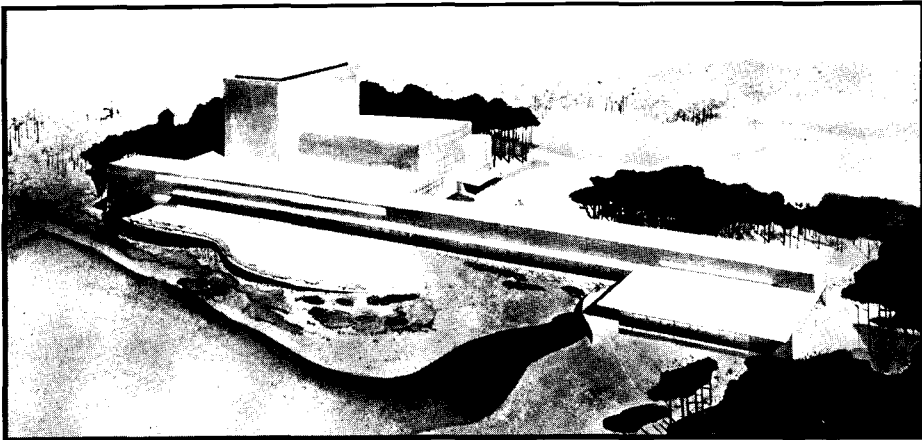
8. FINE AND DECORATIVE ARTS

ORGANIZATION of this exhibition in one of the three permanent buildings on Treasure Island—an airplane hangar—was no simple problem. The material itself was voluminous—European and contemporary American art, decorative arts and crafts—and had to be displayed in a rectangular structure, with no permanent partitions, but also without daylighting. The directors, Mrs. Dorothy Liebes and Shephard Vogelgesong, have divided the space into a series of areas corresponding to the subject matter of the exhibits, relying largely upon bold use of color and light for effect. Note the dropped ceiling in entrance lobby (top) and concentration of lighted surfaces at eye level (bottom) to eliminate dropped ceilings elsewhere.

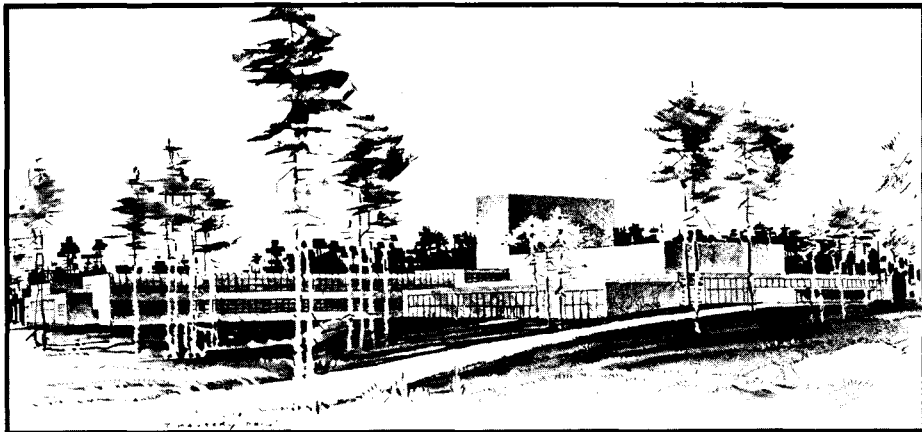
WINNERS OF NATIONAL THEATER COMPETITION ARE ANNOUNCED



FIRST PRIZE: Eero Saarinen, Ralph Rapson, and Frederic James, Associated Architects. "This design was consistent, clear, logical, and straightforward throughout."



SECOND PRIZE: Philip L. Goodwin and Edward D. Stone, Associated Architects. "Operation of school and theater can be separated or can be unified on occasion."



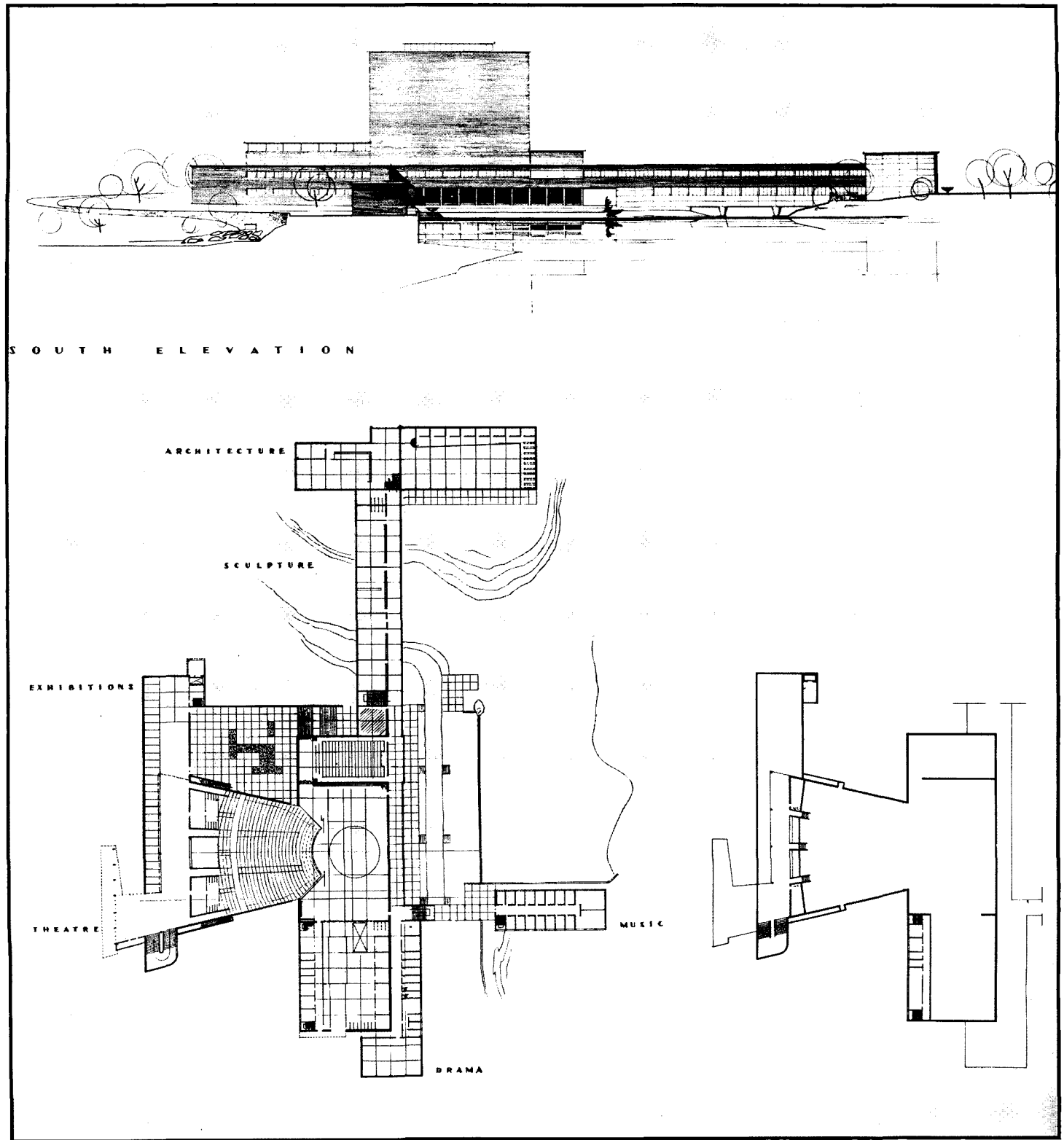
THIRD PRIZE: Philip L. Goodwin and Edward D. Stone, Associated Architects. ". . . basically the same as the first-prize design in disposition of major parts."

THE WINNERS of the competition for the design of "a festival theater and fine arts building" for a site at the College of William and Mary have been announced. The competition was sponsored by the American National Theater and Academy. More than 600 architects filed entry blanks, and 128 completed plans were received within the specified time.

First prize of \$1,000 was won by three young men from the Cranbrook Academy of Art—Eero Saarinen, Ralph Rapson, and Frederic James. Both second and third prizes, \$600 and \$400 respectively, went to Philip L. Goodwin and Edward D. Stone, Associated Architects, of New York City. Honorable mentions, each of which carried a prize of \$100, were: 1. Richard Neutra; 2. Hugh Stubbins and Marc Peter, Jr.; 3. Bissell Alderman and William Hartmann; 4. Henry E. Hebbeln; 5. Will Rice Amon.

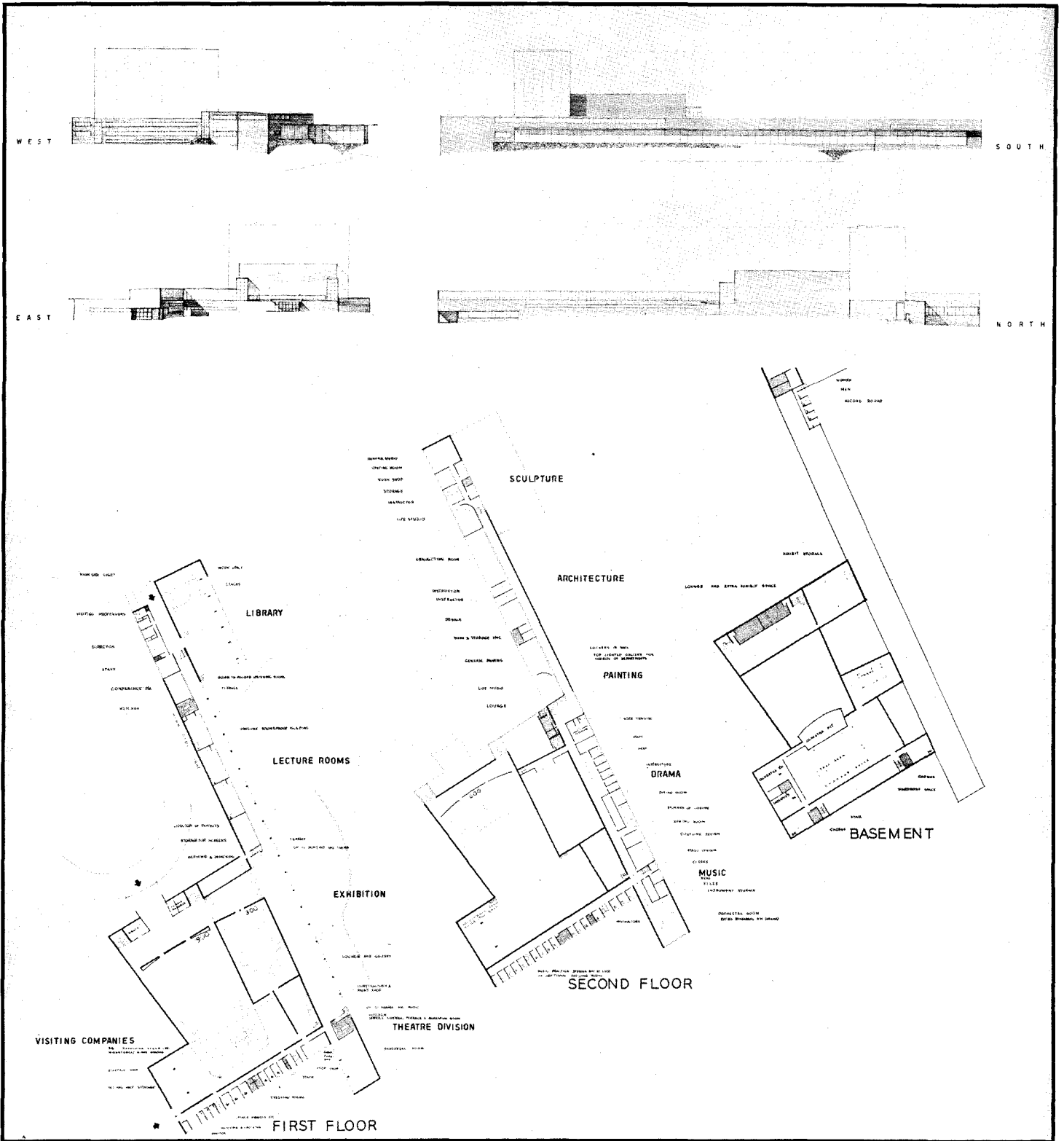
The jury was composed of Lawrence B. Anderson, Asst. Professor of Architecture, Massachusetts Institute of Technology; Leslie Cheek, Jr., Head of the Department of Fine Arts, College of William and Mary; Antonin Raymond, prominent architect; Lee Simonson, scenic designer; Roland A. Wank, Principal Architect, TVA. Kenneth Stowell, AIA, was Professional Adviser.

The report of the jury reads in part: "The analysis and comparison of the 128 designs submitted in this competition lasted from 9 a.m., February 14th, until 6:30 p.m., February 15th. The quality of the solution to an architectural problem such as this depends upon the disposition of the building and its parts for convenient, efficient, and pleasant use. This use involves *first*, the relation of the building to the site and to other buildings in order to use the natural advantages and to minimize the limitations of the site; *second*, the disposition of the major divisions or functions within the general scheme of planning; *third*, the theater planning as an end in itself with the functions of auditorium, stage, workshops, and drama department as major considerations; *fourth*, the planning of the school as such; *fifth*, the considerations of structure and their aesthetic expression as shown on the elevations. With these five points in mind each one of the problems was analyzed, and notes were taken on the ratings of the drawings on each one of the five points mentioned."



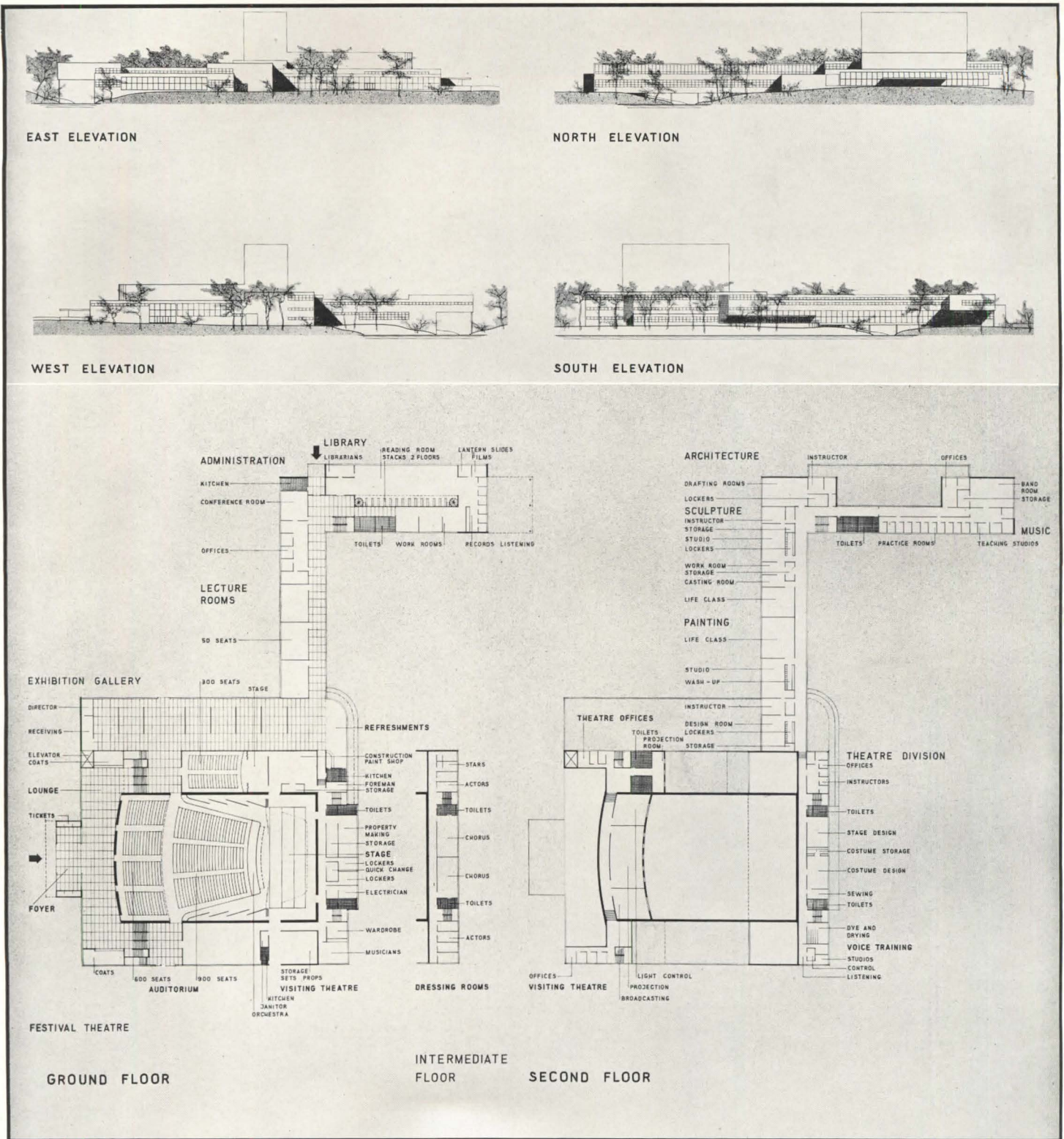
"This design was consistent, clear, logical, and straightforward throughout. . . . The school position is well related to the college campus, and the classroom wing connecting it to the festival theater, the drama section, and the music section. School use and public use are separated so as to obviate cross-traffic or confusion, yet closely related. The drama department is well integrated with the theater, and the music department is close by, yet isolated enough for sound insulation. . . . There are beautiful views of the lake from every department

(except drama) and many terraces. . . . School, administration, and library are logically placed nearest the campus and convenient to the sections of painting, sculpture, and architecture. They are less well related to the music and drama departments, as the connecting corridor along the lake, while broad and pleasant, is rather long. The exhibition space was considered in this design more a part of the public portion than of the school, and is, therefore, related more closely to the festival theater, forming the lobby and its continuation."



"In this plan the major axes of the school and the festival theater run parallel, the school and the exhibition hall flanking the lake. The operation of the school and theater can be entirely separated or can be unified on occasion. There is no conflict of traffic or functioning. The exhibition hall and its lake terrace are convenient to both theater and school. . . . The library and administration offices are again properly near the campus. Lecture rooms are on the first floor and the

large lecture room well placed with respect to both school and stage workshops. The drama division is closely related to both stage and school, and the music division is so placed as to avoid disturbing other divisions. Corridor lengths might be considered excessive and less interesting than if they overlooked the lake. . . . The studios for painting and sculpture have north light. The stage and auditorium are flexible, and good working space is provided for all types of production."

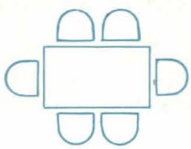


"This solution is basically the same as the first-prize design in regard to the disposition of major parts, with the exception of the exhibition gallery and music department. There is, however, a much greater amount of enclosed cubage without a corresponding gain in use or flexibility. The lounge areas at front and sides might well be used for exhibitions, although a very large gallery is provided. The exhibition gallery is well located for use of both students and public. The lake front and views are not used to the full either by

students or public. The placing of the theater uses the natural grade to advantage and the auditorium is designed for multi-use. . . The construction and paint shop is better related to the large lecture room than to the main stage service entrance. The main stage, while adequate, is less adaptable to the development of elaborate productions than the first-prize design. . . . The school facilities . . . are all convenient to the library, except the drama division. The music division seems rather arbitrarily 'flown' on stilts."



NEW DWELLING UNITS



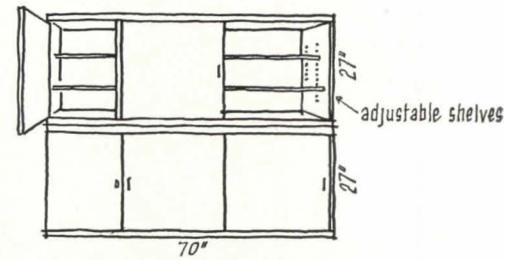
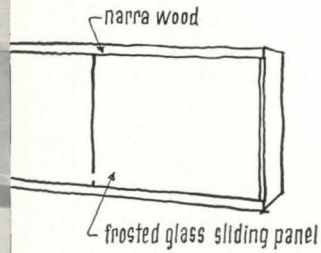
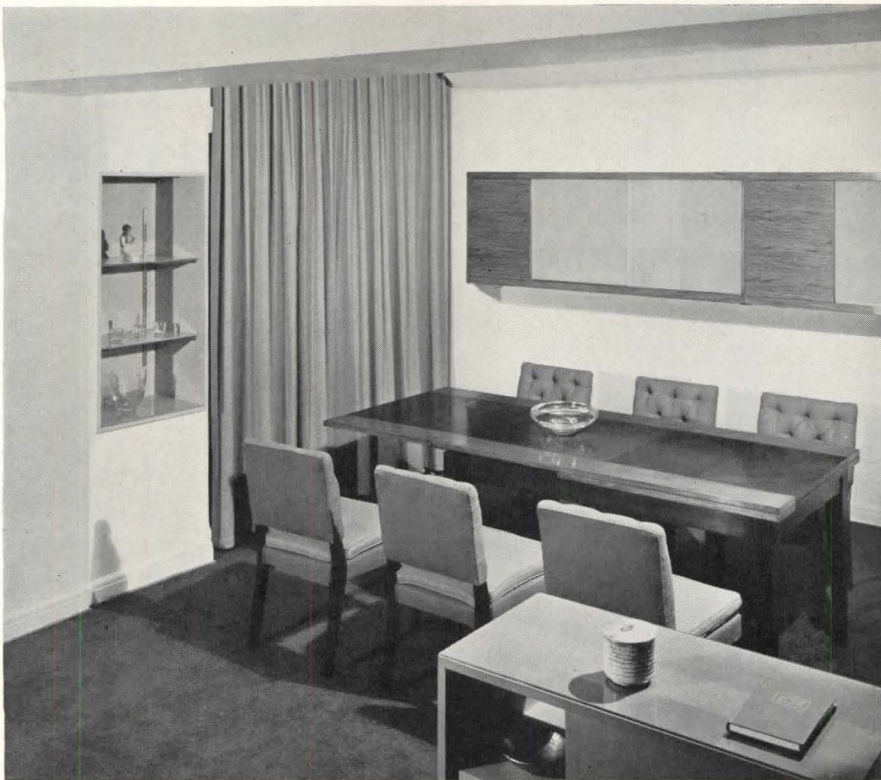
DINING

Color photographs from "1939 Bride's House" of House Beautiful magazine.

Drawings in this section by Torben Muller.

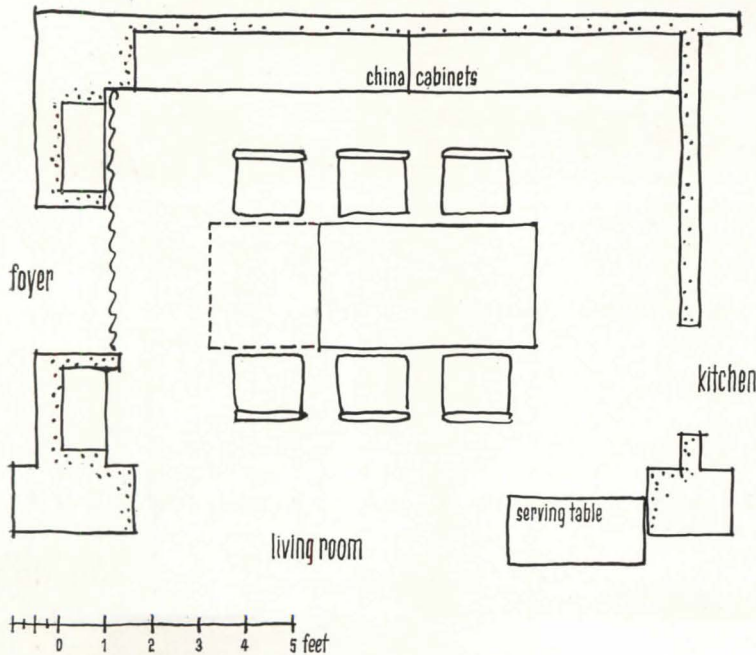
Photos by Samuel H. Gottscho

NEW DWELLING UNITS: DINING



the cabinet is in two sections and can be mounted this way also

WILLIAM FRIEDMAN & HILDE REISS
Designers



WHERE SPACE is at a premium, but mode of living dictates some degree of formality, as in this New York apartment, the dining alcove is a solution used with increasing frequency. Although actually a separate unit in the dwelling, this alcove is part of both living room and foyer, but its limits are defined by a low serving table on the living room side and by draperies of striped pinkish-tan cotton and chenille on the foyer side. All furniture was specially made from the designers' specifications. The table top is of center crotch mahogany with outside bands of narra wood; legs are of mahogany. There are two pull-out leaves; when these are open, the table seats ten persons. Chairs are also of mahogany, upholstered with red cotton homespun; the tie-on cushion is filled with rubberized hair, and covered in red and tan cotton. The china cabinets are hung along one wall, but could be arranged one above the other, as shown above. One section has a silver tray lined with tarnish-preventing felt. The alcove has both indirect cove lighting and flush soffit light. Walls are plaster painted off-white. Carpeting is blue.

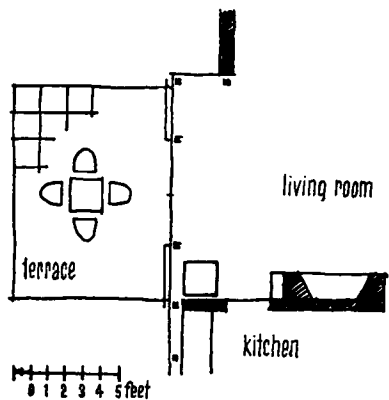
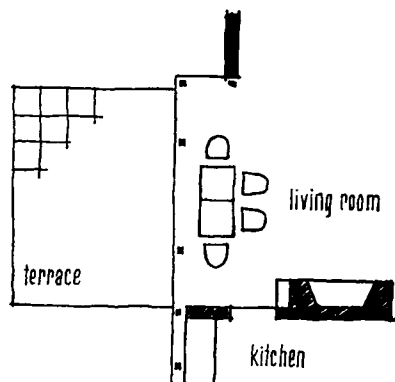
Materials and equipment

Drapery: Kent-Bragaline. Carpet: Mohawk Carpet Co. Furniture: designed by W. Friedman and H. Reiss; executed by Cummings and Engbert. Upholstery on chairs: back and lower part of seat, Morton Sundour Co.; cushion, Stroheim and Romann. Lighting: indirect, Pittsburgh Reflector Co.; flush soffit, Lightolier Co.

HARWELL H. HARRIS

Designer

STRATEGICALLY located to take advantage of a view toward the rugged cliffs of Carmel, California, this dining unit is arranged for complete flexibility. In inclement weather, table and chairs are placed at one side of the living room; otherwise they are transported to the adjoining terrace. In either case, the kitchen is within easy access. The rattan chairs and maple table are in accord with the informality of the living room, and are equally suited to outdoor use. Chartreuse crash curtains hang at either side of the glazed doors. Door frames and rails are painted turquoise.



Materials and equipment

Furniture: tables, custom made; chairs, Rattan Mfg. Co. Doors: frame, Rezo, Paine Lumber Co. Glazing: double strength quality B, Libbey-Owens-Ford; Floors: vertical grain Douglas Fir tongue and groove planks. Lighting: indirect, Clark.



Photos by Fred R. Dapprich

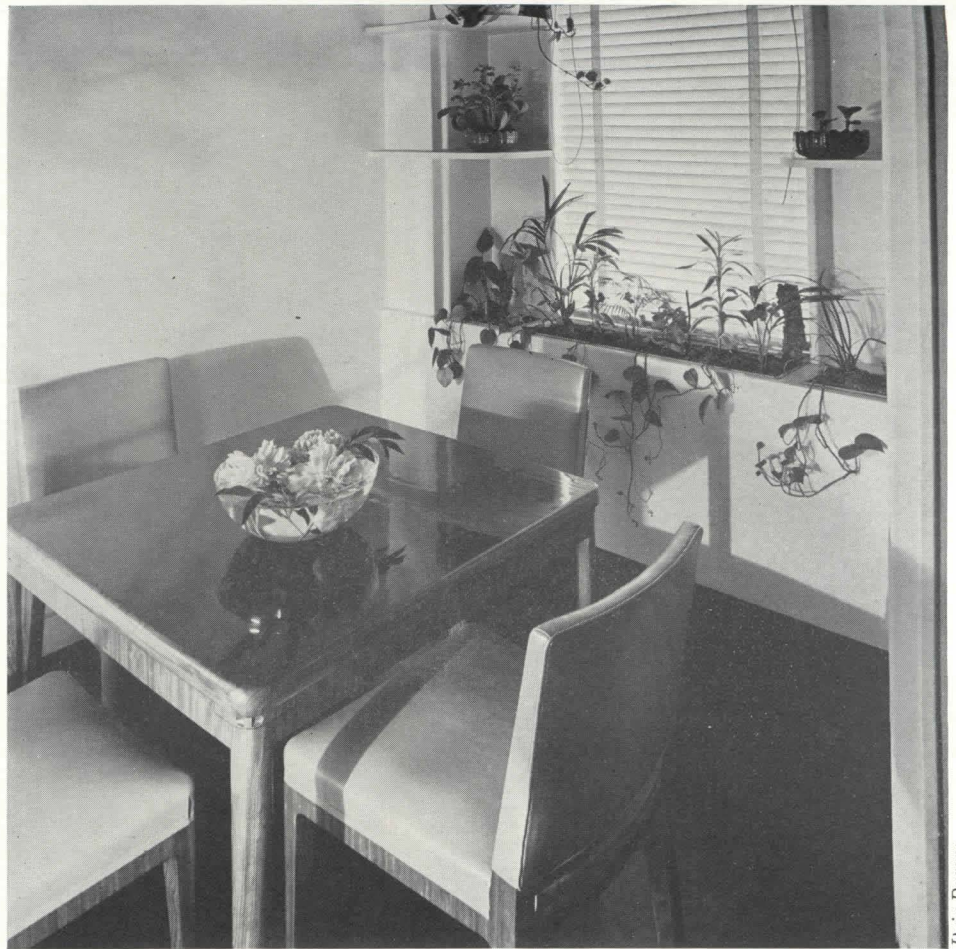


NEW DWELLING UNITS: DINING

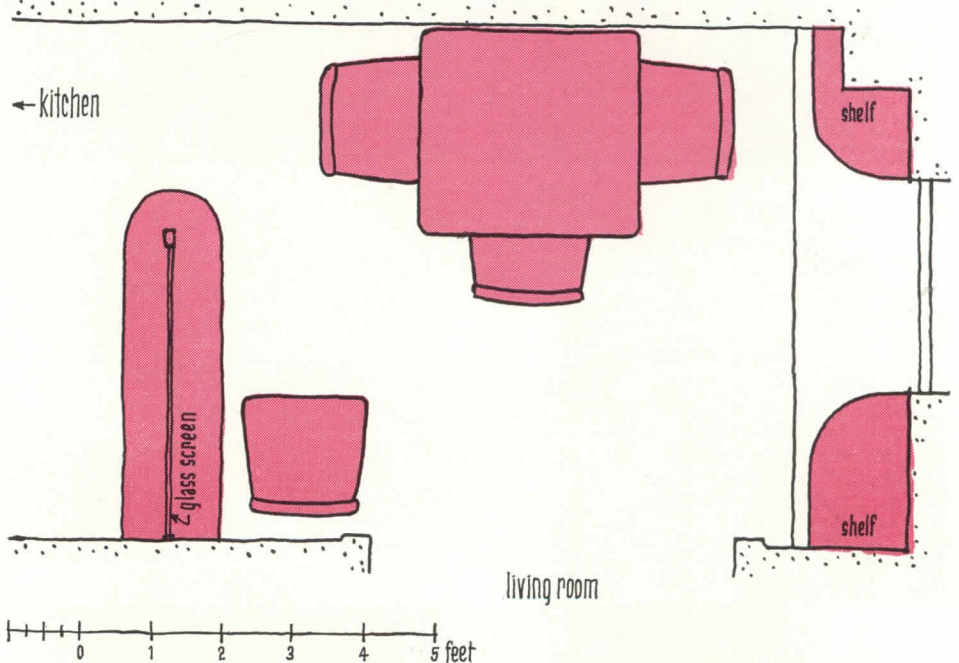
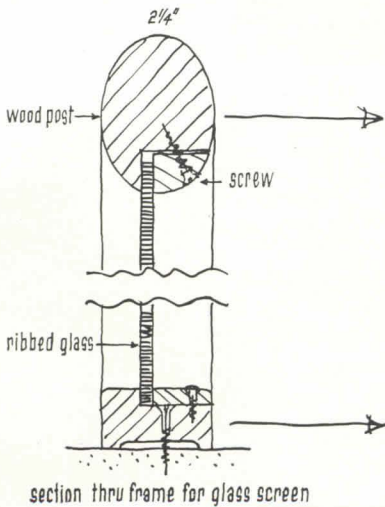
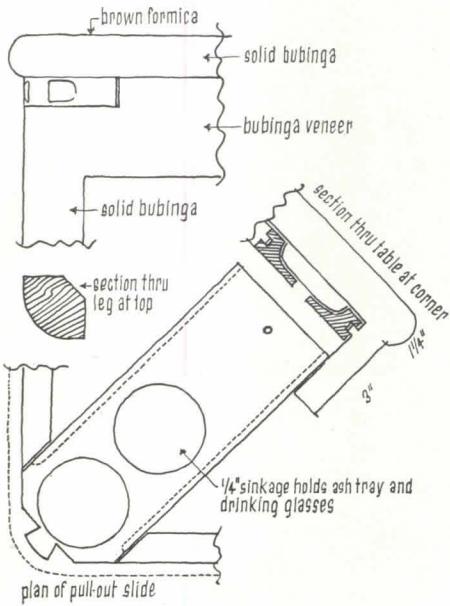


Photo by Drix Durzva

JOSEPH ARONSON
Designer



Doris Duryea



THIS DINING alcove in a New York apartment is also used as a card room. The specially designed table features pull-outs at all corners on which to rest ash trays and drinking glasses so that playing surface is clear. Walls and cup-

boards are lacquered off-white; ceiling is dark gray-blue. The floor is covered with chocolate brown linoleum. Chairs are upholstered in brown-pink leather. The table is polished bubinga wood, topped with formica. Illumination is

indirect on two sides of the room.

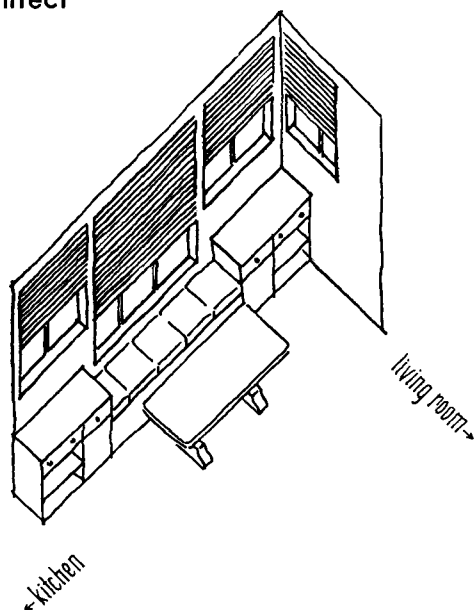
Materials and equipment

Furniture: specially designed by Joseph Aronson. Floor: linoleum, Armstrong Cork Products Co. Glass screen: Pentecor, Mississippi Glass Co. Lighting: indirect on two sides, Lumiline, General Electric Co.

NEW DWELLING UNITS: DINING



MICHAEL GOODMAN
Architect



FRANKLY AN integral part of the living room, this dining unit maintains its identity only by its close association with the kitchen. A cushioned window seat accommodates three persons along one side. The table is a natural-finish maple slab. Cupboards of mahogany wallboard provide storage for linens, silver, and other dining accessories. Walls are also of light ribbon-cut mahogany wallboard. Floors are wood in living-dining room, and tile in service passage. Windows have wood sash and are fitted with natural-finish cedar venetian blinds. Lighting is indirect.

Materials and equipment

Windows: glazing, Libbey-Owens-Ford; venetian blinds, National Venetian Blind Co. Door: flush, Rezo, Paine Lumber Co. Walls and cupboards: mahogany wallboard cut to specification, Oregon-Washington Plywood Co. Floor: service passage, red quarry tile, Gladding McBean Co. Lighting: Lumiline, General Electric Co.

WILLIAM WILSON WURSTER
Architect

FOR MORE FORMAL dining arrangements the separate dining room still holds its own. This California dining room is reminiscent of no particular style, yet forms a suitable background for the Chippendale and Duncan Phyfe furnishings. Walls are plaster, painted sand color; floor is select white oak, stained and waxed. Window sash is sugar pine. Draperies are pleated yellow beige Ionic cloth. Lighting is from wall brackets.

Roger Sturtevant



HENTZ, ADLER & SHUTZE
Architects

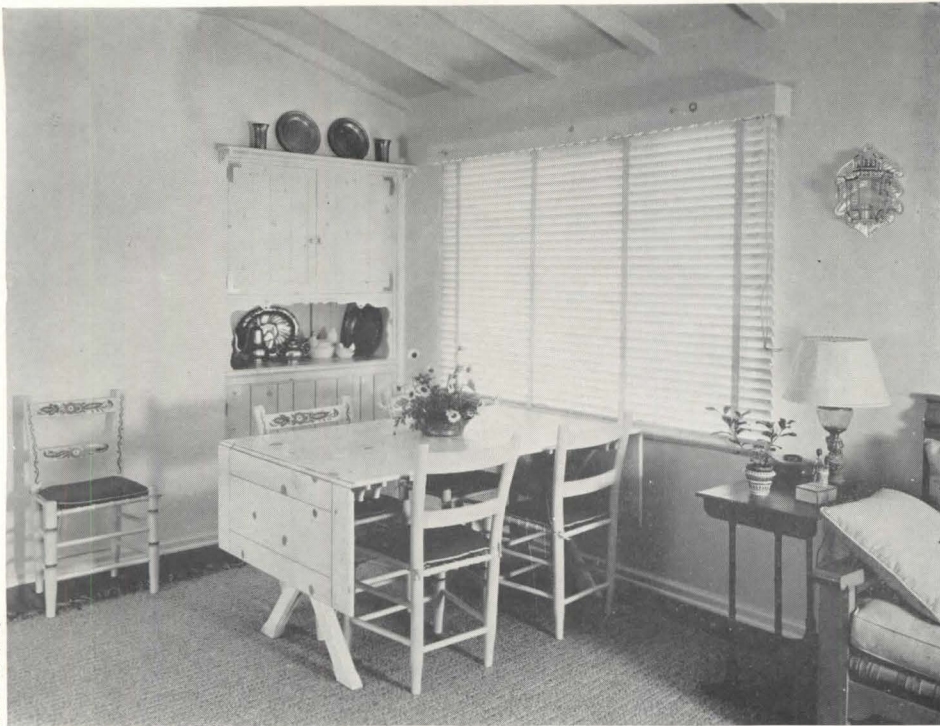
THIS DINING ROOM in a Georgia residence, although formal in layout, has an informal air due partly to the waxed herringbone brick floor, partly to the furnishings. The table is 18th Century Italian; chairs are reproductions of the same period. The chest is Venetian. Inside shutters fold back into the window frames and take the place of window hangings and shades. Walls are painted off-white.

Cottschko



NEW DWELLING UNITS: DINING

CHARLES O. MATCHAM
Architect



Mott Studios

THE PAINTED peasant furnishings of this dining unit offset the more sober living room furniture. Walls are white plaster; floor is oak, covered with a rough texture rug. Table, window valance, and china cabinet are of knotty white pine. The lighting fixture is of period design, glass with polished brass backing.



Hedrich-Blessing

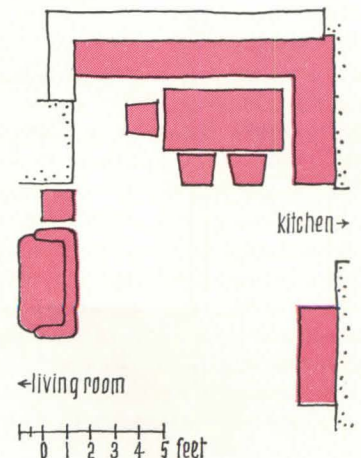
THIS DINING unit in the French Provincial style is located in an alcove off the large stair hall which opens off the living room. The furnishings are all imported antiques. Walls are plaster, painted café au lait on the window side, and quarter-sawn white oak plywood

elsewhere. Floor is of Vermont slate.

Materials and equipment

Windows: steel sash, Truscon; glazing, plate glass. Doors: flush Q. S. natural white oak, Roddis Lumber and Veneer Co. Walls: Q. S. natural white oak plywood, Roddis Lumber and Veneer Co. Lighting: central fixture, Walter G. Warren & Co.

DUBIN & DUBIN
Architects

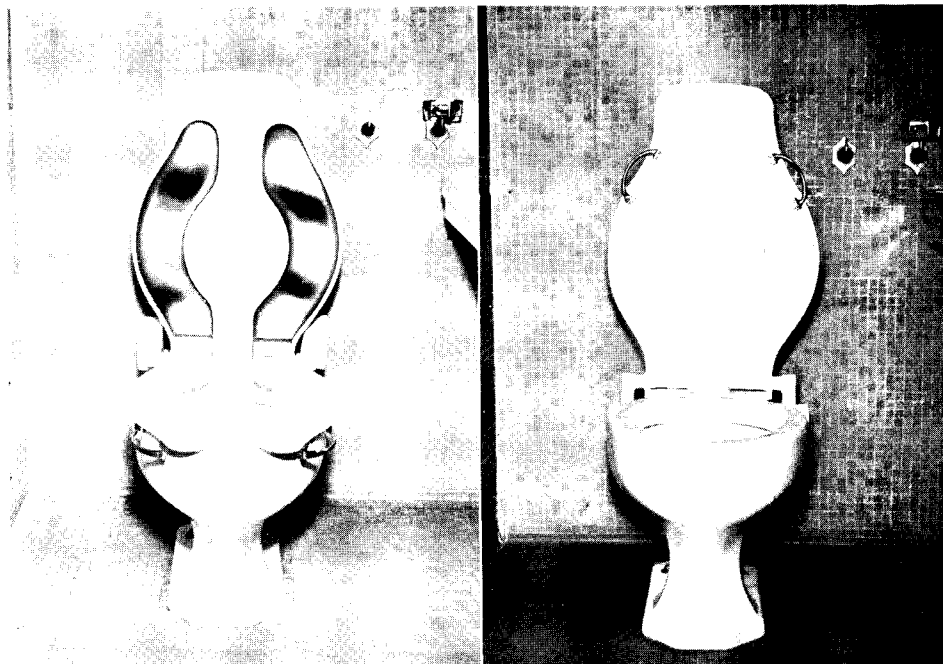


NEW EQUIPMENT

Bactericidal rays eliminate familiar health hazard

TO SAFE-GUARD health, endangered by unsanitary toilet seats, a new use for the Sterilamp (for other uses, see AR, 4/38, p. 72) has been developed by the Steril-seat Corporation, of 122 E. 42 Street, New York, N. Y., which announces the self-sanitizing Sterilseat. The new Steril-seat, it is claimed, offers the first practical, positive, and never-failing means of keeping the toilet safe for each individual. The complete sanitizing unit consists of a seat, Sterilamp in a special cabinet, automatic mechanism; operating costs approximate that of a 20-watt light bulb. When not in use the seat is quietly moved by means of counterweights to the upright position. Immediately upon the user's entering the cabinet, the Sterilamp automatically floods the seat with germicidal rays; a new reflective lining in the cabinet guarantees maximum efficiency. Sterilseat may be installed on any standard closet, plugged in to any light socket.

After making bacteriological tests on the Sterilseat, the Westinghouse Electric and Manufacturing Company concludes that this application of the Sterilamp "will give its users a toilet seat that is more germ-free than it has before been



The seat is lowered by means of conveniently placed handles; when not in use, it automatically rises to an upright position, where it is subjected to the germicidal rays of the Sterilamp.

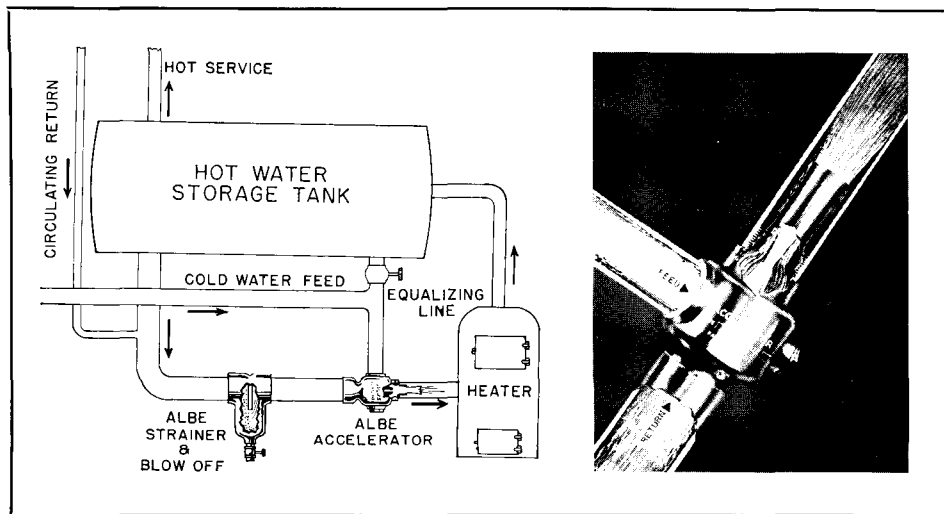
possible to produce by any other means of sterilization such as chemicals or other methods now known." Swabs taken from the seat, which was contaminated with a solution of E Coli, were transferred to autoclaved petri plates

which contained sterile agar to promote bacterial growth. After 48 hours incubation, the plates were examined under a powerful microscope and it was found that 98.52% of the bacteria had been killed by the ultraviolet radiation.

Simple automatic device assures quick supply of hot water by stimulating circulation.

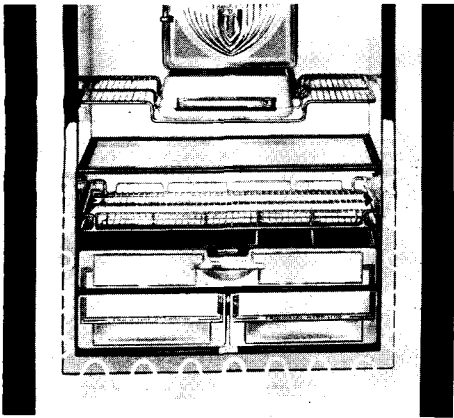
GREATER EFFICIENCY of hot water systems is reported from the use of a new automatic accelerator which operates without a motor. According to field reports on various installations, this hot water circulation accelerator, announced by the Albe Accelerator Division of the Albe Pump Corp., Brooklyn, N. Y., has resulted in savings of 25% to 60%. The Albe Accelerator is a device which may be placed on any hot water system. It operates automatically whenever a faucet is opened. Its use prevents incoming feed water from chilling the heated water already in the storage tank. The maintenance of storage water at a lower average temperature, without the loss of high temperature at the faucet, is also made possible. No maintenance is required as there are no moving parts.

The Accelerator comes in four sizes—for domestic, restaurant, apartment, hotel, and industrial uses. Prices range from \$20.00 to \$85.00.



The usual pressure in the intake line forces cold water at a high velocity through the nozzle placed in the center of the accelerator. This high velocity stream, discharging into the throat, creates a suction which pulls with it six to ten times as much warm water from the bottom of the tank. This stream is then drawn through the neck of the accelerator into the heater. Heat is thus rapidly absorbed by the accelerated water and is transferred quickly into the tank, avoiding heat dissipation.

NEW EQUIPMENT



New "Cold Wall" construction for better food preservation.

TO ELIMINATE the "moisture-robbing circulation" which causes food spoilage in the usual refrigerator, the Frigidaire Division of the General Motors Sales Corporation developed its new Cold Wall Frigidaire. This new unit incorporates two basic methods of applying the results of mechanically produced low temperatures, the cabinet being divided into two completely separate sections by means of a glass dividing shelf. There is no connection or air circulation between the top and bottom sections.

The top section operates in the conventional manner, providing for ice freezing, dessert freezing, and below-freezing storage functions. There is also ample space here for storage of foods not susceptible to rapid drying or discoloration, such as eggs, beverages, foods in containers, or canned goods temporarily stored for chilling purposes.

The application in the lower section of the radiant principle of heat transfer, results in a practical equalization of temperatures. Low temperatures are attained in combination with very high moisture content. Under these conditions, resulting moisture loss from foods is practically nil. It is also claimed that natural color, flavor, and freshness are preserved, and the intermingling of odors and tastes is considerably reduced.

The Cold Wall cooling coil consists of a series of loops of tubing. There is no physical connection between the refrigerant in the upper freezer and the refrigerant in the tubing, that in the lower tubing being hermetically sealed. Heat from the gas in the secondary system passes to the freezer unit by conduction through the metal walls.

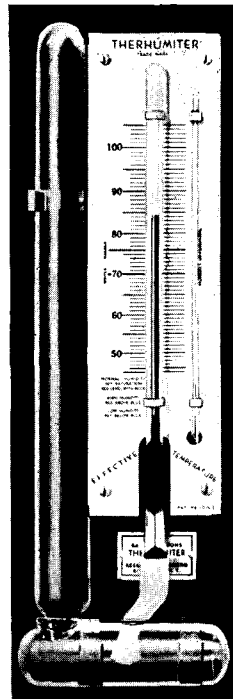
Thermometer superseded by more precise instrument.

NOW IN COMMERCIAL production is the Bailey-Parsons "Therhumiter," a new instrument which indicates at a single reading a composite-value temperature, humidity, and air motion. Designed by John R. Parsons, consulting physicist of New York City, the Therhumiter is intended to fill the specific need for "a common measuring stick which will permit everybody, technical or non-technical, to speak the same language. The three main factors in comfort—temperature, humidity, and air motion—must be rolled into one index before the public can tell us what it wants."

As long as the conception of air conditioning revolved around facilities for heating the air, the thermometer was an adequate gauge. Today, however, with the use of mechanical devices which control all three factors, it is necessary to have an instrument in popular use which measures effective temperature, or, as Mr. Parsons spells it, Effective TEMPAIRTURE.

The accompanying illustration shows the Therhumiter with a center column ending at the bottom in two communicating bulbs containing red spirits. The upper bulb is responsive to heat (air temperature) only; the lower bulb is responsive to relative humidity and air motion. The result is registered on the scale above as a composite value indicating effective temperature directly. The two diamonds on the scale represent the winter and summer comfort zones, with 70° effective temperature the optimum for winter, and 76° for summer. The wick of the wet bulb is

The Bailey-Parsons Therhumiter provides one index for the three comfort factors—temperature, humidity and air motion.



kept saturated by immersion in the lower reservoir. A uniform water level is maintained by a removable, automatic-feed reservoir, standing upright at the left, with its open end inserted into the lower reservoir. The separate, blue thermometer on the right indicates air temperatures only.

Although no commercially practicable means of utilizing the Therhumiter as an automatic control (like the thermostat) have as yet been perfected, several such installations are already operating in hospitals, telephone exchanges, etc. It is planned eventually to market such automatic controls.

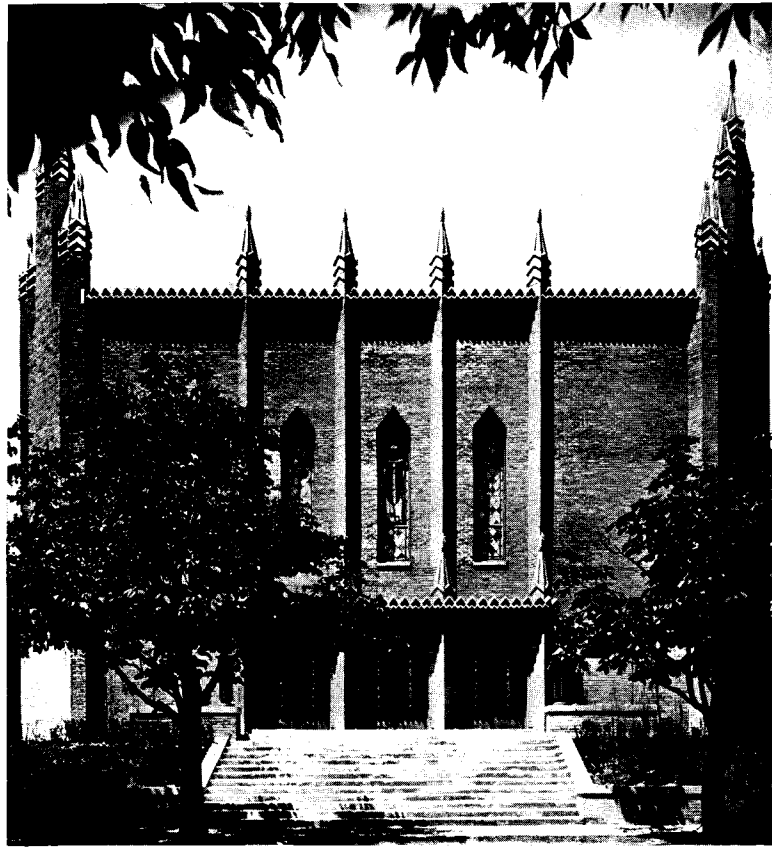
Portable air-conditioning unit developed for use in tropics.

TO "LIGHTEN the white man's burden" under tropical conditions, Newcon Industries, Limited, of London, are marketing the Rektifair, an air-conditioned cubicle. Approximately 6 ft. 4 in. by 10 ft. 3 in. by 7 ft. 2 in. high, this portable unit may be enlarged by adding interchangeable panels. Two persons can easily erect the unit in an hour, without use of tools. The panels are clipped together by means of simple fasteners already in position. The air-conditioning mechanism is attached to the outside of the cubicle. By isolating the conditioned air, the manufacturers claim to be able to use a mechanism with a consumption half that of an ordinary air conditioner—total consumption being approximately 700 watts. Because of the small size of the unit, it is only necessary for the Air Rectifier to operate intermittently.

Featuring this equipment as "a boon to the ladies," providing "absolute comfort during those unbearable hours when even the slightest occupation means exhaustion," the manufacturers call attention to its other features. The construction is a stiff, rigid, light metal frame. The materials are durable—entirely proof against ants, insect pests, rot, and warping. Insulated panels give protection against noise. Natural light is admitted through double-glazed windows. Electric and water services may be brought in through two special tubes.

The London School of Hygiene and Tropical Medicine has tested the apparatus and finds "that it will be of considerable benefit in maintaining the efficiency and health of those compelled to work under strenuous climatic conditions."

DESIGN TRENDS



1924: St. Lucy's reflected the changing world... pp. 76

ARCHITECTURAL
RECORD

RECENT TREND

by MAURICE LAVANOUX*



Monkmeyer

BAROQUE TO TRAILER:

The response of Catholic church design to the contemporary scene is apparent in Munich's baroque St. John Nepomuk (above), begun in 1733 by the Brothers Asam. Barry Byrne's 1924 decorative, non-structural envelope for the functional plan of St. Patrick's at Racine, Wis. (p. 75); Alfredo Martinez's recent fresco for Mary Star of the Sea at La Jolla, Cal. (center and p. 80), and St. Lucy's of Tennessee (right), one of the growing number of mobile chapels used by the Catholic Church for its mission work in rural areas.



Courtesy Dodd Meade & Co.



Sigurd-Fischer

NON-CATHOLIC CHURCH DESIGN IN AMERICA

SOMETIMES in the vanguard of architectural advance (as in the Gothic development of both structural and art forms) and sometimes lagging behind (as in the last century), church design has always occupied a special place in architectural history. In this study—first of a series of three covering contemporary church design in America—ARCHITECTURAL RECORD has asked Mr. Lavanoux to analyze recent progress in the Catholic Church; subsequent studies will analyze church design for the Jewish and Protestant faiths.

DURING THE EARLY DAYS of the Catholic Church in the United States, the missionaries were beset with problems of far more immediate importance than building design and artistic standards. They had to labor mightily to establish the Church in virgin soil and overcome physical handicaps which seem enormous and well-nigh impossible to us today. Those were heroic days, and no one with even a superficial knowledge of the ecclesiastical history of those times will wish to minimize in the slightest degree the achievements of those hardy pioneers. But the buildings that were erected at the time were often of the crudest sort and no pretense at architectural distinction was attempted.

As the Church became an established part of the American scene, and as American life itself became more stable, increased attention to building problems became possible. This stabilization was, of course, not evenly distributed either in time or space. In the Southwest, it was rather early—the San Diego Mission was founded in 1769; the Santa Barbara Mission in 1786; San Luis Obispo in 1772; San Gabriel Mission in 1771. In New Orleans, the present cathedral was begun in 1790, and Saint Louis saw its first cathedral in 1831; while along the Eastern Seaboard, the Church was well settled in large and substantial buildings by 1850. On the other hand, many areas in the United States—West Virginia, Kentucky, the Dakotas, Montana, etc. where the Catholic population is still small and scattered—almost reproduce former pioneer conditions even today.

Because of this unequal development, and because of varying cultural sources and local conditions, it was natural that the design of these church buildings should be varied both in form and content. But—after what might be termed the pioneer period in ecclesiastical art in the United States was over—there were not those advances in church design which might have been expected. European architectural experience undoubtedly influenced these early architects and led them to accept architectural precedents without sufficient understanding of the fundamental bases of those precedents. Ironically enough, this became more and more the case as the nineteenth century advanced. By the mid-century, the idiom of the Gothic Revival—of which St. Patrick's Cathedral in New York is perhaps the best example—dominated the scene.

The uncritical acceptance of much of this work can be laid at the door of the good old policy of *laissez-faire*, of ignorance, of indifference, and—too often—of downright opposition to social, economic, and technical advance. Without going into the highways and byways of the early ecclesiastical history of the United States, the reasons for this widespread disregard of architectural criteria are more or less apparent. We can nowadays more fruitfully consider the shabbiness of much of the work of the past decades as an example of what not to repeat in the future.

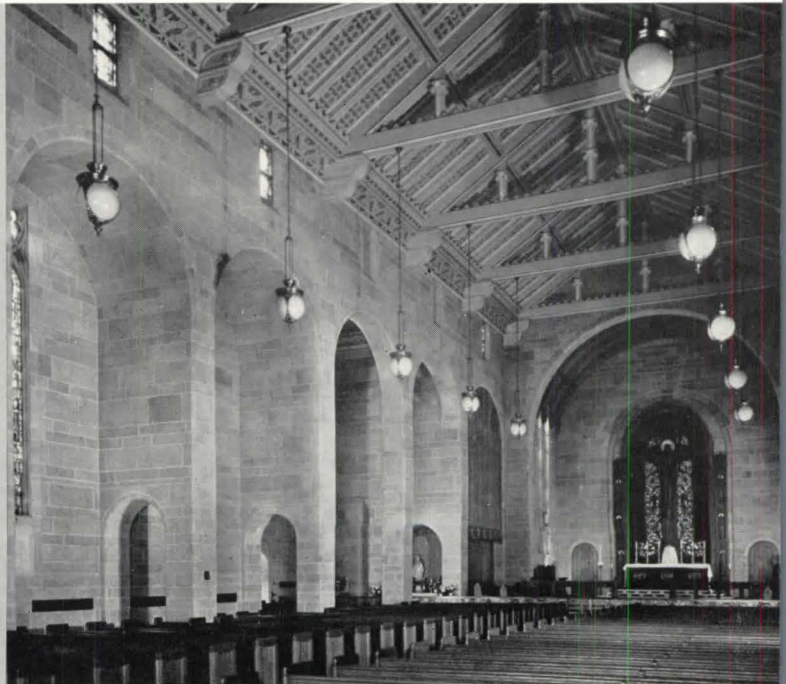
*Fifteen years' experience—first in the offices of various Catholic church architects and later as Secretary to the Catholic Liturgical Arts Society and Managing Editor of *Liturgical Arts*—makes Mr. Lavanoux a qualified spokesman on this subject.



Photos by Depue, Morgan & Co.



Saint Joseph's, Seattle, Wash. A. H. Albertson, Wilson and Richardson, architects. Gothic conception in reinforced concrete, treated in a colloquial manner common to the West Coast.



Saint Austin's, Minneapolis, Minn. Bard
Vanderbilt, architects. A develop-
ment of forms derived from the para-
bolic vault. The consistency of the total
design is somewhat impaired by a lack
of relationship of parts to the whole.

Co-Cathedral of Christ the King, At-
lanta, Ga. Henry D. Dagit and Sons,
architects. A scholarly example of the
best use of traditional architectural
forms. It may be noted that this build-
ing and Saint Ann's church, Hamilton,
Ohio, are substantially the same in plan
as Saint Austin's church. A develop-
ment of new architectural forms must
find its basis in the building plan.

Saint Ann's, Hamilton, Ohio. Edward
Schulte, architect. The same remarks
apply in this case as in those above. The
simplicity of the tower is a happy so-
lution to an otherwise difficult problem.

The needs of a corporate unity like the Catholic Church are manifold and complex, and its building needs attain large proportions, especially in a country as large as the United States. It is difficult to estimate the annual building operations of the Catholic Church in this country, but the amount is very large, particularly if we include in this all alterations, maintenance, and new work. It is therefore all the more important that any study of these buildings be fully understood in a clear-sighted and contemporary fashion.

Generally speaking, the dominant trends in American life are reflected in the building operations of the Catholic Church. It becomes increasingly important that these be understood since they play an important role in the design of Catholic churches. A complex, growing, and shifting population—particularly in urban centers—calls for increasingly accurate analysis of the specific needs of specific congregations. Is it urban, suburban, or rural? Is it large or small? Can it be expected to grow or will forces—population shifts, movements of industry, etc.—cause it to shift?

Next—and growing out of the above—there is the problem of cost. In the decade preceding the 1929 recession, it was customary to design and construct churches without too much regard for the budget. At any rate, the budget was a rather elastic proposition. Many a prelate in this country now bitterly rues the day when he was induced to build structures which now eat into the available resources (or rues the legacy handed down by his predecessor) to such an extent that mortgages can only be settled through astronomical banking arrangements, or when interest charges and current parish expenses can only be met with difficulty.

But, in another sense, the requirements of the Church in this country are what they have always been: the *best possible building*—structurally, aesthetically, economically—in which the Holy Sacrifice of the Mass can be celebrated with dignity and in full compliance with liturgical requirements. And it might be well to repeat here the obvious fact that the primary function of a Catholic church is to *shelter the altar and the congregation*, and not

that it be arbitrarily planned to suit the romantic notions of the architect or his client without due regard for the ceremonies that will eventually be performed in the building.

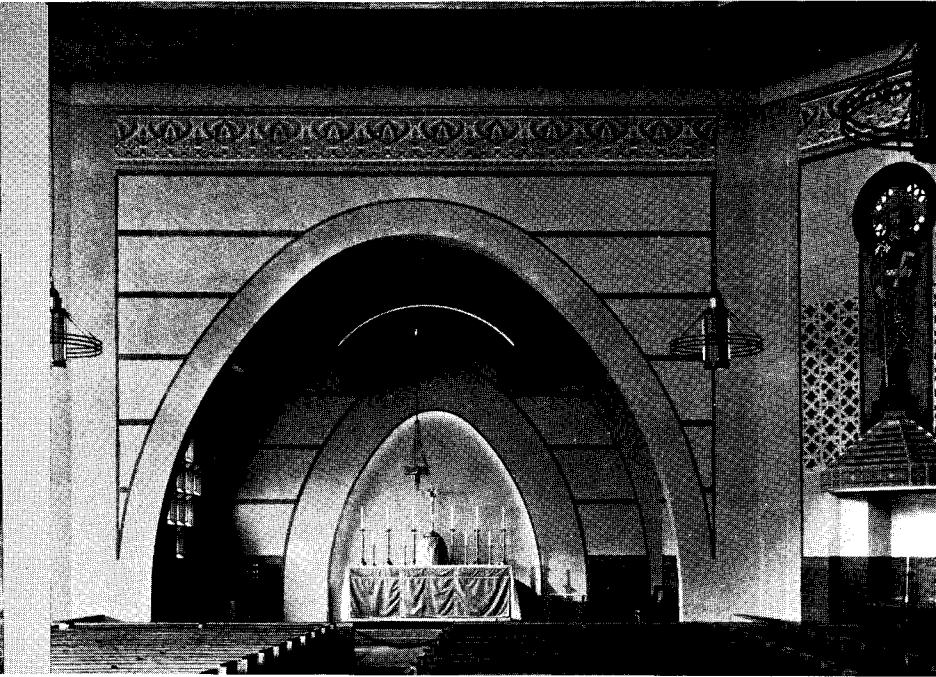
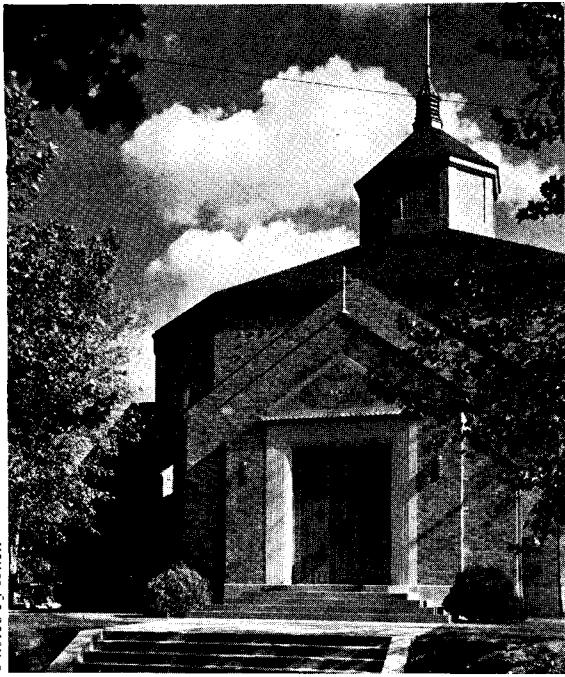
Although certain liturgical requirements remain fixed, they are simple and—contrary to popular belief—highly flexible. Within certain limitations, the design of altars allows for many interpretations; the location of the choir near the sanctuary, rather than in a gallery at the rear of the church, can well produce new and interesting plans; a decently planned baptistry, together with adequate space for the ushers, and possibly a small room for the diffusion of the aims of Catholic Action through the efficient and dignified sale of newspapers, pamphlets, and magazines—all these elements easily lend themselves to handling in a thoroughly contemporary fashion.

Since plan requirements are of a relatively simple nature, it is easy to conceive of many variations of plan from which can naturally flow a new interpretation of design thoroughly in harmony with the needs of the congregation and of the ceremonies that will be carried out in the church itself. And all this work should be done in strict accordance with what may be called the *mind* of the Church, i.e. honesty of purpose, honesty of material, honesty and fairness in the matter of compensation for honest work done by competent persons.

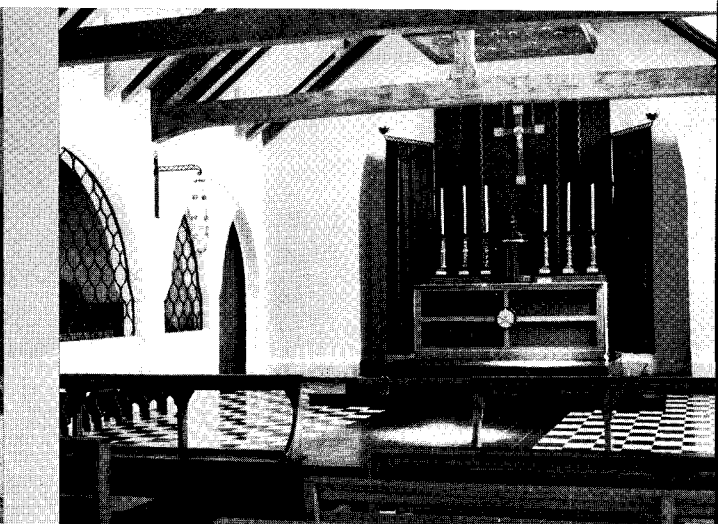
Recent decades have witnessed unparalleled development in the *technical means* of meeting these demands. Here lies the great opportunity for the designer—an opportunity of which Americans have not taken as full advantage as their European colleagues. And it is at least paradoxical that those standards of design and performance which govern the construction of all other buildings used by the Church—such as schools, hospitals, etc.—are so often ignored in the design of the churches themselves.

Anyone who has studied the church buildings of the past decades cannot fail to sense the fact that a romantic association with the shadow of past achievements has vitiated much of the work produced. Naturally there are exceptions—and the work of such eminent

Photos by K'nell



Photos by Frederick Burkett



PROGRESS IN SYSTEMS OF CONSTRUCTION

Trends in systems of construction are analyzable in terms of several leading criteria, described here as increasing flexibility, integration, and mobility. This survey, one of a series, is contributed by John E. Burchard, Director, and David Mayer, Research Assistant, of the Albert Farwell Bemis Foundation, Massachusetts Institute of Technology.

Thus the Exposition Hall at Brünn in Czecho-Slovakia, almost at the beginning of our decade, exhibited two concrete parabolic constructions by Kalous—constructions as yet unsurpassed in this period. At Germany's surprise exhibition at Düsseldorf, the roof system of the Hall of Siderurgy was made of steel corrugated plates forming six arcs of triangular cross section ending in patellae, one of which was mobile to allow for expansion. Since the building was not designed for permanence some of the problems were left unsolved, but the idea was none the less daring.

Paris, moreover, abounded in dramatic engineering suggestions. The fair itself had many structures which put to shame Le Corbusier's extramural tent based on the suspension principle. Inside the grounds one might see the Pavillon des Eaux et Forêts with its combination piers and cantilevers of laminated wood; the Palais de l'Aéronautique with its truncated parabolic dome ending on a compression ring; the Pavillon des Métaux with its tension ring construction; the passerelles at the Quai de la Conférence suspended from rigid frames of steel; the passerelles from the Pont de l'Alma made of laminated wood girders; and the amazing Czecho-Slovak pavilion with its four-point supports employing heavy steel cantilevers under the platform, and with its spectacular use of glass and concrete in the roof. Even Glasgow, which did not offer much of high significance, did show a curved cantilever concrete canopy used as the shell of the bandstand.

In the face of this spate of effort, American expositions seem tentative and are not good demonstrations of the abilities of American designers. The reasons may not be far to seek. If a fair is solely an architects' jag in which engineers are brought in only to make the framing for stage-sets, its buildings cannot be expected to display as much significance structurally as if engineers are made a part of the designing force. At Paris, despite the great interest in the decorative uses of new materials and a recognition of the possibilities in mod-

ern display technics, it was also recognized that the union of "Art and Technology" is the important thing. Hence, from the point of view of this study, Paris was significant; New York and San Francisco are not.

Flexibility

It is recognized with increasing force by people who theorize about buildings that it is desirable for usable space to be more flexible than in the past. Counterforces are at work, one group tending to make this possible, one to make it impossible. Advanced structural methods warranting greater spans, integrations of units to divide spaces on a temporary basis, increased mobility of accessory equipments point the way towards flexibility. Expanding numbers of services requiring increased numbers of service conditions, both within and without the building, tend to retard the trend to flexibility.

In the design of office buildings, the desirability of the flexible floor plan—flexibility in one plane—has long been recognized. Paul Nelson's proposed "Palais de la Découverte" recognized for museums the need for both horizontal and vertical flexibility, a recognition which, greeted with some skepticism by many at the time it was proposed, has now been given a sort of cachet of nobility by the recently published program for the Smithsonian Gallery of Art Commission competition. Universities, schools, medical centers, even industrial plants have more often than not found themselves circumscribed by the rigor of the nonflexible plan. The designer of today, designing for tomorrow, must take advantage of modern technics to attain flexibility so far as this is possible with modern technics; and where it is not, technics will presumably go forward.

Integration

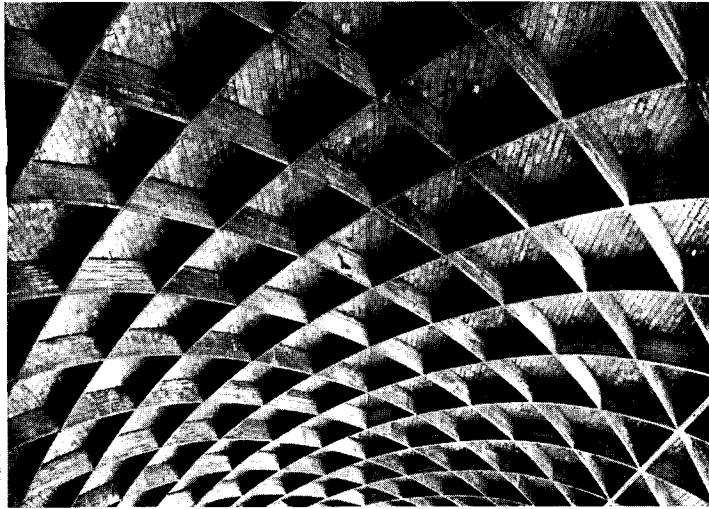
As soon as man stopped making his buildings all of one material he began the history of integration, but until recently this integration has been one on the site. Meanwhile, materials have been integrated in factories into many objects, and the contemporary trend

well advanced is toward integration of parts into wholes. There is also a well-defined trend towards integration of mechanisms into machines, towards integration of the services performed by various machines into one machine; well defined is the tendency towards integration of the community itself, and more recent and less clear is a further trend toward integration of regions. In so far as these integrations provide pre-built walls, floors, or mobile equipment units, they tend to support the trend towards flexibility. In so far as they tend to tie the building more closely to services provided by the community, they tend to arrest it.

Mobility

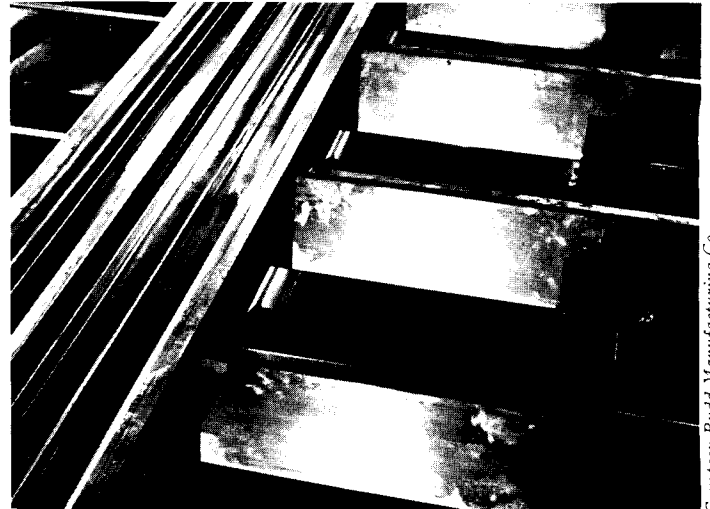
More controversial is the assumed trend towards increased mobility. Obvious are the beginnings of developments in mobile heating and lighting equipments. Even more obvious, perhaps too obvious, are the achievements in the field of the trailer in which it has been possible to provide not only mobile shelter units, but also mobile stores, dentists' offices, and churches. To conclude that every one will therefore take to the road involves economic and sociological considerations which have no place here. But it must be remarked that the trailer manifestation constitutes a maximum of integration, and therefore an acceleration of the integration trend and a minimum of flexibility qua the structure involved, because the compactness of planning negates flexibility inside the planned unit. That it provides flexibility for the individual concerned is undoubted. But mobility also raises problems too great to be solved by technical integration alone. Though conceivably heat, light, and sewage-disposal problems may be solved within the chassis, the greater ones of water supply, of schooling, of medical care, of policing, seem beyond the province of engineering technics.

To each of these trends contributions have been made from two major fields, structural design and equipment design. Each of these fields has concerned itself with a wide variety of materials.



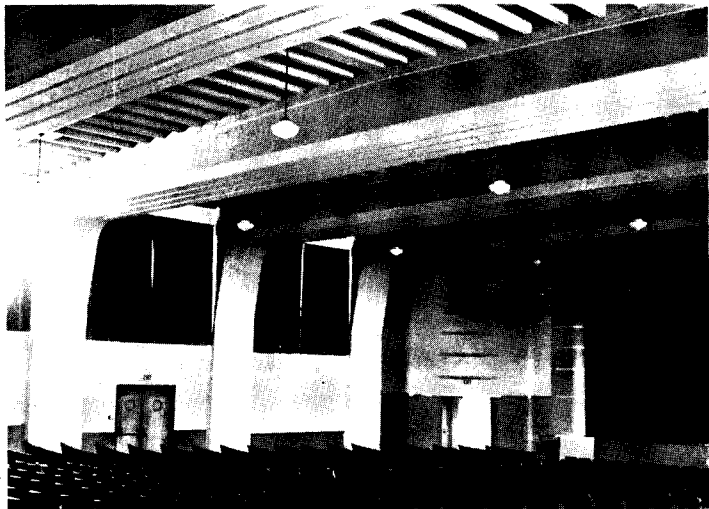
Pasori

Lamella-type constructions in concrete, steel, and wood permit wider spans and flexibility of enclosed space. . . .



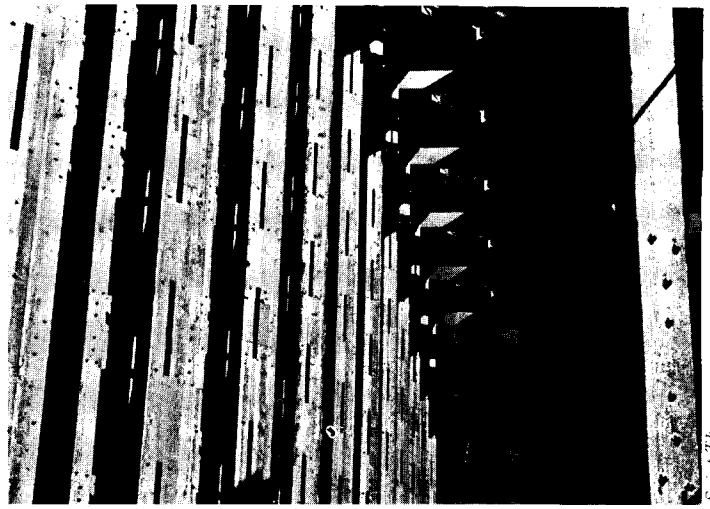
Courtesy Budd Manufacturing Co.

Use of welding and alloy steels allows savings in weight and increased continuity of structure. . . .



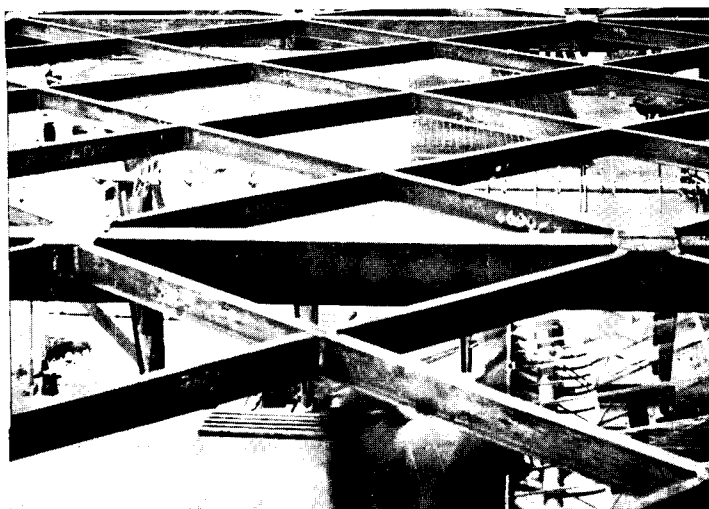
Wright, Engineer

Rigid-frame construction in concrete, combined with the use of hollow girders, reduces dead load. . . .

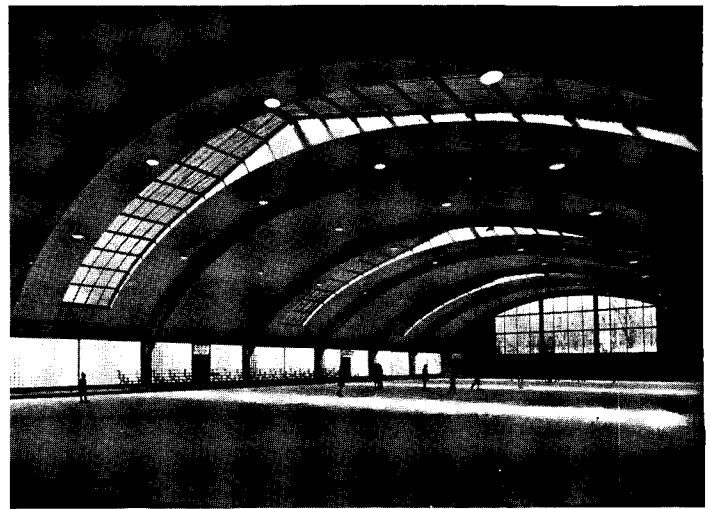


Stant Thomas

Development of metal connectors makes possible the increased structural use of small-dimensioned wood members. . . .



Development of welded steel grids allows spanning of wide spaces with no bracing below the roof plane. . . .



Concrete-shell systems, like the Z-D construction, make possible important savings in weight and material. . . .

STRUCTURE Thus the general acceptance of statically indeterminate structures has opened wide vistas for the exponents of flexibility. Rigid bents and frames have in the past decade come into their own, whether they be of steel, through the medium of welding (Lincoln Electric Company's new building at Cleveland which has no horizontal trusses), of wood (Hall of Progress, Cleveland), or more frequently of concrete (countless examples, including Exposition Hall at Brünn). Concrete offered the basis for the earliest rigid frames because of its relative homogeneity, but something approaching that homogeneity has now been made possible in steel through welding, and in wood through the new resin glues. Indeed, in the Hall of Progress coated nails were used in the field erection of rigid frames as controlled gluing was impossible on the site, but had it not been for controlled gluing of plywood, this would have been impossible. Rigid frames have now reached a stage of general acceptance to which many highway bridges and New York's West Side Highway bear witness. Welding and low-alloy steel are today in about the position occupied by rigid frames ten years ago.

A further application of steel which has not been fully applied to building construction is based on the suspension principle. It has been hinted at in the Transport Building at Chicago, and in Le Corbusier's tent at Paris, but perhaps most interestingly in the projected construction of Breines which finally was not built at the New York Fair. This, it will be recalled, was a self-anchored suspension system based on a compression ring to take up components of cable stress. In view of the extraordinary strengths of drawn wires of alloy steels of the 18-8 type (Budd exhibit at New York Fair), it is evident that the possibilities of long spans for buildings have not been exhausted.

Another engineering device which tends to free space is the cantilever. By the application of rigid-frame principles, cantilevers now extend to fantastic spans. They have been demonstrated recently in the Czech pavilion at Paris and are well known in Finnish and, in general, in European work, most commonly in concrete but also in steel.

Several developments in timber construction have also played their part in this potential freeing of space. Not especially new are timber connectors, which were developed in Europe during the period 1916-1922, with such notable

examples as the hangar at Spitzbergen for Amundsen and the 330-foot radio tower at Muhlacher Station in Germany. Only recently have these connectors awakened serious interest here, and then principally in the field of semi-permanent highway bridges. But it is not too much to say that they open the field again to heavy-duty timber construction and on longer spans, particularly if they are combined with plywood and with other contributions of the timber art, such as Lamella construction and heavy laminated structural members.

Improved technics of making concrete have led to reliance on the material for greater spans and for more daring achievements, but here, again, for bold engineering we must turn to such European masters as Maillart or to European designs such as the thin shell which in planetaria, gymnasias, and other large structures has already gained substantial vogue (Z-D system).

Of less value in the freeing of space are the possibilities in reinforced brickwork and glass-concrete. Reinforced brick has been known for some time. A recent contribution is furnished by the Vermont Avenue School in Los Angeles which was designed to meet the state seismic laws. The floors of reinforced concrete are designed as horizontal girders to carry forces to the transverse walls which, designed as vertical cantilevers, carry the lateral forces to the ground, while the longitudinal walls are designed as vertical beams for transverse horizontal forces. Glass-concrete, though an interesting engineering development, seems to lack the strength of either material alone and is, perhaps, principally important not as a new structural contribution but for the opportunities it presents for new uses of light. (See AR, 2/39, pp. 65-72)

Glass alone is a fascinating material to conjure with as indeed are some of the less popular silicates. Glass block seems well established, and the joint problem is more satisfactorily handled than it was in earlier years. Except for its light-transmitting characteristics, however, the glass-block wall is a masonry wall and in itself makes little contribution to any of the major trends under discussion. Glass has remarkable structural properties if these can be put to work, and the last word may well not have been written, but its low shock resistance and the high cost of tempering it in preformed shapes to eliminate this, plus the fact that it is not altogether a stable material, lead one to rate its

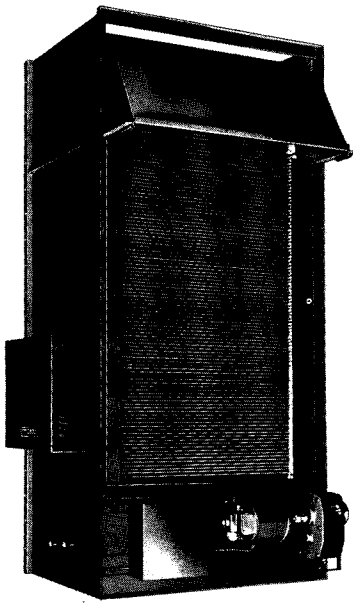
structural position as low, over the next decade at least.

It is evident, then, that the freeing of space has largely been made possible through the development of precision control of concrete, through the development of welding of steel to the point where it has received the final symbol of approval (recognition by New York City Building Code), and through the development of synthetic-resin glues which, though not quite so definitely proved as the others, none the less enjoy a favorable weight of expert opinion. Collateral developments are the decorative use of concrete (Earley mosaic concrete; plywood forms); the low-alloy, high-strength steels; the possibilities of metal spandrels, often of the light metals (aluminum and less certainly magnesium and beryllium; note also first handbook of structural aluminum published in the United States in 1930); and the necessary combinations of these with older established materials which use of the newer ones implies. But it is precisely the technics of welding and gluing with thermosetting compounds which have made possible the integrations which must accompany the freeing of space in order to permit the trend towards flexibility to continue.

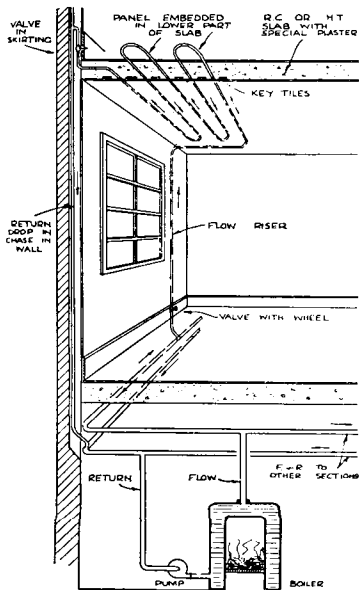
Finally integrations of the structural shell itself have already begun to appear, having as the desirable ends to be attained not flexibility but ease of production and erection. In the small-house field there are many among which it might be invidious to choose. A very old one exists in the wood-frame field (Hodgson), while another (Gunnison) takes advantage of modern plywood and modern gluing, and a third (Homasote) of complete modularization. Integrations for larger buildings are less common, but there are examples, particularly in Europe in the controversial work of Mopin (Drancy and Leeds). The most complete of these integrations occur in the trailer, whether of standard type (Covered Wagon), of the unfolding house type (Stout), or the two-story mobile type (Willson); so fully have these efforts attained their ends that ease of erection need no longer be considered, field erection problems having been eliminated. More faith may perhaps be placed in those who would combine the integration of the trailer with some construction on the site, to produce an assembly of trailers which resembles a full-sized dwelling (Blouke, Carpenter, Stoddard).



The fluorescent tube is several times more efficient than the incandescent filament. Here it is built into a two-story glass-block wall.



Greater precision in control of environment implies specialization of equipment. Example: automatic air filter.



Radiant heating, in which pipes are embedded in ceiling, wall, or floor, raises new problems of integration.

EQUIPMENT

The use of office partitions has long been known as a method of subdividing in a controlled manner raw space which is subject to changing use. A very recent development along these lines, with the necessary further contributions of an integrated bathroom and an integrated kitchen, has been announced by Sneed and Company, permitting a similar technique to be applied to apartments. Such integrations can reach their highest development only through the adoption of standard designs with accuracy of dimensions implied in the manufacturing operations.

All such integrations imply the adoption of a module, and a module has, in fact, generally been adopted by each person who has proposed an integration, but it has remained for a more recent effort to seek the adoption of a common or universal module. Studies are now being pursued by the American Standards Association's Committee A-62 on the "Co-ordination of Dimensions of Building Materials and Equipment", under the joint sponsorship of the American Institute of Architects and the Producers' Council. In advance of adoption of any universal module some notable individual integrations have been made. Kitchens and bathrooms with the walls as part of the assembly (Sakier for American Radiator), pressed steel bathroom fixtures (Briggs), partitions which are much thicker than usual but which, hollow, provide universal storage or other space (Sneed), are all cases in point. An unmarketed symbol of further integration is the Fuller bathroom (Phelps-Dodge). This bathroom, it may be recalled, weighs 450 lbs. against a normal 2,000 lbs.; its copper and copper-alloy rough plumbing manifold is a prefabricated and bracketed assembly of all hot and cold and waste lines with but few final connections. Integrations of this magnitude must be prepared, it goes without saying, to meet opposition similar to those resistances which have previously been met by other proposals for technological advance. Thus a few years ago the very sensible welded plumbing stack developed by Ingleside met with substantial opposition from plumbers.

Flexibility requires further that equipment be flexible. Some steps have been made in this direction. Thus unit heaters (integrations of heating elements

and fans or blowers) may or may not be freestanding and have invaded the field of gymnasias and churches from the field of industrial buildings. Rapid progress in reducing the sound level of these devices begins to make them look promising for residential work as well, where they would provide flexibility of heating in different rooms. Continuous outlets in base molds, though subject to the danger of overloading, nonetheless provide a sort of flexibility of electrical distribution which is also provided by the alternative trolley base mold. The biggest handicap to complete flexibility of equipment lies in supply pipes, conduits, and the like, and their elimination must depend on developments not yet made but not at all impossible in the light of present scientific knowledge.

Other important developments in technics which cannot be ignored in consideration of this problem include the unquestionable advent of radiant heating (note large example in Douglas Aircraft hangar at Santa Monica); the control of solar radiation for temperature and light (Venetian blinds, metal awnings, glass window shades); the advances made by radiant insulators (Alfol, Rubatex, aluminum paint, Ferro-Therm); the great promise of cheaper, better artificial illumination through the use of fluorescent lighting; the serious consideration which must be given to vapor seals; the advance of sound-control technique; and such improvements in efficiency of old devices as may be represented by the Aga stove.

Further implications

Finally, one further question may be posed. It took a New England hurricane to make one section of the country realize how precarious is the position of society when its communications are even temporarily broken down. Private stand-by power plants now seem indispensable for any hospital or other institution which must carry on, come what may. To what degree will the future apply these considerations to the dwelling as well? The difficulty with autonomy for the detached house today is largely one of cost. But it is not only the brooding threat of war from the air which will lead the thoughtful citizen to fear the intimate physical connections which now bind him to the womb of society.

Current Trends of Building Costs

Compiled by Clyde Shute, Manager, Statistical and Research Division, F. W. Dodge Corporation, from data collected by E. H. Boeckh & Associates, Inc.

CURVES INDICATE trend of the combined material and labor costs in the field of residential frame construction. The base line, 100, represents the U. S. average for 1926-1929 for residential frame construction.

Tabular information gives cost index numbers for the nine common classes of construction. The base, 100, in each of the nine classes represents the U. S. average for 1926-1929 for each particular group. The tables show the index numbers for the month for

both this year and last.

Cost comparisons, as percentage differences for any particular class of construction, are possible between localities or periods within the same city by a simple process of dividing the difference between the two index numbers by one of them. For example: if index for city A is 110 and index for city B is 95 (both indexes for A and B must be for the same class of construction), then costs in A are approximately 16% higher than in

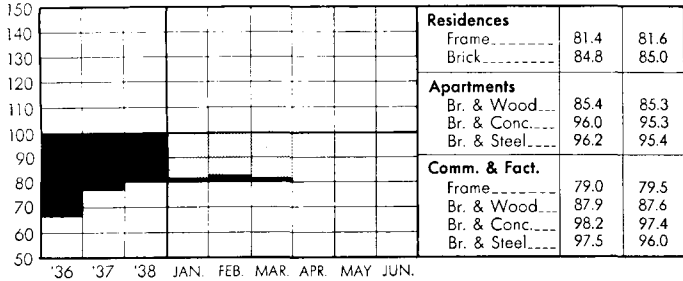
$B \left(\frac{110-95}{95} = 0.158. \right)$ Conversely it may be said that costs in B are approximately 14% lower than in

$A \left(\frac{110-95}{110} = 0.136. \right)$

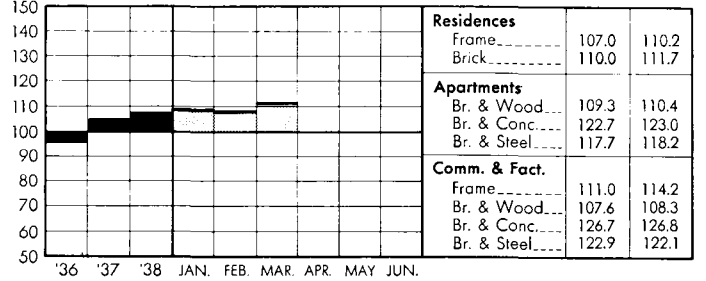
Similar cost comparisons, however, cannot be made between different classes of construction since the index numbers for each class of construction relate to a different U. S. average for 1926-1929.

CONSTRUCTION COST INDEX U. S. average, including materials and labor, for 1926 - 1929 equals 100.

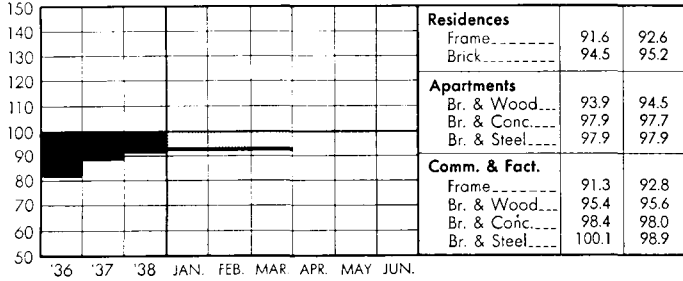
ATLANTA



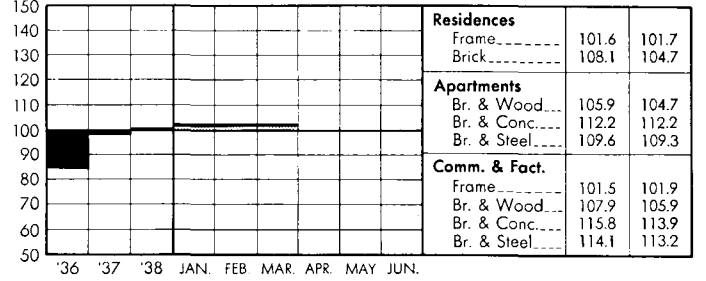
CHICAGO



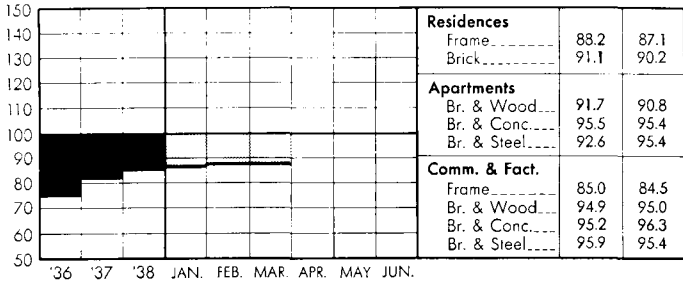
BALTIMORE



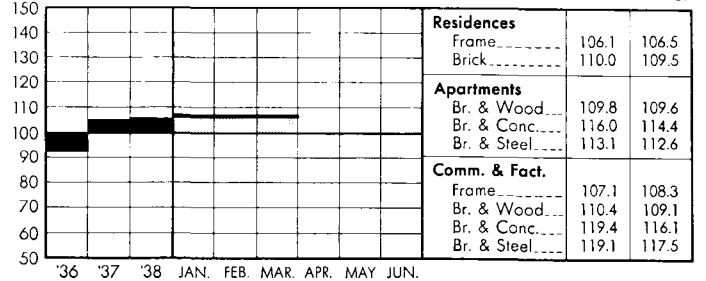
CINCINNATI



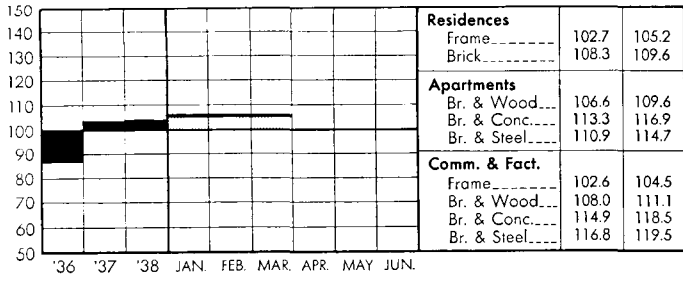
BIRMINGHAM



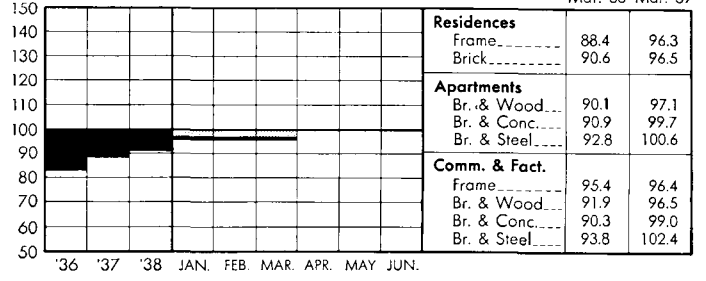
CLEVELAND



BOSTON

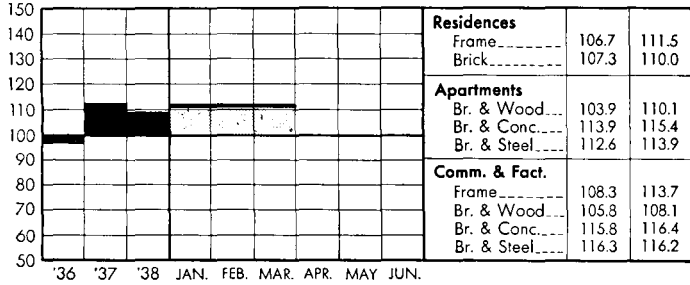


DALLAS



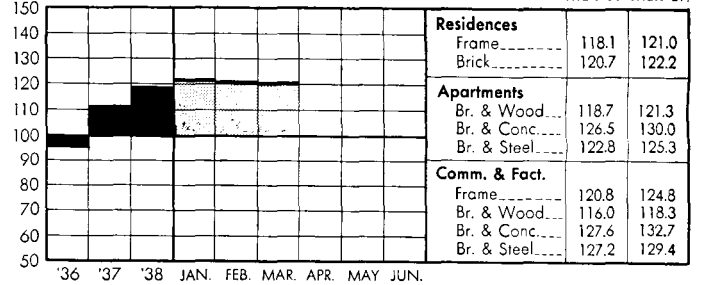
DENVER

Mar. '38 Mar. '39



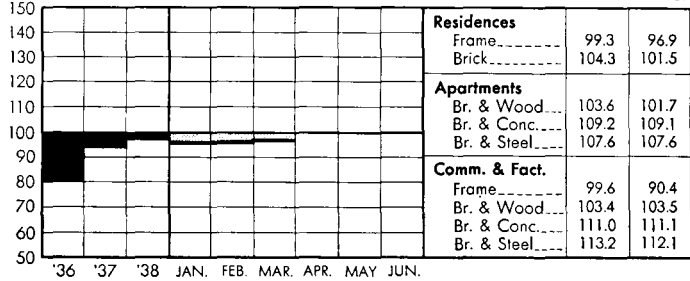
NEW YORK

Mar. '38 Mar. '39



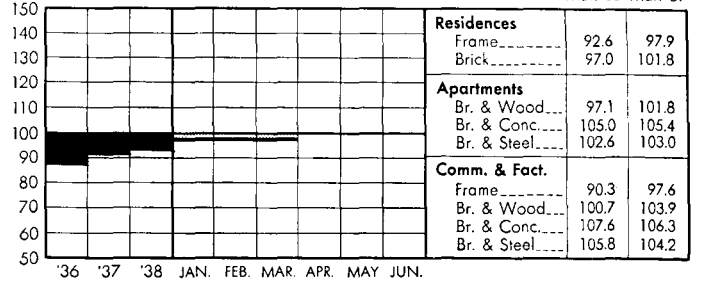
DETROIT

Mar. '38 Mar. '39



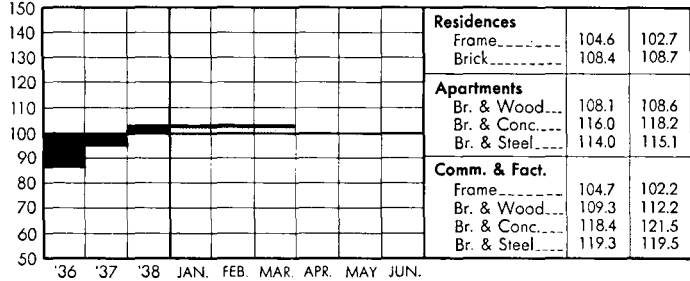
PHILADELPHIA

Mar. '38 Mar. '39



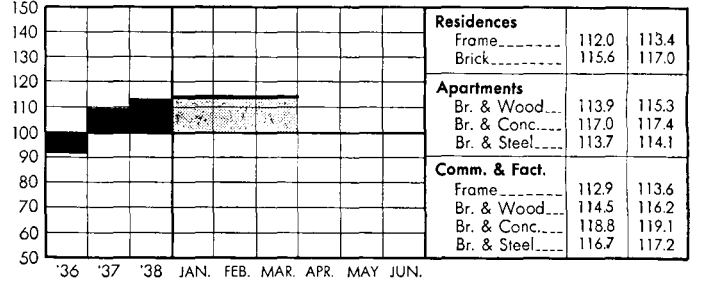
KANSAS CITY

Mar. '38 Mar. '39



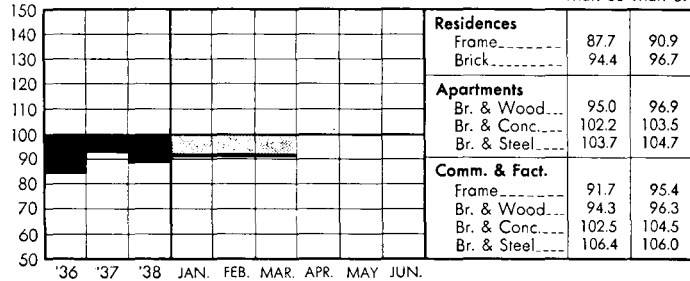
PITTSBURGH

Mar. '38 Mar. '39



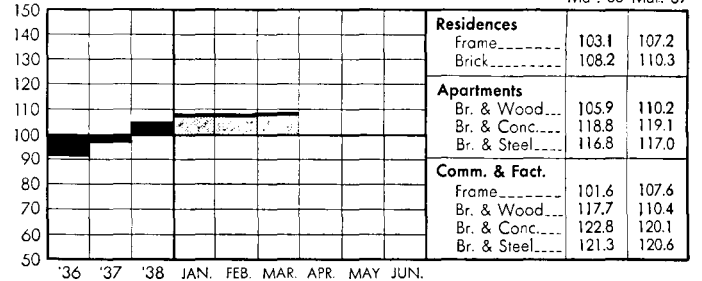
LOS ANGELES

Mar. '38 Mar. '39



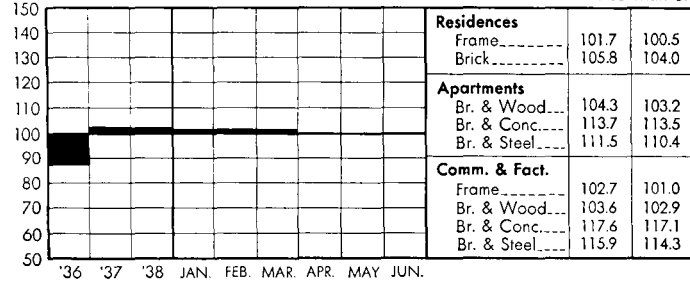
ST. LOUIS

Mar. '38 Mar. '39



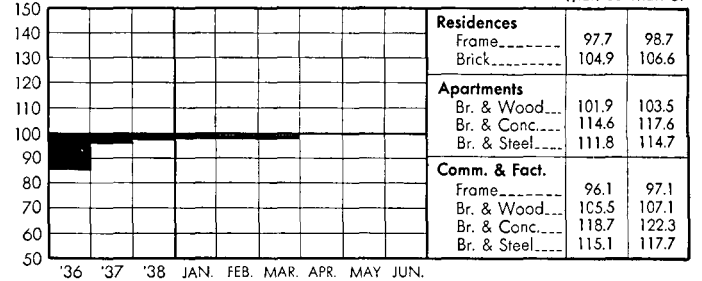
MINNEAPOLIS

Mar. '38 Mar. '39



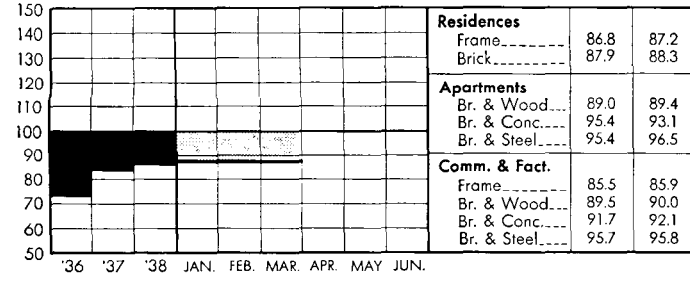
SAN FRANCISCO

Mar. '38 Mar. '39



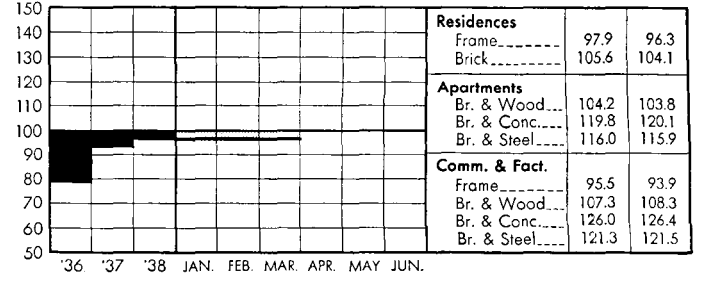
NEW ORLEANS

Mar. '38 Mar. '39



SEATTLE

Mar. '38 Mar. '39



Notes on New Books

DECORATIVE ART 1939, The Studio Year Book, edited by C. G. Holme. The Studio Ltd., London; The Studio Publications, Inc., New York. 168 pp. (including advertising supplement). 8 x 11½. \$3.50 (paper); \$4.50 (cloth).

THE STUDIO Year Book for 1939 contains about 500 photographic reproductions and plans, each illustrating aspects and details of home planning, building, decorating, and furnishing, with new designs in pottery, glass, metal, and fabrics. The material collected is representative both of America and abroad.

INDUSTRIAL ARCHITECTURE of Albert Kahn, Inc., by George Nelson. Architectural Book Publishing Co., Inc., New York. 176 pp. 9¼ x 12 in. \$6.00

THIS COLLECTION of photographs with explanatory text is an attempt to substantiate and exemplify by means of the industrial structures designed by Albert Kahn, the thesis stated by Mr. Nelson in his introduction: "Because these buildings are completely functional they are beautiful as a good machine is beautiful. And because they so clearly express the character of our time they represent its best architecture."

THE KEY TO YOUR NEW HOME by Lewis Storrs, Jr. A source book of ideas for houses, interiors, gardens, with architects' house plans. Stackpole Sons, New York. 128 pages of text, pictures, and plans. 9¼ x 13 in. \$3.00

ADDRESSING himself to prospective home builders and owners contemplating home remodeling, Mr. Storrs ranges from early American architectural styles to complete modernism in presenting ideas for various gradations of income. With practical livability his dedicatory principle, the author not only considers houses by means of pictures, text, and

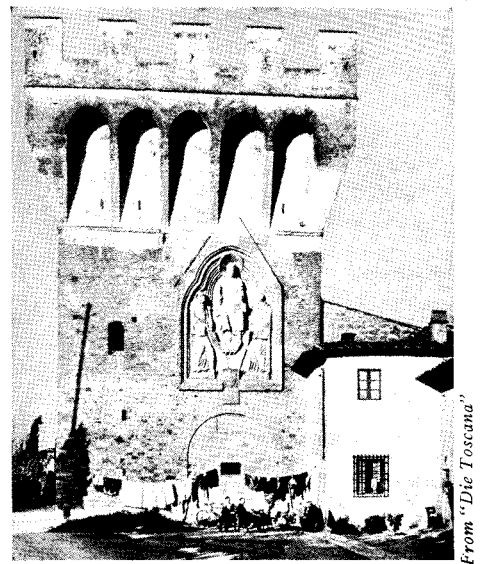
architects' plans, but many of their details as well, including doors and windows, driveways and swimming pools. He attempts throughout to point the way to get the most out of every budget.

MONUMENT TO COLOR, by Faber Birren. McFarlane, Warde, McFarlane, New York. 97 pp. with a supplement of 16 color plates, 9¼ x 12¼ in. \$15.00

IN THIS treatment of color from the standpoint of the psychologist rather than the physicist, Mr. Birren emphasizes its human nature in terms of sensation and emotion, rather than its physical attributes as a scientific study of the quality and intensity of its wave energy. He feels that the physicist sets color apart from life. While not disparaging the work of the pure scientist, the author does not believe that artists and colorists should base their gospels too much on the physicist's findings. In his introductions to the book, Mr. Birren says: "It represents a devout effort to produce unique color effects and to work with color as a vital rather than an electric art." In the first section he interprets the findings of the psychologist and describes the "new art" in everyday language; in the second he discusses abstract color for its own sake; and he devotes the third to color in the fine art of painting.

THE BEAUTIFUL NECESSITY, Seven Essays on Theosophy and Architecture (Fourth Edition), by Claude Bragdon, F.A.I.A. Alfred A. Knopf, New York. 111 pp. 7 x 9¼ in. \$2.50

THIS is the fourth reprint of Mr. Bragdon's presentation of the laws which, in his opinion, are immutable and to which every worker in the arts of design must submit.



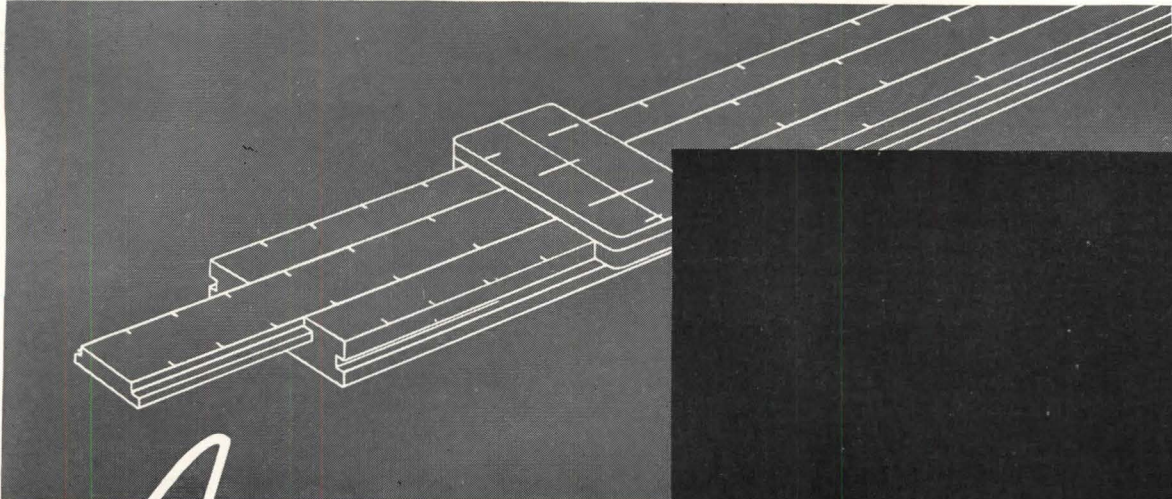
DIE TOSCANA; Landschaft, Kunst, und Leben im Bild, by Arnold von Borsig. Introductory text and explanations by Ranuccio Bianchi-Bandinelli. Anton Schroll & Co., Vienna. 54 pages of text, 224 pages of photographs, and one map. 9 x 12 in.

THIS VOLUME with its 251 photographs by the author constitutes a photo-travel through Tuscany. Von Borsig, paying more attention to the living aspects of the country than to the standard masterpieces starred in Baedeker's, has arranged his illustrations in the order in which their subject matter engages the attention of the discriminating traveler. Next to a view of the countryside, he often places a photograph of the details on a building located in the vicinity, intending to effect a correlation between the two.

The text and the explanations by Ranuccio Bianchi-Bandinelli, a "native" of Tuscany, provide a historical background for the photographic content.

YOU CAN DESIGN, by Winold Reiss and Albert Charles Schweizer. Whiteley House, the McGraw-Hill Book Co., Inc., New York. 119 pp., 90 illustrations, including 67 full page plates (12 in color). 9½ x 12¼ in. \$3.75

THE AUTHORS start with random scrawls and lead the reader from simple abstract designs to flower, bird, and animal patterns. Combinations of motifs are progressively treated from black-and-white, through various grays, to color. The method, intended to teach creative design, regardless of whether or not the reader has previous knowledge of art, has been employed by the authors for several years in group instruction.

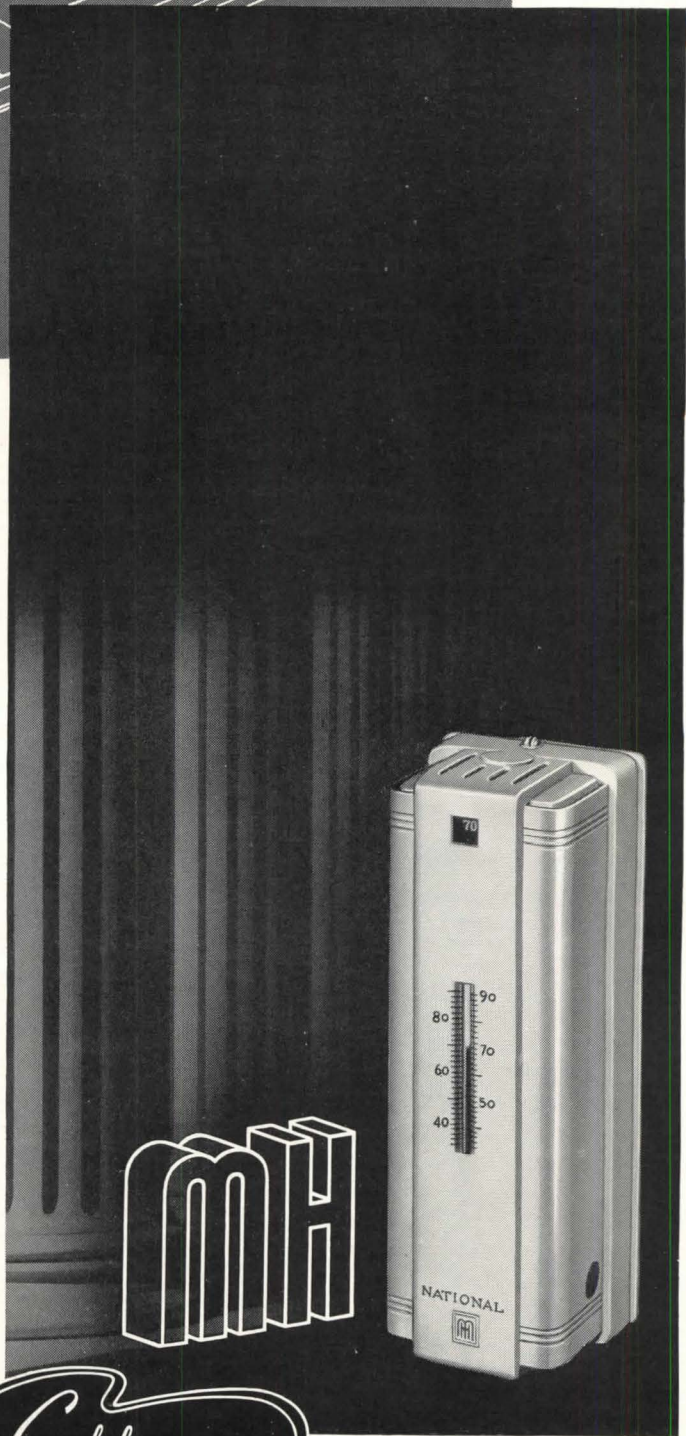


*A new standard
of Accuracy in*
**PNEUMATIC
CONTROL**

*M*INNEAPOLIS-HONEYWELL engineers have developed in the Gradutrol System a method of control for valves and dampers which positively guarantees infinite positioning. Valves and dampers assume exactly the position necessary to meet the demands of the thermostat.

This new standard of accuracy applies to all units of a Gradutrol installation, from the famous Gradutrol Helmet Seal thermostat to the compressor. Although Gradutrol installations are noted for their service-free dependability, M-H Gradutrol Service is nationwide.

With all its advantages over conventional pneumatic control, the Gradutrol System is available at no extra cost. Comparison is cordially invited. Minneapolis-Honeywell Regulator Company, 2804 Fourth Avenue South . . . Minneapolis, Minnesota.



THE *Symbol* OF THE NEW
AUTOMATIC HEATING

MINNEAPOLIS-HONEYWELL

Gradutrol System
... OF PNEUMATIC CONTROL

BUILDING TYPES



Piacet

Time-Saver Standards Data on RETAIL STORES

FORTHCOMING ISSUES: 1939 — May, Houses; June, Factories; July, Houses; August, High Schools; September, Apartment Houses; October, Theaters.
PRECEDING ISSUES: 1939-1938 — March, Housing Developments; February, Elementary Schools; January, Restaurants; December, Office Buildings; November, Houses (\$25,000 and Up); October, Houses (\$15,000-\$25,000)

ARCHITECTURAL
RECORD

DESIGN STANDARDS for



John Erwin

DESIGN STANDARDS FOR RETAIL SPECIALTY SHOPS.. 94-105

- Selling Areas 95- 99
- Display Areas—within the
shop 100-101
- Display Areas—show win-
dows 102-103
- Non-selling or Service
Areas 104-105

TYPES OF RETAIL SPECIALTY

- SHOPS..... 106-120
 - Women's Wear shops... 106-109
 - Men's Wear shops..... 110-113
 - Book shops..... 114-115
 - Gift shops 116-117
 - Jewelry shops 118-119
 - Florist shops..... 120

SPECIALTY SHOPS, for the purposes of this study, include those relatively small stores whose range of merchandise is limited to a fairly distinct field: women's wear, jewelry, books, flowers, and the whole class of objects loosely known as gifts, are familiar types of specialty shop merchandise.

Most of the data and sketches in the study were obtained by Frederic Arden Pawley. His sources include numerous architects and designers practicing in the field, and are also based upon extensive first-hand research into the requirements and opinions of shop owners. Information was obtained from Telchin and Gina; Winold Reiss and Albert Charles Schweizer; Dawson and Oliver; John Matthews Hatton, who designed the Peck and Peck shop illustrated above; and Poily Pettit, among architects and designers: and from Mrs. Petri of Pitt Petri, Inc.; the Gordon Waldron Shop; Kenneth I. Van Cott of Marcus and Company; and The Cotton Shop.

Principles of Retail Shop Design

IN ORDER TO DESIGN satisfactory shops, the first requirement is an understanding of those portions of current merchandising theories which affect the design problem. Briefly, "merchandising psychology" consists of, first, arousing interest; second, satisfying it.

With staple goods the first phase is almost automatic. When non-staples, accessories, or specialties other than "demand" goods are to be sold, methods of arousing interest may become more complex.

The second phase—the actual sale—involves factors of convenience which are desirable in order to make buying easy, to satisfy customers completely, and to achieve economy of space and time for the store management.

Both phases affect the design of retail shops, and are closely interrelated. In some cases the planning problems involved cannot be segregated. A more detailed listing of steps in the merchandising process, as they affect shop design, follows:

Attracting customers, by means of advertising, prices, show-window displays, or new or remodeled quarters, occupies much of a merchant's efforts. Of these, store fronts and display windows are important to the building designer.

Inducing entrance: Show windows, in addition to attracting passers-by, should induce them to enter the store. Show windows may be opened up to display the shop's interior; or closed in, to give privacy to customers within. Door locations require study in relation to: pedestrian traffic flow; grades of side-

walks and store floors; and interior layout of the shop. In colder climates drafts and outdoor temperature changes can be controlled at the door.

Organizing store spaces, and consequently the merchandise to be sold, into departments, enables customers to find objects easily, and permits storekeepers to keep close check on profits or losses from various types of goods. Store lighting and "dressing" are simplified. Even small shops benefit from a measure of departmentalization; in large shops, the practice becomes essential as methods of training salespeople, of handling, controlling, and wrapping stock, becomes more complex.

Interior displays require particular attention in specialty shops. Types range from displays of staple goods which assist customers in selection, to displays of accessories which the sale of staples may suggest to the customer. Problems of arrangement with regard to merchandise, departments, and routes of customers' approach are involved.

Relief from the repeated impact of merchandise sales efforts and displays is necessary in most shops. Experienced salespeople can tell at a glance the customer who is satiated with shopping and too bewildered to buy. After he has been refreshed by a brief rest, the customer's interest can be recaptured quickly. Such relaxation may be mental or physical, or both.

Conveniences intended primarily for the customers' benefit, while not strictly al-

lied to the problems of attracting trade or selling goods, are necessary to some types of shops. A florist, for instance, provides a card-writing desk or counter in his shop. In other shop types, particularly those whose prices are above the average, such extra provisions are often highly desirable. Conveniences of this kind include: telephone booths, drinking fountains, laboratories or powder rooms, desks for writing cards or checks, stools or chairs at counters or in special sales rooms, vanity tables or triplicate mirrors for certain types of apparel, fitting rooms.

In regard to finishes and equipment systems, the idea may be extended to include: floor surfacing for comfort; acoustic treatment of ceilings and possibly walls; illumination of pleasant, sometimes special, quality; and air conditioning. All of these have been found profitable investments in various cases. Their necessity or desirability depends to an extent on the type of shop, its location, or the climate of the locality.

INTERIOR LAYOUT: Selling Areas

Departmentalization: Benefits to be derived from segregation of merchandise by types have been touched upon previously. All of these are factors in decreasing the average time per sale, an important figure in large-store accounting and in small stores with rush periods.

Within each department, and as a guide when relating departments to each other and to the path of the typical customer through the store, merchandise

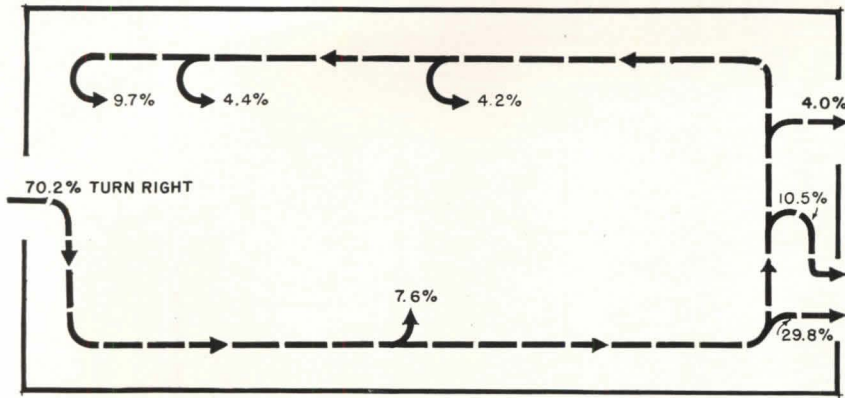
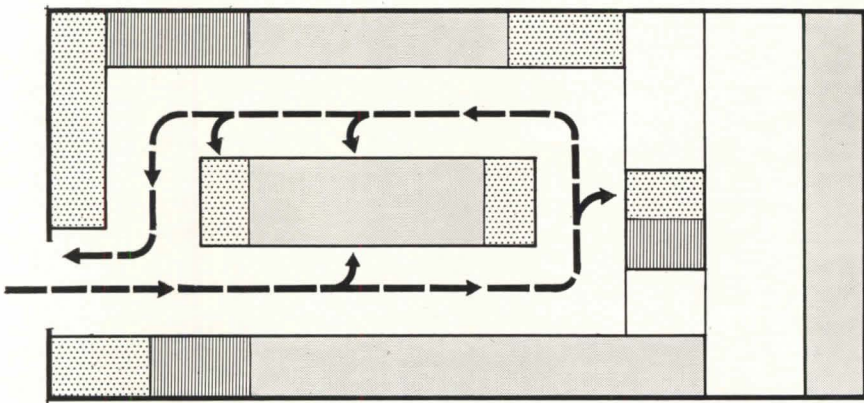


Diagram of patronage flow through typical museums and art galleries, developed from studies by Arthur W. Melton and Prof. E. S. Robinson of Yale University. Notice that by far the greater proportion of visitors turn to the right at the first opportunity. Other findings: wide aisles attract more persons than narrow ones; doorways or narrow openings attract people to exhibits; too much display fatigues the viewer.



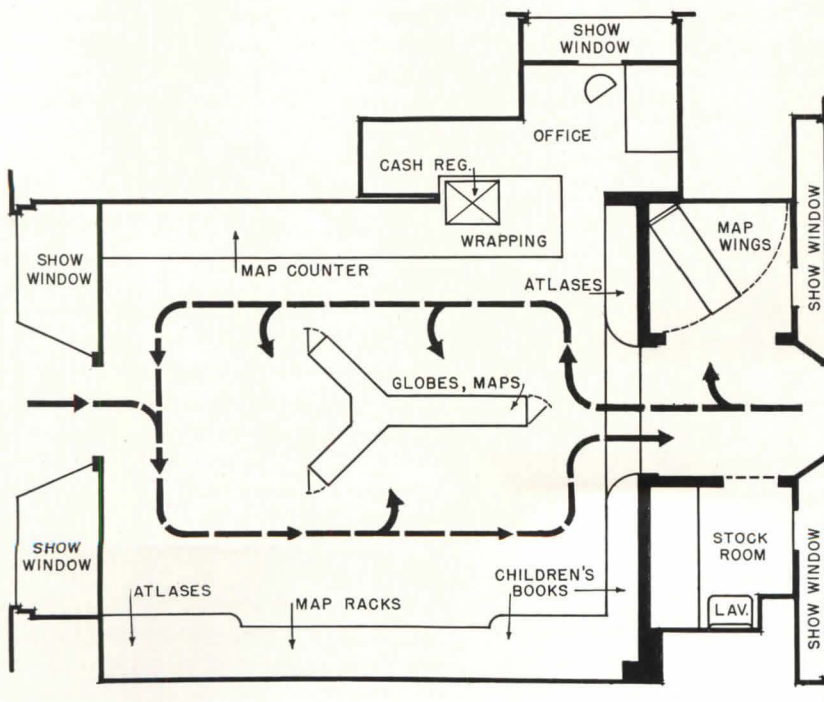
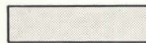
The principles developed above are here applied to shop design, and merchandise is located according to classification: staple goods are unobtrusively yet accessibly placed; luxury items are spotted where the prospective customer cannot help but be attracted to them. White counter areas are allocated to services: cashier, wrapper, information, etc.

LEGEND:

Demand, or staple, goods

Convenience items

Impulse, or luxury, goods



The same principles carried out in practice: Rand-McNally Map Shop, New York, Dawson and Oliver, architects. Two entrances, one from a building lobby and one from the street, complicate the problem somewhat; but locations of "demand," "convenience," and "impulse" goods, and of "services," have been studied in relation to customer flow. Design of the central fixture tends to concentrate interest at appropriate points.

and services can be analyzed by classification. Most objects can be placed in one of the following classes, relating them to the needs of customers:

Impulse, or luxury, goods are high-profit articles, usually (but not necessarily) high in price.

Convenience items are stocked for the passer-by who happens in, but who may return for other purchases if properly impressed. Often these are not in themselves strictly profitable merchandise.

Demand goods are also staples, like conveniences, but are articles which the customer starts out with a definite idea of purchasing. These attract him to the store and he buys them—other goods must be sold to him.

These classifications necessarily overlap; but, in a shop whose type of customer can be forecast, divisions along some such lines are possible. Signs are not always necessary; each department may be designated by display of typical articles as a kind of poster.

Customer flow: The accompanying diagrams based upon analyses of traffic through museums* indicate the possibility of organizing departments in relation to the flow of customers through the store.

Interest in articles on display was found to be inversely proportional to the number displayed after a low limit had been reached. A central location in a group seemed to lead to increased interest in a picture. One important conclusion from these studies is that what a visitor—or customer—sees is more influenced by the arrangement of the room and the walking habits of visitors, than by the intrinsic quality of the objects exhibited. Tendencies to turn to the right, to be attracted by doorways, to choose the wider of two aisles, and to be fatigued by too much material on display are all of utmost importance to the store planner.

Store services must also be analyzed in relation to customer flow. A more

complete discussion of this subject is contained in pages 104 and 105.

Self-service: Operators of large stores have found that a certain amount of self-service speeds up selling. For that reason their stock is easily accessible to the shopper. Often, too, customers insist upon handling merchandise, and are more easily sold when they can get these first-hand impressions. As a result, many stores have abandoned the selling-over-the-counter plan, which decreases free sales space, and rely upon open wall fixtures, wall displays, and display tables whenever possible.

In direct contrast to this type is the exclusive shop which keeps its stock in closed fixtures or in the stockroom, permitting selection of merchandise only by sample displays. Some specialty shops work entirely on this basis.

Shop sizes are far from standardized. However, as determined by real estate values, and merchandising, structural, fixture, and aisle space requirements, shops with one customer's aisle only are usually 12 to 15 ft. wide by 50 to 60 ft. long in large cities; and 15 to 18 ft. wide by 60 to 80 ft. long in smaller cities. These dimensions apply particularly to shops in 100% retail districts.

Heights are more easily determined. Basements 8 to 9 ft. high, in the clear, permit economical stock storage. Ground floors are preferably approximately 12 ft. high if no mezzanine is included; mezzanines at least 7 ft. 6 in. above floor level will accommodate most fixture heights. Height from mezzanine floor to ceiling may be as low as 6 ft. 6 in. if used for service space only; 7 ft. is the preferred minimum for public use.

Structure: Column spacings, and consequently most store widths, are often determined by the structural requirements of the building in which the shop is located. Use of maximum possible column spacings (at least 13 ft. center to center, preferably 20 ft.) will permit the most economical shop layout. Changes

in level of floors, or "breaks" in walls or ceilings, interfere with fixture layout, and may complicate the installation of ventilating or air conditioning ducts. Wall pilasters, if used, may be furred out to a depth equal to the depth of wall cases.

Floors have to support live loads of from 75 to 100 lb. per square foot. If framed in wood, floors may have double joists on 11 ft. centers (approximate) to permit changing stair locations. Basement floors and walls ought to be waterproof to protect stockrooms or workrooms.

Ceilings may be furred down to conceal duct work, electrical wiring, and sprinkler systems. The minimum depth for some types of recessed lighting fixtures is 1 ft. 1½ in.; 3 ft. of furred space will accommodate most duct work and permit easy access to wiring and sprinkler systems.

Interior finish: For flooring, the principal performance requirement is ease of maintenance. The maximum degree of comfort compatible with low maintenance costs, is also essential.

Subfloors are most often of wood; no matter what the material, permanently true, level surfaces are required. To this end, wood subflooring should be well seasoned to eliminate warping which may impair the floor finish.

Resilient flooring materials help to minimize breakage of fragile stock, and may add to customers' comfort.

Asphalt tile, linoleum, cork tile, and similar materials are generally satisfactory. Slipperiness, especially in rainy weather, has been successfully counteracted by polishing floors with wax to which rosin has been added. In shops in which customers smoke, asbestos tile may be used. Carpet, either in large pieces or in tile form for cementing down, is often used in the more exclusive type of shops, where traffic is not unduly heavy, or where its use will help to attract patronage.

Walls and ceilings of specialty shops are often surfaced with materials usually found in residential work: wall-

*Arthur Weever Melton, "Problems of Installation in Museums of Art," American Association of Museums, Washington, 1935; also research by Professor E. S. Robinson of Yale University.



J. H. Köhler

Brooks' Store, Utica, N. Y., Telchin and Gina, architects; counters are omitted in shoe, millinery, and clothing depart-

ments. General lighting fixtures are semi-direct; display lighting, concealed direct.

paper, fabrics, washable paints, etc. If merchandise displays are to be affixed directly to the walls, it may be advisable to provide a nailable surface which can be easily patched. Wood, natural or processed, and special types of plasters, are available.

Baseboards are ordinarily omitted or set flush with wall finish, to permit wall fixtures to fit closely to the walls. Mirrors are used on wall surfaces to disguise unavoidable "breaks", to minimize column projections, increase apparent floor area, and sometimes to aid in making store supervision easy.

Colors vary in relation to the lighting problem and to the general character of the shop. Light tints having high reflectivities are ordinarily essential when most of the shop lighting is supplied from totally indirect sources. When lighting is direct, and highly concentrated in a few low display areas, walls and ceilings may be somewhat darker. In special instances, as when ceilings are too high in proportion to floor area, darker colors may be used to minimize apparent heights.

Electrical layouts must be studied in re-

lation to each job. General requirements include convenience outlets at floor level, for floor cleaning machines, and fan outlets usually above fixture height. Both of these may be provided 20 ft. on centers. For lighted showcases, one floor receptacle is needed for each 12 linear feet of showcase.

General lighting intensities are ordinarily lower in specialty shops than in other retail-store types. Display lighting is relatively higher and more carefully planned. Fixtures for general lighting are usually semi-indirect or indirect; for displays, concealed direct fixtures, louvered spotlights, the newer types of silvered spotlight lamps, direction-controlled lighting, and similar methods, are used. In showcases, using the standard fixtures which are available, from 40 to 60 watts of incandescent lighting will provide intensities of from 50 to 100 foot candles under normal conditions. Where colors are important, for matching, testing, or determining true values, special fixtures for such types of lamps as mercury vapor, or the newer fluorescent lamps, are necessary. These latter require special receptacles and individual transformers.



Gottschlo

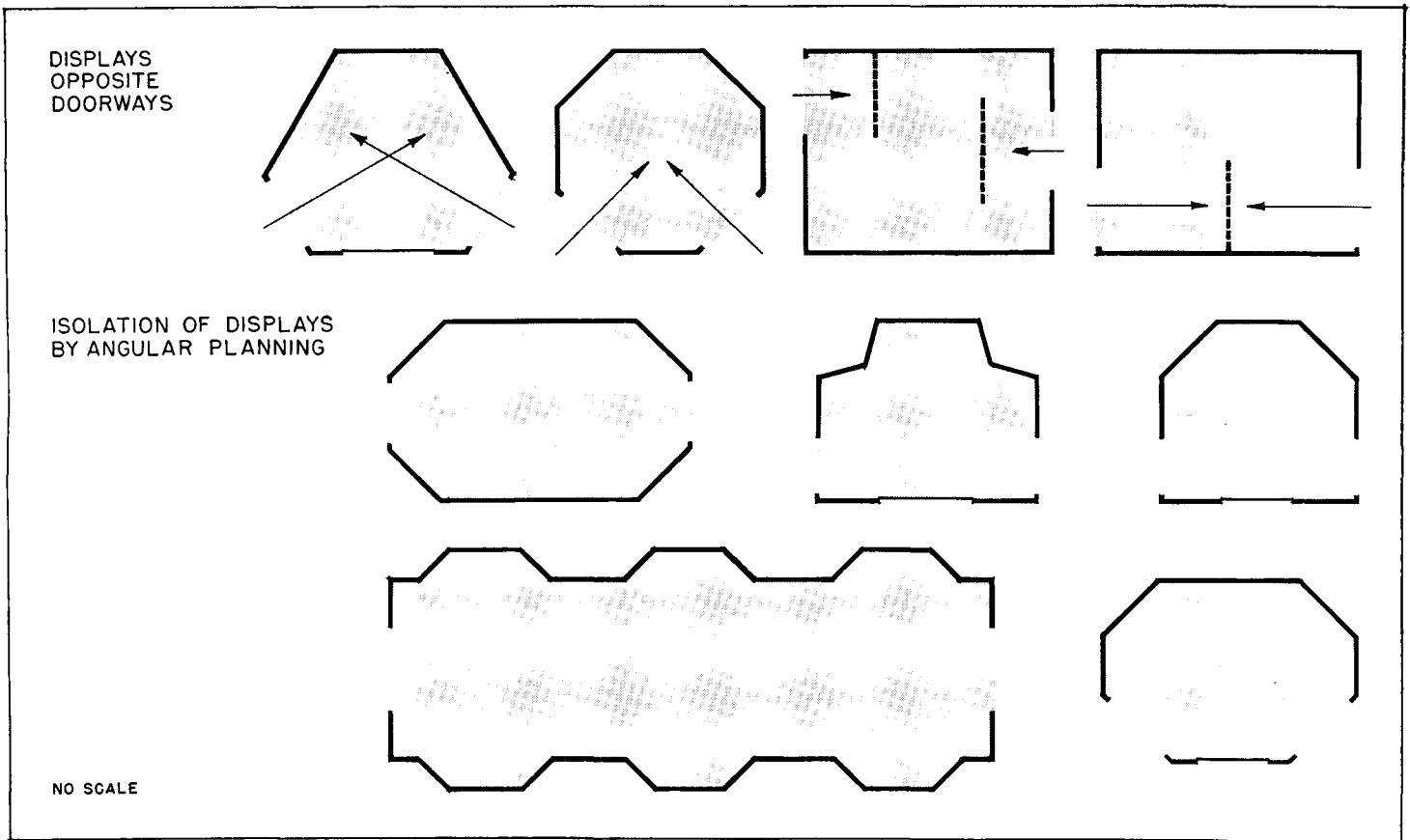
Above, interior of a Stetson Shoe Shop, Morris Lapidus, architect. At the upper right, facing the entrance, is a display screen and counter; at the left, an across-the-corner display of accessories of the convenience or luxury type, so situated that no customer leaving the store fails to see it. Below, left, accessible self-service display rack in the Chanel Bookshop, New York City, Dawson and Oliver, architects; lower right, angular displays in dress salon, Rosenberg Shop, Evanston, Illinois, Sidney Morris, architect



Frederic Arden Pauley



Hedrick-Blessing



RESEARCH and, to an extent, practice in the field of museum and gallery planning furnish data which is peculiarly adaptable to specialty shop design². The segregation of displays in areas specifically designed for the purpose, and in locations selected with respect to room entrances and customer traffic flow, is easily accomplished in departmentalized store planning.

Locating display surfaces perpendicular to the line of entrance may result in angular plans, or in the use of screens or free-standing display cases, as indicated in the diagram above. Locations for display niches, alcoves, etc., may depend on space requirements of the various shop departments, and upon the relationship to customer flow lines.

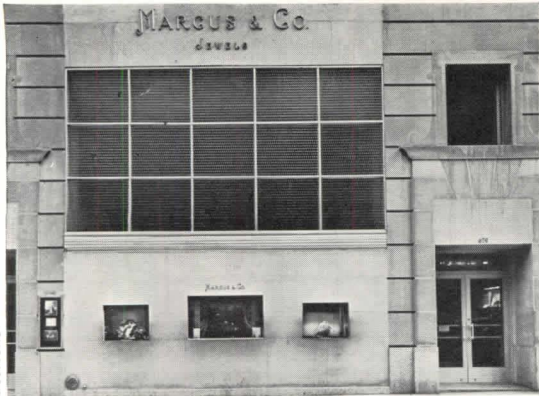
²Data and drawings reproduced by courtesy of Clarence S. Stein.

In a shop, "architecture" is preferably secondary in importance to the merchandise displayed. This does not mean that every inch of space must be crowded with goods "on display," because such practice causes loss of customer interest.

Scale: An important factor in display is the relation between the possible viewing distance and the scale of the merchandise. Thus a stairway side wall or narrow passage is suited for small scale display only. Vistas, on the other hand, and displays opposite doorways, have more carrying power and consequently can be bolder. Vistas, or a sense of perspective, can also be created by lighting emphasis. When a lighted display is placed at the rear wall under a mezzanine space which is slightly darker

than the store proper, a spatial relationship is set up which depends more upon the relative intensities of light than upon actual distance. It is possible to dramatize objects on display, to make them stand apart from their neighbors and in this way suggest that they are more desirable. On the other hand, it is not always best to separate costly and expensive objects. Low-priced merchandise may often be sold by contrast with high-priced objects, and vice versa. Choice of method depends to an extent on the problem under consideration.

Accessible zones, rather than low or high displays, are particularly valuable in self-service portions of the shop. Just as show-window bulkheads are rising and glass heights decreasing, so the fixtures inside the store are bringing merchandise within reach, and concentrating it for emphasis.



Gottschko

Small show windows with "invisible glass"; ribbed glass above admits light to shop.



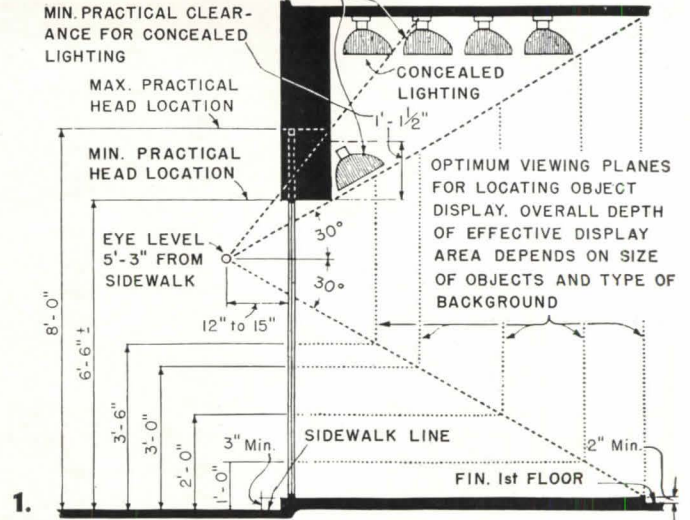
Hedrich-Blessing

Ground- and mezzanine-floor show windows, women's wear shop in Chicago; Sidney Morris, architect. Below: In this Los Angeles shop, the store interior provides the display; Albert C. Martin, architect.

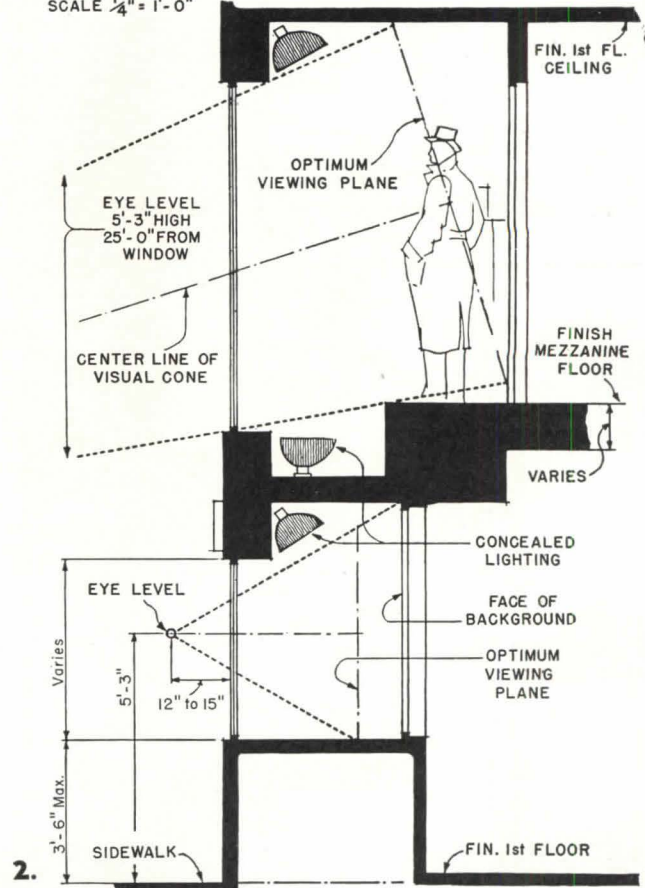


Mott Studios

LOUVERED LIGHTING FIXTURES MAY PROJECT INTO VIEWING ANGLE



SCALE $\frac{1}{4}'' = 1'-0''$



Drawings courtesy Libbey-Owens-Ford Glass Company

Determining Optimum Show-window Depths

Within a 60° cone, the average human eye sees comfortably, without appreciable physical effort. Optimum viewing planes are those in which objects on display can be seen in their entirety without causing the eye to encompass arcs greater than 60°. Diagram 1 illustrates a graphic method of determining optimum viewing planes for given bulkhead heights. Diagram 2 shows the application of these principles to second-floor windows; sight lines are limited by practicable window dimensions. Diagram 3 extends basic principles to include both basement and first-floor levels, seen through one window.

SHOW WINDOWS are designed primarily with the effect upon potential customers in mind; ease in changing displays is also important. Windows must be "dressed" quickly; if they are hard to work with, they will not be changed as often as merchandising policies indicate to be necessary. Variety and timeliness of displays are considered essential.

The accompanying diagrams illustrate one set of principles whose use increases the value of displays. The same principles may be applied to horizontal planning; the "shadow-box" type of window, with limited display space, is considered most effective by display designers. In conjunction with these, it should be noted that bulkhead heights tend to increase as the size of objects displayed decreases, to permit more minute examination of merchandise.

Glazing of types which do not interfere with vision will materially increase the show window's value. Vertically curved glass is sometimes installed at window corners; in such cases there are often distorted reflections which detract from window displays. Patented systems, which eliminate reflections, are available; so are types of glass suited to special conditions, such as heat-resisting glass. Simple borders painted

on the glass, or simply designed, non-rectangular frames, are sometimes used to enhance displays.

Window backs may be closed or open, depending on the type of shop and the degree of customer privacy desired. When backs are open, confusion of display and shop interior may be avoided by using temporary or permanent screens or panels as backgrounds.

Window dressing may be done in full public view in certain types of shops, as jewelry or gift shops. In other cases, venetian blinds or other types of glass curtains may be required. Apparent size of glass area may be changed to accommodate varying displays by using variable valances and side-pieces.

Storage space is required for display accessories, forms, blocks, platforms, panel backgrounds, and seasonal changes of floor pads or carpets.

Ease of window dressing may be aided in several ways. Access panels should be large enough for easy passage for men and materials. Access passages, segregated from the shop's interior, may be provided. Dummy windows may be provided, sometimes on rolling platforms. Elevators, or rising platforms, have been used. On these, displays are completely fabricated in the basement; platforms are then hoisted vertically into place. If double-decked

windows are desired, the upper level may be dressed above the upper show window and dropped into place from above.

Mechanical ventilation of window spaces increases the comfort of window dressers and may help to preserve merchandise.

Show window lighting: In many stores other than specialty shops, light intensities have been increased far above requirements for ordinary vision, in an effort to overcome reflections. This has also been considered a means of competing with adjacent store windows. In specialty shops, however, there is a definite tendency to limit light sources to, say, two or three spotlights, possibly with color equipment. In some specialty shops, even the usual row of ceiling reflectors is omitted. Show-window ceilings are often painted black; spotlights, or silvered reflector lamps in swivel sockets, are in common use.

There is also increased use of angular lighting, from concealed vertical strips at the sides, or from portable reflectors placed on the bulkhead for upward angles. Complete, built-in footlights are not popular; but a few small spots, recessed and on swivel mounts with hinged tops flush with the bulkhead, could be extremely useful.

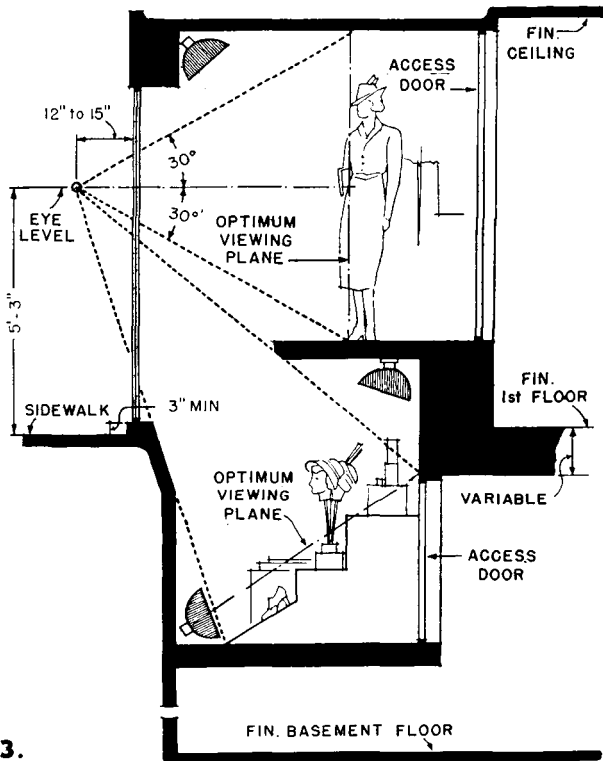
Shop entrances: Show windows cannot stop at merely attracting and stopping passers-by. Patrons must be induced to enter the shop.

Steps are considered inadvisable. When a change in grade is necessary, and it is too great for a ramp, the steps may be in the store, well lighted.

It is necessary to provide some form of protection from drafts at entrances, particularly in cold climates. In air-conditioned stores, in order to maintain the conditioning system's efficiency at a maximum, a seal between indoor and outdoor air may be needed.

Vestibules offer such protection, and may be made removable in summer months. Revolving doors are often essential where wind pressures are high, when volume of traffic is great, or when air conditioning is used.

When such materials as tempered glass are used for doors, with frames omitted to eliminate visual obstructions, warm air blasts from unit heaters may be directed across the openings to offset drafts through cracks between doors.



3.



Gottschko



Gottschko

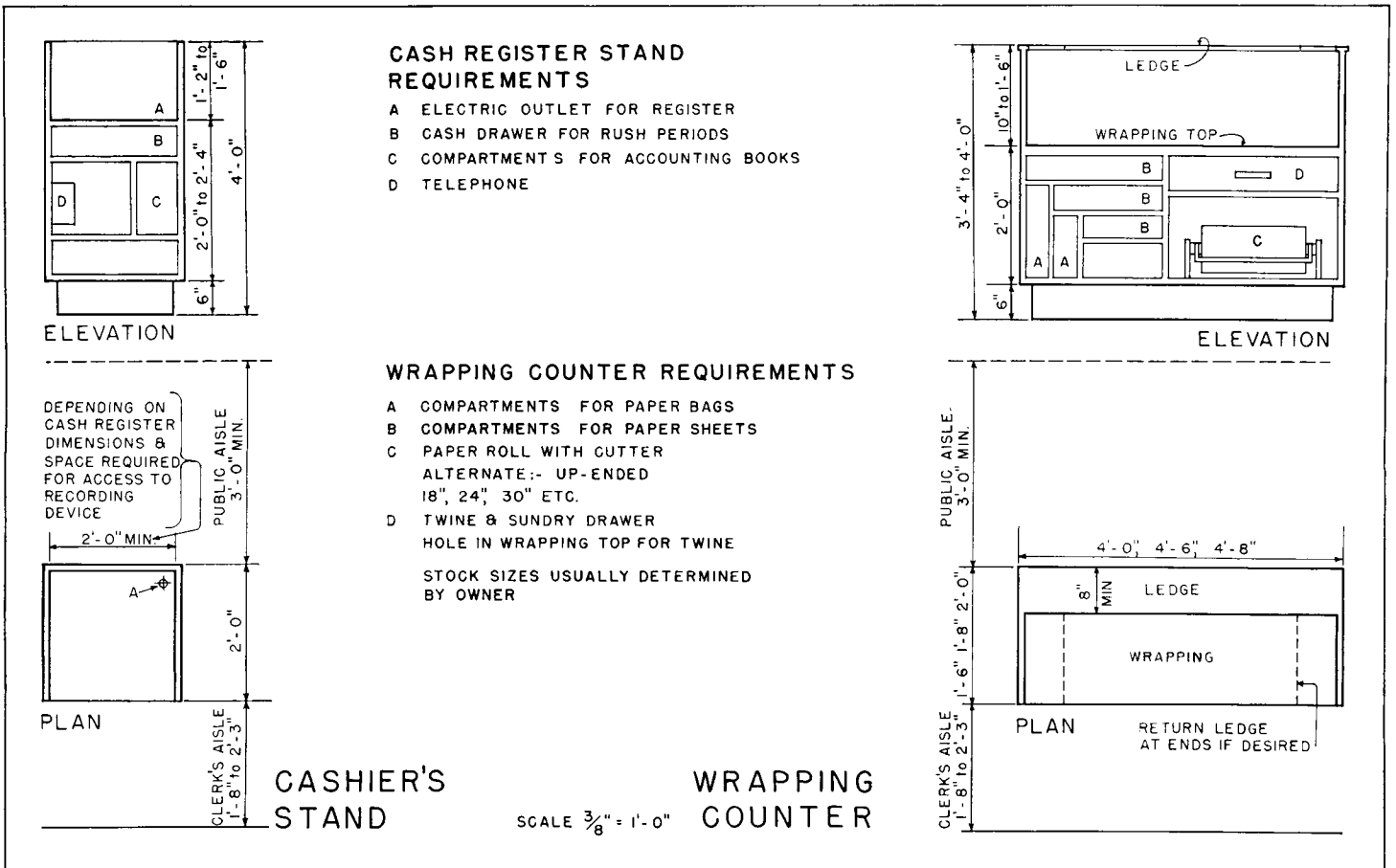
At left, above, entrance lobby to office building, Stetson Shoe Shop, John M. Hatton, architect; right, wrapping counter and cashier's desk in the same shop. Locations where customers wait for change or parcels have unique value for displays of "luxury" merchandise. Below, left, interior of the Marcus & Co. jewelry shop, planned by Kenneth I. Van Cott, general manager. The mezzanine contains offices; supervision of the shop area is possible through the semi-obscure glazing. At right, check and card-writing desk, The Cotton Shop, Winold Reiss and Albert Charles Schweizer, designers.



Bennosché



Parfley



Wrapping and cash register counter locations require study. The type of shop will determine whether these services should be out in the open or concealed, near or remote from the door; positioned to permit a salesclerk to make change while facing the doorway, or, as some managers prefer, to do nothing else when ringing up sales. In other shops, a cashier is considered to provide better control and efficiency. Some shops have a separate room or curtained alcove for wrapping and cashier space, or a basement or mezzanine served by dumbwaiter and pneumatic tube.

A cash register and wrapping counter in an alcove near the door, which permits the clerk to face the shop and doorway, is desirable in small shops where business is hurried, or where for long periods one clerk must sell, order, wrap, ring up sales, make change, and watch the shop. A store with narrow entrance might better have these services remote to avoid crowding at the doorway. The

separate wrapping room, basement, or other space is used in stores with a more leisurely trade, or when, as in many gift shops, goods are fragile and rarely carried out by the customer. It is less confusing and less "commercial" in appearance for the shop as a whole to have this service outside of the selling space. However, such planning increases customers' waiting time.

Proper location of the cash register for safety may also be dependent upon a wide variety of factors such as number of salespeople, type of show-window back (open, or closed ones which conceal the shop from the sidewalk), and type of neighborhood (busy, or quiet).

There is in the more exclusive small shops a tendency away from the use of cash registers. Some merchants consider them too commercial in appearance and provide a simple cash drawer, sometimes without a bell alarm. This naturally is a case of individual preference and reliability of personnel.

Waste basket space should be provided in each department. This can be arranged under a counter or in a back fixture near the wrapper by omitting the base. When in a counter with recessed toe-space at the front, such waste basket space will have a small ledge—the top of the toe space—which should be continuously braced.

Offices: Mezzanine space overlooking the store is the most popular location for management offices. Venetian blinds are often used as a screen; semi-obscure glass may be used; transparent mirrors can also be used, but the space they conceal must be darker than the store side. A practical way of doing this on a mezzanine used for working offices is to run the corridor along the front of the mezzanine, separating the mirror-screen from the offices.

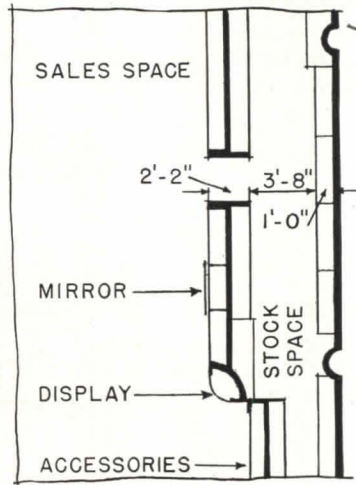
Additional types of non-selling spaces vary with the type of shop, and are discussed in the following pages.

SHOP TYPES: WOMEN'S WEAR



Piaquet

Stock and sales space for women's shoes; Swope's, St. Louis, Mo.; George W Sanger, architect.



IN SHOPS for women's clothing and haberdashery, the turnover of stock must be rapid, as styles quickly become obsolete. Most articles, other than accessories which are easily damaged or lost, are currently at least partly sold on a self-service basis.

Sales and display areas: Departmentalizing is necessary, due to the varied kinds of merchandise sold. Novelty jewelry, stockings, gloves, and sweaters are all placed near the store entrance; coats, dresses, and hats are farther back in the shop. Sweaters and knitted suits are kept on shelving, usually glass, because hanging stretches them out of shape. The hat department requires some separation from the rest of the shop.

It has been found important in all apparel shops to have several display niches, really interior show windows with or without glass, which should be lighted, for the display of ensembles and related accessories. This is almost essential to suggest associated articles.

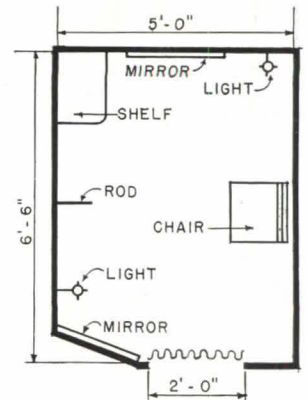
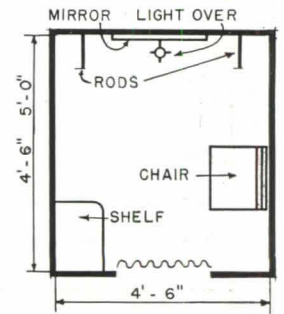
Triple mirrors are needed where clothing is to be tried on. Double mirrors, angled to one another, may prove as satisfactory as triple mirrors. Hand and table, wall or counter mirrors are needed in millinery departments.

Mechanical systems: Lighting of triple and other mirrors and fitting rooms is extremely important. Strong direct

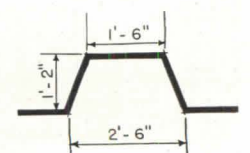
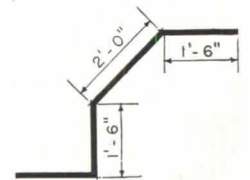
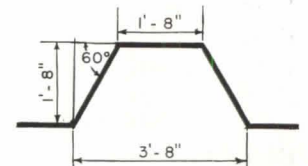
overhead lights are to be avoided because they cast unflattering hat shadows. Well diffused indirect light with direct side light has been found fairly satisfactory. Special "daylight" fixtures and lamps are helpful in color matching.

Non-selling areas: A workroom for marking merchandise, making small repairs, and preparing articles for display is needed. A short hanging pole, some 12 in. shelving, and space for ironing-board use are required. The minimum area can be 4 by 6 ft. Larger shops may have a complete alteration department. The corset shop may profitably have an alteration room visible from the shop, perhaps raised a step above the store floor, since such merchandise is "individualized." An area of 4 by 4 ft. has been found sufficient for a small shop.

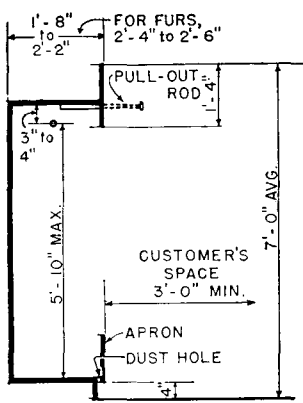
Custom millinery workroom equipment: Combined steamer and drying cupboard, 2 by 4 ft. in area, with gas and water connections; sewing machine; ironing board with electric steam iron, refillable, no water connection needed; work table, shelf at back, mirror set on diagonal at one end; large drawers for rough bodies, trimmings, and scraps; pegs for sample bodies; bins and pegs for work in progress or completed; ribbon shelving, 4 in. wide, with edge strip, approximately 6 in. center to center.



Fitting rooms; 3 by 4 ft. is minimum size; 4 by 5 ft. is preferred for corset fitting.



Triple mirrors

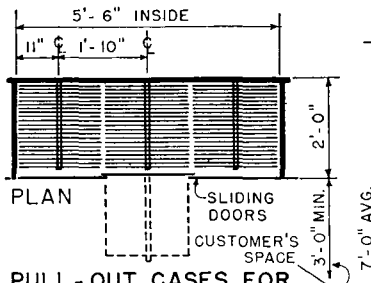


**SECTION
TYPICAL CASE FOR
DRESSES AND COATS**

LENGTHS: 4'-0", 5'-0", 6'-0",
14 HANGERS PER FT. OF ROD

ROBE & NEGLIGEE CASES
REQUIRE DOORS, MAY OMIT
APRON; EVENING CLOTHES
CASES, OMIT APRON

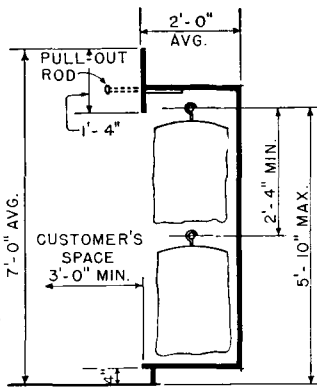
HANGING CASES



**PULL-OUT CASES FOR
BLOUSES, SKIRTS, JACKETS;
possibly double-decked type**

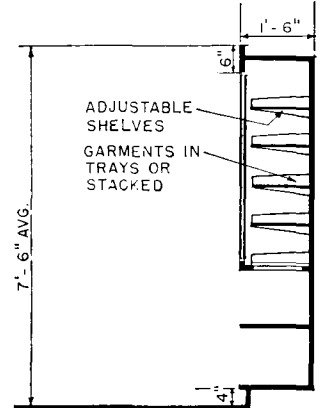
ACCOMMODATES 12 HANGERS PER
FOOT OF CARRIER

DOOR DESIGN MUST PERMIT PASSAGE
OF GARMENTS AND HANGERS

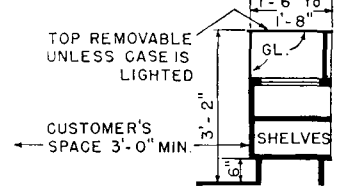


**SECTION
DOUBLE-DECKED BLOUSE
& SKIRT CASE**

LENGTHS: 4'-0", 5'-0", 6'-0",
14 HANGERS PER FOOT OF ROD

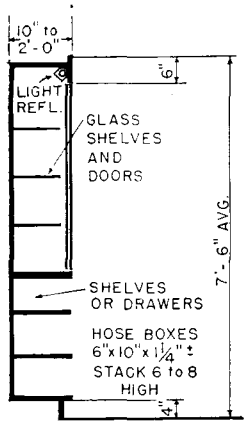


**SECTION - WALL CASE
LENGTH: 4'-4" FOR 4 12" TRAYS;
6'-6" FOR 6**



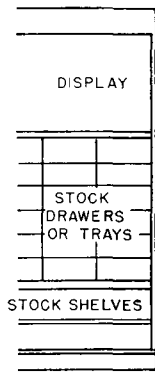
**SECTION - COUNTER
UNDERWEAR and
KNIT GOODS CASES**

ALL DRAWINGS at SCALE: 1/4" = 1'-0"

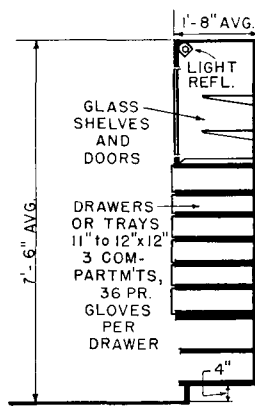


**SECTION
HOSIERY, HANDBAGS**

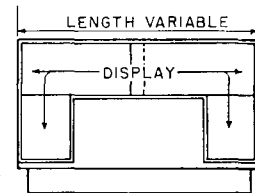
**TYPICAL WALL FIXTURES.
ACCESSORY CASES**



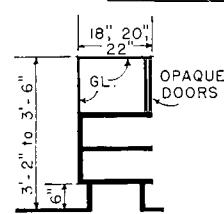
**ELEVATION
HOSIERY, GLOVES**



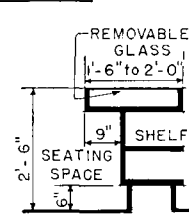
SECTION



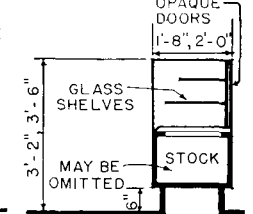
**ELEVATION
HOSIERY CASE**



**SECTIONS
HOSIERY**

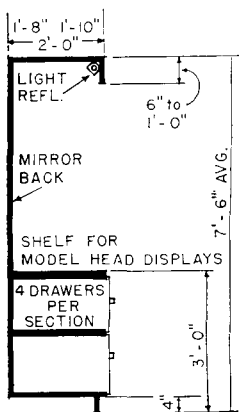


GLOVES



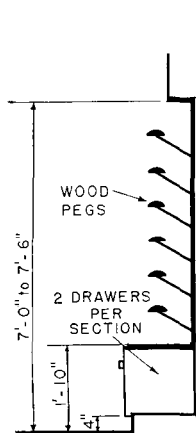
**COSTUME
JEWELRY**

TYPICAL FLOOR CASES OR COUNTERS

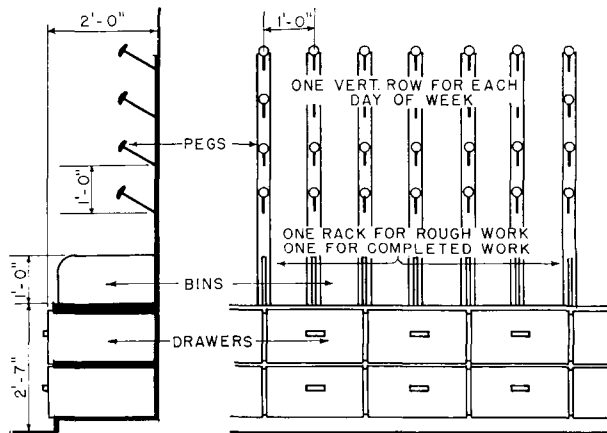


**SECTION
WALL CASES for SALES; LENGTHS, 4'-0", 5'-0"**

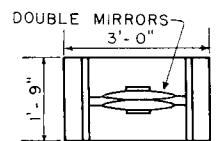
MILLINERY FIXTURES



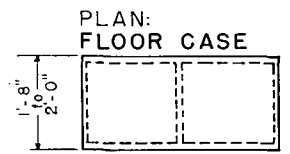
SECTION



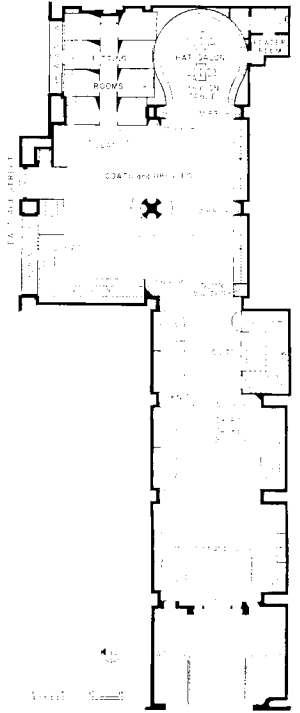
**SECTION
WALL CASES for WORKROOMS**



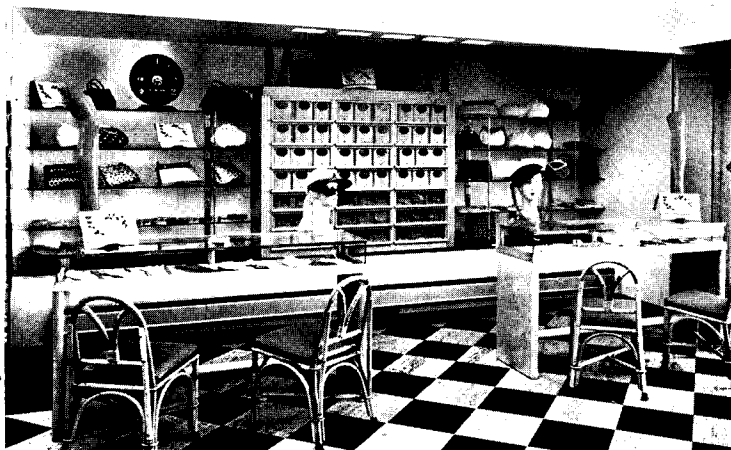
**PLAN:
TRY-ON
TABLE**



**PLAN:
FLOOR CASE
FLOOR FIXTURES**



Above, dress and hat departments; center, below, knit goods; bottom, hosiery and accessories.

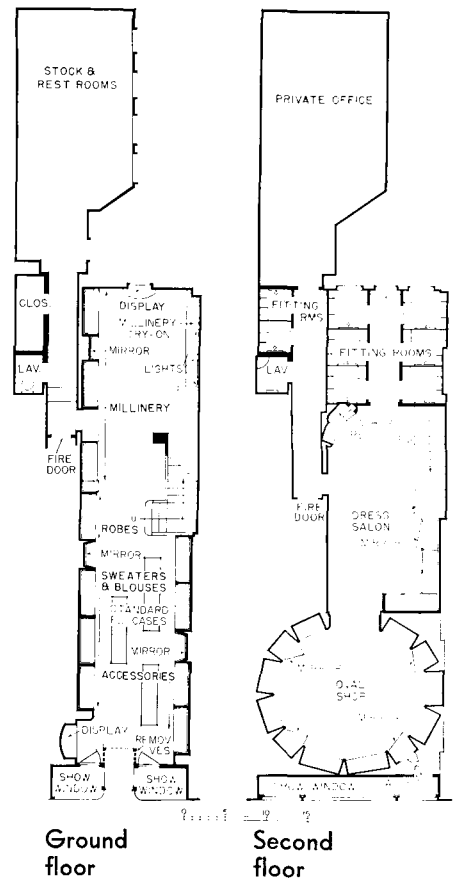


Photos by Gottscho

THIS PECK AND PECK shop is one of a chain; John M. Hatton was the architect. The management's practice is to expose all stock except accessories for the customer to examine at first hand. In this shop there are 20 feet of glove and hosiery counter and case fittings, and 30 feet of knit goods fixtures, containing approximately 170 lineal feet of glass shelving. There are 222 hat pegs, 11 hat drawers, and 150 lineal feet of hanging cases including some revolving cases for clothing. No stock rooms, closets, or cupboards are provided for inactive merchandise; all goods are expected to "turn over" rapidly. Fitting rooms are of a type detailed on page 106. An alteration workroom is contained in the basement. Seats are provided wherever possible, and a powder room is also available for customers' comfort.



Above, view into Oval Shop from Dress Salon; center, below, hanging cases in Oval Shop; bottom, knit goods cases, ground floor.



THE COTTON SHOP, New York City, Albert Charles Schweizer, architect; Winold Reiss, decorator: this shop contains approximately 65 lineal feet of hanging cases, 40 feet of cases with glass shelves and drawers, 10 feet of millinery fixtures, and 12 feet of millinery try-on wall counter.

Store departmentalization played a part in determining the stair location. The stair opening serves to delimit the accessory and knit goods department from the millinery space.

The Oval Shop on the second floor contains four mirror-fronted hanging cases instead of the common triple mirror. Both ground- and second-floor show windows are visible from across the street, and from double-decked buses.

Photos by Paculey



Swunders

Interior, The Fashion Shop, Lawrence, Mass.; Telchin and Gina, architects. Typical departments in a men's clothing and haberdashery shop include: suits; over-clothing; hats; shirts; neckties; underwear and socks; jewelry, braces, garters, and such accessories.

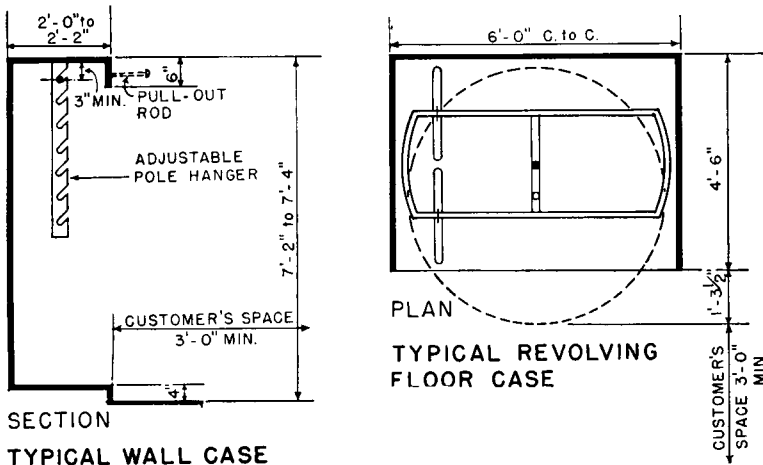


Shirts stacked in buckram trays on wood shelving; Watchung United Men's Shop, Telchin and Gina, architects.

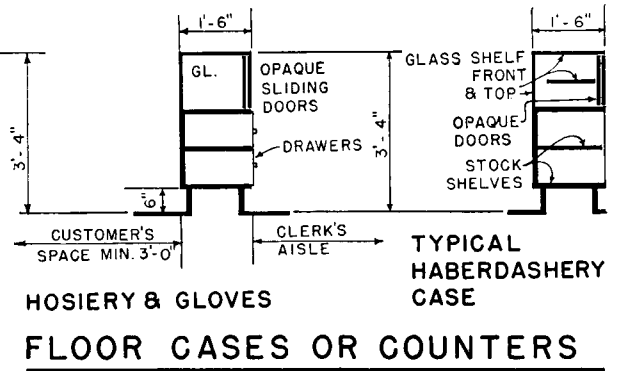


Requirements in a custom tailor's shop differ from the conventional men's clothing store needs: shelving for bolt goods and hanging cases for completed work, as provided in Hedges Shop; Telchin and Gina, architects.

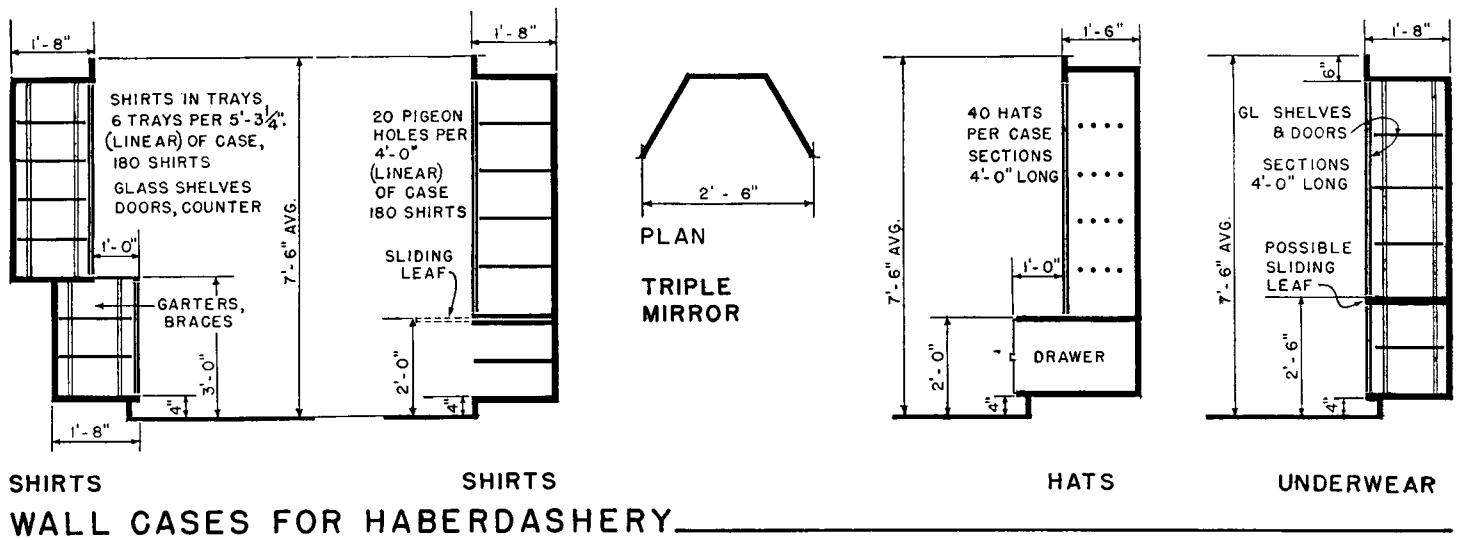
Thomas



SECTION
TYPICAL WALL CASE
HANGING CASES



HOSIERY & GLOVES
TYPICAL HABERDASHERY CASE
FLOOR CASES OR COUNTERS



SHIRTS SHIRTS HATS UNDERWEAR
WALL CASES FOR HABERDASHERY

IT IS USUAL to provide fewer closed cases and displays in men's shops than in women's shops because the materials are more rugged. In haberdashery shops 90% of the stock moves fast enough to avoid damage. Slower moving items such as robes, jackets, and suits, however, collect dust, and some shops use transparent shoulder covers when the dust problem is acute. Much hosiery fades badly when exposed to daylight or when near showcase reflectors. In some instances, however, shop owners indicate a preference for concealing the major portion of the stock, and concentrating display interest on a few selected items.

Stock must be kept up in the highly competitive haberdashery line because

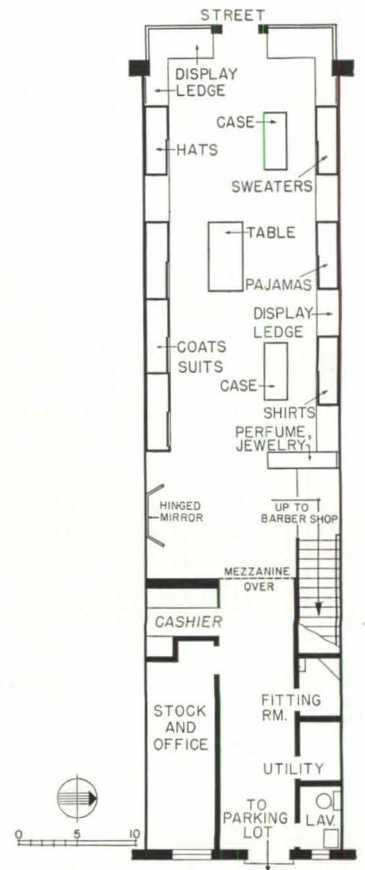
customers expect quick service, and storekeepers must plan six to eight weeks ahead for delivery. A turnover of four times is the maximum expected.

Sales and display areas: In stores selling suits and coats, tables (2 by 4 ft., 2 by 5 ft., 2 by 6 ft., and 2 ft. 6 in. high), or low hanging fixtures, are required out on the floor, for stock which has been tried on or which is being compared. Hanging cases are usually along walls.

Counters and clerks' aisles are seldom, if ever, included in clothing sales space, but are ordinarily required in combination with wall cases for haberdashery and accessories. One or more fitting rooms are necessary in clothing departments; a small fitting platform,

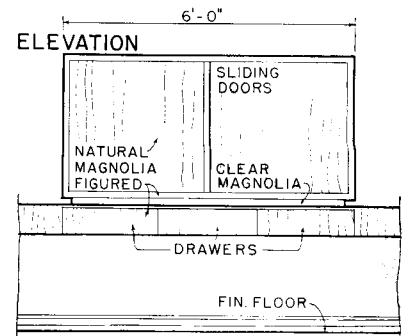
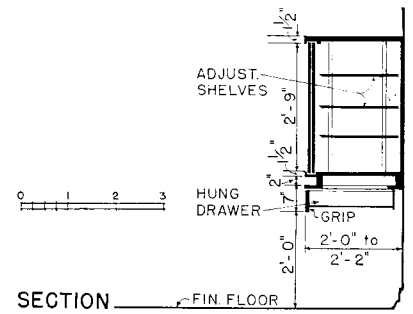
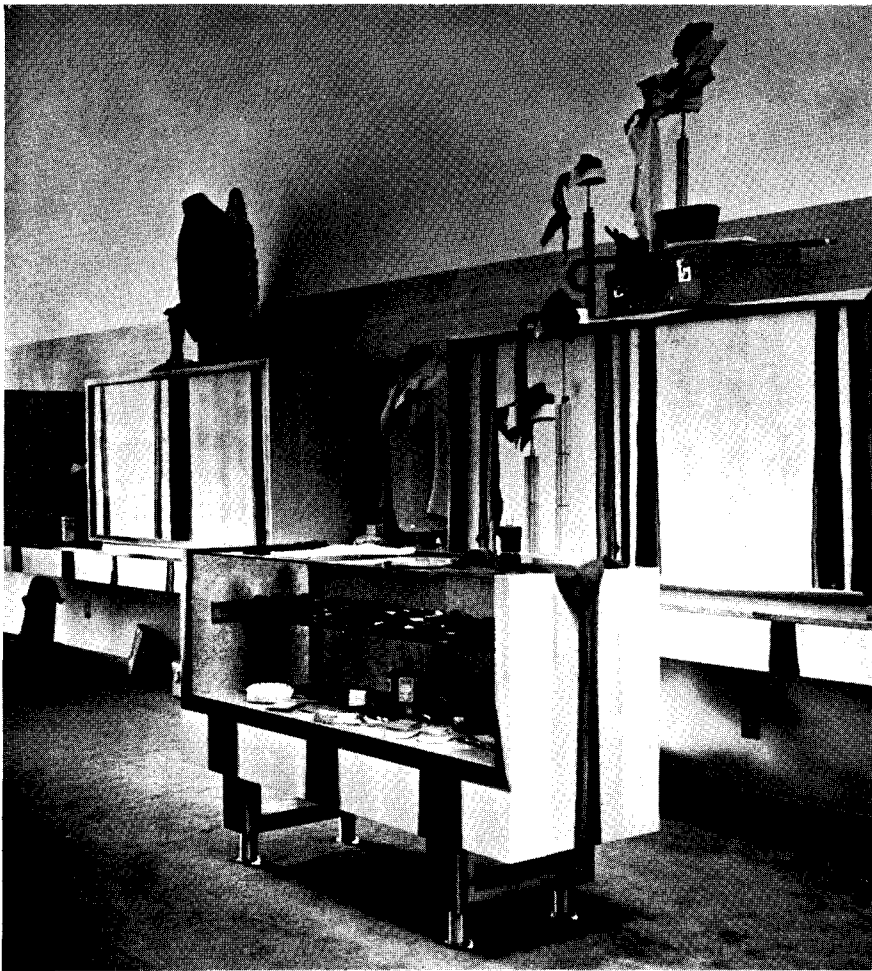
one step high and approximately 4 ft. by 4 ft., is sometimes needed. Chairs and smoking stands are standard equipment. "Daylight" lighting fixtures aid in matching or determining colors.

Non-selling areas: Stockrooms, with space for about 20 percent of the store's total stock, are usually sufficient for peak load seasons. If alterations to clothing are made on the premises, a tailor shop, with water and electrical connections for pressing and sewing machines, is required. Wrapping counters for clothing departments are often located in workrooms; for haberdashery, wrapping counters are usually combined with cashier's space, which is located conveniently to both departments.

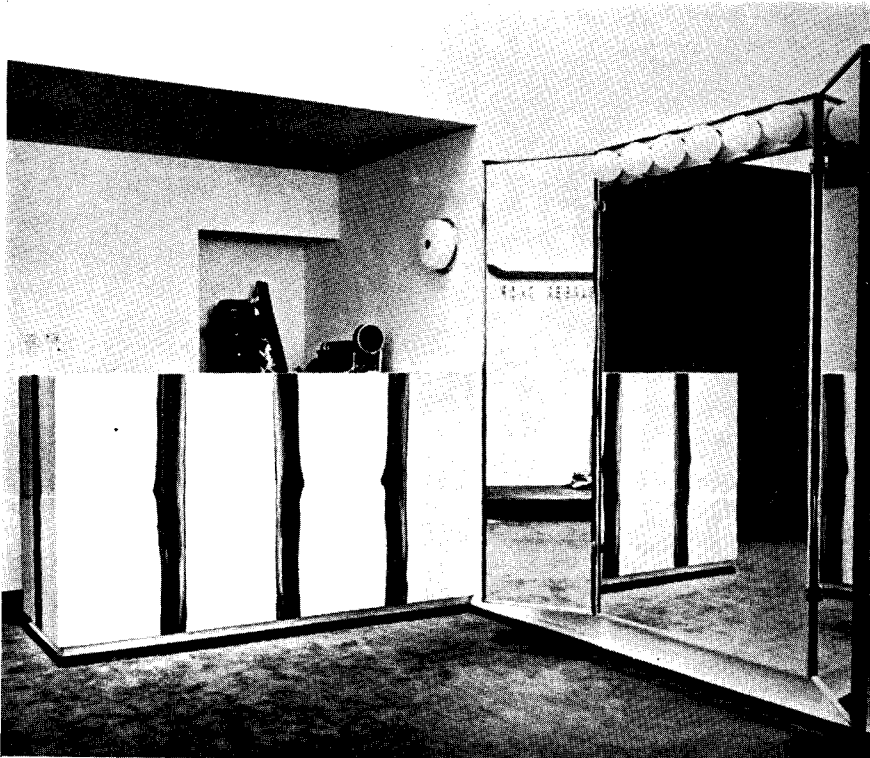


ROTHSCHILD'S MEN'S STORE, Beverly Hills, California; Harbin F. Hunter, AIA, architect. Fixture design and layout is intended to simulate the casual grouping of furniture in a home. The display ledge, continuous along the two side walls, contains stock drawers at intervals. Most stock is kept in opaque cases or a separate stock room. Show windows are open-backed; stock displayed here is also available from within the shop. Below, at right, men's shaving, perfumery, and jewelry display case.

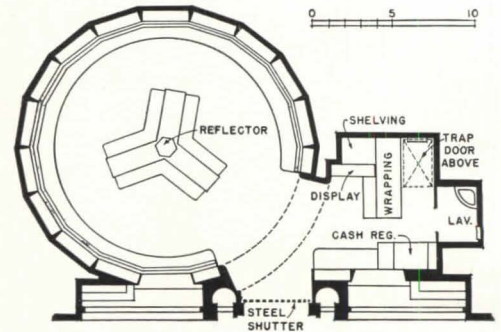




Typical fixtures, Rothschilds Men's Store; wall cases are suspended on metal brackets and partly supported by the ledge. Wood is natural-finished weather-stained magnolia. Floor is covered with dust-colored carpet; walls are grass cloth and painted plaster.



Cashier and wrapping counter, and triple fitting mirror with specially designed lighting



Plan, above, and typical views, left, of the Doubleday-Doran Pennsylvania Station Arcade Bookshop, New York City; Dawson and Oliver, architects

THE CENTER fixture effectively divides this shop's limited sales space into three alcoves. Two concentric rings of shelving for front-cover displays encircle the entire space. Wrapping, cashier, and office spaces are concentrated near the door for ease of supervision, and to accommodate hurried customers. Lighting is provided by a combination of indirect and direct sources. A fixture atop the center unit, and coves above the wall shelving, transmit light to the plaster dome overhead. A shielded fixture with modified directional control lights the "selling zone" at counter height.

Below, stock space behind the "front-cover" display shelves



Photos by Pawley

EACH CUSTOMER in a bookshop requires privacy, direct access to the books displayed, and sufficient light for comfortable vision while reading. Bookbuying customers like to browse, and nothing is less attractive to them than crowded circulation.

Sales and display spaces: The first requirement is a plan which by means of low book shelving provides alcoves or selling recesses into which customers can be drawn out of the main circulation. Such an arrangement increases lineal feet of shelving.

The second important step is to assure fairly high intensities of lighting, not only on shelves and displays, but to permit book reading without discomfort at any place in the shop.

The third step is the design of store fixtures which sell books.

The "alcove" plan is illustrated in the example on the facing page. Here alcoves are formed by the unusual center fixture. Similar treatments may be achieved in larger, or rectangular, plans by the use of various types of layouts.

Design of store fixtures requires considerable study. The front cover of a book is three or four times as wide as the backstrip. Consequently, display which features this maximum dimension secures the maximum display value of jacket design and title lettering. For this reason there is a trend, particularly noticeable in chain bookshops, to use the most accessible area of the fixture, at about hand height, for front-cover display. There are some disadvantages to this practice, including loss of stock space and untidiness resulting from piling books too high on counters. This latter practice also makes access to lower display shelves difficult. Some otherwise waste space behind vertical "front-cover" displays may be used for stock

storage, as was done in the shop illustrated on the facing page. Use of sloping counters, with rims high enough to retain only one layer of books, will prevent the second practice.

All shelving should be within normal reaching distance; the maximum height to which the average adult can reach is from 6 ft. 3 in. to 6 ft. 6 in. Display and stock tables may be introduced in wider alcoves. Aisles not less than 3 ft. wide are preferred; main circulation aisles are not usually greater in width than 6 ft. or 6 ft. 6 in., for large shops.

Non-selling areas consist of wrapping and cash register space, small office and employees' lavatory, and necessary room for mechanical system equipment. Location of all of these varies with each job. In small, "one-man" shops, wrapping, cash register, and office space may be combined and located near the entrance for easy supervision. In no case should these areas obtrude upon customer space.

Mechanical systems: Lighting is preferably high in intensity and without glare.

Direct lighting concentrated on the fixtures' selling zone—the area of the counter and of the two or three shelves immediately above counter height—has been found satisfactory. Light sources are best concealed. General lighting of the entire shop may be totally indirect, or semi-indirect; fixtures may be coves, luminaires, or any non-glare type. Exposed lamps are not ordinarily satisfactory. By far the greater proportion of the electrical load is ordinarily consumed in lighting the sales and display areas.

Ventilation or complete air-conditioning will aid in preserving stock, and is often necessary to increase the comfort of customers in the rather confined alcove spaces.

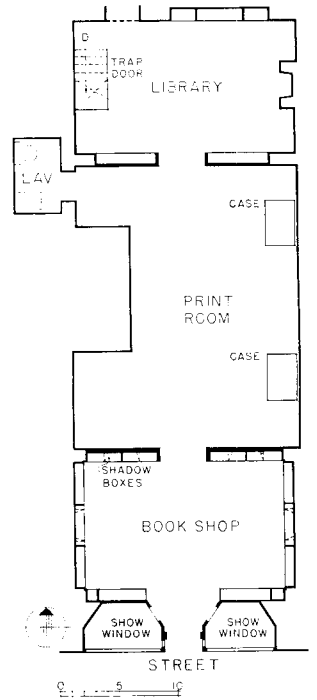


A type of sloping rack and counter arrangement which is inexpensive, and which prevents clerks from piling up books in an unsightly manner. Shelving below the inclined counter furnishes stock space. Channel Book Shop, New York City, Dawson and Oliver, architects.



Photos by Paxley

Principles of book store design are here applied to a map shop; Rand, McNally Map Shop, New York City, Dawson and Oliver, architects. Map racks are similar to those in the bookshop on the facing page.



THE CROSSROADS OF SPORT, a shop in New York which sells various articles associated with sport: prints, books, glassware, bric-a-brac, etc. The establishment, designed by Elizabeth Parker, achieves a domestic rather than a commercial atmosphere.

The shop is subdivided more completely than is common in gift shops;

many design problems are similar to those encountered in book shops. Shadow boxes inserted in shelving are intended for displays of small, fragile objects, and are independently illuminated. Lighting in the print room combines specially designed direct trough reflectors and indirect ceiling fixtures. View above shows the library.

Print room



Bookshop: card-writing desk, shadow box above



Photos by Van Anda

THE PROBLEM in designing gift shops is complicated by the variety and number of objects which must be displayed. Merchandise is seldom bought without seeing and handling either the actual object or a sample. Cleaning and arranging such a varied, fragile stock is a serious maintenance problem.

Selling and interior display areas: Departmentalizing the stock is valuable but difficult to achieve, and is ordinarily accomplished differently for each job, depending on the general type of merchandise. Objects may be arranged according to material, texture, and color; or according to function; or in mixed groupings coordinated according to probable use. Both classified and mixed groupings are considered essential. Times and seasons for various types of merchandise must be considered and display space provided to accommodate these changes in positions and importance relative to the regular stock.

Shelving is required for all small objects, such as glassware, pottery, silver, etc. Sizes range from 8 to 12 and even 20 in. in width; below counter height, shelf or stock space is often enclosed to protect objects which might be damaged by dust. Sales counters are usually eliminated; although, again, for small, perishable articles, glass show cases may be advisable. Closed displays with concealed soffit lighting have been found valuable for such objects of special value or fragility, or articles which deteriorate if left in the open (leather, silver, plaster, unglazed terra cotta). Sale of gift merchandise implies the writing of cards and notes for enclosure, and of checks. One or more desks should be provided for customers for these purposes. It has been suggested that space should be provided for telephone books and the Social Register, for addresses.

Finishes: Shelving may be of glass, wood, or metal; some shop owners prefer glass for stemware and painted finishes for pottery, etc. Shelving for silverware should have a finish which does not cause tarnishing.

Mechanical systems: One of the most difficult problems is cleaning and dusting the stock. China and glass must be

washed about once a week; they may be done in the shop or sent out to concerns specializing in such work. If done in the shop, suitable plumbing fixtures and water supply are required.

Dust elimination requires study. Proper air conditioning may be of positive aid in controlling dust; but system design must be carefully checked, filters replaced when needed, and ducts kept clean to insure against blowing dust into the shop. Small individual units may prove more effective than central systems.

Show windows: Most gift shop window backs are open, or partially so, in order to give views through into the shop. Lighted interior displays visible through open backs often attract customers. Flexibility is sometimes demanded; that is, a window with a back which may be open or closed at will. Lighted recessed shelving in the window side or backs, or on adjustable brackets, exploits varied display levels. One shop uses glass shelving in a long but shallow side-window display of glassware, visible against the light from the inside. This is a corner store; front windows have thin draperies as a background to concentrate interest on the window composition and to afford privacy for customers. Curtains also make window access easy, but fabrics are apt to collect dust and to fade in strong light.

Lighting intensities are usually low. Spotlights may be more economical and effective than standard reflectors. Color effects may be obtained, and textures or other qualities of merchandise may be emphasized, by the use of colored light.

Non-selling areas: Stockrooms require a range of sizes of wooden shelving, from 8 to 12 or 20 in. wide, as well as closed cupboards for objects which might be damaged by dust.

The receiving and packing room will have to handle large quantities of inflammable packing material. A metal-lined bin with self-closing lid is required by some building codes.

A wrapping table, 3 ft. 6 in. by 5 ft., with two paper rolls, 18, 24 to 30 in. long is usually sufficient. Weighing scales are required.



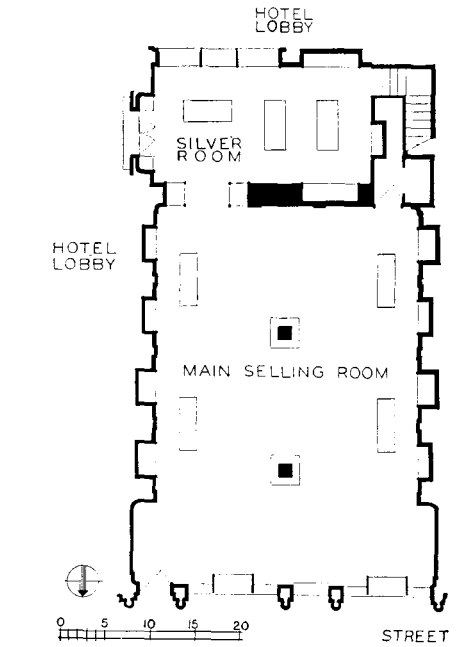
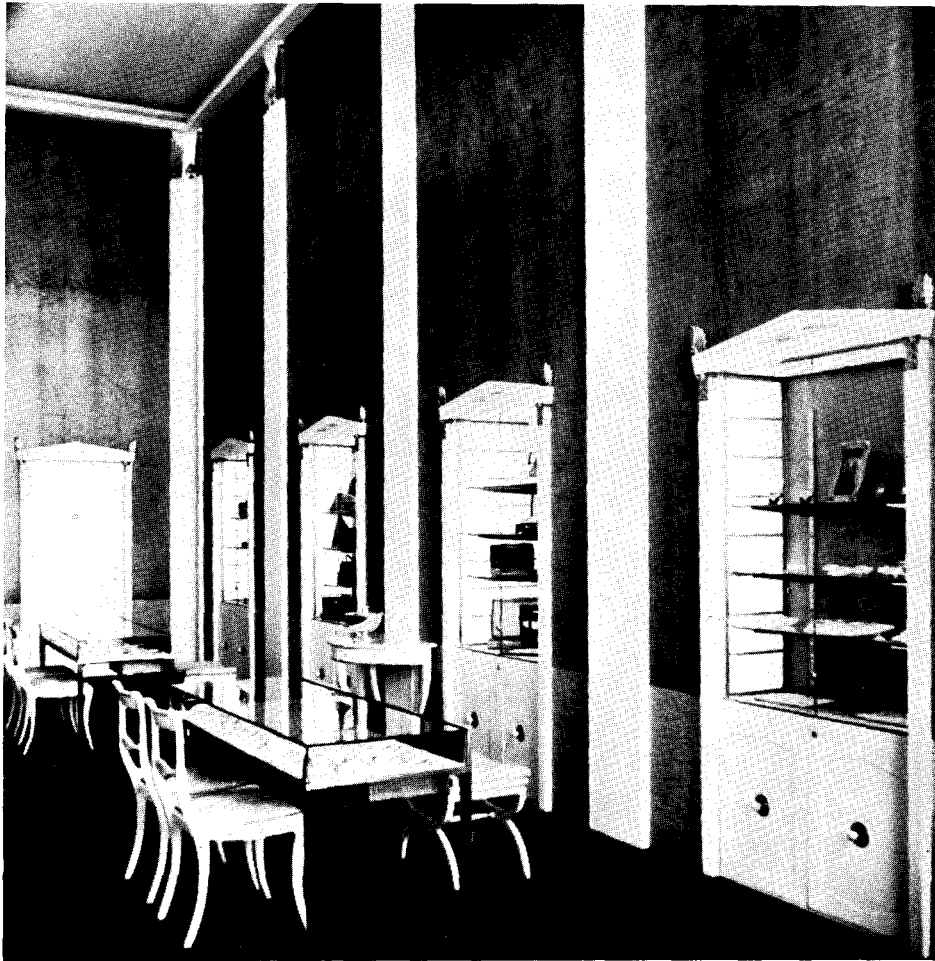
Above, open-backed show window with glass shelves, Rena Rosenthal, Inc., New York City; below, opaque shelving opens alternately into show window and shop, Gordon Waldron, N. Y. C.



Below, interior shelving in shops of Rena Rosenthal, Inc. and Gordon Waldron; the latter is illuminated by concealed vertical tubular lamps.



Photos by Paruley

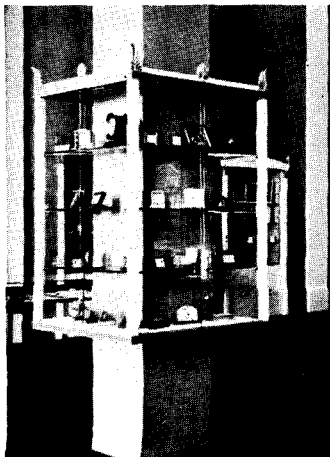


Above, plan of ground floor, showing connection with adjacent hotel lobby. Show windows, on both the lobby and the street sides, are subdivided into small display spaces, comparable in scale to objects displayed.

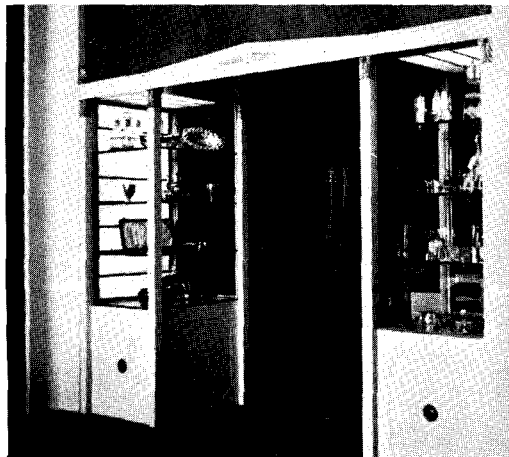
STORE FOR Brock and Company, Los Angeles, Harbin F. Hunter, AIA, architect; walls are panelled in figured woods, and the floor is heavily carpeted. Interior layout is planned to provide for personal contacts between salespeople and customers, with little or no mer-

chandise available for the customers to handle. The semi-private salesroom is, in this case, intended for showing expensive silver services rather than sale of precious stones. Space beneath stairs is used for stock storage; mezzanine contains offices.

Column display case



Entrance to Silver Room



Interior, Silver Room



JEWELRY is sold by persons trained to give individual attention to each customer. Patrons are given little opportunity to handle merchandise except in the presence of a salesperson. Valuable stock is ordinarily locked in a vault each night, and the entire store must be "dressed" each morning.

Sales and display areas are divided into a general salesroom for ordinary customers, and one or more private rooms for customers who wish to buy expensive items, usually precious stones.

No counters, in the ordinary sense, are provided; it has been found preferable to have nothing between customer and salesman. Both sit at tables, 2 ft. by 3 ft. in size, which are spaced at 9 to 10 ft. intervals for privacy. A few display cases are used, and stock drawers to hold jewelry trays. Display tables for stationery and watches are sometimes fitted with display drawers, the full size of the table, and visible through a glass top. Wall cases are often recessed in salesroom walls.

A vanity, possibly built into the wall at each side of the room, has been found a valuable aid in selling.

Private sales cubicles may be from 6 to 7 ft. by 8 to 10 ft. Furniture should include 3 or 4 chairs and a sales table. Partitions need not run to the ceiling, and may be of translucent or opaque materials—not clear glass.

Finishes: Floors are often carpeted; walls and ceilings may be papered or painted. Interior decoration of a somewhat delicate character is considered appropriate to the merchandise.

Show windows usually have high bulkheads, are small in size, and have opaque backs. Displays are usually limited, and small in scale. Glazing should interfere with vision as little as possible. In one shop, windows are accessible from a narrow alleyway. This arrangement permits the display man to work in the daytime without disturbing the store. It is also possible to remove objects without disturbing the salesroom.

Non-selling areas: Protection of stock is important, although there are few deleterious influences against which jewelry must be protected. Pearls and ivory will not stand heat. Silver will tarnish; watches and clocks must be oiled and

regulated. A jewelry polishing shop may be needed in a room adjacent to the general offices. This is about 8 by 8 ft. with benches, shelves, sink, and electrical tools. Camphor in clock cases keeps humidity under slight control.

Protection against theft is provided ordinarily by keeping stock in a vault at night, and by installing alarm systems at all windows and doors. Where available, various private, police, or similar protective agency systems are usually interconnected.

Conveniences installed for customers' comfort include private telephone booths, drinking fountains, and a lavatory, as well as vanity tables.

Offices may include spaces for manager, clerical department, telephone switchboard, and registry (accurate records of purchases are usually required by law). Offices are often in mezzanines. Shipping departments may be in basements or first floors.

The buying office, sometimes called the "diamond office", is in essence a testing laboratory containing delicate balances, microscopes, and special lighting equipment, all for examining articles offered for sale to the shop. Space is divided into two parts, public and private; sellers are never permitted to enter the private area. Tables and chairs are required in public space. Door latches may be buzzer-controlled from the private room.

Visual control of the entire shop from the general office area is desirable.

Work spaces include shops for design, manufacture, and polishing of jewelry, if such work is done on the premises.

Storage spaces are needed for the boxes in which jewelry is ordinarily delivered; and for engraving plates, orders, file work, and stock necessary to a stationery sales department.

Electrical systems, in addition to the protective system, may include annunciators and door controls. Lighting, of types which reveal true color and composition characteristics of the stock, is necessary. Carbon dioxide lamps have been found to prolong diamond-selling hours into the evening. Pencil-beam spotlights are used for examining gems for flaws. General sales space lighting, of types which are flattering to complexions and which enhance the appearance of jewelry, is found to aid sales.

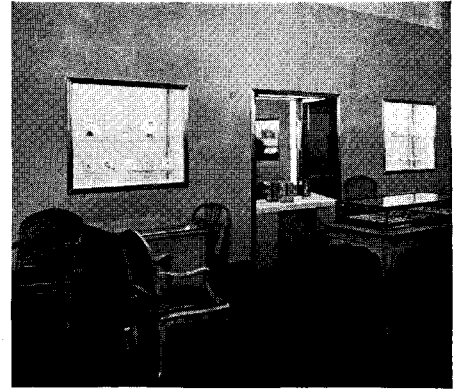


Photo by Parody

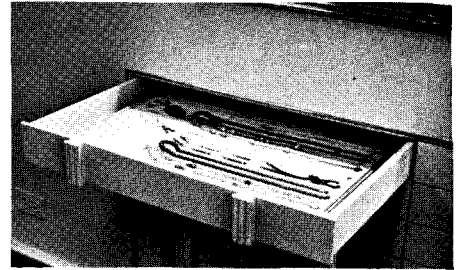
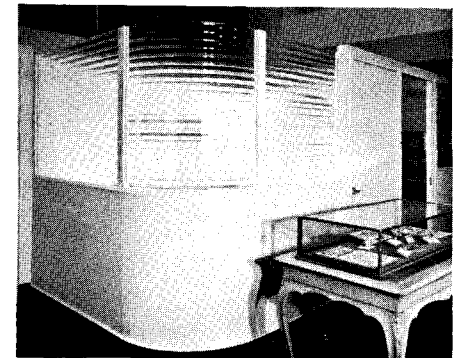


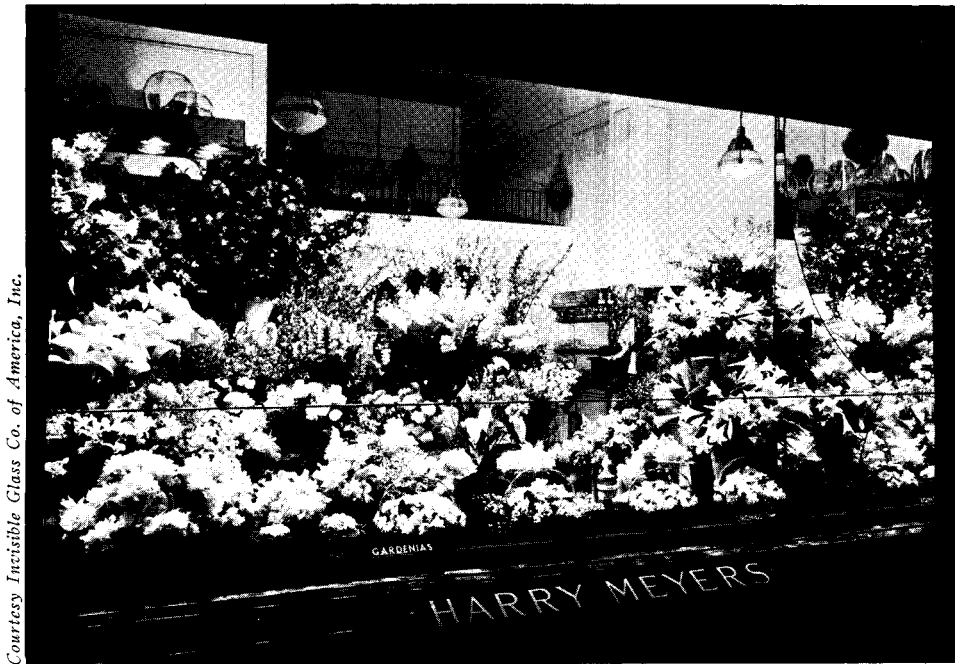
Photo by Benmosché

Upper photo, sales tables and vanity in the Marcus & Co. shop. Lower, detail of stock drawers built into wall at each table; stock is kept on individual blocks which are placed on a wheeled stand at night and moved bodily into the vault.



Photos by Benmosché

Private salesroom in the same store; partitions are Louvrex glass. Interior shows carbon dioxide lighting fixture for examining precious stones.



Courtesy Invisible Glass Co. of America, Inc.

Harry Meyers, Inc., flower shop, New York City

IN FLOWER shops, selling and display areas are combined, and temperatures must be kept low to prevent loss of stock. Show windows are almost always completely open, to display the entire shop's interior.

Selling and interior display: Refrigerated cases inside the store are usually raised off the floor on a bulkhead for ease in reaching in, and in cleaning. Maximum depth for reach-in cases is four feet. Sliding glass doors are usually standard.

Shelving and racks are required for vases and pottery. Shelf dimensions depend on the stock to be carried. Desk space for several persons, for writing gift cards, is another requirement. Desks may be of the stand-up type, possibly attached to columns.

Finishes: Floors both in public spaces and in refrigerated cases, must be impervious to water; linoleum, tile, glass brick, and similar materials have proven satisfactory. Walls are often mirrored, since repeated reflections are found to be helpful to the sale of stock.

Mechanical systems: Store temperatures are held down to approximately 50°F for best conditions. Refrigerated cases are kept at 42 to 50°F for roses and some other species of flowers. Cooling coils are usually placed in the tops of cases, with compressors in basement spaces. Some florists prefer ice refrigeration systems to mechanical systems.

In this instance, natural ice is placed in drained melting pans above display shelves.

Show windows: Bulkheads are normally two feet high. Each window may be as wide as possible, eight feet being the usual maximum. Backs are normally omitted. Bulkhead flooring should be, like store flooring, impervious to water.

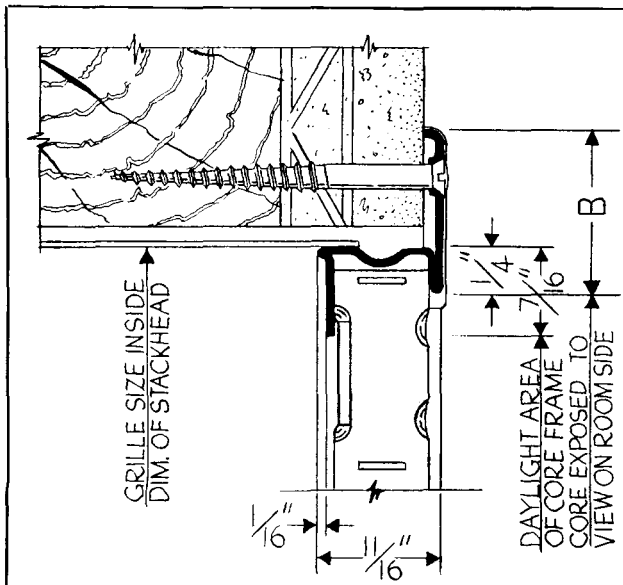
Glass should be of a type which interferes as little as possible with vision. "Invisible glass" is widely used; other types are equally suitable, such as heat-resisting glass, which reduces the need for awnings to shade delicate blooms.

Non-selling areas: Workrooms are required for preparing special displays, floral pieces, and for storing watering cans, ribbon, twine, paper, boxes, and additional pottery. Workroom sizes are not standardized. A sink with a high cold water tap, or hose, is required for filling watering cans.

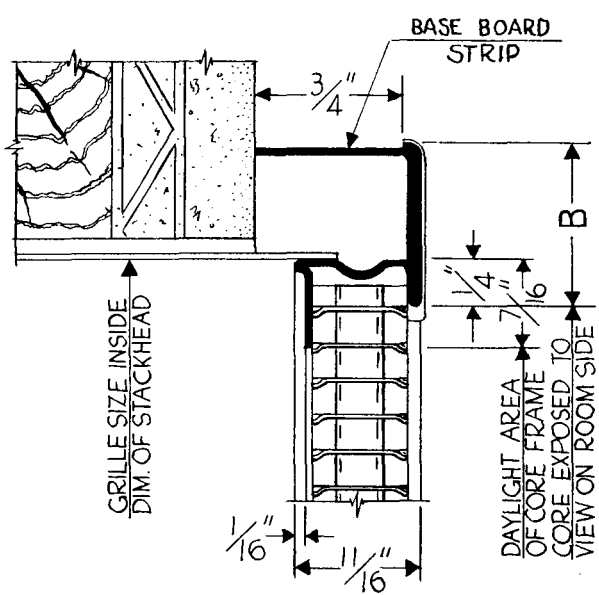
Ribbon is stocked in rolls from $\frac{1}{4}$ in. to 10 in. wide. Boxes are stacked on tables or shelves for each day's trade; 150 boxes is an average for moderately large shops. Table may be 4 by 8 ft.; box shelves may be 1 ft. to 3 ft. deep. Box sizes are as follows:

6 x 2½ x 3	24 x 4 x 5	36 x 8 x 10
12 x 5 x 6	30 x 4 x 6	48 x 5 x 8
16 x 5 x 6	30 x 5 x 6	48 x 8 x 12
16 x 6 x 8	36 x 4 x 6	(dimensions
16 x 5 x 9	36 x 4 x 8	in inches)

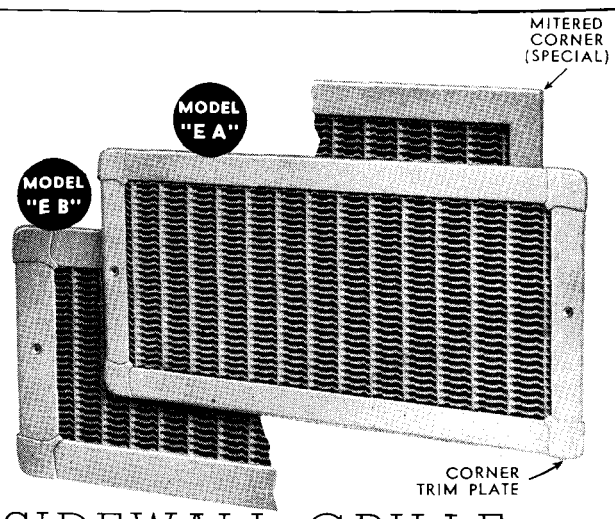
Details of **UNI-FLO** MODEL "E" GRILLES



DETAIL OF SIDEWALL GRILLE — FULL SCALE
DIM. "B" = 7/8" ON MODEL "EA"; 1 1/4" ON MODEL "EB"



DETAIL OF BASEBOARD GRILLE — FULL SCALE
DIM. "B" = 7/8" ON MODEL "EA"; 1 1/4" ON MODEL "EB"



SIDEWALL GRILLE

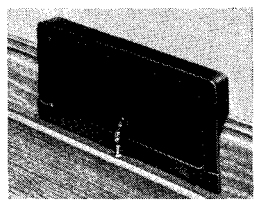
UNIT CONSTRUCTION—Model "E" Grilles have an extended flange which acts as the core supporting frame. Model "E" units are recommended for smaller size outlets common to residences, offices, conference rooms, small stores, school rooms, and the like, where lower cost is a factor and the unit construction is desirable.

INDIVIDUAL FIN ARRANGEMENTS — Model "E" UNI-FLO Grilles and Registers have a distinctive core made up of directional diffusing fins, specially engineered to give correct, complete, draftless air distribution in the given space, at higher velocities, greater air temperature differentials, and at lower noise levels.

TWO MODELS — Model "EA" (7/8" flange) and Model "EB" (1 1/4" flange). Corner trim plate is standard, smooth mitered corner furnished on special order. Roughing-in frame available if desired.

BASEBOARD GRILLE

For baseboard installations, where the grille extends above the baseboard, a special angle filler strip is furnished to snap in place behind the flange and cover the gap between the frame and the wall.



ENGINEERED AIR DISTRIBUTION

UNI-FLO Adequate, draftless air distribution can be accurately planned in advance by the use of UNI-FLO Engineering Data, which is based on the most thorough and comprehensive tests ever made on the subject of correct air distribution in enclosed spaces. A copy will be forwarded on request.

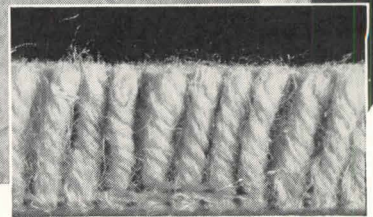
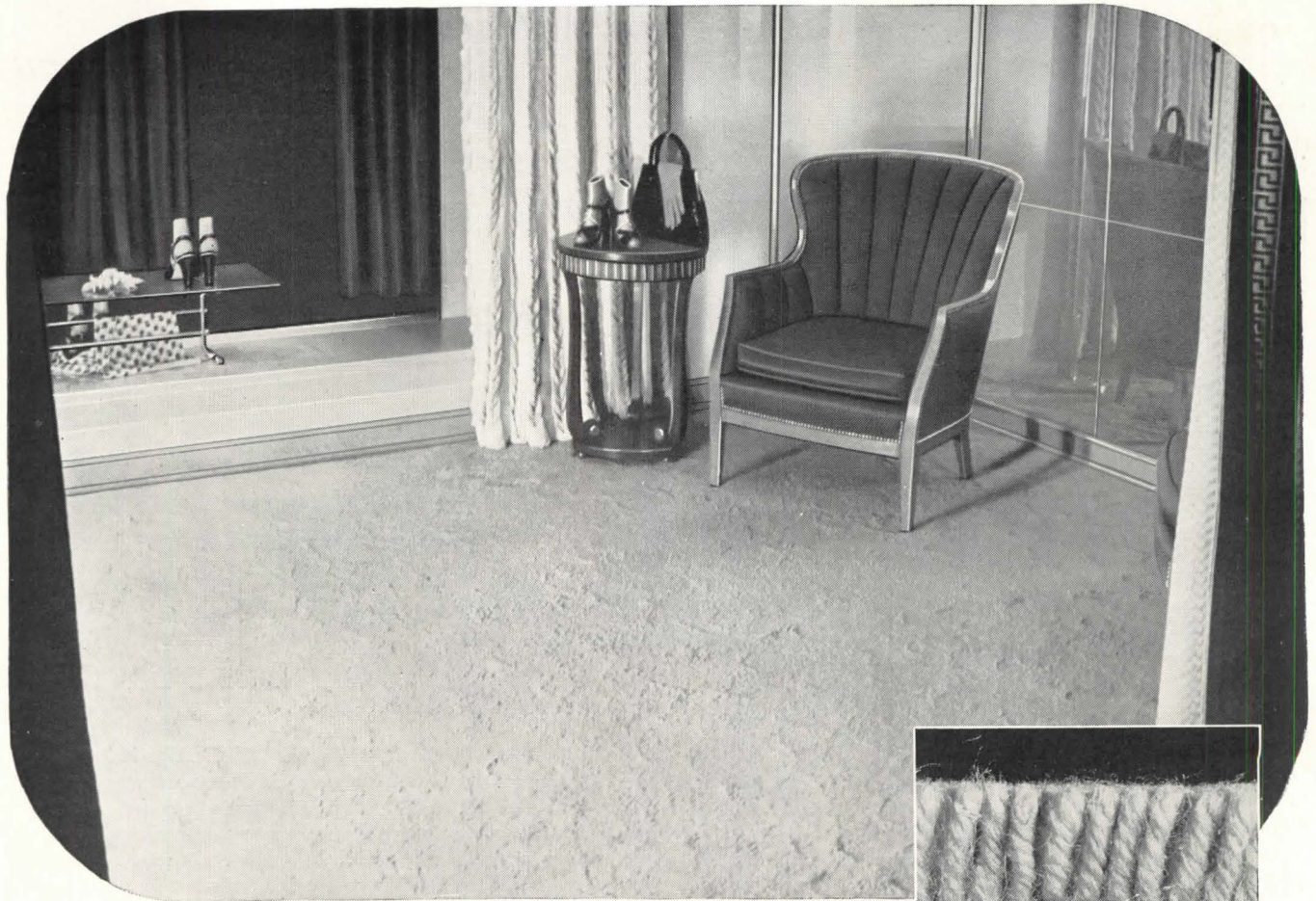
BARBER-COLMAN

COMPANY
ROCKFORD
ILLINOIS

ELECTRIC
TEMPERATURE CONTROL SYSTEMS

UNI-FLO
GRILLES AND REGISTERS

FOR FURTHER INFORMATION
SEE OUR CATALOG IN SWEET'S



Saks - FIFTH AVENUE
[BEVERLY HILLS, CALIFORNIA]

"Very Saks-Fifth Avenue" is this Bigelow Lokweave Crescendo carpet! Cross-section shows actual depth of pile.



CARPETED BY BIGELOW

In response to popular demand, Saks-Fifth Avenue opened this beautiful California store just a year ago. Business came so thick and fast that a large addition is now nearing completion.

Designed by Paul Williams, Architect, this fine store forms an ideal setting for high-style merchandise. We're proud that Bigelow Lokweave* Carpet was selected for use throughout—deep, texturous Crescendo on the main floor, Sealtwist on the second.

Many prominent stores have chosen Bigelow Lok-
*Made and installed under Collins & Aikman license

weave because it offers almost unlimited decorative possibilities—stands up under heavy traffic—makes replacement easy and inexpensive in case of damage.

Whatever your carpet problem, put it up to our Carpet Counsel experts: Contract Dept., Bigelow-Sanford Carpet Co., Inc., 140 Madison Avenue, New York.

CARPET COUNSEL



ARCHITECTURAL RECORD