

# 名古屋大学東山キャンパス建物配置図

受付は地下鉄3番出入口が直通です

インタラクティブマップ



- 建屋出入口 ↑↓
- 食堂 🍴
- カフェ ☕
- コンビニ 🏪



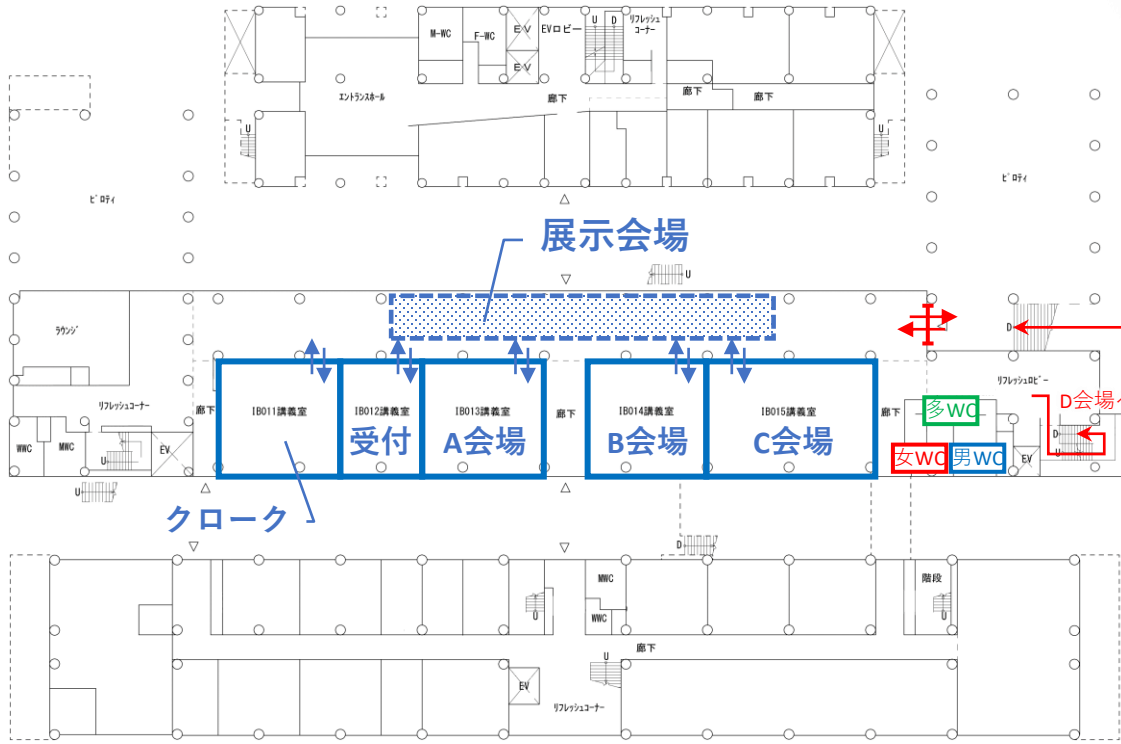
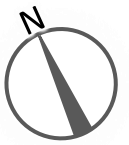

1階

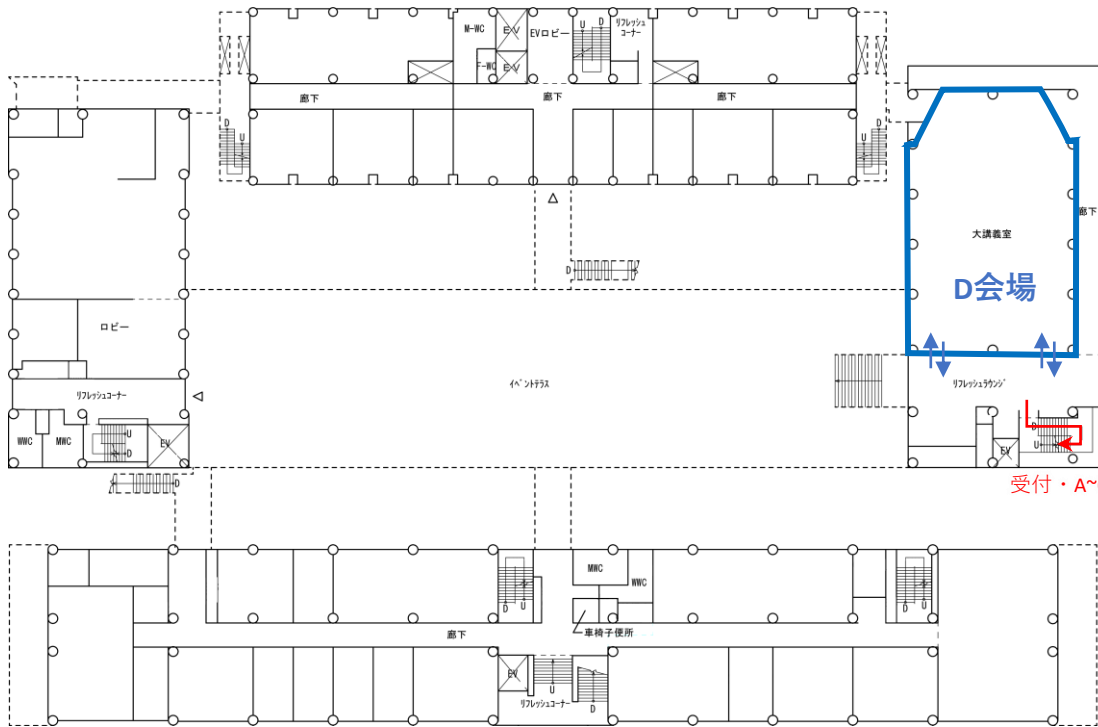

2階

# オークマ工作機械工学館

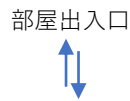

男子トイレ

女子トイレ

多目的トイレ

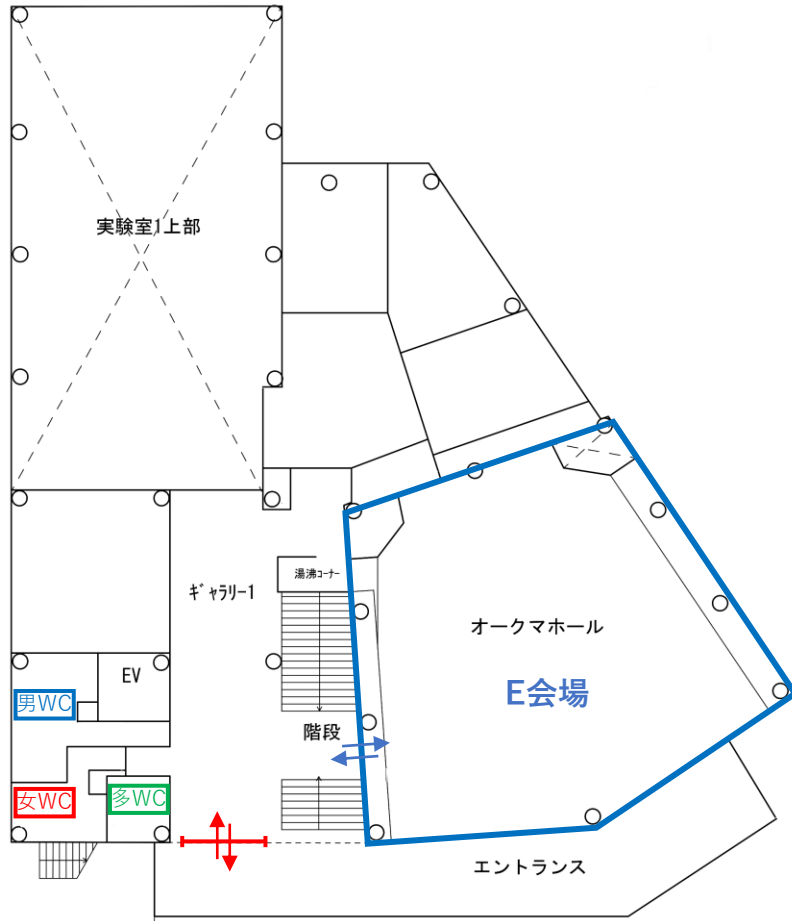

1階

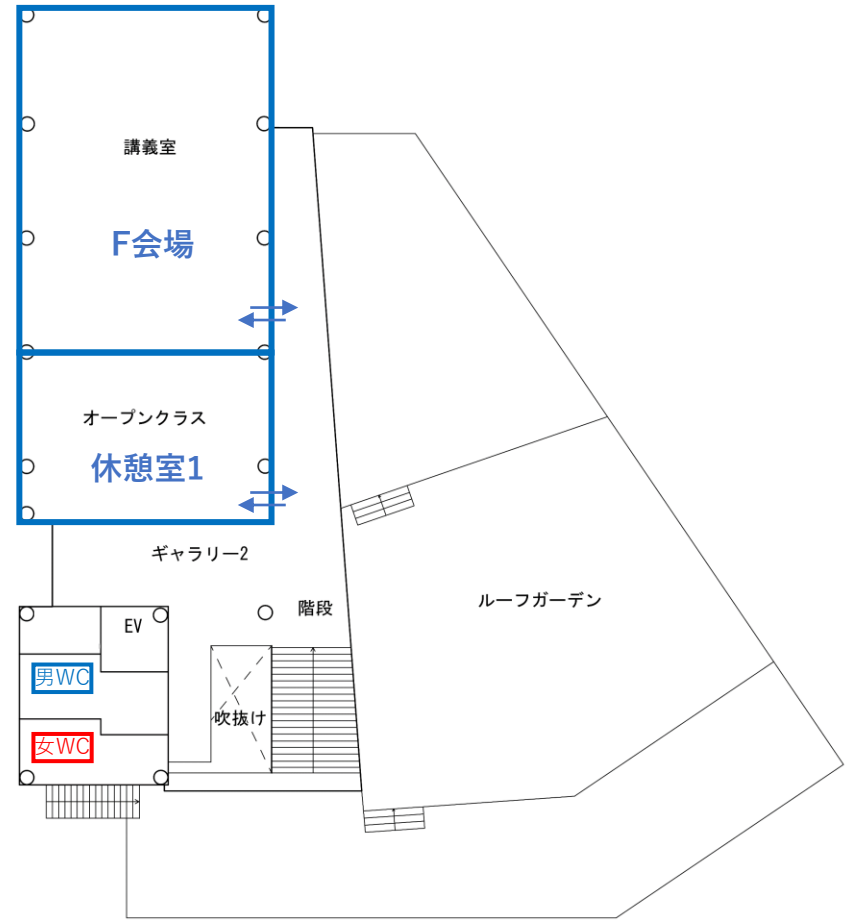

2階

# ES総合館

建屋出入口



部屋出入口



男子トイレ

男WC

女子トイレ

女WC

多目的トイレ

多WC

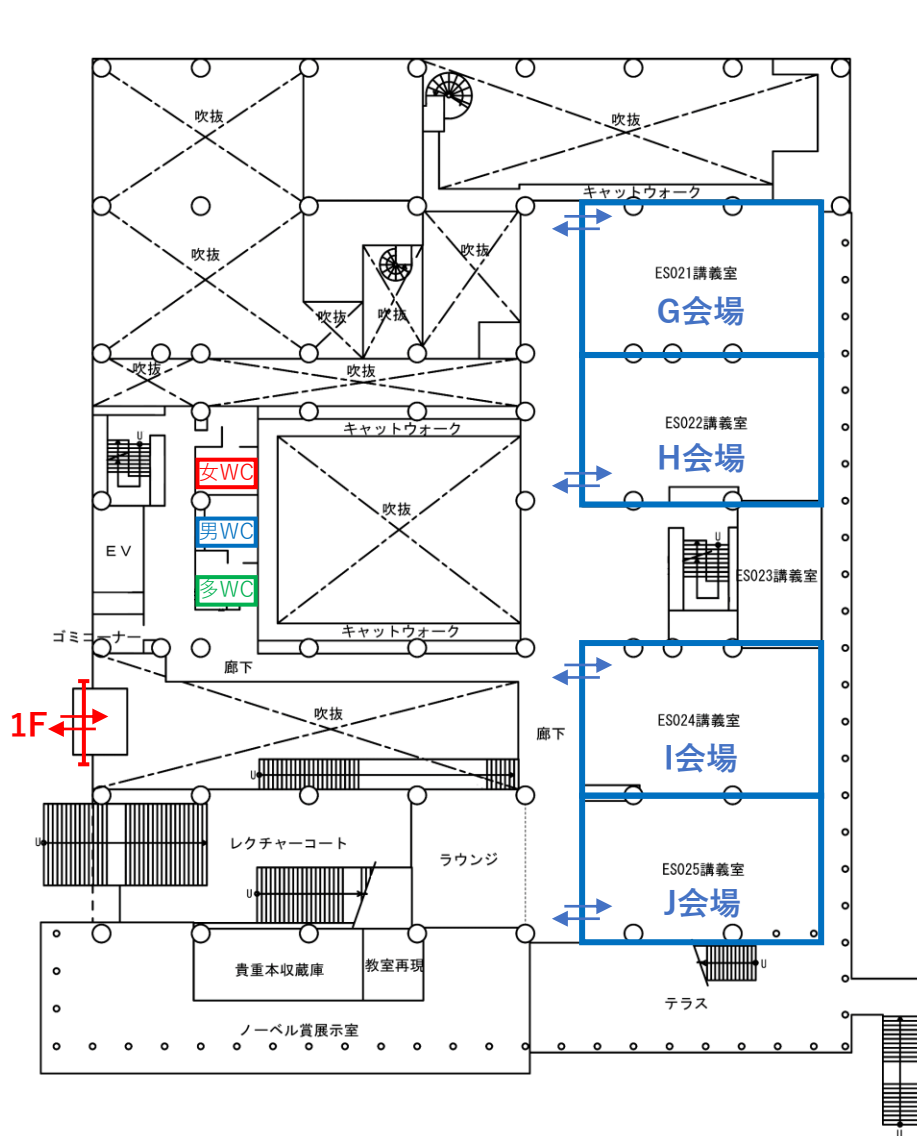

2階

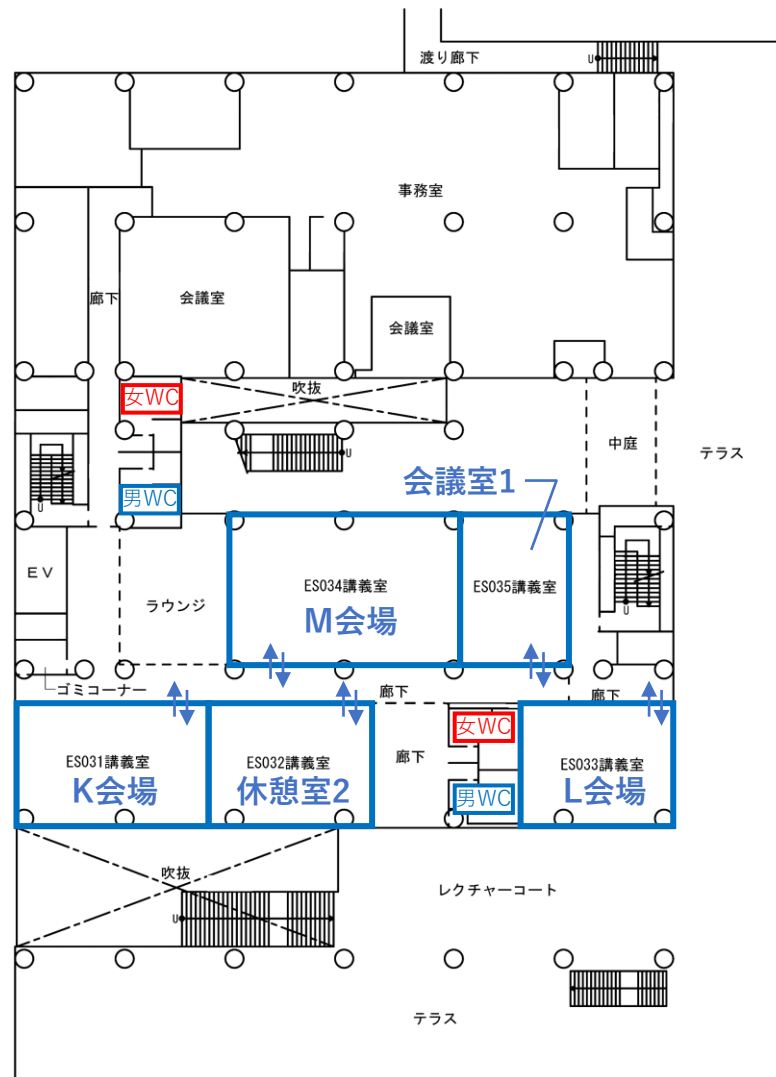

3階

# 工学部5号館

建屋出入口



部屋出入口



男子トイレ

男WC

女子トイレ

女WC

多目的トイレ

多WC

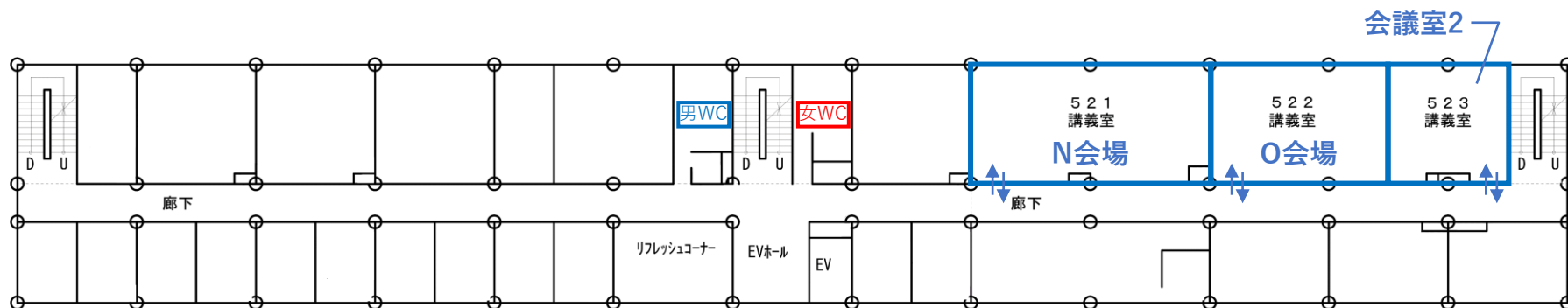

2階

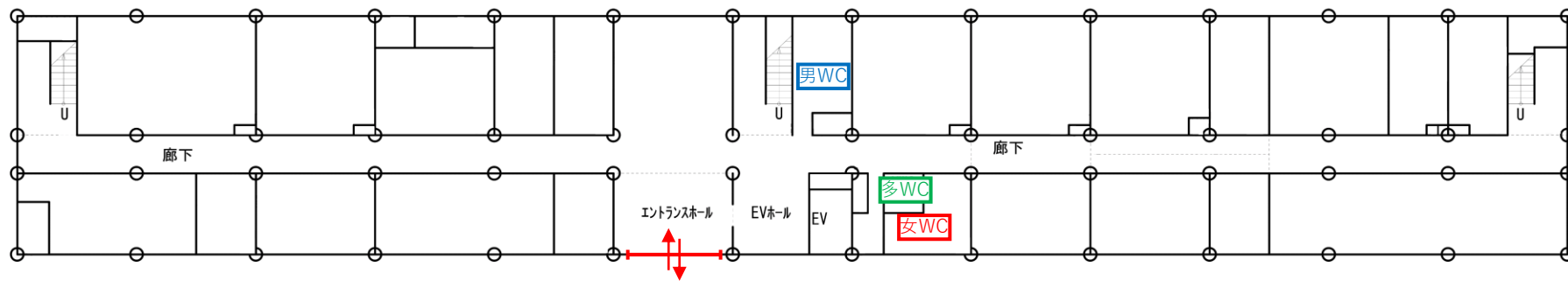

1階

