

Precise & Flexible

STRAIN GAUGES *2017*

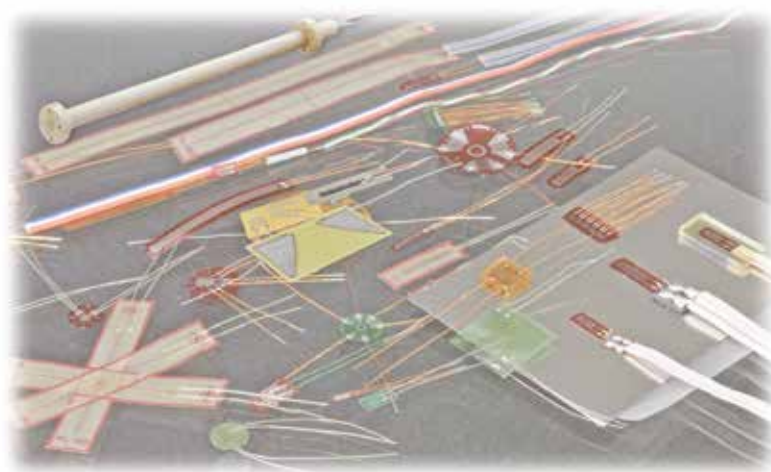
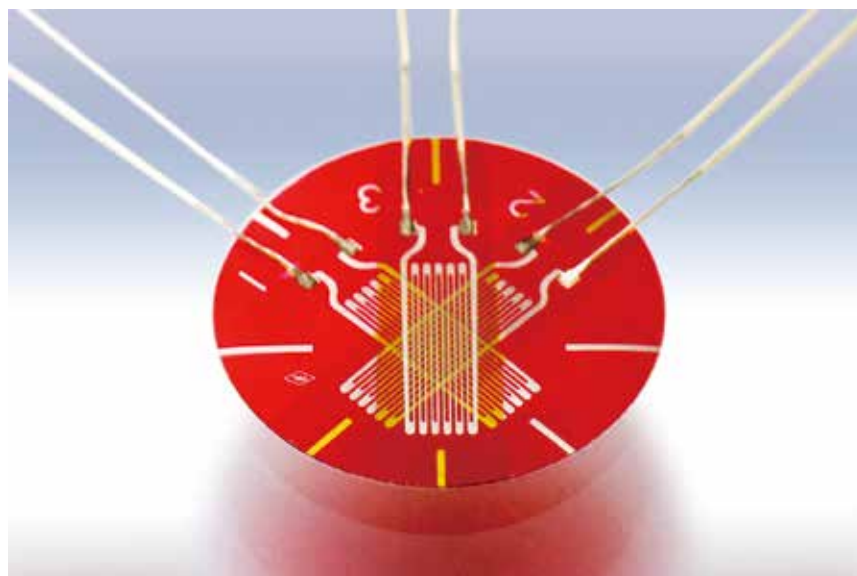

INTRODUCTION

This catalog presents the full range of TML standard strain gauges and associated products including bonding adhesives and coating materials manufactured by Tokyo Sokki Kenkyujo Co., Ltd.

TML is a registered trade mark of the company.

It also describes how to find specific strain gauges, introduces typical applications, and defines the most commonly used technical terms.

Prior to using the catalog, please check the information listed below.

CHANGES IN SPECIFICATIONS

In the interest of product improvement, the specifications in this catalog are subject to change without prior notice.

DIMENSIONS

Dimensions are mainly given in millimeter. Strain gauge patterns are shown in actual size, with enlargements of some miniature patterns.

PRICES

Prices are not listed in this catalog. For price information or orders, please contact TML or your local representative.

HANDLING STRAIN GAUGES

1. The technical data supplied herein do not reflect the influence of the leadwire. The data must be corrected in accordance with the effect caused by the leadwire.
2. The service temperature of a strain gauge depends on the operating temperature of the adhesive, etc.

3. Insulation resistance should be checked at a voltage of less than 50V.
4. Do not apply an excessive force to the gauge leads.
5. Apply adhesive to the back of the strain gauge and attach the gauge to the specimen.
6. The back of each strain gauge has been washed and degreased. Do not contaminate it by touching it directly.
7. For maintaining quality, store products in a dry place.

HANDLING BONDING ADHESIVES AND COATING MATERIALS

1. Read the operation manual carefully before using bonding adhesives and coating materials.
2. After using an adhesive, wipe all remaining adhesive off the container and nozzle with a cloth, and replace the cap.
3. After using an adhesive, put the container back in the package and store it in a cool, dark place away from fire.
4. If an adhesive contacts skin or clothing, wash well with soap and water.

If you have any questions about this catalog, please contact TML or your local representative.



TML STRAIN GAUGES

Stress measurement technologies are indispensable for ensuring the safety and efficiency of all kinds of structures. Since its founding in 1954, Tokyo Sokki Kenkyujo Co., Ltd. has been a specialized manufacturer of stress measuring instruments including strain gauges and related products. Throughout the history of more than 60 years, the company has striven to meet the needs of the times and to provide trustworthy products that can be used with full reliability.

TML Strain Gauges are our main products, and we unveiled the world's first polyester strain gauge in 1956. This new gauge brought about a great improvement in the humidity resistance of gauge backings compared to the strain gauges with paper backings which were popular at that time. Since then, our various technologies represented by the development of foil strain gauges and high temperature strain gauges have enabled reliable measurements under diverse conditions.



About this TML STRAIN GAUGES

This catalog presents the full range of TML standard strain gauges and associated products including bonding adhesives and coating materials manufactured by Tokyo Sokki Kenkyujo Co., Ltd.

It also describes how to find specific strain gauges, introduces typical applications, and defines the most commonly used technical terms.

Each strain gauge series includes its operating temperature and temperature compensation range along with the bar images as shown right.

Each strain gauge series is available with different bonding adhesives. Operating temperature is given along with combination of applicable adhesive, while it may differ from potential temperature of the adhesive itself.

Operating temperature range



Temperature compensation range



Compatible adhesive & Operating temperature

CN : 0 ~ +80°C
P-2 : -20 ~ +80°C

Each strain gauge series is designed for object materials. 14 different materials are shown with pictograms.

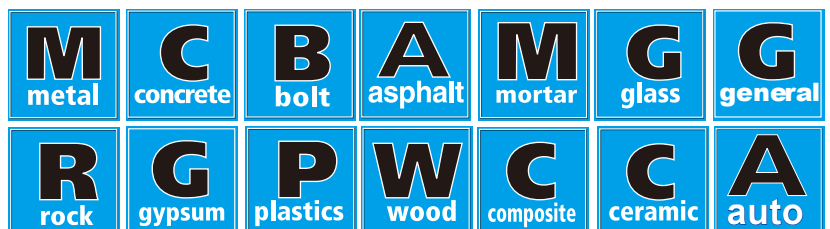

TML STRAIN GAUGE TESTING AND INSPECTION STANDARDS

TML strain gauges are manufactured under a fully integrated system that covers all stages from development to tests and inspections, and the utmost attention is paid to quality management in all processes. Our strain gauges, which we manufacture in the cleanest environment using the best materials available, are tested and inspected according to international standards, most notably NAS942, the National Aerospace Standard.

TML Strain gauges Testing and Inspection Standards

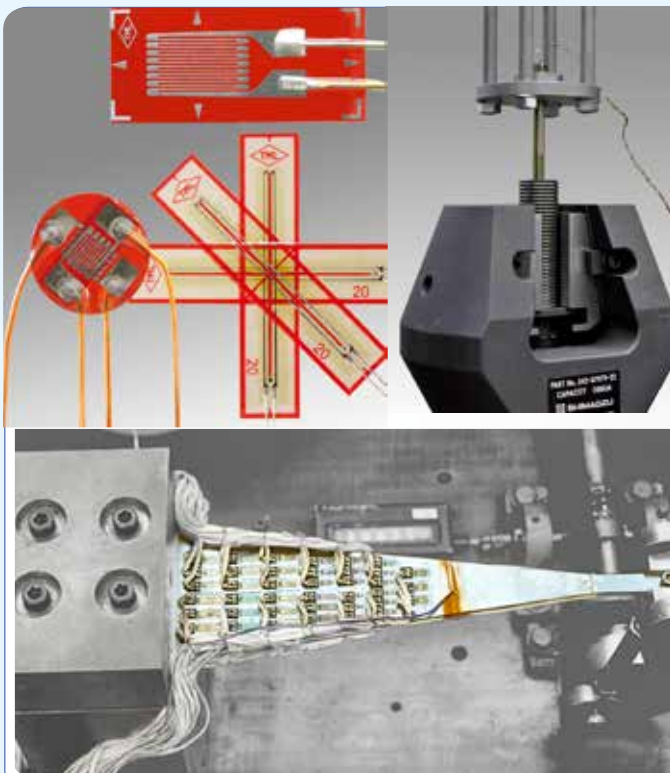

Testing and Inspection Standards

- ¶ Visual and Microscopic Inspections
TML Inspection Procedures and Standards
- ¶ Gauge Resistance
TML Procedures and Inspection Standards
- ¶ Gauge Factor
ASTM E251, NAS942 and BS6888
- ¶ Transverse Sensitivity
ASTM E251 and NAS942
- ¶ Temperature Coefficient of Gauge Factor
ASTM E251 and NAS942
- ¶ Thermal Output
ASTM E251 and NAS942
- ¶ Strain Limits
NAS942
- ¶ Fatigue Life
NAS 942
- ¶ Creep
NAS942
- ¶ Drift
NAS942

Principal standards used for strain gauge calibration and standard test methods

- ¶ ASTM E251-74
"Standard Test Methods for Performance Characteristics of Metallic Bonded Resistance Strain Gauges"
Designation: E251-92, ASTM
- ¶ BSI BS6888
"Methods for Calibration of Bonded Electric Resistance Strain Gauges"
Draft for development 6:1972. BSI
- ¶ NAS942
"Strain Gauges, Bonded Resistance"
Classification Specification NAS 942, 1963
- ¶ VDE/VDI Richtlinien NR 2635
"Bonded Electric Resistance Strain Gauges with Metallic Measurement Grids - Characteristics and Testing Conditions"
VDE/VDI-Richtlinien NR 2635 August, 1974
- ¶ Other standards
JIS Z2300-91 - "Glossary of Terms Used in Nondestructive Testing", Japan Industrial Standard
NDIS 4001:2008 - "Glossary of Terms Relating to Electric Resistance Strain Gauges", NDI, Japan

TABLE OF CONTENTS

Table of contents

TML Strain Gauge Applications	5
General Description	7
Technical Terms	9
Strain Gauge Measurement	11
Measuring method of strain and temperature	15
TML Foil Strain Gauges F series GOBLET compliant to CE marking	16
Strain Gauge Bridge Circuit	17
TML Strain Gauge Coding System/ Package Designation	21
TML Strain Gauge Selection	25
Primary Installation Bonding/Overcoating	31
Strain Gauge Extension Leadwires	33
How are integral leadwires jointed.....	35
Strain Gauge Installation	39
Strain Gauge Tool Kit	40
Strain Gauge Users' Guide / Strain Gauge Performance Characteristics	40
Combination use of strain gauges and dedicated leadwires.....	41
General use strain gauges F series	43
General use strain gauges F series GOBLET compliant to CE marking	48
Waterproof strain gauges WF series	52
High temperature strain gauges QF series	53
High temperature strain gauges ZF series	55
High temperature strain gauges EF series	56
High and Low temperature strain gauges CEF series	56
Cryogenic temperature strain gauges CF series.....	57
Weldable strain gauges AW series	59
Spot Welder W-50RB	64
Concrete material use	
Bondable type P series, PF series	65
Bondable type FLM/WFLM series, Embedment type PM series	66
Embedment type PMF series	68
Asphalt Pavement use	
Embedment type PMFLS series	68
Concrete material use/Civil Engineering	
Strain Transducer KM series	69
Asphalt pavement use/Civil Engineering	
Strain Transducer KM-HAS series	70
Composite materials use UBF series, BF series.....	71
Low elastic modulus materials use GF series	72
Wood materials LF series, PFLW / PLW series	73
Magnetic field strain gauges MF series	74
Post-Yield Strain gauges YEF series, YF series, YHF series	75
High endurance Strain Gauges DSF series, One-side Strain Gauges DD series	78
Crack Detection Gauges FAC series, Stress Gauges SF series	79
Temperature Gauges TF series, Platinum RTD/ Thermocouple	80
Transducer-specific Strain Gauges	81
Bolt Strain Gauges BTM series, BTMC series	83
Connecting Terminals	85
Strain Gauge Clamp Gauge Mate / Pressee	86
Strain Gauge Adhesives	87
Coating Materials	89
Gauge Protector, Coating Tape	91
Frictional Axial Strain Transducer FGAH-1B series	92
Frictional Torque Sensor System FGDH series	93
Frictional Strain Checker FGMH series	95
TML Strain Measuring Instruments	97

TML STRAIN GAUGE APPLICATIONS

Miniature strain gauges

Printed circuit boards and surface mounting parts of automobile, computers and industrial machinery are getting smaller. Miniature strain gauges can be installed in a very limited gauge installation space.

Strain gauges in the valley of gear

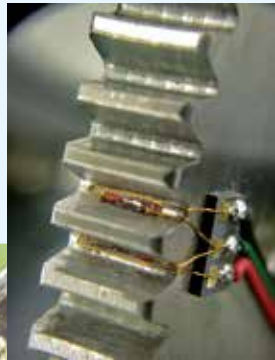

Strain gauges on printed circuit board



10-element chain type strain gauges on bolt head



Shearing strain and torque measurements

Shearing strains in 45-degree direction generated by shearing stress.

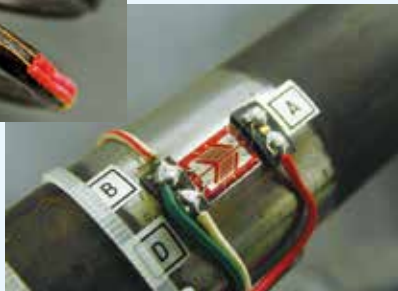

Residual stress measurement

3-element residual stress measurement by center-hole drilling method

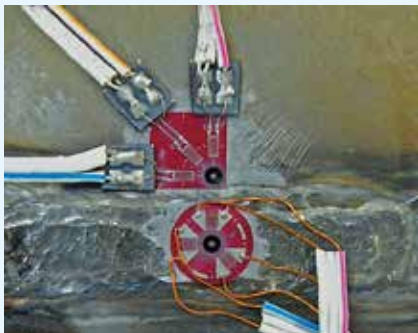

Magnetic field use

Strain Gauge single element and twisted leadwire



Strain Gauge 0°/45°/90° 3-element and FEP twisted leadwire



Strain measurement less influenced by EM noise between pantograph and trolley wire of electrified railway system

Railway axle load measurement



Concrete/Mortar measurements

Surface strain measurement of concrete and mortar

Strain Gauge with longer gauge length for concrete surface

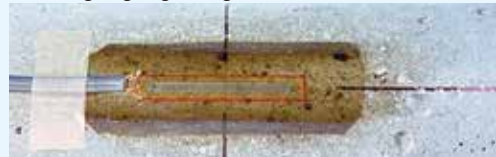

Strain Gauges with longer gauge length and metal backing for concrete surface

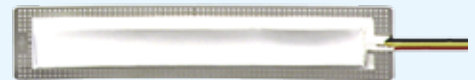

Internal strain measurement of concrete and mortar

Mold strain gauges

PM series



PMF series available with temperature sensor integrated



Internal strain measurement of concrete for long term



Full bridge Strain Transducer KM series

Before placement of concrete, 3 KM transducers are installed to reinforcing bars.



TML STRAIN GAUGE APPLICATIONS

Bolt tensile force by embedment type gauges

For measurement of tensile strain in a bolt. Simply inserted into a pre-drilled hole in the bolt head together with bonding adhesive. BTM and BTMC gauge series are recommendable if an ordinary strain gauge cannot be mounted on the bolt surface. Accurate tensile force measurement is possible by calibrating the bolt after installing the bolt gauges.



Weldable strain gauges

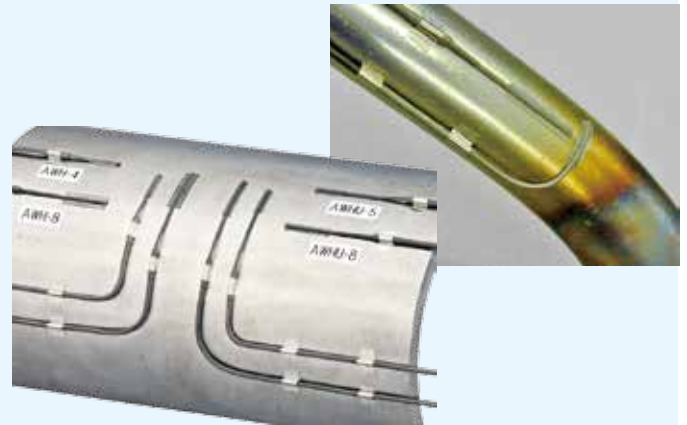

Frictional Strain Checker, Axial Strain Transducer, Torque Sensor System

Strain Checker FGMH series for single and 3-directional measurement. Re-usable with installation by magnet.



Torque Sensor System FGDH series applicable to driving shaft with split and cover-up system. With built-in telemetry transmitter, no wiring is required.



Split and cover-up system



Axial Strain Transducer FGAH series applicable to steering shaft with cover-up system. Different from the above FGDH, wire connection is required.



High Endurance Strain Gauge bonded on composite materials



Composite materials on which High Endurance Strain Gauge DSF is bonded are demonstrated for fatigue test over 10^7 cycles at strain level of $\pm 3,000$ microstrain.

FBG Fiber-optic Strainmeter

Designed for Fiber Bragg Grating based strain gauges with optic fiber

- Temperature-compensation available with our FBG sensor
- No effect by EM noise
- Long distance measurement
- Fiber branching due to WDM techniques



Long term measurement

For construction measurement and maintenance.



GENERAL DESCRIPTION

Strain gauges are generally used for one of three reasons:

- To ascertain the amount of deformation caused by strain
- To ascertain the stress caused by strain and the degree of safety of a material or of a structural element that uses that material.
- To indirectly ascertain various physical quantities by converting them to strain.

There are a number of ways of measuring strain mechanically and electrically, but the vast majority of stress measurement is carried out using strain gauges due to their superior measurement characteristics.

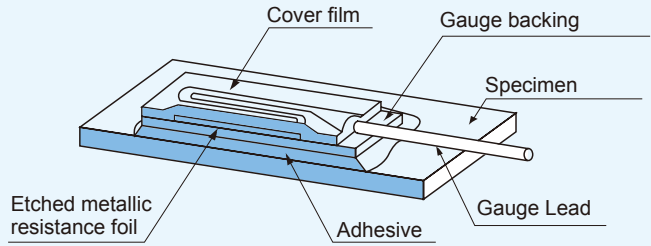

What is Strain?

External force applied to an elastic material generates stress, which subsequently generates deformation in the material. At this time, the length of the material L extends to $L+\Delta L$ if the applied force is a tensile force. The ratio of ΔL to L , that is $\Delta L/L$, is called strain. On the other hand, if a compressive force is applied, the length L is reduced to $L-\Delta L$. Strain at this time is $(-\Delta L/L)$.

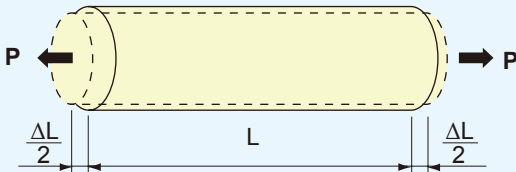

$$\epsilon = \frac{\Delta L}{L} \quad \text{where} \quad \begin{array}{l} \epsilon : \text{Strain} \\ L : \text{Original length of material} \\ \Delta L : \text{Change in length due to force P} \end{array}$$

Example) when a material of 100mm long deforms by 0.1mm in its length, the resulting strain is as follows.

$$\epsilon = \frac{\Delta L}{L} = \frac{0.1}{100} = 0.001 = 1000 \times 10^{-6}$$

What is a Strain Gauge?

The electric resistance of a metal changes proportionally to the mechanical deformation caused by an external force applied to the metal. By bonding a thin metal to a measurement object through a thin electrical insulator, the metal deforms depending on deformation of the measurement object and its electric resistance changes. The strain gauge (electric resistance strain gauge) is a sensor to measure the strain by means of measuring the resistance change.

Strain Gauge Configuration

A strain gauge is constructed by forming a grid made of fine electric resistance wire or photographically etched metallic resistance foil on an electrical insulation base (backing), and attaching gauge leads.

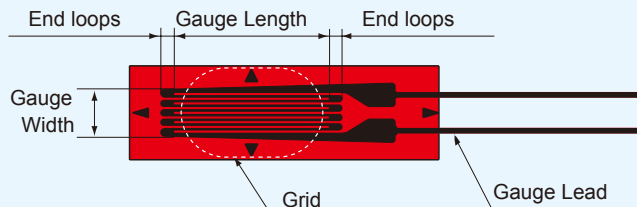

Strain Gauge Principles

When strain is generated in a measurement object, the strain is transferred to the resistance wire or foil of the strain gauge via the gauge base (backing). As a result, the wire or foil experiences a resistance change. This change is exactly proportional to the strain as in the equation below.

$$\epsilon = \frac{\Delta L}{L} = \frac{\Delta R}{R} = \frac{1}{K}$$

where

- ϵ : Strain measured
- L : Original length of material
- ΔL : Change in length due to force P
- R : Gauge resistance
- ΔR : Resistance change due to strain
- K : Gauge Factor as shown on package

Normally, this resistance change is very small and requires a Wheatstone bridge circuit to convert the small resistance change to a more easily measured voltage change.

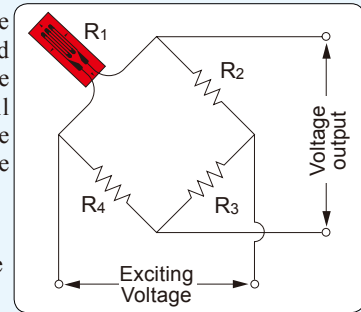

The voltage output of the circuit is given as follows.

$$e = \frac{R_1 R_3 - R_2 R_4}{(R_1 + R_2)(R_3 + R_4)} E$$

where

- e : Voltage output
- E : Exciting voltage
- R_1 : Gauge resistance
- $R_2 \sim R_4$: Fixed resistance

Here, if $R=R_1=R_2=R_3=R_4$ the resistance of the strain gauge changes to $R+\Delta R$ due to strain. Thus, the output voltage Δe (variation) due to the strain is given as follows.

$$e = \frac{\Delta R}{4R + 2\Delta R} E$$

When $\Delta R \ll R$,

$$\Delta e = \frac{\Delta R}{4R} E = \frac{E}{4} K \epsilon$$

When measuring with a strain gauge, it is connected to an instrument called a strainmeter. The strainmeter configures a Wheatstone bridge circuit and supplies exciting voltage. Measured strain is indicated on a digital display and/or output as analog signals.

Plane Stress and Strain

The stress in a material balanced with an applied external force can be considered a combination of more than one simple stress. In other words, these stresses can be divided into simple stress in the respective axial directions; however, measurement with ordinary strain gauges is restricted to the plane strain. In case that the stress exists in uniaxial direction like tension of a bar illustrated below, the following equation are applicable.

$$\varepsilon_x = \frac{\sigma}{E}$$

$$\varepsilon_y = -\nu\varepsilon_x = -\frac{\nu\sigma}{E}$$

where

σ : Stress
 E : Elastic modulus
 ε_x : Strain in x direction
 ε_y : Strain in y direction
 ν : Poisson's ratio

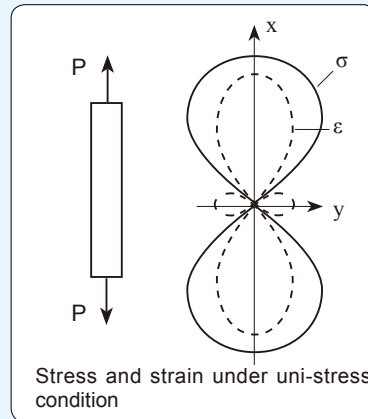

The biaxial stresses generated by pulling the bar in both normal and transversal directions are:

$$\varepsilon_x = \varepsilon_x' - \nu\varepsilon_y'$$

$$= \frac{\sigma_x}{E} - \frac{\nu\sigma_y}{E}$$

$$= \frac{1}{E} (\sigma_x - \nu\sigma_y)$$

$$\varepsilon_y = \varepsilon_y' - \nu\varepsilon_x'$$

$$= \frac{\sigma_y}{E} - \frac{\nu\sigma_x}{E}$$

$$= \frac{1}{E} (\sigma_y - \nu\sigma_x)$$

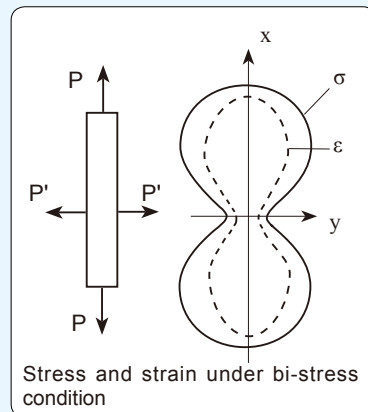

ε_x' : strain in the x direction due to σ_x

ε_y' : strain in the y direction due to σ_y

$$\sigma_x = \frac{E}{1-\nu^2} (\varepsilon_x + \nu\varepsilon_y)$$

$$\sigma_y = \frac{E}{1-\nu^2} (\varepsilon_y + \nu\varepsilon_x)$$

For the stress in other than the crossed biaxial directions, it is shown according to its angle as follows.

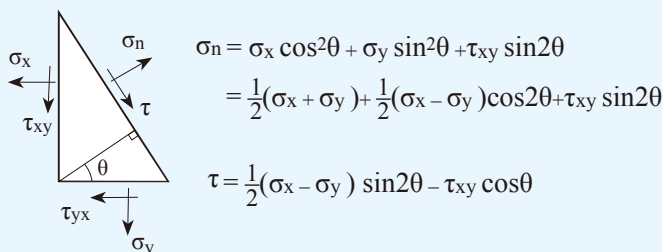

As noted from the above equations, in a certain direction, the maximum value of the resultant stress appears in the uniaxial direction. The axial direction is called a principal direction of stress and the stress in that direction a principal stress. In this direction, the shearing stress is zero. The maximum value of shearing stress is generated in the direction of 45° against the principal direction of stress. It can also be applied to the strain. The strain in such a direction is called a principal strain.

Measurement of principal strain and stress using 3-element rectangular rosette gauge

When strain is generated in the surface of material and the principal direction of the strain and its extent are unknown, the principal strain, stress and their directions and shearing strain and stress can be obtained by measuring the strains in three directions over the surface. In order to simplify calculation, the relative angle in the three directions are determined as follows.

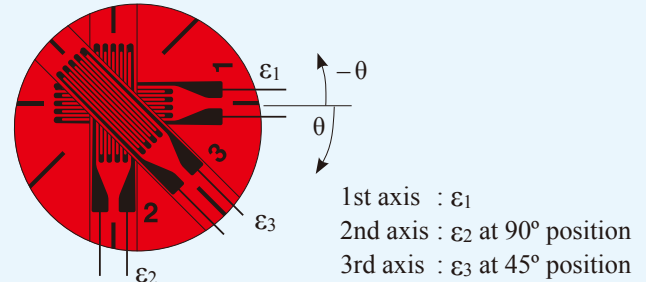

Maximum principal strain

$$\varepsilon_{\max} = \frac{1}{2} [\varepsilon_1 + \varepsilon_2 + \sqrt{2\{(\varepsilon_1 - \varepsilon_3)^2 + (\varepsilon_2 - \varepsilon_3)^2\}}]$$

Minimum principal strain

$$\varepsilon_{\min} = \frac{1}{2} [\varepsilon_1 + \varepsilon_2 - \sqrt{2\{(\varepsilon_1 - \varepsilon_3)^2 + (\varepsilon_2 - \varepsilon_3)^2\}}]$$

Maximum shearing strain

$$\gamma_{\max} = \sqrt{2\{(\varepsilon_1 - \varepsilon_3)^2 + (\varepsilon_2 - \varepsilon_3)^2\}}$$

Angle from ε_1 gauge to direction of principal strain

$$\theta = \frac{1}{2} \tan^{-1} \left\{ \frac{2\varepsilon_3 - (\varepsilon_1 + \varepsilon_2)}{\varepsilon_1 - \varepsilon_2} \right\}$$

If $\varepsilon_1 > \varepsilon_2$, the angle to the maximum principal strain is rotated by θ clockwise from the 1st axis, and the minimum principal strain is located at $\theta + 90^\circ$. If $\varepsilon_1 < \varepsilon_2$, the angle to the maximum principal strain is rotated by $\theta + 90^\circ$ clockwise from the 1st axis, and the minimum principal strain is located at θ .

Maximum principal stress

$$\sigma_{\max} = \frac{E}{1-\nu^2} (\varepsilon_{\max} + \nu\varepsilon_{\min})$$

$$= \frac{E}{2} \left[\frac{\varepsilon_1 + \varepsilon_2}{1-\nu} + \frac{1}{1+\nu} \sqrt{2\{(\varepsilon_1 - \varepsilon_3)^2 + (\varepsilon_2 - \varepsilon_3)^2\}} \right]$$

Minimum principal stress

$$\sigma_{\min} = \frac{E}{1-\nu^2} (\varepsilon_{\min} + \nu\varepsilon_{\max})$$

$$= \frac{E}{2} \left[\frac{\varepsilon_1 + \varepsilon_2}{1-\nu} - \frac{1}{1+\nu} \sqrt{2\{(\varepsilon_1 - \varepsilon_3)^2 + (\varepsilon_2 - \varepsilon_3)^2\}} \right]$$

Maximum shearing stress

$$\tau_{\max} = \frac{E}{2(1+\nu)} \gamma_{\max}$$

$$= \frac{E}{2(1+\nu)} \sqrt{2\{(\varepsilon_1 - \varepsilon_3)^2 + (\varepsilon_2 - \varepsilon_3)^2\}}$$

NOTE:

The above rosette analysis equations are based on the 3-element strain gauge shown in the diagram. When the order of the axis numbers is different or when the gauge is not a 90° rosette gauge, different equations must be used. Check the axis numbers of applicable strain gauge before performing rosette analysis.

TECHNICAL TERMS

Gauge Length

This dimension represents the actual grid length in the sensitive direction.

Gauge Resistance

The gauge resistance is the electrical resistance of an unbonded gauge at room temperature and subject to no external stress. The gauge resistance generally used is 120Ω but gauges are also produced with gauge resistance of 60Ω, 350Ω and 1000Ω. High-resistance gauges yield a high bridge output when high voltages are applied but they are also susceptible to noise. The majority of the strain gauges used in the production of transducers have a gauge resistance of 350Ω.

Gauge Factor

The amount shown in the following equation is called the gauge factor. In this equation, ε indicates the strain generated due to uniaxial stress in the direction of the strain gauge axis. ΔR/R shows the ratio of resistance change due to strain ε.

$$K = \frac{\Delta R / R}{\epsilon}$$

where

- K : Gauge Factor
- ε : Mechanical strain
- R : Gauge Resistance
- ΔR : Resistance change

Longitudinal Sensitivity

Longitudinal sensitivity is very similar to the gauge factor and refers to the sensitivity of the gauge when no strain is applied in the direction perpendicular to the gauge axis.

Transverse Sensitivity

The gauge also exhibits sensitivity in the direction perpendicular to the axial direction. The amount shown in the following equation due to the uniaxial strain (εt) in the direction perpendicular to the gauge axis, and the resistance variation generated thereby, is called transverse sensitivity (Kt).

$$K_t = \frac{\Delta R / R}{\epsilon_t} \times 100$$

where

- Kt : Transverse Sensitivity
- εt : Uniaxial strain perpendicular to the gauge axis

Transverse Sensitivity Ratio

This refers to the ratio of transverse sensitivity to longitudinal sensitivity. This is usually 1% or less and does not usually pose a problem except in high-precision measurement or in locations with biaxial strain.

Gauge Hysteresis

When a strain gauge is bonded to a test specimen and strain is applied, resistance change for identical strain in increase and decrease processes may differ. This difference is referred to as hysteresis. Gauge hysteresis varies depending on factors such as grid configuration, base material, adhesive and temperature.

Thermal Hysteresis

Thermal hysteresis refers to hysteresis that occurs in the heating or cooling cycle such that the respective cycles do not pass through the same point. Thermal hysteresis poses an ongoing problem in strain measurement where temperature

change occurs. This hysteresis must be removed by applying heat treatment to stabilize the characteristic of the strain gauge and the adhesive.

Gauge Zero Drift with Temperature

At high temperature, effects such as thermal oxidation of the sensing elements in a strain gauge cause the zero point of the gauge in a no-load state to gradually drift. This is one of the characteristics that determine a strain gauge's resistance to heat. Above 200°C, Ni-Cr alloy performs far better than Cu-Ni alloy, and alloys such as Pt-W are used in 500°C to 800°C environments.

Self-Temperature-Compensated Gauges

A change in the ambient temperature may cause a variation of strain gauge resistance. The variation is ascribable to the thermal expansion of both strain gauge material and specimen, together with the thermal coefficient of resistance of the gauge material. Self-temperature compensated gauges are commonly used to minimize the gauge thermal output when bonded to test specimens having a specific linear thermal expansion coefficient in the specified temperature range. The following graph shows an example of thermal output.

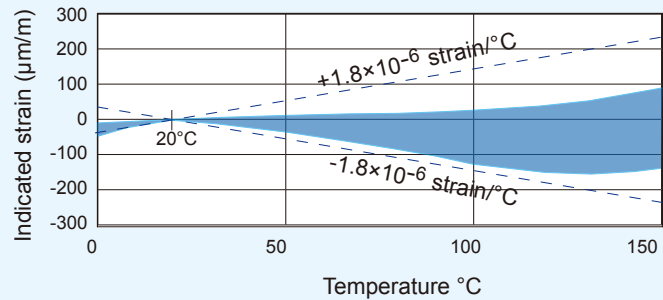

Temperature Compensation Range

This refers to a temperature range in which the thermal output of a self-temperature compensated gauge should be within the given range. Compensation is accurate within approximately ±1.8×10⁻⁶ strain/°C. For greater accuracy, corrections can be made using the curves for apparent strain vs. temperature which is supplied with each package of gauge.

Operating Temperature Range

This range is the temperature range within which a strain gauge can be used continuously under appropriate conditions. The figure below shows thermal output characteristics for Cu-Ni and Ni-Cr alloys used for the sensing elements in TML strain gauges. Most strain gauges use Cu-Ni alloy, while Ni-Cr alloy is used in strain gauge series that have a wider operating temperature range.

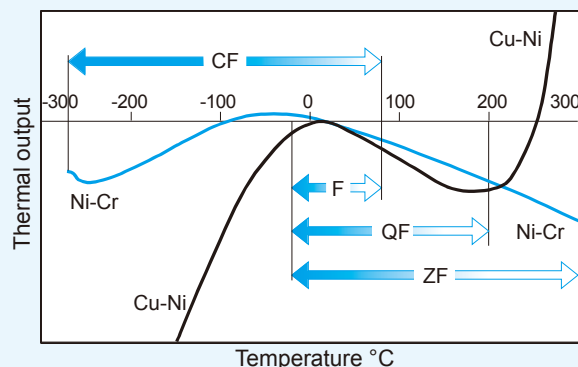

Gauge Length Selection

Different gauge lengths should be selected depending on specimens. Gauges with short gauge lengths are used to measure local strain, while gauges with long lengths can be used to measure averaged strain over a larger area. For a heterogenous material, a gauge length is required that can average out irregular strain in the material. For example, as concrete is composed of cement and aggregate (gravel or sand, etc.) the length of a gauge used is more than three times the diameter of the aggregate so as to give an averaged evaluation of the concrete.

Gauge length (mm)	Gauge Applications
0.2 ~ 1	For stress concentration measurement
2 ~ 6	For metal and general use
10 ~ 20	For mortar, wood, FRP, etc.
30 ~ 120	For concrete

Strain Limit

The strain limit is the maximum amount of strain under which a strain gauge can operate under a given condition without suffering damage. At TML, the strain limit is the smallest value of mechanical strain at which the indicated strain exceeds the mechanical strain by 10%.

General use strain gauge
F series : FLA-5-11

Post-Yield strain gauge
YF series : YFLA-5

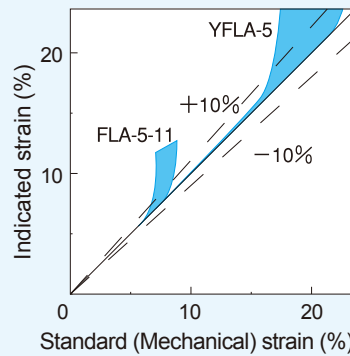

Fatigue Life

When strain is applied repeatedly to a strain gauge, as the amount of strain becomes large, the gauge resistance increases and disconnection or peeling-off of the gauge occurs to make the gauge useless. In general, the fatigue life is determined by the amount of applied strain and speed of cyclic loading and expressed by the number of repetitions. At TML, a constant mechanical strain is applied repeatedly to the bonded strain gauge and the fatigue life is indicated by the number of repetitions at which the indicated strain value without load exceeds 100×10^{-6} strain. A typical calibration result is shown below. Even if the number of repetitions exceeds the specified life, the gauges will not necessarily fail. The fatigue life of most TML gauges under a cyclic strain of $\pm 1,500$ is between 10^6 and 10^7 cycles. Under cyclic strain of less than 500, the fatigue life of most gauges is infinite. Post-yield strain gauges should not be subjected to cycle loading at strain levels near their strain limit.

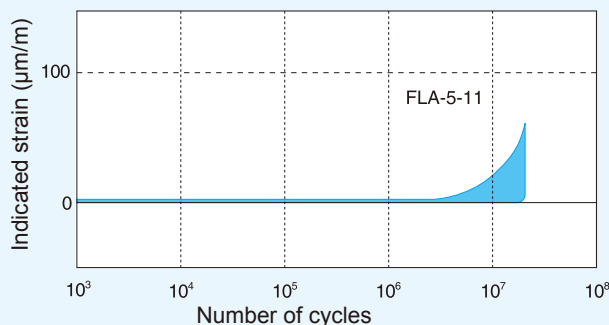

Permissible Current (Permissible Voltage)

The current flowing in a strain gauge is related to the output voltage of the gauge bridge, and the larger the current, the larger the voltage is obtained. However, depending upon the material of a specimen and the area of the gauge, Joule's heat is generated by the current to raise the temperature of gauge and as a result apparent strains are produced. In general, a current less than 30mA is recommended for metallic specimens and less than 10mA for wooden and plastic specimens which dissipate heat less efficiently.

Strain Gauge Frequency Response

The frequency response of a strain gauge is determined by the gauge length and the longitudinal elastic wave speed of the test specimen. Frequency response limits are typically only a concern under impact conditions.

Gauge length (mm)	0.2	1	3	5	10	30	60
Steel [kHz]	660	530	360	270	170	-	-
Concrete [kHz]	-	-	-	-	120	50	20

Gauge Creep

A bonded strain gauge subjected to a constant strain will give a decreasing indicated value as time progresses. This phenomenon is referred to as creep. In general, the shorter the gauge length, the greater the gauge creep becomes. Also, this tendency exhibits well if the strain gauge or adhesive absorbs moisture.

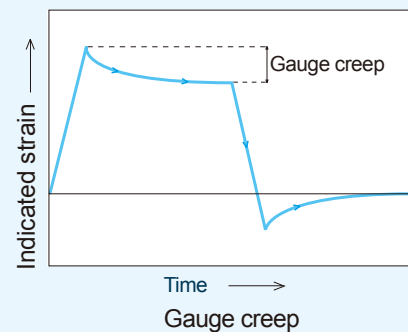

STRAIN GAUGE MEASUREMENT

Temperature compensation for leadwires in Quarter bridge

For strain gauge measurement, the Wheatstone bridge circuit is used to convert resistance change of the strain gauge into voltage output. The simplest bridge method is a quarter bridge, where one arm is composed of the strain gauge while the other three arms are composed of fixed resistors in the instrument. A 2-wire leadwire may be used for connecting the strain gauge to the instrument. However, if the temperature of the leadwire changes, thermal output of the bridge is caused even if there is no change in actual strain. For this reason, the quarter bridge 2-wire method should be used only when temperature change is not expected during the measurement or for a dynamic measurement in which the thermal output can be disregarded. A quarter bridge 3-wire method is available as a mean to eliminate the thermal output of the leadwire, when a 3-wire leadwire is used for connection of the strain gauge. In this method, the influence of resistance change of the leadwire caused by temperature change is cancelled. In addition, the effect of the leadwire on gauge factor is half as large as that of the quarter bridge 2-wire method. The quarter bridge 3-wire method is recommended over the 2-wire method, especially when temperature change is expected during the measurement and/or comparatively long leadwires are used. Other bridge methods including half bridge and full bridge are also available. Refer to p.17~20 for details.

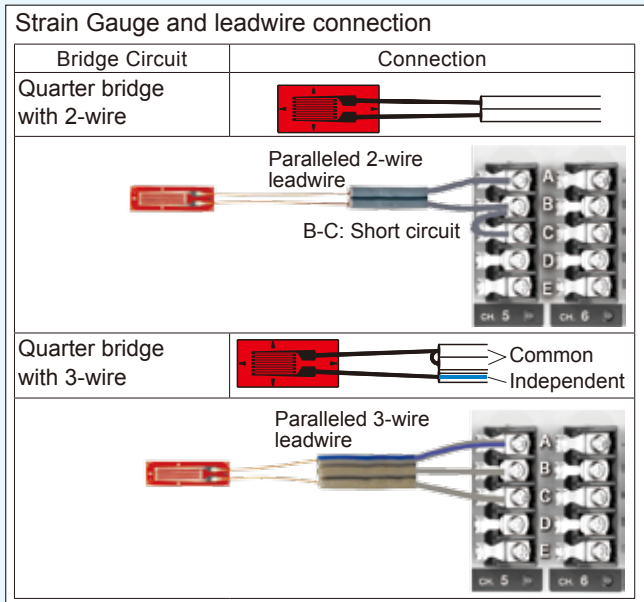

Thermal output caused by temperature change

In a quarter bridge 2-wire method, changes in leadwire temperature cause changes in the leadwire resistance, which result in thermal output. Use the equation below to compensate for this thermal output.

$$\text{Leadwire thermal output } \varepsilon L = \frac{r \cdot L \cdot \alpha \cdot \Delta T}{K \cdot (R + r \cdot L)}$$

where

- εL : Leadwire thermal output
- K : Gauge factor indicated on the strain gauge package
- α : Thermal coefficient of resistance of leadwire ($3.9 \times 10^{-3}/^{\circ}\text{C}$ for copper)
- r : Total resistance of leadwire per 1 meter (Ω/m)
- L : Leadwire length (m)
- ΔT : Temperature change of leadwire ($^{\circ}\text{C}$)

Note)

- Compensation is possible on condition that the temperature change is uniform for whole length of the leadwire.
- In a quarter bridge 3-wire method, compensation is not necessary because the influence of change in leadwire resistance caused by temperature change is cancelled.
- Also our 1-Gauge 4-Wire Strain measurement method does not require above correction because it is not influenced at all by the leadwire resistance. Refer to following page for details.

Gauge Factor (Gauge sensitivity) correction for leadwire connection

The leadwire resistance between the strain gauge and strainmeter noticeably lowers the gauge factor. Calculation for the correction is required depending on the measurement method and on the leadwire type and length.

Quarter Bridge with 2-wire	Quarter Bridge with 3-wire
Correction coefficient of leadwire : A	Correction coefficient of leadwire : A
$A = \frac{R}{R + rL}$	$A = \frac{R}{R + \frac{rL}{2}}$
Corrected Gauge Factor : K_0	Corrected Gauge Factor : K_0
$K_0 = \frac{R}{R + rL} \quad K = A \cdot K$	$K_0 = \frac{R}{R + \frac{rL}{2}} \quad K = A \cdot K$
where	
R : Nominal gauge resistance in Ω	
r : Total resistance per meter of leadwire (Ω/m)	
K : Gauge Factor shown on package	
L : Length of leadwire in meter	

Total resistance per meter of typical TML pre-attached leadwire

In strain gauge, the leadwire resistance produces a deterioration of gauge sensitivity and thermal drift. The leadwire should be as thick and as short as possible.

Twisted leadwire



Construction core/diameter	7/0.12	10/0.12	7/0.16	7/0.18	12/0.18	20/0.18
Cross section area of lead wire (mm^2)	0.08	0.11	0.14	0.18	0.3	0.5
Total resistance of leadwire per meter (Ω)	0.44	0.32	0.24	0.20	0.12	0.07

Single-core leadwire

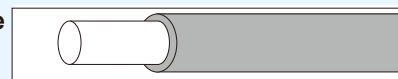

Construction	Polyimide wire (0.14mm-dia.)	Polyimide wire (0.18mm-dia.)
Cross section area of leadwire	0.015 mm^2	0.025 mm^2
Total resistance of leadwire per meter	2.5 Ω	1.5 Ω

Setting the Gauge Factor to TML Data Loggers*

$$C_s = \frac{2.00}{K_0} \quad C_s : \text{Coefficient set} \quad K_0 : \text{Gauge Factor corrected with leadwire attached}$$

For the detail of Data Loggers, refer to page 97.

1-Gauge 4-Wire Strain measurement method

For strain gauge measurement, the Wheatstone bridge circuit is employed according to the number of strain gauges to be used and measuring purpose. In a quarter bridge configuration, three wire method is widely used to remove the effect of temperature on gauge leadwire resistance. However, some measuring error occurs owing to gauge factor caused by leadwire resistance and variation in the contact resistance when leadwires are connected to the bridge.

The TML 1-gauge 4-wire strain measurement method does not use the Wheatstone bridge circuit, but instead a simple series circuit with gauge resistance (R) and reference resistance (R_s) to measure the strain. Find the strain with voltage (V) generated in gauge resistance and voltage (V_s) generated in reference resistance. As the path where the current runs and the path where the voltage is measured are different, it is possible to perform a measurement without being affected by leadwire resistance or contact resistance (r).

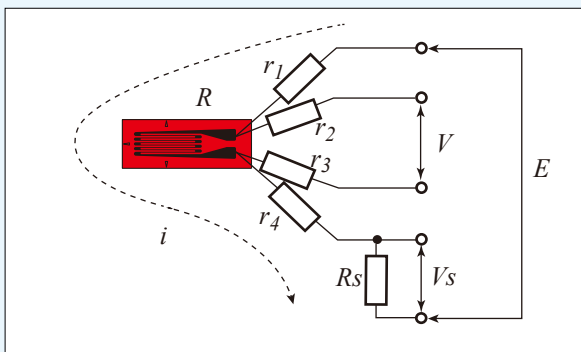

where

- R : Gauge resistance
- R_s : Reference resistance
- $r_1 \sim r_4$: Leadwire resistance and contact resistance
- i : Current flowing in gauge resistance and reference resistance
- E : Excitation voltage
- V : Voltage of gauge resistance
- V_s : Voltage of reference resistance

Not affected by contact resistance

Conventionally, leadwire extension and connection to a measuring instrument are done by soldering or the use of specially designed connectors. As the 1-gauge 4-wire method is not affected at all by contact resistance, a modular plug can be used. The modular plug makes leadwire extension and connection to the instrument inexpensive and efficient while preventing wiring mistakes are eliminated and also RoHS-compliant lead free soldering is unnecessary.

Compares Quarter Bridge 3-Wire vs. 1-Gauge 4-Wire

	Quarter Bridge 3-wire (Wheatstone Bridge)	1-Gauge 4-Wire
Plug connection	Not available	Available
Soldering works	Required	Not required
Wiring time	Required	Less
Wiring error	Occurs	None
RoHS directive	Lead inclusive	Lead free

Using commercial interconnection adapter, leadwire extension can be easily done.

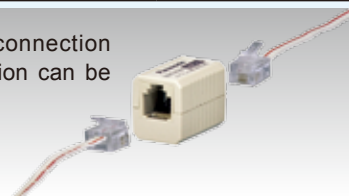

Leadwire resistance

In the conventional method, as thick and short leadwires as possible are recommended to keep the resistance of leadwires lower. However, as the 1-gauge 4-wire method is not influenced at all by the leadwire resistance, it is possible to connect thin and long leadwires to strain gauges.

Compares Quarter Bridge 3-Wire vs. 1-Gauge 4-Wire

	Quarter Bridge 3-wire (Wheatstone Bridge)	1-Gauge 4-Wire
Size of leadwire	Thick	Thin
Weight of leadwire	Not less	Less
Different leadwires	Not available	Available
Color of leadwire	Planned	Free
Load to specimen	Not less	Less
Carrying cost	Not less	Less

Strain gauges with leadwires and modular plug

Most of our strain gauges can be supplied with the pre-attached 4 leadwires and modular plug (RJ12) that make up our proprietary 1-Gauge 4-Wire system. Because a modular plug is attached to the end of the leadwires, soldering or screwing connections to a measuring instrument is unnecessary, but the instrument must be of TML make. The 4-wire leadwires are covered with polypropylene resin which does not generate noxious gas even if exposed to fire.

Single element strain gauge with 4-wire paralleled leadwire



Three-element rectangular rosette strain gauge

With 4-wire paralleled leadwire and modular plug

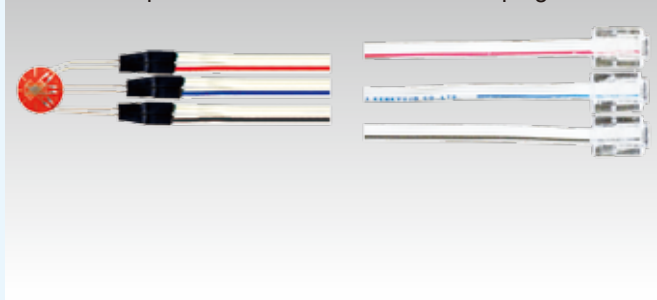

STRAIN GAUGE MEASUREMENT

Complete Compensation Method of Strain with Wheatstone Bridge - COMET

COMET: Abbreviation of Complete Compensation Method of Strain

When measuring strain using a strain gauge, quarter bridge method is commonly used. Quarter bridge 2-wire method is the easiest for strain measurement, while quarter bridge 3-wire method has an advantage of eliminating thermal output caused by the temperature change of the lead wire. It is known that there may be some small errors in measured values obtained by these methods, which are caused by initial unbalance and non-linearity of the bridge circuit. Most of our strainmeters already have a function of correcting non-linearity of quarter bridge circuit. However, if we look into the matter more closely, this function is not enough to completely correct the measured values, for example when the initial unbalance of the bridge is significant. Our unique technique "Complete Compensation Method of Strain" is a method which is capable of fully correcting the errors in measured values obtained by quarter bridge method without being influenced by initial unbalance and non-linearity of the bridge circuit. This method is available in our instruments listed below.

Data loggers

TDS-630, TDS-540, TDS-530*, TDS-602*, TDS-303*, TDS-150, TDS-102*, TC-31K*, TC-32K * : No longer in production

Measurement error is not caused by initial unbalance of bridge

If the resistance of strain gauge and bridge completion resistors is not exactly the same when the strain is zero, an output voltage is yielded. This should more or less occur in actual bridge circuits. The output voltage is treated as an initial unbalance and deducted from the output voltage when strain is applied. However, it causes some error in measured strain values. This error becomes zero by using the Complete Compensation Method of Strain. It is especially effective in cases as follows, in which a large initial unbalance is expected.

- The leadwire is extended during the measurement.
- The strain gauge is mounted on a curved surface.
- Strain gauges having uneven resistance are used.
- Temperature change is large during the measurement.

Non-linearity error of bridge circuit is completely corrected

The relation between the output voltage of bridge circuit and the strain is not exactly linear. Non-linearity error becomes larger with increase of strain. Conventional method for correcting the non-linearity is based on condition that the initial unbalance of bridge is zero. The Complete Compensation Method of Strain works to correct the non-linearity error even when the initial unbalance of bridge is large. It is also effective in the following cases in addition to the cases mentioned in former clause.

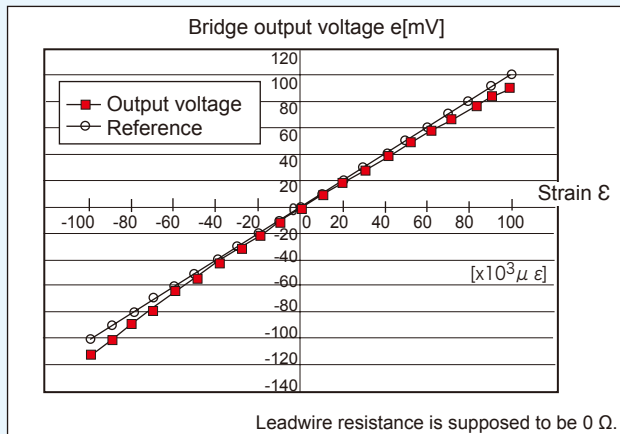

- Strain gauge is replaced with a new one when measuring large strain.
- Initial unbalance is readjusted during the measurement.

Descent of sensitivity caused by the leadwire resistance is corrected

The strain gauge sensitivity is influenced by the resistance of the leadwire. In quarter bridge 3-wire method, the leadwire resistance is measured and the sensitivity is corrected automatically by using a data logger having the Complete Compensation Method of Strain. When measuring multiple points of strain gauges, it is not necessary to use lead wires of the same length for the purpose of simplifying the correction calculation.

Complete Correction of thermal output of strain gauge

Thermal output of strain gauge is given as data under no strain, and it may somewhat differ under strained condition. The Complete Compensation Method of Strain compensates thermal output by taking the applied strain into consideration. This is especially effective when the thermal output is large. (This compensation is available in TDS-630.)

Correction of error caused by replacement of strain gauge

When measuring a large strain, it is a common practice to replace the strain gauge with a new one when the strain comes close to strain limit of the strain gauge. In this case, accurate strain after the replacement can be known by correcting the measured values referring to the strain value at the time of replacement. The Complete Compensation Method of Strain makes this correction automatically.

Setting of true strain measurement (COMET)

This is the setting for performing a measurement correcting the error of strain value using the function called "COMET". When the sensor mode is quarter bridge 3-wire method, the measurement value is displayed by implementing non-linear correction even if [Not use] is selected. By selecting Comet, it is possible to obtain more correct strain value.

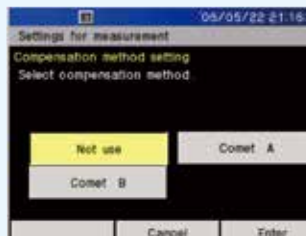

Half bridge common dummy can be used only for Comet A.

COMET A

This is the correction method to correct the non-linearity error by initial unbalance of the bridge, and this is effective when the initial unbalance value is large. The bridge output voltage e_0 is measured at initial in and memorized internally. The bridge output voltage e when the strain is generated is calculated when the measurement is performed, and the correction calculation below is implemented.

$$\epsilon_m = \frac{e - e_0}{(1-e) \times (1+e_0)}$$

COMET B (Quarter bridge 3-wire method only)

This is used when correcting the descent of sensitivity by leadwire at the same time as the correction method of Comet A.

The bridge output voltage e_0 at initial unbalance and both-ends voltage of lead wire resistance e_r are measured at initial in, and memorized internally. The bridge output voltage e when the strain is generated is measured at the measurement, and the calculation below is implemented.

$$\epsilon_m = \frac{e - e_0}{(1-e) \times (1+e_0-e_r)}$$

When Comet B calculation is implemented, the correction calculation that includes initial unbalance value that is recorded at initial in and both-ends voltage of leadwire resistance is implemented from the formula above, so only the measure measurement is available. Be sure to perform the measurement after implementing the initial in at the initial unbalanced status for starting measurement.

Application example of Complete Compensation Method of Strain

Measurements using our data loggers equipped with Complete Compensation Method of Strain have the advantages of the followings.

- Complete compensation of non-linearity
- No influence of strain gauge resistance
- No influence of dummy resistance
- No need of using leadwires of the same length saving costs and space for unnecessary leadwires
- No need of correcting sensitivity change caused by leadwire resistance

Accurate strain measurement is possible owing to the features above. Furthermore, measurements as in the following examples become possible by the use of Complete Compensation Method of Strain.

Application example 1:

Compensation of thermal output when using a temperature-integrated strain gauge

Thermal output of strain gauge is automatically compensated when measuring a temperature-integrated strain gauge with data logger TDS-630. A polynomial representing the thermal output is attached to each strain gauge, and coefficients of the polynomial are input to TDS-630 before starting the measurement. Thermal output of the strain gauge caused by the change of environmental temperature is calculated and corrected by the TDS-630 with better accuracy than conventional method.

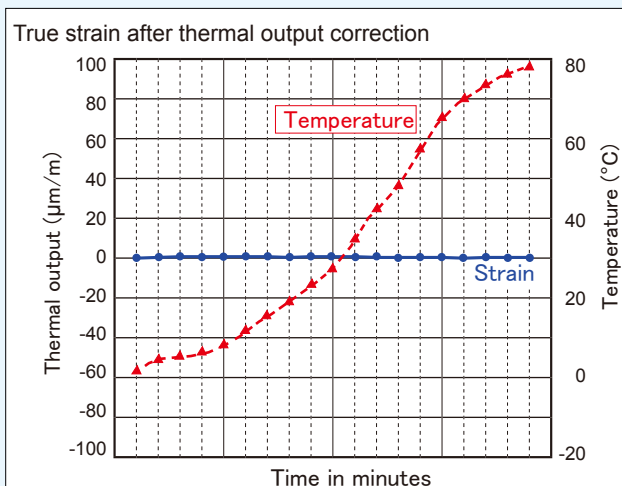
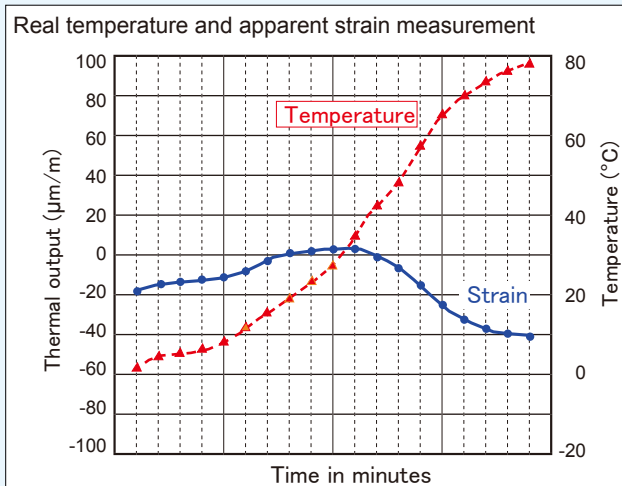

Application example 2:

Measurement of stress concentration gauge CCFXX, CCFYX

The CCFXX and CCFYX are newly developed strain gauges having 10 grids aligned continuously without interval between each adjoining grids. Different from the conventional stress concentration gauge having individual grids aligned with small intervals, it can measure strain distribution of the specimen more precisely. This strain gauge should be measured using our data logger with Complete Compensation Method of Strain. The number of leadwires is reduced to 11.

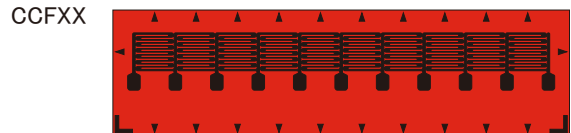

Measurement example
Strain caused by depression of bolt head (M10)

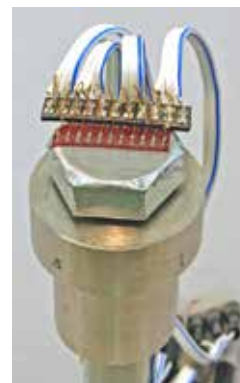
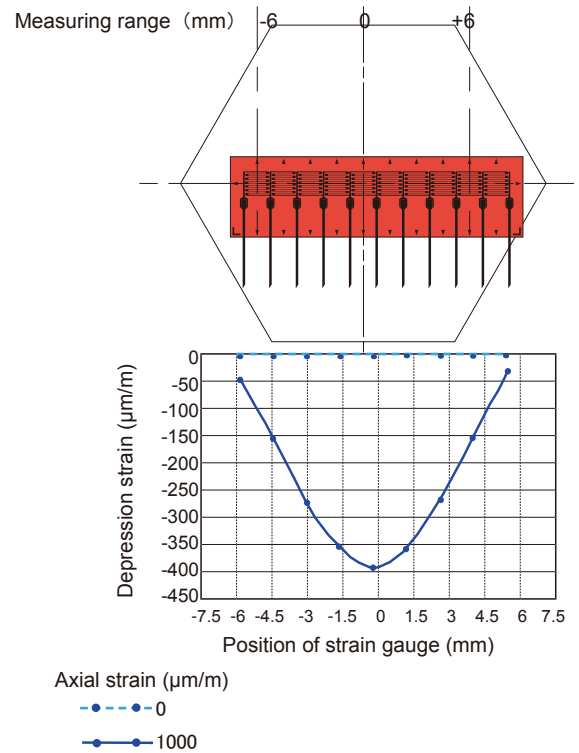

The number of leadwires is 30 which is required for measuring a conventional 10-element strain gauge with quarter bridge 3-wire method. The number is reduced to 11 in CCFXX/CCFYX strain gauge. This is achieved by using one leadwire for measurement of two or three grids. The adjacent grid is connected in series with one leadwire of 3-wire connection. The resistance of this adjacent grid can be ignored by using our data logger with Complete Compensation Method of Strain.

MEASURING METHOD OF STRAIN AND TEMPERATURE

■Measuring method of temperature

Temperature measurement is necessary for strain measurement involving temperature change. In addition to the thermocouples and platinum RTDs which are generally used for measuring temperature, our product line includes temperature gauges which may be used in a same way as strain gauges, and temperature integrated strain gauges which are capable of measuring strain and temperature simultaneously. We will provide you with the introduction of their features and applications.

Temperature measurement applications to our strain measuring instruments

Temperature measurement means	Application to static strain measuring instruments	Application to dynamic strain measuring instruments	Temperature measurement range (°C)	Features
Thermocouple (T, K, etc.)	Applicable	Applicable	-269 ~ +1760	Wide temperature range
Platinum RTD Pt100	Applicable	Not applicable	-40 ~ +400	High accuracy. Can be used only with data loggers
Temperature integrated strain gauges	Applicable	Not applicable	-20 ~ +200	Applicable to most of the foil strain gauges
Temperature gauges TF Series	Applicable	Applicable	-20 ~ +200	A dedicated adapter necessary
Temperature gauge KT-110A	Applicable	Applicable	-30 ~ +80	Robust structure, mainly for civil engineering

THERMOCOUPLE

Wide range of temperature can be measured by selecting the types of thermocouple wire and sheath material. In this catalog, the following sheath material for thermocouples are introduced (the temperatures indicated are upper temperature limits):

- Vinyl: 80 °C
 - Fluorinated resin: 200 °C
 - Glass fiber : 400 °C
- See page 80 for the details of thermocouples.

By using static strain measuring instruments such as data logger TDS series and TC-32K, temperature measurement using various thermocouples can be carried out. As for DC dynamic strain measuring instrument DC-96A/DC-97A, DC-204R, DC-004P, DH-14A, TMR-200, DRA-30A and DS-50A, temperature measurement can be carried out by thermocouples K and T through thermocouple adapter TA-01KT.

PLATINUM RTD

Temperature measurement can be carried out by bonding the platinum RTD to the surface of an object to be measured, just like when using strain gauges. The measurement accuracy is high, and the measurement can be done by connecting to lead

wires for strain gauges. Platinum RTD is connected to static strain measuring instruments such as data logger TDS series or TC-32K when measuring. Platinum RTD is not applicable to dynamic strain measuring instruments.

TEMPERATURE-INTEGRATED STRAIN GAUGES

Temperature measurement function can be mounted to almost any foil strain gauge. (See the chart in pages 41 and 42 for combination of strain gauges and dedicated lead wires.) The temperature measurement point is the tab of a strain gauge, so the temperature shown is as same as the temperature of the strain gauge. The temperature can be measured using our data logger.

If you wish to mount the temperature measuring function on the strain gauge of your choice, insert a "T" after the number indicating the length of the gauge, and then designate the length and type of the lead wire. For example, if you want to add temperature measuring function and a 3meters vinyl lead wire to FLA-2-11, the type name should be written as:

The applicable lead wires with temperature measuring function are as follows:

- Single core 3-wire twisted fluorinated resin (FEP) lead wire 6FB_TLT Applicable temperature: -269 °C ~ +200 °C
 - 3-wire paralleled vinyl lead wire -TLJBT/-TLJBT-F Applicable temperature: -20 °C ~ +80 °C
 - 4-wire paralleled vinyl lead wire TLQ Applicable temperature: -20 °C ~ +80 °C
- (See page 34 for details of lead wires.)

FLA-2 T -11 -3 TLJBT

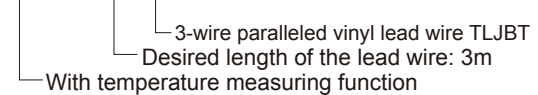

Temperature integrated strain gauges are not applicable to measurements by dynamic strain measuring instruments.

Wire connection methods

1. For TDS-630/-540/-530

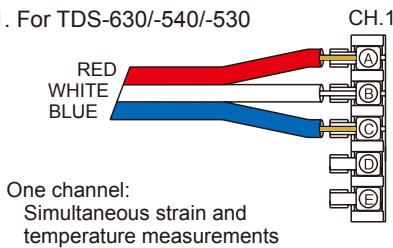

2. For other applicable measuring instruments: TDS-302/-303/-601/-601A/-602/-101R/-150/-102/-300

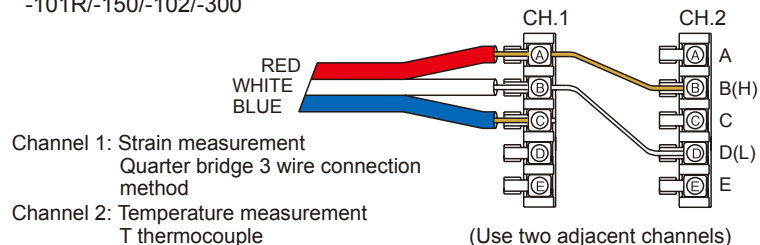

TEMPERATURE GAUGES TF SERIES

Temperature gauge TF series is used for measuring surface temperature by bonding it to the surface of structural object just like strain gauges. By using adapter TGA for temperature gauge and strain measuring instrument in combination, the

measurement will be performed and represented in the unit of $100 \times 10^{-6} / ^\circ\text{C}$. See page 80 for details of TF series and adapter TGA.

TEMPERATURE GAUGES KT-110A

KT-110A is a temperature sensor using full bridge method. It is used in civil engineering and construction sites for its robustness. KT-110A can carry out measurement as

temperature sensor using full bridge method (also used by transducers) by using strain measuring instruments. Consult us for details of KT-110A.

FOIL STRAIN GAUGES Series F



Gauges Of Brilliant Lifespan and Environmentally Thoughtful

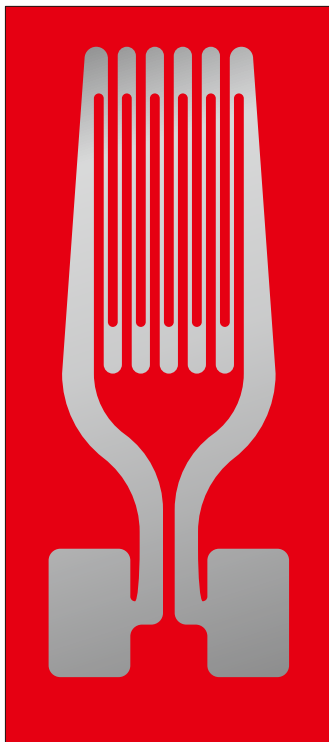

A strain gauge is constructed so that the gauge leads to conduct electrical signal are connected by soldering to the metal foil which is called gauge element. The solder is an alloy composed of lead and tin. Since lead is not only harmful to human bodies but may cause adverse effects on the natural environment, we have developed a strain gauge using lead-free solder. It is known that the use of lead-free solder may result in a shorter fatigue life of the strain gauge compared to a strain gauge using conventional solder including lead. To overcome the problem, we have developed a strain gauge having a unique gauge pattern and special plastics backing. With the use of lead-free solder for the connection of gauge leads, the strain gauge of this configuration shows a fatigue life equivalent to that of conventional strain gauges. Most of general purpose strain gauges in our strain gauge series F are available in this configuration, and they are supplied as RoHS compliant products with CE marking.

We have given a name GOBLET especially for the strain gauges, as the pattern looks like a goblet. GOBLET is also an abbreviation of "Gauges Of Brilliant Lifespan and Environmentally Thoughtful", which represents the excellent fatigue life and small environmental effect of the strain gauges and expresses the concept of development of the strain gauges.

Owing to the use of special plastics for the backing, operating temperature range of the gauges has been improved to -196 to +150°C. Integral leadwires for instrumentation are available using lead-free solder and in various types to meet usage conditions.

We will keep extending the GOBLET to other series of our strain gauges, not only to satisfy the needs for strain gauges but to meet environmental requirements including effective use of natural resources.

Trademark application pending in Japan



Package of GOBLET strain gauges (example)

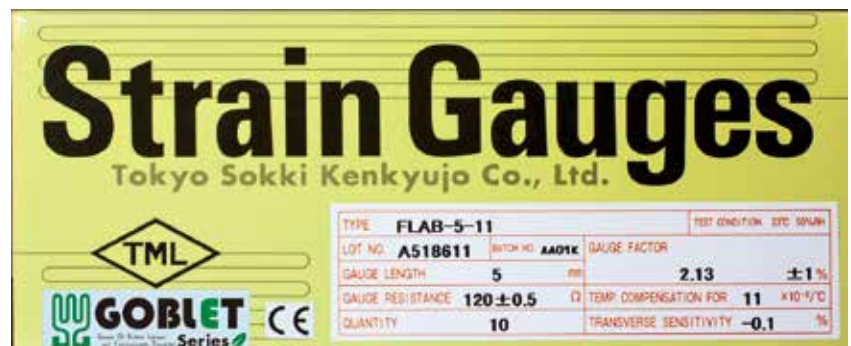





The GOBLET strain gauges bear the logo and the CE mark on their package.

Dedicated leadwires (lead-free solder used)

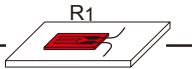
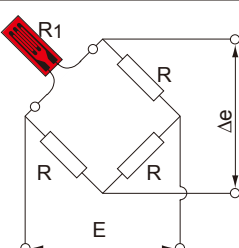
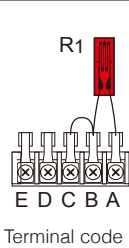
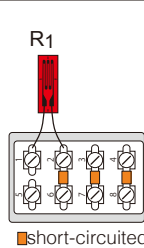
Leadwire type	Code to order	Core/Dimensions	Cross section (mm ²)	Combination temperature for use with GOBLET strain gauge
0.08mm ² paralleled vinyl leadwire	LJB-F	7/0.12	0.08	-20~+80°C
0.08mm ² 3-wire paralleled vinyl leadwire	LJBT-F	7/0.12	0.08	-20~+80°C
0.11mm ² paralleled vinyl leadwire	LJC-F	10/0.12	0.11	-20~+80°C
0.11mm ² 3-wire paralleled vinyl leadwire	LJCT-F	10/0.12	0.11	-20~+80°C
0.08mm ² polyporopyrene 4-wire paralleled leadwire with modular plug	LQM-F	7/0.12	0.08	-20~+100°C
0.08mm ² vinyl 4-wire paralleled leadwire	LBQM-F	7/0.12	0.08	-20~+80°C
3-wire paralleled special vinyl leadwire	LXT-F	7/0.12	0.08	-20~+150°C
Temperature-integrated 3-wire paralleled vinyl leadwire	TLJBT-F	7/0.12	0.08	-20~+80°C
0.14mm ² /polyurethane leadwire 0.18mm ² polyurethane leadwire	LP-F	1/0.14 1/0.18	-	-20~+120°C
0.14mm ² polyester leadwire 0.18mm ² polyester leadwire	LU-F	1/0.14 1/0.18	-	-196~+150°C
0.14mm ² polyimide leadwire 0.18mm ² polyimide leadwire	LE-F	1/0.14 1/0.18	-	-196~+150°C

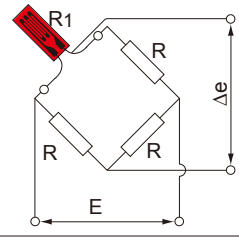
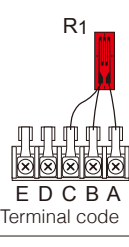
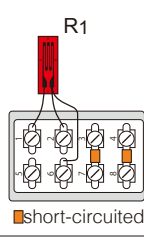
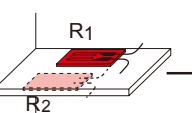
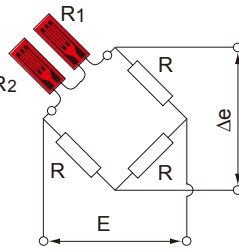
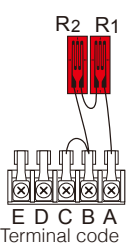
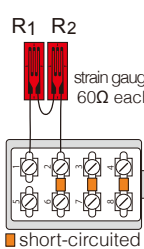
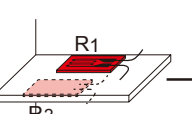
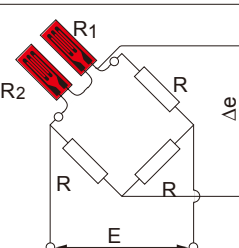
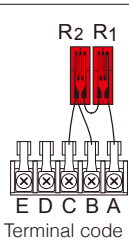
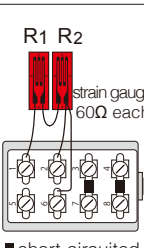
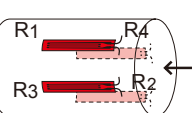
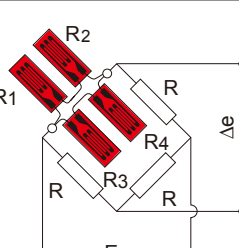
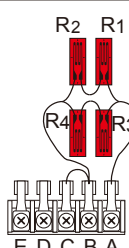
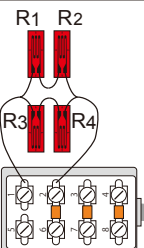
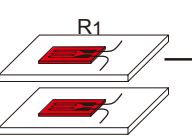
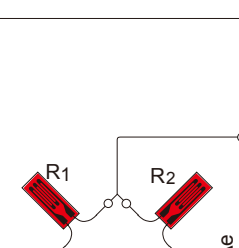
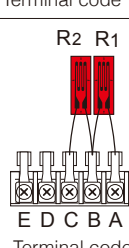
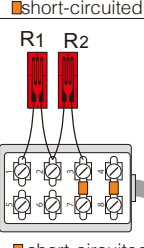

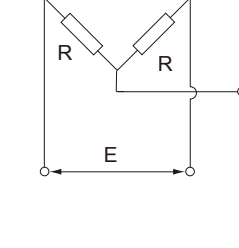
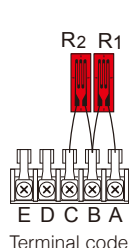
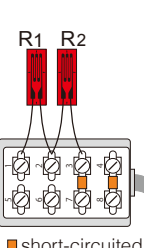

STRAIN GAUGE BRIDGE CIRCUIT

	Measuring mode	Bridge circuit	Wiring connection to		Bridge Output
			Switching Box	Bridge Box	
1	Quarter bridge (with 2-wire) 		 Terminal code	 ■ short-circuited	$\Delta e = \frac{E}{4} \times \frac{\Delta R_1}{R} = \frac{E}{4} K \cdot \epsilon_1 = \frac{E}{4} K \cdot \epsilon$ <p> Δe : Output voltage due to strain ϵ_1 E : Excitation voltage K : Gauge Factor of strain gauge R : Fixed resistor ΔR_1 : Resistance change due to strain ϵ_1 $R_1 = R_0 + \Delta R_1$: Gauge resistance due to ϵ_1 R_0 : Gauge resistance before strain applied $\epsilon_1 = \epsilon$ </p>
2	Quarter bridge with 3-wire 		 Terminal code	 ■ short-circuited	
3	Quarter bridge with two gauges connected in series in one arm, eliminating bending strain 		 Terminal code	 ■ short-circuited	$\Delta e = \frac{E}{4} \times \frac{(\Delta R_1 + \Delta R_2)}{R} = \frac{E}{4} \cdot K \cdot \frac{(\epsilon_1 + \epsilon_2)}{2}$ $= \frac{E}{4} \cdot K \cdot \epsilon$ <p> R_1 : Strain Gauge resistance = $R_0 + \Delta R_1$ R_2 : Strain Gauge resistance = $R_0 + \Delta R_2$ $R = 2R_0$ R_0 : Gauge resistance before strain applied $\Delta R_1, \Delta R_2$: Resistance change of strain gauge R_1, R_2 ϵ_1, ϵ_2 : Strain applied to strain gauge R_1, R_2 R : Fixed resistor </p>
4	Quarter bridge 3-wire with two gauges connected in series in one arm, eliminating bending strain 		 Terminal code	 ■ short-circuited	
5	Quarter bridge with four gauges connected in series and paralleled in one arm 		 Terminal code	 ■ short-circuited	$\Delta e = \frac{E}{4} \times \frac{(\Delta R_1 + \Delta R_2 + \Delta R_3 + \Delta R_4)}{4R}$ $= \frac{E}{4} \times \frac{(\epsilon_1 + \epsilon_2 + \epsilon_3 + \epsilon_4)}{4} = \frac{E}{4} K \cdot \epsilon$ <p> $\Delta R_1 \sim \Delta R_4$: Resistance change of strain gauge $R_1 \sim R_4$ $\epsilon_1 \sim \epsilon_4$: Strain applied to strain gauge $R_1 \sim R_4$ $\epsilon_1 = \epsilon_2 = \epsilon_3 = \epsilon_4 = \epsilon$ </p>
6	Half bridge with 1-active and 1-dummy gauge 		 Terminal code	 ■ short-circuited	$\Delta e = \frac{E}{4} \times \frac{\Delta R_1}{R} = \frac{E}{4} K \cdot \epsilon_1 = \frac{E}{4} K \cdot \epsilon$ <p> $\epsilon_1 = \epsilon$: Axial strain $R_1 = R_0 + \Delta R$: active $R_2 = R_0 = R$: dummy R : Fixed resistor R_0 : Gauge resistance before strain applied </p>
7	Half bridge with two active gauges 		 Terminal code	 ■ short-circuited	$\Delta e = \frac{E}{4} \times \frac{(\Delta R_1 - \Delta R_2)}{R} = \frac{E}{4} K \cdot (\epsilon_1 - \epsilon_2)$ $= \frac{E}{4} (1 + \nu) K \cdot \epsilon$ <p> ν : Poisson's ratio $\epsilon_1 = \epsilon$: Strain applied to strain gauge R_1 $\epsilon_2 = -\nu \epsilon$: Strain applied to strain gauge R_2 R : Fixed resistor </p>

STRAIN GAUGE BRIDGE CIRCUIT

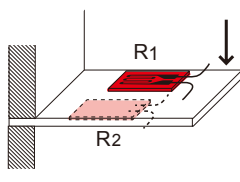
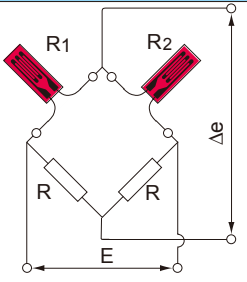
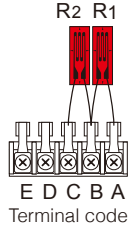
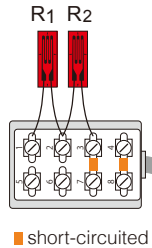
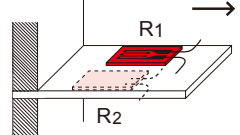
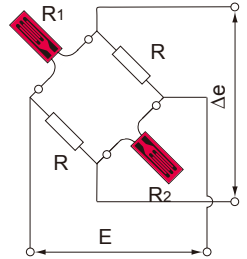
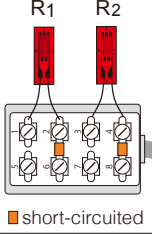
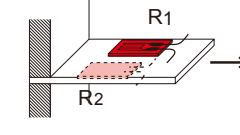
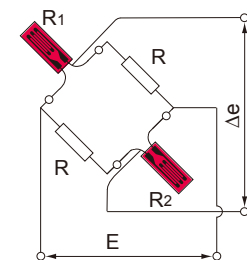
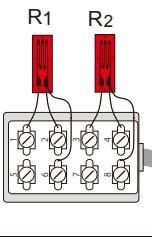
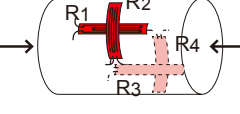
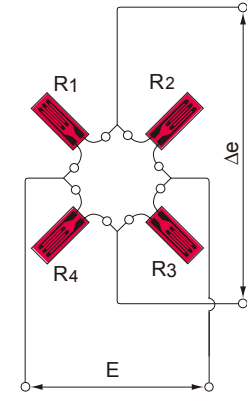
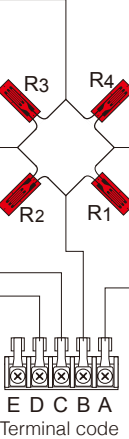
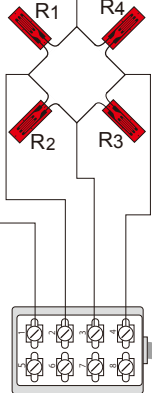
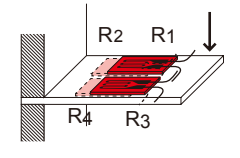
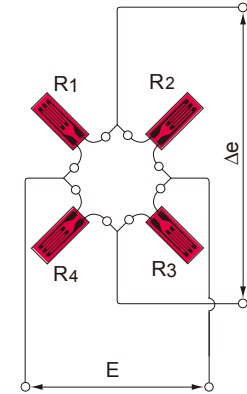
	Temperature-compensated to		Output multiple	Gauge Factor correction due to leadwire resistance	Description
	Strain Gauge	Leadwire			
	N/A	N/A	x1	$K_0 = \frac{R}{R+rL} K$	Ordinary uniaxial strain measurement when influence of temperature change can be disregarded. K_0 : Corrected gauge factor K : Original gauge factor R : Resistance of strain gauge r : Total resistance of leadwire per meter L : Length of leadwire in meter
	N/A	Available	x1	$K_0 = \frac{R}{R + \frac{rL}{2}} K$	Ordinary uniaxial strain measurement Thermal output of leadwire is cancelled. K_0 : Corrected gauge factor K : Original gauge factor R : Resistance of strain gauge r : Total resistance of leadwire per meter L : Length of leadwire in meter
	N/A	N/A	x1	$K_0 = \frac{R}{R+rL} K$	Uniaxial strain measurement (Mean of two gauges is output) bending strain is cancelled. K_0 : Corrected gauge factor K : Original gauge factor R : Resistance of strain gauge r : Total resistance of leadwire per meter L : Length of leadwire in meter
	N/A	Available	x1	$K_0 = \frac{R}{R + \frac{rL}{2}} K$	Thermal output of leadwire is cancelled in addition to the above. K_0 : Corrected gauge factor K : Original gauge factor R : Resistance of strain gauge r : Total resistance of leadwire per meter L : Length of leadwire in meter
	N/A	N/A	x1	$K_0 = \frac{R}{R+rL} K$	Uniaxial strain measurement (Mean of four gauges is output.) Bending strain is cancelled. If 3-wire connection is used, thermal output of leadwire is cancelled. K_0 : Corrected gauge factor K : Original gauge factor R : Resistance of strain gauge r : Total resistance of leadwire per meter L : Length of leadwire in meter
	Available	Available	x1	$K_0 = \frac{R}{R+rL} K$	Uniaxial strain measurement Dummy gauge should be of the same type and lot as the active gauge, bonded on the same kind of material, and placed in the same environment including the leadwire. K_0 : Corrected gauge factor K : Original gauge factor R : Resistance of strain gauge r : Total resistance of leadwire per meter L : Length of leadwire in meter
	Available	Available	x (1+ν)	$K_0 = \frac{R}{R+rL} K$	Axial strain measurement with sensitivity of (1+ν) times. Thermal output of strain gauge and leadwire is cancelled. K_0 : Corrected gauge factor K : Original gauge factor R : Resistance of strain gauge r : Total resistance of leadwire per meter L : Length of leadwire in meter ν : Poisson's ratio of specimen

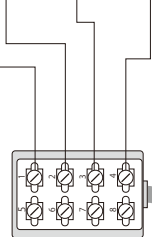
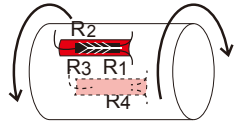
STRAIN GAUGE BRIDGE CIRCUIT

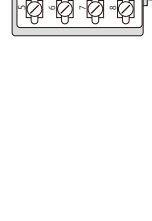
	Measuring mode	Bridge circuit	Wiring connection to		Bridge Output
			Switching Box	Bridge Box	
8	Half bridge with 2 active gauges : Bending strain 		 <p>Terminal code E D C B A</p>	 <p>■ short-circuited</p>	$\Delta e = \frac{E}{4} \times \frac{(\Delta R_1 - \Delta R_2)}{R} = \frac{E}{4} \cdot K \cdot (\epsilon_1 - \epsilon_2)$ $= \frac{E}{2} \cdot K \cdot \epsilon$ <p>E : Excitation voltage K : Gauge Factor of strain gauge ε : Strain due to bending ε₁ = -ε₂ = ε</p>
9	Opposite arm Half bridge with 2 active gauges 		N/A	 <p>■ short-circuited</p>	$\Delta e = \frac{E}{4} \times \frac{(\Delta R_1 + \Delta R_2)}{R} = \frac{E}{4} \cdot K \cdot (\epsilon_1 + \epsilon_2)$ $= \frac{E}{2} \cdot K \cdot \epsilon$ <p>E : Excitation voltage K : Gauge Factor of strain gauge ε : Uniaxial strain ε₁ = ε₂ = ε</p>
10	Opposite arm Half bridge with 3-wire 2 active gauges 		N/A	 <p>■ short-circuited</p>	$\Delta e = \frac{E}{4} \times \frac{(\Delta R_1 + \Delta R_2)}{R} = \frac{E}{4} \cdot K \cdot (\epsilon_1 + \epsilon_2)$ $= \frac{E}{2} \cdot K \cdot \epsilon$ <p>E : Excitation voltage K : Gauge Factor of strain gauge ε : Uniaxial strain ε₁ = ε₂ = ε</p>
11	Full bridge with 4 active gauges : Uniaxial strain 		 <p>Terminal code E D C B A</p>	 <p>■ short-circuited</p>	$\Delta e = \frac{E}{4} \times \frac{(\Delta R_1 - \Delta R_2 + \Delta R_3 - \Delta R_4)}{R}$ $= \frac{E}{4} K (\epsilon_1 - \epsilon_2 + \epsilon_3 - \epsilon_4) = \frac{E}{2} (1 + \nu) \cdot K \cdot \epsilon$ <p>E : Excitation voltage K : Gauge Factor of strain gauge ε : Axial strain ν : Poisson's ratio ε₁ = ε₃ = ε, ε₂ = ε₄ = -ν·ε</p>
12	Full bridge with 4 active gauges : Bending strain 		 <p>Terminal code E D C B A</p>	 <p>■ short-circuited</p>	$\Delta e = \frac{E}{4} \times \frac{(\Delta R_1 - \Delta R_2 + \Delta R_3 - \Delta R_4)}{R}$ $= \frac{E}{4} K (\epsilon_1 - \epsilon_2 + \epsilon_3 - \epsilon_4) = E \cdot K \cdot \epsilon$ <p>E : Excitation voltage K : Gauge Factor of strain gauge ε : Strain due to bending ε₁ = ε₃ = ε, ε₂ = ε₄ = -ε</p>
13	Full bridge with 4 active gauges : Torque 		 <p>Terminal code E D C B A</p>	 <p>■ short-circuited</p>	$\Delta e = \frac{E}{4} \times \frac{(\Delta R_1 - \Delta R_2 + \Delta R_3 - \Delta R_4)}{R}$ $= \frac{E}{4} K (\epsilon_1 - \epsilon_2 + \epsilon_3 - \epsilon_4) = E \cdot K \cdot \epsilon$ <p>E : Excitation voltage K : Gauge Factor of strain gauge ε : Strain due to torque ε₁ = ε₃ = ε, ε₂ = ε₄ = -ε</p>

STRAIN GAUGE BRIDGE CIRCUIT

	Temperature-compensated to		Output multiple	Gauge Factor correction due to leadwire resistance	Description
	Strain Gauge	Leadwire			
	Available	Available	x2	$K_0 = \frac{R}{R+r} K$	Bending strain measurement with twice sensitivity Axial strain is cancelled. Thermal output of strain gauge and leadwire is cancelled. K ₀ : Corrected gauge factor K : Original gauge factor R : Resistance of strain gauge r : Total resistance of leadwire per meter L : Length of leadwire in meter
	N/A	N/A	x2	$K_0 = \frac{R}{R+r} K$	Uniaxial strain measurement (sum of two gauges is output.) Bending strain is cancelled. K ₀ : Corrected gauge factor K : Original gauge factor R : Resistance of strain gauge r : Total resistance of leadwire per meter L : Length of leadwire in meter
	N/A	Available	x2	$K_0 = \frac{R}{R + \frac{rL}{2}} K$	Thermal output of leadwire is cancelled in addition to the above. K ₀ : Corrected gauge factor K : Original gauge factor R : Resistance of strain gauge r : Total resistance of leadwire per meter L : Length of leadwire in meter
	Available	Available	x2(1+ν)	$K_0 = \frac{R}{R+r} K$ rL should be of the leadwire for supplying excitation voltage, provided that the leadwire resistance inside the full bridge circuit is small enough to be neglected.	Uniaxial strain measurement with sensitivity of 2(1+ν) times. Bending strain is cancelled. ν : Poisson's ratio of specimen K : Original gauge factor K ₀ : Corrected gauge factor R : Resistance of strain gauge r : Total resistance of leadwire per meter L : Length of leadwire in meter
	Available	Available	x4		Bending strain measurement with sensitivity of 4 times Axial strain is cancelled.
	Available	Available	x4		Measurement of strain due to torque with sensitivity of 4 times Axial strain and bending strain are cancelled.

Connection diagram varies according to strainmeter type.

TML STRAIN GAUGE CODING SYSTEM

F LA - 3 T - 350 - 11 (-F) -

Gauge length in mm

Gauge resistance in Ω
(standard 120 Ω not presented)

(*3) See Compensation material right

Functions (*2)	Applicable gauge
A Left 45°	QFLT-A
B Right 45°	QFLT-B
for shearing strain measurement	
T Thermocouple	Temperature-integrated

(*2) Not indicated for general model

Option -F

Strain gauge with CE marking (compliant to RoHS2 Directive)
Identification code "-F" is appended to the type number of the strain gauge.
For a strain gauge with "Option -F", lead-free solder is used in place of leaded solder. Fatigue life of the strain gauge may become shorter by using lead-free solder.

Gauge series	Applications
F GOBLET CE	General purpose F series of GOBLET are CE marked.
WF	Waterproof construction
PF CE	Concrete use, Polyester foil gauge
P CE	Concrete use, Polyester wire gauge
MF	Magnetic field use
PM	Concrete use, Embedment type strain gauge
PMF	Concrete use, Embedment type strain gauge
FLM/WFLM	Concrete use, Metal backing strain gauge
YEF/YF/YHF (-F)	Post-yield strain (Large strain) measurement
PMFLS	Asphalt use, Embedment type strain gauge
GF/LF	Low elastic material use, Plastics, Wood, Gypsum
PFLW/PLW	Low elastic material use, Wood, Gypsum
UBF/BF CE	Composite material use
DSF CE	High endurance use, Fatigue test
CF CE	Cryogenic temperature use
CEF CE	Wide range temperature use
QF/ZF/EF CE	High temperature use
SFA CE	Stress measurement
AW CE	Weldable strain gauge
BTM CE	Bolt axial strain measurement
DD	One-side gauge
FAC CE	Crack detection gauge
TF	Strain gauge type temperature measurement
KM CE	Concrete/Asphalt embedment use, strain transducer
FGMH	Frictional Strain Checker
FGAH	Frictional Axial strain transducer
FGDH	Frictional Torque Sensor System

The following strain gauges are CE marked.
For strain gauge without integral lead wire
- Strain gauge with "-F" appended to the type number
- Strain gauge indicated with "CE" mark in this catalog

Pattern configuration (*1)	
L/LA/LK/LX/LG/BX/BY LAB/LKB/LGB GOBLET CE	Single
C/CALC/CS/CB CAB GOBLET CE	2-element Rosette (0°/90°)
R/LR/RA/RAS/RS RAB GOBLET CE	3-element Rosette (0°/45°/90°)
XV/YV/BXV/BYV	5-element Single
CV	5-element Rosette (0°/90°)
CT	Torque
LT	45° Single

(*1) Not always coded

Pattern image

Single

2-element Rosette (0°/90°)
stacked plane

3-element Rosette (0°/45°/90°)
stacked plane

5-element Single 10-element Single

5-element Rosette (0°/90°)

Torque

45° Single

TML STRAIN GAUGE CODING SYSTEM

3 LJB(- F)

Length of leadwire pre-attached	
-002	2cm long
-005	5cm long
-1	1m long
-3	3m long
-5	5m long

Option -F
Leadwire with CE marking (compliant to RoHS2 Directive) Identification code “-F” is appended to the type number of the leadwire.

Compensation material ppm/°C (*3)	
Indicated only for self-temperature-compensated strain gauges For other materials, contact TML or your local representative.	
<u>3 Composite material</u>	
Ceramic (Si ₃ N ₄)	2.6~3.3
CFRP	3 ~ 5
<u>5 Composite material</u>	
Ceramic (SiC)	4.6
CFRP	3 ~ 5
<u>8 Composite material</u>	
Glass	7.9
Titanium	8.9
Titanium alloy (Ti-6Al-4V)	8.8
<u>11 Mild steel</u>	
Mild steel (0.1~0.2C)	11.8
Hard steel (0.4~0.5C)	11.2
Cast iron	10.5
Hastelloy-276	11.2
Inconel 600	13.3
Inconel 750	12.1
Monel	13.5
SUS 630 (17-4PH)	10.8
SUS 631 (17-7PH)	10.6
Concrete	7 ~ 13
<u>17 Stainless steel/Copper alloy</u>	
SUS 304	16.2
SUS 310	15.8
SUS 316	16.0
SUS 321	16.7
Copper	16.7
Beryllium copper	16.6
Brass	16.7
Bronze	17.0
Constantan	14.9
<u>23 Aluminium</u>	
Aluminium	23.4
Aluminium 2024-T4	23.0
Lead and its alloy	29.0
Gypsum	25.0
Polyimide	20 ~ 30
<u>28 Magnesium</u>	
Magnesium alloy	27.0
<u>50 Plastics</u>	
Epoxy (Cast)	45 ~ 65
<u>70 Plastics</u>	
Acrylics	70
ABS	74
Polycetal (POM)	80
Polycarbonate (PC)	66 ~ 70
Polystyrene (PS)	60 ~ 80

The following strain gauges are CE marked.
For strain gauge with integral lead wire - CE marked strain gauge as the above having integral leadwire with “-F” appended to the type number of the integral leadwire

Suffix codes of pre-attached leadwires	Option -F for CE marking
-LJB/-LJB-F : 0.08mm ² paralleled vinyl leadwire	-20°C~+80°C
Applicable to F/PF/P/FLM/YEF/YF/YHF/LF/PFLW/PLW/GF/BF/UBF/DSF/CF/CEF/QF/ZF/EF/BTM series	
-LJBT/-LJBT-F: 0.08mm ² 3-wire parallel leadwire	-20°C~+80°C
Applicable to same as above -LJB/-LJB-F	
-LJA : 0.08mm ² twisted vinyl leadwire	-20°C~+80°C
Applicable to F/FLM/MF/YEF/YF/YHF/LF/PFLW/PLW/GF/BF/UBF/DSF/CF/CEF/QF/ZF/EF series	
-LJAT : 0.08mm ² 3-wire twisted vinyl leadwire	-20°C~+80°C
Applicable to F/FLM/YEF/YF/YHF/LF/PFLW/PLW/GF/BF/UBF/DSF/CF/CEF/QF/ZF/EF/BTM series	
-LJC/-LJC-F : 0.11mm ² paralleled vinyl leadwire	-20°C~+80°C
Applicable to F/PF/P/FLM/YEF/YF/YHF/LF/PFLW/PLW/GF/BF/UBF/DSF/CF/CEF/QF/ZF/EF/BTM series	
-LJCT/-LJCT-F : 0.11mm ² 3-wire paralleled vinyl leadwire	-20°C~+80°C
Applicable to same as above -LJC/-LJC-F	
-LJD : 0.3mm ² paralleled vinyl leadwire	-20°C~+80°C
Applicable to F/FLM/YEF/YF/YHF/LF/PFLW/PLW/GF/BF/UBF/DSF/CF/CEF/QF/ZF/EF	
-LJDT : 0.3mm ² paralleled vinyl leadwire	-20°C~+80°C
Applicable to same as above -LJD	
-LJG : 0.5mm ² paralleled vinyl leadwire	-20°C~+80°C
Applicable to F/PF/P/FLM/YEF/YF/YHF/LF/PFLW/PLW/GF/BF/UBF/DSF/CF/CEF/QF/ZF/EF	
-LJGT : 0.5mm ² 3-wire paralleled vinyl leadwire	-20°C~+80°C
Applicable to same as above -LJG	
-LH : 0.02mm ² twisted vinyl leadwire	-20°C~+80°C
Applicable to F/FLM/YEF/YF/YHF/LF/PFLW/PLW/GF/BF/UBF/DSF/CF/CEF/QF/ZF/EF	
-LHT : 0.02mm ² 3-wire twisted vinyl leadwire	-20°C~+80°C
Applicable to same as above -LH	
-LJAY: 0.08mm ² 3-wire twisted vinyl leadwire	-20°C~+80°C
Applicable to MF (Single) series	
-LS : 3.2mm-dia. shielded vinyl leadwire	-20°C~+80°C
Applicable to MF series	
-LTSA : 3mm-dia. shielded 3-wire vinyl leadwire	-20°C~+80°C
Applicable to F/FLM/MF/LF/PFLW/PLW/GF/BF/UBF/DSF/CF/CEF/QF/ZF/EF series	
-LTSB : 5mm-dia. shielded 3-wire vinyl leadwire	-20°C~+80°C
Applicable to F/FLM/LF/PFLW/PLW/GF/BF/UBF/DSF/CF/CEF/QF/ZF/EF series	
-LQM/-LQM-F : 0.08mm ² polypropylene 4-wire paralleled leadwire with modular plug	-20°C~+100°C
Applicable to F/PF/P/FLM/YEF/YF/YHF/LF/PFLW/PLW/GF/BF/UBF/DSF/CF/CEF/QF/ZF/EF series	
-LBQM/-LBQM-F : 0.08mm ² vinyl 4-wire paralleled leadwire with modular plug	-20°C~+80°C
Applicable to same as above -LQM	
-LXT/-LXT-F : 3-wire parallel special vinyl leadwire	-20°C~+150°C
Applicable to F/PF/P/FLM/YEF/YF/YHF/LF/PFLW/PLW/GF/BF/UBF/DSF/CF/CEF/QF/ZF/EF series	
-LJRA : 2-wire twisted cross-linked vinyl leadwire	-20°C~+100°C
Applicable to F/FLM/YEF/YF/YHF/LF/PFLW/PLW/GF/BF/UBF/DSF/CF/CEF/QF/ZF/EF/BTM series	
-LJRTA : 3-wire twisted cross-linked vinyl leadwire	-20°C~+100°C
Applicable to same as above -LJRA	
-LJQTA : 3-wire twisted cross-linked polyethylene leadwire	-65°C~+125°C
Applicable to F/FLM/YEF/YF/YHF/LF/PFLW/PLW/GF/BF/UBF/DSF/CF/CEF/QF/ZF/EF/BTM series	
-TLJBT/-TLJBT-F : Temperature-integrated 3-wire paralleled vinyl leadwire	-20°C~+80°C
Applicable to F/PF/P/FLM/YEF/YF/YHF/LF/PFLW/PLW/GF/BF/UBF/DSF/CF/CEF/QF/ZF/EF series	
-TLQ : Temperature-integrated 4-wire paralleled vinyl leadwire	-20°C~+80°C
Applicable to F/FLM/YEF/YF/YHF/LF/PFLW/PLW/GF/BF/UBF/DSF/CF/CEF/QF/ZF/EF	
-6FB_TLT : Temperature-integrated 3-wire twisted fluorinated resin (FEP) leadwire	-269°C~+200°C
Applicable to same as above -TLQ	
-LP/-LP-F : 0.14mm ² /0.18mm ² polyurethane leadwire	-10°C~+120°C
Applicable to F/PF/P/FLM/MF/YEF/YF/YHF/LF/PFLW/PLW/GF/BF/UBF/DSF/CF/CEF/QF/ZF/EF/BTM/FAC series	
-LU/-LU-F : 0.14mm ² /0.18mm ² polyester leadwire	-196°C~+200°C
Applicable to F/PF/P/FLM/MF/YEF/YF/YHF/LF/PFLW/PLW/GF/BF/UBF/DSF/CF/CEF/QF/ZF/EF series	
-LE/-LE-F : 0.14mm ² /0.18mm ² polyimide leadwire	-269°C~+300°C
Applicable to same as -LP/-LP-F	
-6FA_LT/ -6FA_LT-F : 3-wire twisted fluorinated resin (FEP) leadwire	-269°C~+200°C
Applicable to F/FLM/MF/YEF/YF/YHF/LF/PFLW/PLW/GF/BF/UBF/DSF/CF/CEF/QF/ZF/EF/BTM series	
-6FAS_LT/ -6FAS_LT-F : 3-wire twisted fluorinated resin (FEP) leadwire	-269°C~+200°C
Applicable to same as above -6FA_LT	
-6FB_LT/ -6FB_LT-F : 3-wire twisted fluorinated resin (FEP) leadwire	-269°C~+200°C
Applicable to same as above -6FA_LT	
-6FC_LT/ -6FC_LT-F : 3-wire twisted fluorinated resin (FEP) leadwire	-269°C~+200°C
Applicable to F/FLM/MF/YEF/YF/YHF/LF/PFLW/PLW/GF/BF/UBF/DSF/CF/CEF/QF/ZF/EF series	
-6FD_LTS/-F : 1.5mm-dia. 3-wire twisted fluorinated resin (FEP) leadwire with shield	-269°C~+200°C
Applicable to MF series	
-4FA_LT/-4FA_LT-F : 3-wire twisted fluorinated resin (PTFE) leadwire	-269°C~+260°C
Applicable to same as above -6FB_LT	
-4FB_LT/ -4FB_LT-F : 3-wire twisted fluorinated resin (PTFE) leadwire	-269°C~+200°C
Applicable to same as above -6FB_LT	

For further information on combination use with strain gauges, refer to pages 33~42.

PACKAGE DESIGNATION

TML strain gauges are delivered together with TML Strain Gauge Test Data (example shown below). The evaluation methods conform to the National Aerospace Standard NAS942 (modified). For installation, handling and bonding procedures, please see the data sheet.

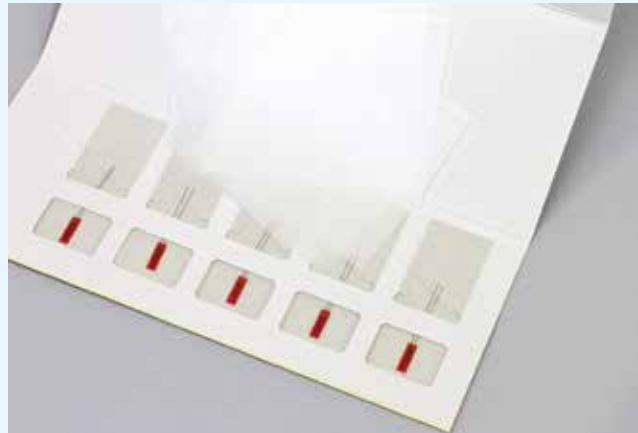
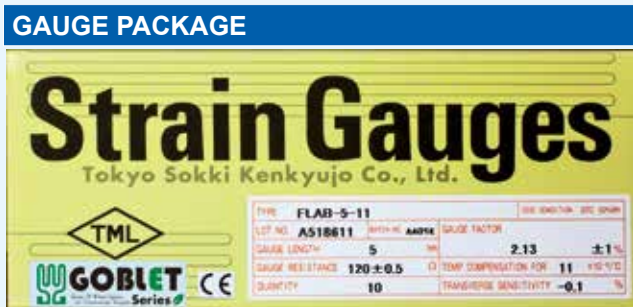

CE compliance

Affixing the CE marking and our logo mark of strain gauge GOBLET series to a container package

TEST DATA

TYPE	FLAB-5-11		TEST CONDITION	23°C 50%RH
LOT NO.	A518611	BATCH NO.	AA01K	GAUGE FACTOR
GAUGE LENGTH	5	mm	2.13	±1%
GAUGE RESISTANCE	120±0.5	Ω	TEMP. COMPENSATION FOR	11 ×10 ⁻⁶ /°C
QUANTITY	10		TRANSVERSE SENSITIVITY	-0.1%

Batch No.

Production code for procedure and history.

Environment

Temperature in degrees centigrade and relative humidity in % at which the test data are obtained.

Gauge type

Lot No.

Quantity

Number of gauges contained in a package.

Gauge resistance

Electrical resistance of the strain gauge under free conditions at room temperature, unbonded as supplied. Various range (60, 120, 350 or 1000Ω) are available.

Gauge length

This represents the actual grid length in the axial direction. Within this length, the measured strain is averaged.

Ratio of transverse sensitivity

The sensitivity in the direction perpendicular to the axial direction in percent.

Applicable temperature compensation

Various temperature compensation values are available (3, 5, 8, 11, 17, 23, 28, 50, 70ppm/°C) (Blank indicates temperature compensation not available.)

Gauge factor with tolerance

This factor is a ratio of the resistance variation to the strain generated due to the uniaxial stress in the direction of the gauge axis.

COLOR CODING FOR TEST SPECIMEN

Colors of package label differ depending on the test specimen material for temperature compensation.



Test specimen	Linear thermal expansion coefficient	Coloring	Gauge type exemplified
Mild steel	11ppm/°C	Red	FLA-5-11
Stainless steel	17ppm/°C	Brown	FLA-5-17
Copper alloy			
Aluminium	23ppm/°C	Green	FLA-5-23
Others	-	Grey	YFLA-5

PACKAGE DESIGNATION

LEADWIRE-INTEGRATED STRAIN GAUGE PACKAGE

LJCT : 3-wire system				LJB : 2-wire system			
TYPE	FLAB-5-11-3LJCT-F			TYPE	FLAB-5-11-5LJB-F		
LOT NO.	A518611	GAUGE LENGTH	5 mm	LOT NO.	A518611	GAUGE LENGTH	5 mm
GAUGE FACTOR	2.13 ±1 %			GAUGE FACTOR	2.13 ±1 %		
GAUGE RESISTANCE	120±0.5 Ω	QUANTITY	10	GAUGE RESISTANCE	117.7±0.3 Ω	QUANTITY	10
TEMP. COMPENSATION FOR	11 × 10 ⁻⁶ /°C	TEST CONDITION	23°C 50%RH	TEMP. COMPENSATION FOR	11 × 10 ⁻⁶ /°C	TEST CONDITION	23°C 50%RH
TRANSVERSE SENSITIVITY	-0.1 %	BATCH NO	AA01K	TRANSVERSE SENSITIVITY	-0.1 %	BATCH NO	AA01K
LEAD WIRES	10/0.12 3W 3m			LEAD WIRES	7/0.12 2W 5m r=0.44Ω/m		



LEADWIRES

Core number/diameter Wiring system Length of leadwire
 FLAB-5-11-3LJCT-F (Left)
 10/0.12 3W 3m : 10-core 0.12mm diameter, 3-wire, 3-meter long.
 FLAB-5-11-5LJB-F (Right)
 7/0.12 2W 5m r=0.44Ω/m : 7-core 0.12mm diameter, 2-wire, 5-meter long, leadwire resistance per meter 0.44Ω above

GAUGE RESISTANCE

For two-wire leadwire pre-attached strain gauge, the gauge resistance value does not include the lead wire resistance. For correction of gauge factor due to the prolonged leadwire resistance, refer to the resistance per meter (r value) given in LEAD WIRES.

TML STRAIN GAUGE TEST DATA

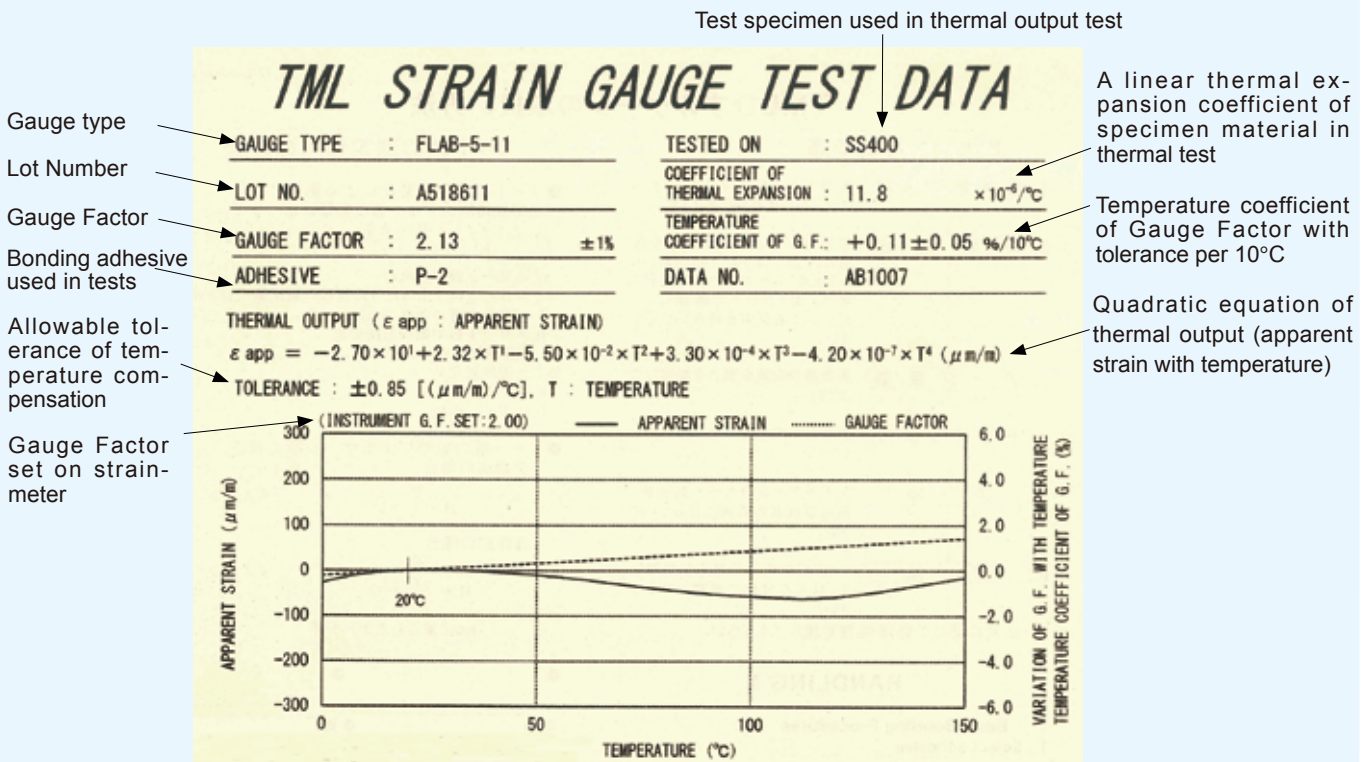

Example of curved data on thermal output

GAUGE FACTOR OF LEADWIRE PRE-ATTACHED STRAIN GAUGES

Gauge factor of leadwire pre-attached strain gauges given in the supplied TML STRAIN GAUGE TEST DATA is of the strain gauge itself, which is not corrected with attached leadwire. Refer to the test data sheet in which Gauge Factor Correction due to Leadwire attachment is given.

TML STRAIN GAUGE SELECTION

Gauge series selection chart

Material - Purpose	Gauges series & Operating temperature (°C)	Bonding adhesive	Coating materials	Lead wire insulator recommended
Metal				
General use Mid-high temperature	-196 F/ GOBLET +150	CN/P-2/EB-2	W-1/N-1/SB tape	Vinyl, FEP(6F)
	-20 PF +80	CN/P-2/EB-2	W-1/N-1/SB tape	Vinyl, Enamel
Underwater	0 WF +80	CN/P-2	W-1/N-1/SB tape	-LDBB, -LDBTB
General use High temperature High temperature Miniature, High Miniature, High Wide range temp. Cryogenic temp.	-20 QF +200	CN/P-2/EB-2	KE-348	FEP(6F), PTFE(4F)
	-20 ZF +300	C-1/NP-50B	TSE-3976-B	PTFE(4F)
	-196 EF(Single) +300	C N / E B - 2 / C - 1	KE-348 / TSE-	FEP(6F), PTFE(4F)
	-196 EF(2-/3-axis) +200	NP-50B	3976-B	FEP(6F), PTFE(4F)
	-269 CEF +200	EA-2A/CN/C-1	K-1/KE-348	FEP(6F), PTFE(4F)
-269 CF			FEP(6F), PTFE(4F)	
Spot welding	-196 AWM (Quarter with 3-wire) +300	Spot welding (Welder W-50RB)	Consult TML	MI cable
	-196 AWMD (Full bridge) for dynamic +800			
	-196 AWH (Full bridge) for static +600 for dynamic +650			
	-196 AWHU (Full bridge) +800			
	-196 AW-6 (Quarter with 3-wire) +300			
	-20 AWC +100 (Quarter with 3-wire/1 Gauge 4-wire)			
-196 AWCH (1 Gauge 4-wire) +200				
Long-term	-20 ZF +80	C-1/NP-50B/EB-2	W-1	Vinyl/Cross-linked vinyl / PTFE(4F)
	-196 AW-6 +80	Spot welding	SB tape	
Stress concentration	-196 F +150	CN/P-2/EB-2	N-1/SB tape	Vinyl
	-20 QF +200	EB-2/C-1/NP-50B	KE-348	FEP(6F)
Residual stress	-196 F +150	CN/P-2/EB-2	N-1/SB tape	Vinyl
Torque	-196 FCT +150	CN/P-2/EB-2	N-1/SB tape	Vinyl
	-20 QFCT +200	EB-2/C-1/NP-50B	KE-348	FEP(6F)
Shear strain	-20 FLT +80	CN/P-2/EB-2	N-1/SB tape	Vinyl
	-20 QFLT +200	EB-2/C-1/NP-50B	KE-348	FEP(6F)
One-side gauge	-10 DD +70	CN/P-2	—	Vinyl
Bolt axial strain	-10 BTM +80	A-2/CN	—	Vinyl
Large strain	-20 YEF/YF +80	CN/CN-Y	SB tape/N-1	Vinyl
	-30 YHF +80			
Metal or Concrete				
Magnetic field use	-20 MF +80 (Single element)	CN/CN-E/RP-2	N-1/SB tape	Twisted vinyl with shield
	-20 MF(2-/3-element) +200	CN/NP-50B EB-2/C-1	KE-348	Twisted FEP with shield
Concrete or Mortar				
Surface strain	-20 P/PF +80	CN-E/RP-2/PS	N-1/SB tape	Vinyl
	-20 FLM/WFLM	PS		Vinyl
Internal strain	-20 PM/PMF	Embedment	—	Vinyl
Asphalt				
Internal strain	-20 PMFLS +60	Embedment	—	Chloroprene
Plastics				
General purpose	-20 GF +80	CN	N-1/SB tape	Vinyl
Composite				
General purpose	-20 BF +200	CN/NP-50B/EB-2	N-1/SB tape KE-348	Vinyl, FEP(6F)
	-30 UBF for static +120 for dynamic +150	CN/EB-2		
Fatigue test	-60 DSF +200	CN/C-1/EB-2	—	Vinyl, FEP(6F)
Printed circuit board				
General purpose	-196 EF (Single element) +300	CN/NP-50B/EB-2	KE-348/TSE- 3976-B	Vinyl, FEP(6F) PTFE(4F)
	-196 EF (2-/3-element) +200			
Wood long-term/Gypsum				
General purpose	-20 PFLW/PLW/LF	PS/CN-E	W-1/N-1/SB tape	Vinyl
General use				
Temperature	-20 TF +200	CN/EB-2/NP-50B	W-1/SB tape/KE-348	Vinyl, FEP(6F)

Operating temperature range (°C)

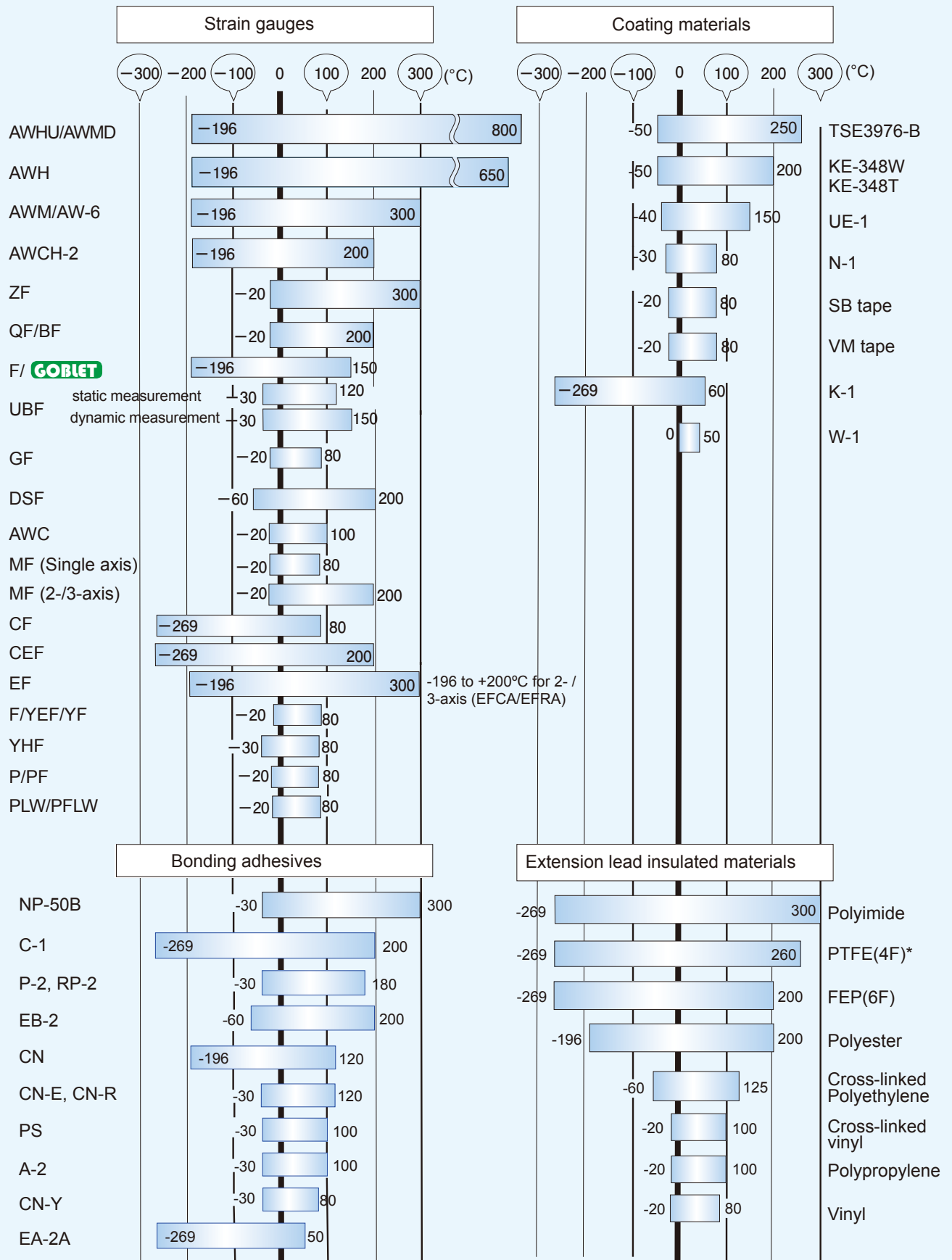

N.B.: PTFE(4F)
Short term use of 300°C available

TML STRAIN GAUGE SELECTION

GENERAL USE

F series Foil strain gauges (Option -F) P.43

These gauges employ Cu-Ni alloy foils for the grid and special plastics for the backing. The plastic backing exhibits excellent electrical insulation performance, and is color coded to identify the objective material for self-temperature-compensation. Various types of strain gauges are available in addition to general use gauges. Strain gauges using lead-free solder are available in this series with option code -F. Please note that fatigue life of the gauge with the option may become shorter by lead-free solder. The value in the following table is not presented for the option.

Operating temperature		Bonding adhesive	Materials		Strain limit (μE)	Fatigue life Strain level No. of cycles
Normal	Compensation		Backing	Grid		
-196~+150°C	+10~+100°C	CN/P-2 EB-2	Special plastics	Cu-Ni	5% (50,000)	±1,500μE 1x10 ⁶

- General use P.43
- Residual stress measurement (Option -F) P.46
- Shearing strain measurement (Option -F) P.45
- Torque measurement (Option -F) P.45
- Glass/Ceramic materials (Option -F) P.46
- Stress concentration measurement (Option -F) P.48

F series Foil strain gauges with CE marking P.48

Strain gauges compliant to RoHS2 Directive 2011/65/EU are added to the lineup in F series. They are supplied with CE marking as standard specification. Our logo GOBLET, which is an abbreviation of "Gauges Of Brilliant Lifespan and Environmentally Thoughtful", is marked on the package of these gauges.

Operating temperature		Bonding adhesive	Materials		Strain limit (μE)	Fatigue life Strain level No. of cycles
Normal	Compensation		Backing	Grid		
-196~+150°C	+10~+100°C	CN/P-2 EB-2	Special plastics	Cu-Ni	5% (50,000)	±1,500μE 1x10 ⁶

WATERPROOF CONSTRUCTION

WF series strain gauges P.52

These gauges eliminate the need for a moisture-proofing coating, which is sometimes troublesome in a field test. These have an integral vinyl leadwire, and whole area of the strain gauge and the leadwire junction are coated with epoxy resin. The coating is transparent and flexible, so the positioning and bonding works are very easy. By merely bonding the gauge with CN or P-2 adhesive, outdoor or underwater measurement for a short-term becomes possible. These gauges are also effective in eliminating the primary coating in case of applying a multi-layer coating.

Operating temperature		Bonding adhesive	Materials		Strain limit (μE)	Fatigue life Strain level No. of cycles
Normal	Compensation		Backing	Grid		
0~+80°C	+10~+80°C	CN/P-2	Epoxy	Cu-Ni	3% (30,000)	±1,500μE 3x10 ⁴

HIGH TEMPERATURE USE

QF series strain gauges P.53

These are foil strain gauges having a polyimide resin backing, which exhibits excellent performance in high temperature up to 200°C. Stress concentration measurement gauges and shear stress measurement gauges are also available in this series.

Operating temperature		Bonding adhesive	Materials		Strain limit (μE)	Fatigue life Strain level No. of cycles
Normal	Compensation		Backing	Grid		
-20~+200°C	+10~+100°C	CN/NP-50B/C-1	Polyimide	Cu-Ni	3% (30,000)	±1,500μE 1x10 ⁶

HIGH TEMPERATURE USE

ZF series strain gauges P.55

These strain gauges are designed for measurement in high temperature up to 300°C. They utilize specially designed Ni-Cr alloy foil for the grid and polyimide resin for the gauge backing. Owing to the construction, these strain gauges are successfully used for measurement in high temperature.

Operating temperature		Bonding adhesive	Materials		Strain limit (μE)	Fatigue life Strain level No. of cycles
Normal	Compensation		Backing	Grid		
-20~+300°C	+10~+100°C	CN/NP-50B/C-1	Polyimide	Ni-Cr	1% (10,000)	±1,500μE 1x10 ⁶

HIGH TEMPERATURE USE

EF Series strain gauges P.56

These are polyimide backing strain gauges for high temperature use. The gauges have a miniature grid pattern required as strain gauges to measure the mechanical properties of printed circuit boards and mounting parts which are getting smaller.

Operating temperature		Bonding adhesive	Materials		Strain limit (μE)	Fatigue life Strain level No. of cycles
Normal	Compensation		Backing	Grid		
Single element (EFLA)						
-196~+300°C	+10~+150°C	CN/EB-2 NP-50B/C-1	Polyimide	Ni-Cr	1% (10,000)	±1,500μE 1x10 ⁶
2-/3-element (EFCA/EFRA)						
-196~+200°C	0~+150°C	CN/EB-2 NP-50B/C-1	Polyimide	Ni-Cr	1% (10,000)	±1,500μE 1x10 ⁶

HIGH & LOW TEMPERATURE USE

CEF series strain gauges P.56

These are strain gauges utilizing polyimide resin for the gauge backing and special alloy foil for the grid. These feature a wide range of operating temperature from cryogenic temperature to +200°C. This series is available only in single axis configuration with gauge length of 1,3 and 6mm.

Operating temperature		Bonding adhesive	Materials		Strain limit (μE)	Fatigue life Strain level No. of cycles
Normal	Compensation		Backing	Grid		
-269~+200°C	-196~+80°C	CN/C-1 EA-2A	Polyimide	Special alloy	1% (10,000)	±1500μE 1x10 ⁶

CRYOGENIC TEMPERATURE USE

CF series strain gauge P.57

These are foil strain gauges with epoxy backing designed for measurement under cryogenic conditions. These are available in single element, rectangular 2-element and 45° rectangular 3-element configurations with 350Ω resistance. The specially selected and heat treated grid of these gauges shows very small zero shift under cryogenic temperature compared to conventional strain gauges.

Operating temperature		Bonding adhesive	Materials		Strain limit (μE)	Fatigue life Strain level No. of cycles
Normal	Compensation		Backing	Grid		
-269~+80°C	-196~+80°C	CN/C-1 EA-2A	Special plastics	Special alloy	1% (10,000)	±1,500μE 1x10 ⁶

WELDABLE TYPE

AW series strain gauges P.59

These strain gauges have strain sensing elements fully encapsulated in corrosion-resisting metal tubes made of stainless steel or Inconel (except AW-6-350). The strain gauge backings are also made of the same material, and the gauges are installed by spot welding to metal specimens using a dedicated spot welder. The maximum operating temperature is 800°C for the AWHU. These gauges are suited to measurement in high temperature, harsh environments such as underwater or gas-filled atmosphere, or for a long period of time. The AWC-2B and AWCH-2 adopt 1-gauge 4-wire strain measurement method.

AWM-8  Quarter bridge with 3-wire system

Operating temperature		Materials		Strain limit (μE)	Fatigue life Strain level No. of cycles
Normal	Compensation	Backing	Grid		
-196~+300°C	RT~+ 300°C (RT: Room Temp.)	SUS304 Inconel	Special alloy	1% (10,000)	±1,000μE 1x10 ⁶

AWMD-5, AWMD-8  Full bridge for dynamic measurement

Operating temperature		Materials		Strain limit (μE)	Fatigue life Strain level No. of cycles
Normal	Compensation	Backing	Grid		
-196~+800°C	N/A	SUS304 Inconel	Special alloy	1% (10,000)	±1,000μE 1x10 ⁶

AWH-4, AWH-8  Full bridge for static measurement
Full bridge for dynamic measurement

Operating temperature		Materials		Strain limit (μE)	Fatigue life Strain level No. of cycles
Normal	Compensation	Backing	Grid		
Static measurement -196~+600°C	Static measurement RT~+ 600°C	SUS321 Inconel	Special alloy	0.6% (6,000)	±1,000μE 1x10 ⁶
Dynamic's -196~+650°C	Dynamic's RT~+ 650°C				

WELDABLE TYPE

AW series strain gauges

P.62



AWHU-5, AWHU-8

Full bridge for static & dynamic

Operating temperature		Materials		Strain limit (μE)	Fatigue life Strain level No. of cycles
Normal	Compensation	Backing	Grid		
For static/dynamic -196~+800°C	RT~+ 800°C	Inconel	Special alloy	1% (10,000)	±1,000μE 1x10 ⁶

AW-6-350-11-4FB01LT Quarter bridge with 3-wire system

Operating temperature		Materials		Strain limit (μE)	Fatigue life Strain level No. of cycles
Normal	Compensation	Backing	Grid		
-196~+300°C	+10~+100°C	SUS304	Special	0.5% (5,000)	±1,000μE 1x10 ⁶

AWC-2B-11-3LQSA 1-Gauge 4-Wire

Operating temperature		Materials		Strain limit (μE)	Fatigue life Strain level No. of cycles
Normal	Compensation	Backing	Grid		
-20~+100°C	0~+100°C	SUS304	Special	0.5% (5,000)	±1,000μE 1x10 ⁶

AWC-8B-11-3LTSB Quarter bridge with 3-wire system

Operating temperature		Materials		Strain limit (μE)	Fatigue life Strain level No. of cycles
Normal	Compensation	Backing	Grid		
-20~+100°C	+10~+100°C	SUS304	Special	0.5% (5,000)	±1,000μE 1x10 ⁶

AWCH-2-11-MI2L-05LQSA 1-Gauge 4-Wire

Operating temperature		Materials		Strain limit (μE)	Fatigue life Strain level No. of cycles
Normal	Compensation	Backing	Grid		
-196~+200°C	0~+150°C	SUS304	Special	0.5% (5,000)	±1,000μE 1x10 ⁶

CONCRETE MATERIAL USE

P series Polyester wire strain gauges

P.65



These are wire strain gauges utilizing a transparent plastic backing impregnated with polyester resin. The gauge length is available in 3 steps of 60, 90 and 120mm, so it is suited to the measurement of concrete strain. Since the backing is transparent, the bonding position can easily be checked in the installation works.

Operating temperature		Bonding adhesive	Materials		Strain limit (μE)	Fatigue life Strain level No. of cycles
Normal	Compensation		Backing	Grid		
-20~+80°C	+10~+80°C	CN-E RP-2,PS	Polyester	Cu-Ni wire	2% (20,000)	±1,000μE 1x10 ⁵

PF series Polyester foil strain gauges

P.65



These are foil strain gauges utilizing a polyester resin backing which is the same as the P series. The gauge length is available in 3 steps of 10, 20 and 30mm, so it is suited mainly to strain measurement on concrete or mortar. The backing is transparent and the installation is easy.

Operating temperature		Bonding adhesive	Materials		Strain limit (μE)	Fatigue life Strain level No. of cycles
Normal	Compensation		Backing	Grid		
-20~+80°C	+10~+80°C	CN-E, PS RP-2	Polyester	Cu-Ni	2% (20,000)	±1,500μE 1x10 ⁵

FLM/WFLM series Metal backing strain gauges

P.66



These strain gauges have thin stainless steel backings which prevent the penetration of moisture from the reverse sides. These constructions are aimed for successful strain measurement on concrete surface. The WFLM gauges have moisture proofing over-coating and integral leadwire in addition to the stainless steel backing. These are intended for long term measurement or measurement on underwater-curing concrete.

Operating temperature		Bonding adhesive	Materials		Strain limit (μE)	Fatigue life Strain level No. of cycles
Normal	Compensation		Backing	Grid		
-20~+80°C	+10~+80°C	PS	SUS304	Ni-Cr	0.5% (5,000)	±1,000μE 1x10 ⁵

PM series Mold strain gauge Embedment type

P.66



These gauges are designed exclusively for the measurement of internal strain of concrete or mortar under loading test. These are embedded into the measurement position when the concrete or mortar is placed. These gauges have a construction of the sensing element sealed into the backing made of acrylic resin for waterproofing.

Operating temperature		Bonding adhesive	Materials		Strain limit (μE)	Fatigue life Strain level No. of cycles
Normal	Compensation		Backing	Grid		
-20~+60°C	N/A	Embedment	Acrylic	Cu-Ni wire	N/A	N/A

PMF series Mold strain gauge Embedment type

P.68



These gauges are designed for the measurement of internal strain of concrete or mortar under loading test. These can also be used for short-term measurement of the behavior of concrete. These are embedded into the measurement position when the concrete or mortar is placed. These employ super engineering plastics as the backing for sealing the sensing element, which provides excellent waterproofing. A temperature-integrated type PMFL-T is available for measurement of both strain and temperature using our data loggers.

*For long-term measurement of concrete structures, the use of Strain Transducer KM is recommended.

Operating temperature		Bonding adhesive	Materials		Strain limit (μE)	Fatigue life Strain level No. of cycles
Normal	Compensation		Backing	Grid		
-20~+60°C	N/A	Embedment	Special plastics	Cu-Ni foil	N/A	N/A

CONCRETE MATERIAL CIVIL ENGINEERING USE

KM Strain Transducer



P.69



The KM series are embedment type transducers designed for measurement of internal strain of materials such as concrete and synthetic resin not only in their hardened state but also in curing process. The apparent elastic modulus is as low as approx. 40N/mm², and they are ideally suited to strain measurement during the very early stage of curing (except KM-A and KM-AT). They are totally impervious to moisture absorption producing excellent stability for long-term strain measurement. The KM-100B and KM-100BT are also applicable to measurement of surface strain of steel or concrete structures by using optional collars for surface installation.

The KM series are compliant to CE marking except for KM-30 and KM-50F.

ASHPHALT USE, EMBEDMENT TYPE

PMFLS series Asphalt Mold strain gauges

P.68



The gauges are embedded in asphalt and used for strain measurement in loading test such as rolling compaction. The material of the backing is super engineering plastics featuring high temperature resistivity and waterproofing performance. The gauges withstand a high temperature up to 200°C during placement of asphalt, while the operating temperature range is -20 to +60°C.

Operating temperature		Bonding adhesive	Materials		Strain limit (μE)	Fatigue life Strain level No. of cycles
Normal	Compensation		Backing	Grid		
-20~+60°C	N/A	Embedment	Special plastics	Cu-Ni	N/A	N/A

ASHPHALT PAVEMENT CIVIL ENGINEERING USE

KM-HAS Strain Transducer



P.70



This transducer is embedded into asphalt for measurement of the internal strain. It has flanges with reinforcing bars on its both ends for good fixation to asphalt pavement materials. The operating temperature range of the transducer is -20 to +180°C, and it has a fully waterproof construction.

TML STRAIN GAUGE SELECTION

COMPOSITE MATERIAL USE

UBF series Composite strain gauges

P.71



These are strain gauges developed for measurement on composite materials. These have a specially designed grid pattern to reduce the stiffening effect of the strain gauge. In addition, owing to the development of gauge backing with better compliance, the number of repetition in thermal cycling test and the creep characteristics have been significantly improved compared to conventional strain gauges.

Operating temperature		Bonding adhesive	Materials		Strain limit (µε)	Fatigue life Strain level No. of cycles
Normal	Compensation		Backing	Grid		
Static measurement -30~+120°C	N/A	CN/NP-50B/EB-2	Polyimide amide	Cu-Ni	3% (30,000)	±1,500µε 1x10 ⁶
Dynamic's -30~+150°C						

BF series Composite strain gauges

P.71



These are foil strain gauges designed for measurement on composite materials. These have a specially designed grid pattern to enable small stiffening effect and excellent performance in strain measurement up to 200°C. This series is available with self-temperature-compensation for a material having coefficient of thermal expansion of 3,5 or 8x10⁻⁶/°C. This series is recommended for use on ceramic, carbon and composite materials.

Operating temperature		Bonding adhesive	Materials		Strain limit (µε)	Fatigue life Strain level No. of cycles
Normal	Compensation		Backing	Grid		
-20~+200°C	+10~+80°C	CN/NP-50B/EB-2	Polyimide	Cu-Ni	3% (30,000)	±1,500µε 1x10 ⁶

LOW ELASTIC MODULUS MATERIAL USE

GF series strain gauges for plastics

P.72



These gauges are suited for the measurement on materials such as plastics, which have low elastic modulus compared to metal. The specially designed grid reduces the stiffening effect of the strain gauges to the specimen material, and also reduce the effect of Joule heat in the strain gauges. This series is available with self-temperature-compensation for the material having a coefficient of thermal expansion of 50 or 70x10⁻⁶/°C.

Operating temperature		Bonding adhesive	Materials		Strain limit (µε)	Fatigue life Strain level No. of cycles
Normal	Compensation		Backing	Grid		
-20~+80°C	+10~+80°C	CN	Special plastics	Cu-Ni	3% (30,000)	±1,500µε 1x10 ⁶

LF series strain gauges for wood gypsum

P.73



These are foil strain gauges for the measurement on materials having low elastic modulus such as wood or gypsum. These specially designed grid reduces the stiffening effect of the strain gauges to the specimen material. They have a backing made of epoxy resin. These gauges are temperature-compensated for the material having a coefficient of thermal expansion of 11x10⁻⁶/°C.

Operating temperature		Bonding adhesive	Materials		Strain limit (µε)	Fatigue life Strain level No. of cycles
Normal	Compensation		Backing	Grid		
-20~+80°C	+10~+80°C	CN-E	Special plastics	Cu-Ni	3% (30,000)	±1,500µε 1x10 ⁶

WOOD MATERIAL USE FOR LONG TERM OF PERIOD

PFLW and PLW series strain gauges

P.73



These gauges are specially designed for long term measurement on wood. It has a metal foil lined on the back of the PFL or PL strain gauge. The metal foil is effective to protect the strain gauge from an influence of moisture in the wood.

Operating temperature		Bonding adhesive	Materials		Strain limit (µε)	Fatigue life Strain level No. of cycles
Normal	Compensation		Backing	Grid		
-20~+80°C	+10~+80°C	PS	Polyester	Cu-Ni	2% (20,000)	±1,000µε 1x10 ⁵

MAGNETIC FIELD USE

MF series strain gauges

P.74



These gauges are designed for strain measurement in the magnetic field. The gauges have a sensing element material which exhibits low magnetoresistance. In addition, the sensing element consists of two identical grids with one grid folded back on another. This construction makes the strain gauges less sensitive to the influence of the alternating field. These gauges have a twisted leadwire pre-attached which is also effective to avoid the influence of the alternating field. The 2-element and 3-element gauges of this series are usable in high temperature up to 200°C.

Single element with twisted Vinyl leadwire of 1m

Operating temperature		Bonding adhesive	Materials		Strain limit (µε)	Fatigue life Strain level No. of cycles
Normal	Compensation		Backing	Grid		
-20~+80°C	-	CN/CN-E RP-2	Special plastics	Ni-Cr	1% (10,000)	±1,500µε 1x10 ⁶

2- /3-axis element stacked Rosette,

with 3-wire twisted Fluorinated (FEP) resin leadwire of 1m

Operating temperature		Bonding adhesive	Materials		Strain limit (µε)	Fatigue life Strain level No. of cycles
Normal	Compensation		Backing	Grid		
-20~+120°C	-	CN/CN-E NP-50B/EB-2/C-1	Polyimide	Ni-Cr	1% (10,000)	±1,500µε 1x10 ⁶
-20~+200°C						

POST-YIELD (Large strain) MEASUREMENT

YEF series Post-yield strain gauges

(Option -F) CE

P.75



These gauges are applicable to the measurement of large strain up to 10~15%. Also they withstand the repeated strain in elastic range (at strain level ±1500x10⁻⁶) like ordinary strain gauges. However, these are not applicable to the measurement of repeated strain in a large range.

Operating temperature		Bonding adhesive	Materials		Strain limit (µε)	Fatigue life Strain level No. of cycles
Normal	Compensation		Backing	Grid		
-20~+80°C	N/A	CN/CN-Y	Special plastics	Cu-Ni	10~15% (100,000~150,000)	±1,500µε 5x10 ⁵

YF series Post-yield strain gauges

(Option -F) CE

P.75

These gauges are applicable to the measurement of large strain up to 15 to 20%. The gauges are not applicable to the measurement of repeated strain in elastic modulus range as well as in large range.

Operating temperature		Bonding adhesive	Materials		Strain limit (µε)	Fatigue life Strain level No. of cycles
Normal	Compensation		Backing	Grid		
-20~+80°C	N/A	CN/CN-Y	Special plastics	Cu-Ni	15~20% (150,000~200,000)	N/A

YHF series Post-yield strain gauges

(Option -F) CE

P.76

These gauges are developed for the measurement of very large strain up to 30~40%. These are not applicable to the measurement of repeated strain in elastic modulus range as well as in large range.

Operating temperature		Bonding adhesive	Materials		Strain limit (µε)	Fatigue life Strain level No. of cycles
Normal	Compensation		Backing	Grid		
-30~+80°C	N/A	CN/CN-Y	Special plastics	Special alloy	30~40% (300,000~400,000)	±1,500µε 2x10 ⁴

HIGH ENDURANCE STRAIN GAUGE

DSF series strain gauge

CE

P.78



These gauges are designed for fatigue test in high stress level. The gauges satisfy the fatigue life over 10 million times at a strain level of ±3000. These are available for use in cyclic loading test of composite materials.

Operating temperature		Bonding adhesive	Materials		Strain limit (µε)	Fatigue life Strain level No. of cycles
Normal	Compensation		Backing	Grid		
-60~+200°C	N/A	CN/EB-2 C-1	Polyimide	Special alloy	1% (10,000)	±3,000µε 1x10 ⁷

ONE-SIDE STRAIN MEASUREMENT

DD series One-side strain gauges

P.78



These gauges are intended for measuring the bending and tensile strains separately by simply bonding the gauges on one side of a plate or beam. These work on the assumption that the strain distribution in the section of the specimen is linear along the height of the section when the section is subjected to both tensile and bending stress. These gauges are effectively used for the measurement of a box construction in structures such as bridges or pressure vessels, where the reverse side of the measurement object is not accessible for strain gauge installation.

Operating temperature		Bonding adhesive	Materials		Strain limit (με)	Fatigue life Strain level No. of cycles
Normal	Compensation		Backing	Grid		
-10~+70°C	N/A	CN, P-2	Acrylic	Cu-Ni	0.15% (1,500)	±1,000με 1x10 ⁵

CRACK DETECTION GAUGE

FAC series Crack detection gauges



P.79



These gauges are designed to measure the propagation speed of fatigue crack in a metal specimen. The gauges are bonded with an adhesive on the position where the crack is initiated or the crack initiation is expected. The grids of the gauges, which are aligned with interval of 0.1mm or 0.5mm, are disconnected one by one with the propagation of the crack. The gauges are used together with the crack gauge adaptor CGA-120B, and the disconnection of one grid is measured as the change of approx. 45 or 40x 10⁻⁶ strain by a strainmeter.

Operating temperature		Bonding adhesive	Materials		Strain limit (με)	Fatigue life Strain level No. of cycles
Normal	Compensation		Backing	Grid		
-30~+80°C	N/A	CN, RP-2	Special plastics	Cu-Ni	N/A	N/A

STRESS GAUGE

SF series Stress gauges



P.79



These gauges are intended to measure the stress in an optional direction of the specimen in plane stress field. The gauges are sensitive not only in their axial direction but also in their transverse direction, and the sensitivity ratio of the transverse direction to the axial direction is equal to the Poisson's ratio of the specimen material. In addition, the gauges are not sensitive to the shearing strain. Accordingly, the output of the gauges is proportional to the stress in the axial direction. The gauges are available in three types depending on the Poisson's ratio of the specimen material.

Operating temperature		Bonding adhesive	Materials		Strain limit (με)	Fatigue life Strain level No. of cycles
Normal	Compensation		Backing	Grid		
-20~+200°C	+10~+100°C	CN/NP-50B/C-1	Polyimide	Cu-Ni	N/A	±1,500με 1x10 ⁶

**BOLT AXIAL STRAIN MEASUREMENT
EMBEDMENT TYPE**

BTM series Bolt strain gauges



P.83



These gauges are used for measurement of tensile strain of bolt. These are simply inserted into a pre-drilled hole in the bolt head together with A-2 bonding adhesive and cured. The gauge series is recommendable if an ordinary strain gauge cannot be mounted on the bolt surface. Accurate tensile force measurement is possible by calibrating the bolt after installing the bolt gauges.

Operating temperature		Bonding adhesive	Materials		Strain limit (με)	Fatigue life Strain level No. of cycles
Normal	Compensation		Backing	Grid		
-10~+80°C	N/A	A-2	Special plastics	Cu-Ni	0.5% (5,000)	N/A

BTMC series Bolt strain gauges



P.83

The BTMC series is also available for measurement of tensile strain of bolt, while it is designed with tube shape sensing element to be easily bonded by fast-room-temperature curing CN adhesive. Accurate tensile force measurement is possible by calibrating the bolt after installing the bolt gauges.

Operating temperature		Bonding adhesive	Materials		Strain limit (με)	Fatigue life Strain level No. of cycles
Normal	Compensation		Backing	Grid		
-10~+80°C	N/A	CN	Special plastics	Cu-Ni	0.5% (5,000)	N/A

TRANSDUCER-SPECIFIC STRAIN GAUGES

P.81

TML strain gauges are used not only for the purpose of knowing strain/stress but also as sensors for strain gauge type transducers. A strain gauge type transducer converts physical quantity such as load, pressure or displacement into mechanical strain on the strain generating body (elastic body), and the mechanical strain is converted into electrical output using strain gauges mounted on the elastic body. We offer various types of transducer-specific strain gauges featuring highly reliable and stable performance.

TEMPERATURE GAUGE

TF series Temperature gauge

P.80



These gauges are bonded on the specimen surface like ordinary strain gauges, and measure the surface temperature. By combining with the dedicated temperature gauge adaptor (TGA-1A or TGA-1B), actual temperature can be measured easily using a strainmeter.

Operating temperature		Bonding adhesive	Materials		Strain limit (με)	Fatigue life Strain level No. of cycles
Normal	Compensation		Backing	Grid		
-20~+200°C	N/A	CN/NP-50B/C-1	Polyimide	Ni alloy	N/A	N/A

FRICTIONAL STRAIN GAUGES

FGAH-1B Axial Strain Transducer

P.92



This is a transducer to measure the axial strain of the steering tie-rod of a car or the tension rod of a structure. Since frictional strain gauges are used in this transducer, installation is completed and it gets ready for measurement by merely pinching the tie-rod with the transducer, without detaching the tie-rod. In addition, there is no need of technical skill and complicated works for attaching strain gauges on the tie-rod.

**FGDH Frictional Torque Sensor System
(Digital telemetry)**

P.93



This is a sensor system to measure torque on the drive shaft of a car. Frictional strain gauges are used as sensing elements, and installation is completed by merely pinching the shaft with the system. There is no need of detaching the shaft, bonding and wiring strain gauges for the installation. In addition, since a telemetry transmitter with battery is built in the system, measured data are transferred to an exclusive receiver by wireless and output as analog signals. The system is applicable to shafts having diameter of 20mm to 30mm using spacers together, which are available as optional items. For wireless transmission, the FGDH-2A uses 315MHz band extremely low power radio wave while the FGDH-3A uses 2.4GHz band advanced low power radio communication system.

FGMH series Strain Checker

P.95



An ordinary strain gauge picks up the strain generated in the specimen through the adhesive layer. The Strain Checker FGMH picks up the strain through the frictional force working on the contact surface of the frictional strain gauge by pressing the gauge against the structure with magnetic force. The checker can be easily fixed on the position of interest and immediately get ready for strain measurement. The FGMH-1B is a standard type of small and lightweight construction. The FGMH-2A features measurement in a narrow place such as near a welding point. These are for single axis measurement. The FGMH-3A is a 3-element type of 0°/45°/90° rectangular rosette configuration.

PRIMARY INSTALLATIONS - Bonding strain gauges

When bonding the strain gauges, the most suitable adhesive should be selected for each application. A typical installation procedure is described below using the fast-curing adhesive CN.

1. Preparation

The following items are required for bonding and leadwire connection: Strain gauges, bonding adhesive, connecting terminals, test specimen, solvent, cleaning tissue for industrial use, soldering iron, solder, abrasive paper (120 -320 grit), marking pencil, scale, tweezers, extension leadwire, polyethylene sheet, nippers.

2. Positioning

Roughly determine a location on the test specimen where the strain gauge is to be bonded.

3. Surface preparation

Before bonding, remove all grease, rust, paint, etc., from the bonding area to provide a shiny metallic surface. Use abrasive paper to abrade an area somewhat larger than the bonding area uniformly and finely with abrasive paper. Finish the surface with #120 to 180 abrasive paper for steel, or #240 to 320 for aluminium.

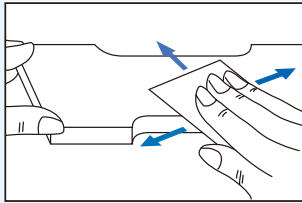

4. Fine cleaning

Clean the abraded surface with industrial tissue or cloth soaked in a small quantity of chemical solvent such as acetone. Continue cleaning until a new tissue or cloth comes away completely free of contamination. Following the surface preparation, be sure to attach the gauge before the surface becomes covered with an oxidizing membrane or becomes newly contaminated.

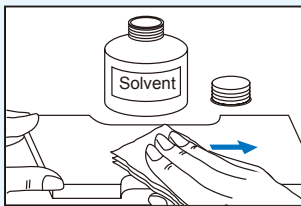

5. Applying bonding adhesive

Drop a proper amount of adhesive onto the back of the gauge base. Usually one drop of adhesive will suffice, but you may increase the number of drops according to the size of the gauge. Use the adhesive nozzle to spread the adhesive over the back surface thinly and uniformly.

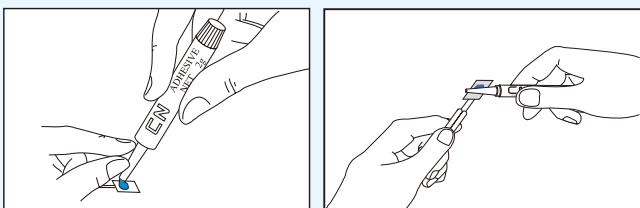

6. Curing and pressing

Place the gauge on the position, place a polyethylene sheet onto it and press down on the gauge constantly using your thumb or a gauge clamp. This should be done quickly as the curing process is completed very fast. The curing time varies depending on the gauge, test specimen, temperature, humidity and pressing force. The curing time under normal conditions is 20-60 seconds.

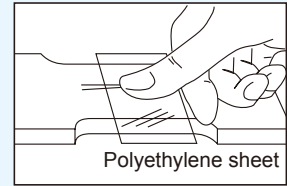

7. Raising gauge leads

After the adhesive beneath the polyethylene sheet has been perfectly cured, raise the gauge leads. Raise the leads up to a bit inside the gauge base. Solder pressing down the foot of the leads by tweezers not to damage the leads..

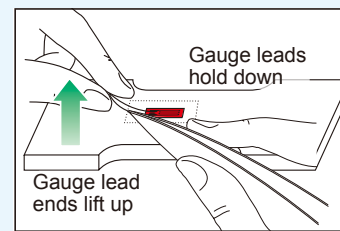

8. Bonding connecting terminals

Bond the terminal close to the gauge base.

Foil type connecting terminals

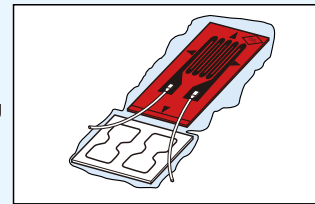

9. Soldering the gauge leads

Place the gauge leads on the gauge terminal with a little slack and apply solder so that the metal foil of terminal is covered with the solder. An excess gauge leads should be twisted off by tweezers.

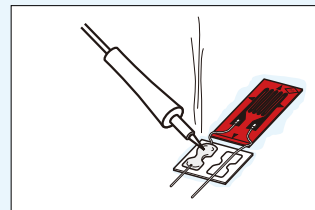

10. Soldering leadwires

It is recommended to plate the exposed core wires of the extension leadwires with solder preliminarily.

Solder the end of leadwire to the terminals. Take care not to excessively heat the terminal to peel off the metal foil.

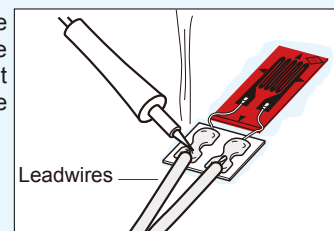

PRIMARY INSTALLATIONS - Overcoating strain gauges

Water- and Moisture-proofing with SB tape and VM tape

Requirement in strain gauge coatings

- Excellent resistance to moisture and water and good electrical insulation
- Good adhesion to the strain gauge, leadwires and test specimen surface
- No constriction of the test specimen

Both of the SB and VM tapes are butyl rubber tape generally referred to as pressure-sensitive adhesive. These coating tapes are applied by being pressed onto the test specimen, and they provide excellent resistance to moisture and water.

SB tape

Butyl rubber
 Temperature : -30 to +80°C
 Contents : 10mm×3mm
 5m long/roll



VM tape

Butyl rubber
 Temperature : -20 to +80°C
 Contents : 38mm×1mm
 6m long/roll



Example for leadwire integrated strain gauge

First coating with SB tape

Trimming the SB tape

With scissors, cut off one piece of tape large enough to cover the coating area and another piece 5mm to 10mm in length to fit under the leadwires.



Under-laying

Lift up the leadwires and press the smaller piece of tape onto the test specimen surface under the leadwires.



Overall coating

Press the leadwires back down onto the piece of SB tape and then press the larger piece of coating tape down onto the strain gauge.

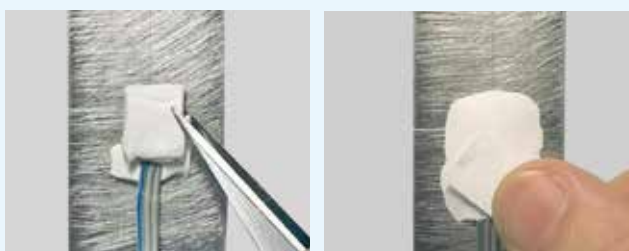

Finish coating with VM tape

Cut a piece of VM tape slightly larger than the layer of SB tape coating and press it down onto the place so that the first coating is fully covered by the VM tape.



STRAIN GAUGE EXTENSION LEADWIRES

Strain gauges are connected to strain measuring instruments using extension leadwires. We offer various types of leadwires to be selected depending on the usage conditions. In addition, most of TML strain gauges are available with extension leadwires preattached at our factory. Those leadwire-integrated strain gauges greatly save the leadwire connection works during the strain gauge installation. Please feel free to contact TML or local representative for the extension leadwires and the leadwire-integrated strain gauges.

Standard leadwire length for leadwire-integrated strain gauges

Standard length of our integral leadwires is 1m, 3m and 5m except enamel leadwires. The standard length of enamel leadwires are 0.3m, 0.5m and 1m. Other lengths than the standard length may be available on request. The enamel leadwires are not available in a length more than 1m.

•OPTION -F Leadwire with CE marking

Leadwire with CE marking (compliant to RoHS2 Directive)

Identification code “-F” is appended to the type number of the leadwire.

Leadwire selection

¶ Vinyl leadwires

Vinyl leadwires are widely used as strain gauge leadwires, and are available in a variety of types. Because the vinyl insulation can be colored, these wires allow color-coding for rosette gauges. Stranded core wires are flexible and easy to handle, and allow easy wire connection and terminal attachment.

•Small diameter vinyl wires (Code to order -LH, -LHT)

These leadwires feature a thin vinyl insulated materials and small diameter core wires to achieve an outside diameter of 0.4mm. They are used for wiring in tight spaces. The stranded wires are flexible and minimize breakage due to repeated bending.



•Shielded vinyl wires (Code to order -LTSA, -LTSB)

These are 3-core wires with shield made of aluminium foil or braided copper wire. The outer insulation is made of vinyl. These leadwires offer a noise shielding function.

Type number of leadwires (Option code -F for CE marking)	Core/Diameter (cross section)	Applicable temperature	Total resist- ance of lead wire	Outer insulated dimensions	Length per roll	Colors
0.08mm ² paralleled vinyl lead wire LJB/LJB-F 	7/0.12 (0.08mm ²)	-20 ~+80°C	0.44Ω/m	1.1 x 2.2mm	200m for Red	Red, White, Green, Black, Yellow Blue, Red-White
0.08mm ² 3-wire paralleled vinyl leadwire LJBT/LJBT-F 				1.1 x 3.3mm	400m for others	White wire and whichever color Blue, Orange, Red, Green, Black or Yellow stripe is selectable.(*)
0.08mm ² twisted vinyl leadwire LJA 	7/0.12 (0.08mm ²)	-20 ~+80°C	0.44Ω/m	φ 1.6mm	-	Red, Green, Yellow
0.08mm ² 3-wire twisted vinyl leadwire LJAT 				φ 1.9mm		Red-Green-Yellow, Red- Green-Blue, Red-Green-White
0.11mm ² paralleled vinyl lead wire LJC/LJC-F 	10/0.12 (0.11mm ²)	-20 ~+80°C	0.32Ω/m	1.4 x 2.8mm	200m	Grey
0.11mm ² 3-wire paralleled vinyl leadwire LJCT/ LJCT-F 				1.4 x 4.2mm	100m	Grey, One wire with Blue stripe (*)
0.3mm ² paralleled vinyl leadwire LJD 	12/0.8 (0.3mm ²)	-20 ~+80°C	0.12Ω/m	1.9 x 3.8mm	200m	Grey
0.3mm ² 3-wire paralleled vinyl leadwire LJDT 				1.9 x 5.7mm	100m	White, One wire with Red stripe (*)
0.5mm ² paralleled vinyl leadwire LJG 	20/0.8 (0.5mm ²)	-20 ~+80°C	0.07Ω/m	2.5 x 5.0mm	100m	Grey
0.5mm ² 3-wire paralleled vinyl leadwire LJGT 				2.1 x 6.3mm		White, One wire with Blue stripe (*)
0.02mm ² twisted vinyl leadwire LH 	5/0.07 (0.02mm ²)	-20 ~+100°C	1.8 Ω/m	φ 0.8mm	-	Red, Green, White
0.02mm ² 3-wire twisted vinyl leadwire LHT 				φ 1.0mm		Red-Green-White
3.2mm-dia. 2-core shielded vinyl leadwire LS 	7/0.12 (0.08mm ²)	-20 ~+80°C	0.44Ω/m	φ 3.2mm	200m	Outer : Red, White or Green Core wire : Red-Black-White
3mm-dia. 3-core shielded vinyl leadwire LTSA 	7/0.12 (0.08mm ²)	-20 ~+80°C	0.1 Ω/m	φ 3mm	200m	Outer insulated: Black Core wire insulated: Red- Black-White
5mm-dia. 3-core shielded vinyl leadwire LTSB 	7/0.26 (0.3mm ²)	-20 ~+80°C	0.1Ω/m	φ 5mm	200m	White, One wire with Red, Blue or Black stripe (*)
0.08mm ² polypropylene 4-wire paralleled leadwire LQM/LQM-F 	7/0.12 (0.08mm ²)	-20 ~+100°C	0.44Ω/m	0.9 x 4.0mm	200m	White, One wire with Red stripe (*)

N.B.: * Stripe is for distinction of independent wire in quarter bridge.

STRAIN GAUGE EXTENSION LEADWIRES

Type number of leadwires (Option code -F for CE marking)	Core/Diameter (cross section)	Applicable temperature	Total resist- ance of lead wire	Outer insulated dimensions	Length per roll	Colors
0.08mm ² vinyl 4-wire paralleled leadwire LBQM/ LBQM-F 	7/0.12 (0.08mm ²)	-20 ~+80°C	0.44Ω/m	1.0 x 4.0mm	200m	
3-wire paralleled special vinyl leadwire LXT/ LXT-F 	7/0.12 (0.08mm ²)	-20 ~+150°C	0.44Ω/m	0.9 x 2.7mm	200m	Red-Black-White

¶ Enamel leadwires

Enamel leadwires have a single core insulated with a resin. Heat resistance and handling methods vary depending on resin. Because the wire mass and diameter are small, enamel leadwires are used for strain measurement of rotating specimens and/or measurement of multiple points located in close proximity. Since the enamel leadwire contains one core covered with a thin resin, it must be handled with care.

•Polyurethane leadwires





Polyurethane leadwires allow easy post-processing because the resin can be removed with a soldering iron. The resin is not strong, therefore, polyurethane wires must be handled with special care.

•Polyester leadwires

Polyester leadwires are harder than polyurethane wires, it cannot be removed with a soldering iron.

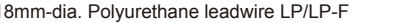
•Polyimide leadwires

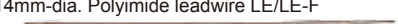
Polyimide leadwires are harder than the polyester wire. A soldering iron cannot be used for post-processing.)



Leadwire type	Core/Diameter	Applicable temperature	Total resistance of leadwire	Outer insulated dimensions	Colors
0.14mm-dia. Polyurethane leadwire LP/LP-F 	1/0.14	-10 ~+120°C	2.5Ω/m	φ 0.16mm	Red, Brown, Green
0.18mm-dia. Polyurethane leadwire LP/LP-F 	1/0.18		1.5Ω/m	φ 0.20mm	
0.14mm-dia. Polyester leadwire LU/LU-F 	1/0.14	-196 ~+200°C	2.5Ω/m	φ 0.16mm	Brown
0.18mm-dia. Polyester leadwire LU/LU-F 	1/0.18		1.5Ω/m	φ 0.20mm	
0.14mm-dia. Polyimide leadwire LE/LE-F 	1/0.14	-269 ~+300°C	2.5Ω/m	φ 0.16mm	Brown
0.18mm-dia. Polyimide leadwire LE/LE-F 	1/0.18		1.5Ω/m	φ 0.20mm	

¶ Cross-linked Vinyl leadwires

The cross-linked vinyl insulation provides improved resistance against environmental elements. It is often used for underwater measurement in ordinary temperature.



¶ Cross-linked Polyethylene leadwires

The cross-linked polyethylene leadwire offers higher durability than the cross-linked vinyl leadwire. Cross-linked polyethylene leadwires can be used in steam, warm water and concrete with virtually no insulation degradation.

Leadwire type	Core/Diameter (Cross section)	Applicable temperature	Total resistance of leadwire	Outer insulated dimensions	Length per roll	Colors
2-wire twisted cross-linked vinyl leadwire LJRA 	7/0.16 (0.14mm ²)	-20 ~+100°C	0.24Ω/m	φ 3.0mm		White
3-wire twisted cross-linked vinyl leadwire LJRTA 	7/0.127 (0.09mm ²)		0.4Ω/m	φ 2.0mm	200m	Red-Green-Black
3-wire twisted cross-linked polyethylene leadwire LJQTA 	7/0.127 (0.09mm ²)	-60 ~+125°C	0.4Ω/m	φ 2.0mm		Red-Yellow-Black Red-Yellow-Blue Red-Yellow-White

¶ Special leadwire for temperature-integrated gauge







Special leadwire for temperature-integrated gauge consists of 2-core copper and 1-core constantan. To extend this wire, the exclusive leadwire should be applied properly.

Leadwire type	Core/Diameter (Cross section)	Applicable temperature	Total resistance of leadwire	Outer insulated dimensions	Length per roll	Colors
Temperature-integrated 3-wire paralleled vinyl lead wire TLJBT/TLJBT-F 	7/0.12 (0.08mm ²)	-20 ~+80°C	0.44Ω/m	1.2x3.6mm		Red-White-Blue
Temperature-integrated 4-wire paralleled vinyl leadwire TLQ 	7/0.12 (0.08mm ²)	-20 ~+80°C	0.44Ω/m	1.2x4.8mm		Red-Green-White-Blue
Temperature-integrated 3-wire twisted fluorinated resin (FEP) leadwire 6FB_TLT 	1/0.2	-269 ~+200°C	1.05Ω/m	φ 1.1mm		Red-White-Blue

STRAIN GAUGE EXTENSION LEADWIRES

¶ Fluorinated resin leadwire

With a fluorinated resin leadwires, these leadwires can be used in a wide range of temperature from extremely low to high temperatures. Fluorinated resin resists most chemicals. A surface treatment (tetra-etching) is not required by 6FAS_LT(-F).

Leadwire type	Core/Diameter (Cross section)	Applicable temperature	Total resistance of leadwire	Outer insulated dimensions	Length per roll*1	Suffix code of leadwire	Colors
3-wire twisted fluorinated resin (FEP) insulated leadwire 6FA_LT/6FA_LT-F 	7/0.18 (0.18mm ²)	-269 ~+200°C	0.2Ω/m	φ 2.0mm	100m	-6FA_LT*2	Red-Green-Blue
3-wire twisted fluorinated resin (FEP) insulated leadwire 6FAS_LT/6FAS_LT-F 	7/0.18 (0.18mm ²)	-269 ~+200°C	0.2Ω/m	φ 2.0mm	100m	-6FAS_LT	
3-wire twisted fluorinated resin (FEP) insulated leadwire 6FB_LT/6FB_LT-F 	1/0.2 (0.09mm ²)	-269 ~+200°C	1.2Ω/m	φ 1.1mm		-6FB_LT	Red-Green-Blue
3-wire twisted fluorinated resin (FEP) insulated leadwire 6FC_LT/6FC_LT-F 	7/0.08 (0.04mm ²)	-269 ~+200°C	1.1Ω/m	φ 1.0mm		-6FC_LT	Red-Black-White
3-wire twisted fluorinated resin (FEP) insulated leadwire 6FD_LTS/6FD_LTS-F 	7/0.08 (0.04mm ²)	-269 ~+200°C					
3-wire twisted fluorinated resin (PTFE) insulated leadwire 4FA_LT/4FA_LT-F 	7/0.16 (0.14mm ²)	-269 ~+260°C *3	0.24Ω/m	φ 1.9mm	100m	-4FA_LT*4	Red-Grey-White
3-wire twisted fluorinated resin (PTFE) insulated leadwire 4FB_LT/4FB_LT-F 	1/0.2	-269 ~+260°C	1.05Ω/m	φ 1.1mm		-4FB_LT*4	Red-Black-White

N.B.: *1 : Leadwires are sold by one roll each *2 : _LT is filled with required length *3 : PTFE leadwire is available in 300°C for short-term use. *4 : Suffix code LT (CT) is provided with connecting terminal joint, and another LT(TA) with insulation film

HOW ARE INTEGRAL LEADWIRES JOINED

Most TML strain gauges are available with extension leadwires pre-attached for customer convenience. We have several methods for connecting leadwires to be chosen depending on conditions such as the type of strain gauge and leadwire, measurement environments and so on.

Different joints

•Integral type

A vinyl leadwire is jointed to polyimide insulaed gauge leads of a strain gauge. The solder joints are covered with the vinyl insulation of the leadwire. This is our standard method of integral leadwire attachment.

•Heat-shrinkable tubing

A soldered joint between gauge leads and leadwire is protected with a heat shrinkable tube. The heat shrinkable tubes are available in three ratings of temperature among 80°C, 200°C and 260°C.

•Connecting terminals joint type



Gauge leads and leadwires are jointed using foil shape connecting terminals. Measurement in high temperature is possible by using a high temperature solder with melting point of 300°C or more for the joint.

•Insulation film type

A soldered joint between gauge leads and leadwires is covered with an insulation film of glass cloth base. The film is resistive to heat up to 300°C, so this method is suited to measurement in high temperature.

•Direct type

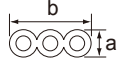
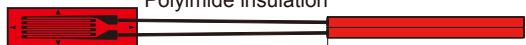
A vinyl leadwire is jointed directly to gauge leads, which are made of nickel plated copper. The solder joints are covered with vinyl insulation of a leadwire up to the end of the gauge base.

Integral type	Cross section 	Leadwire			Code to order	
		Construction	Dimension			
			a	b		
Vinyl leadwire 2-wire 	Polyimide insulation Gauge lead length approx. 15mm	2-wire paralleled	7/0.12	1.1	2.2	-LJB/-LJB-F
		2-wire twisted	10/0.12	1.4	2.8	-LJC/-LJC-F
Vinyl leadwire 3-wire 		2-wire twisted	7/0.12	0.8	-	-LJA
		3-wire paralleled	5/0.07	0.4	-	-LH
		3-wire paralleled	7/0.12	1.1	3.3	-LJBT/-LJBT-F
		3-wire twisted	10/0.12	1.4	4.2	-LJCT/-LJCT-F
		3-wire twisted	7/0.12	0.8		-LJAT

HOW ARE INTEGRAL LEADWIRES JOINTED

Heat-shrinkable tubing		Cross section		Leadwire		Heat-shrinkable tube			Code to order		
				Construction	Dimension		Dimension				
							a	b	L	H	W
Vinyl leadwire	2-wire			12/0.18	1.9	3.8	11	3	6	-LJD	
				20/0.18	2.5	5.0	12	3.5	7	-LJG	
	3-wire			12/0.18	1.9	5.7	11	3	7	-LJDT	
				20/0.18	2.1	6.3	11	3	7	-LJGT	
Cross-linked Vinyl leadwire				Cross-linked vinyl 2-wire twisted	7/0.16	0.9	-	11	2	4	-LJRA
Cross-linked Vinyl leadwire				Cross-linked vinyl 3-wire twisted	7/0.127	0.9	-	11	2	4	-LJRTA
Cross-linked Polyethylene leadwire				Cross-linked polyethylene 3-wire twisted	7/0.127	1.0	-	11	2	4	-LJQTA

Heat-shrinkable tubing		Cross section		Leadwire		Heat-shrinkable tube			Code to order	
				Construction	Dimension	Dimension				
								L	H	W
Gauge lead length approx. 15mm										
3-core shielded Vinyl leadwire	3-wire			7/0.12	ϕ 3.0	10	2	4	-L TSA	
				7/0.26	ϕ 5.0	12.5	3	6	-L TSB	
High temperature use				FEP (Fluorinated-ethylenepropylene) 3-wire twisted	1/0.2	ϕ 1.1	11	2	2	-6FB_LT
Fluorinated resin (FEP) leadwire					7/0.18	ϕ 2.0	11	3	4	-6FA_LT
High temperature use				PTFE (Polytetrafluoroethylene) 3-wire twisted	1/0.2	ϕ 1.1	11	2	2	-4FB_LT
Fluorinated resin (PTFE) leadwire					7/0.16	ϕ 1.9	11	2.5	4	-4FA_LT

Connecting terminals joint type		Leadwire		Code to order	
		Construction	Dimension		
Fluorinated resin (PTFE) leadwire Special construction		PTFE (Polytetrafluoroethylene) 3-wire twisted	7/0.16	ϕ 1.9	-4FA_LT (CT)
3-wire			1/0.2	ϕ 1.1	-4FB_LT (CT)

Insulation film type		Leadwire		Film			Code to order	
		Construction	Dimension	Dimension				
						L	H	W
Fluorinated resin (PTFE) leadwire Special construction		PTFE (Polytetrafluoroethylene) 3-wire twisted	7/0.16	ϕ 1.9	13	1.5	4	-4FA_LT (TA)
3-wire			1/0.2	ϕ 1.1	13	1.5	4	-4FB_LT (TA)

Direct type		Leadwire		Code to order
		Construction	Dimension	
2-wire Vinyl leadwire		Vinyl leadwire 2-wire twisted	7/0.12 ϕ 1.6	-LDA

Figures in Leadwire construction column show "Number of cores/ Diameter of one conductor leadwire in mm". For example, "7/0.12" represents "7core / 0.12mm diameter for one

conductor leadwire". All dimensions of the Leadwire Heat-shrinkable tube and Film are approximate values in mm.

HOW ARE INTEGRAL LEADWIRES JOINTED

Leadwire colors of 3-element Rosette strain gauge

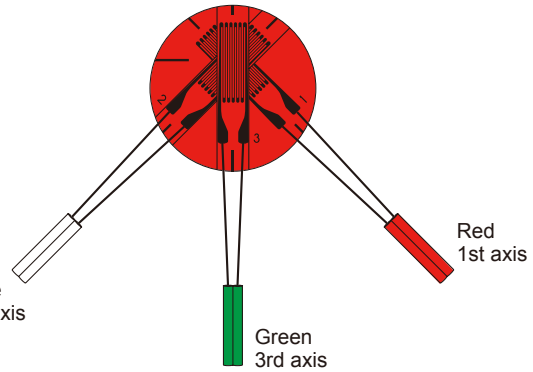
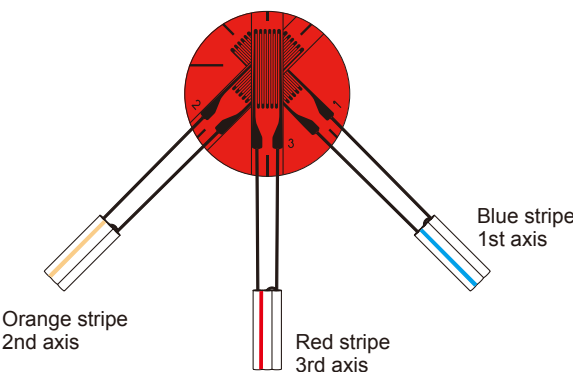
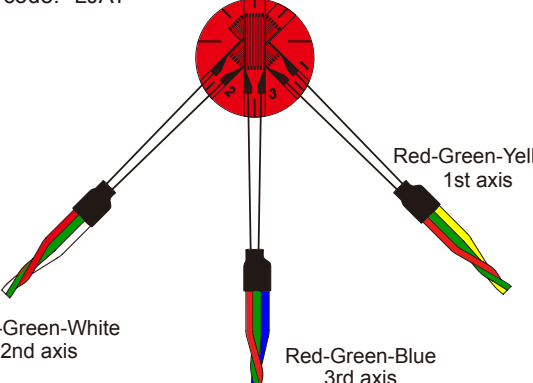
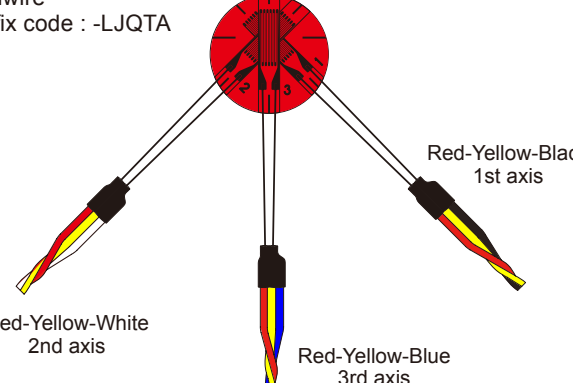
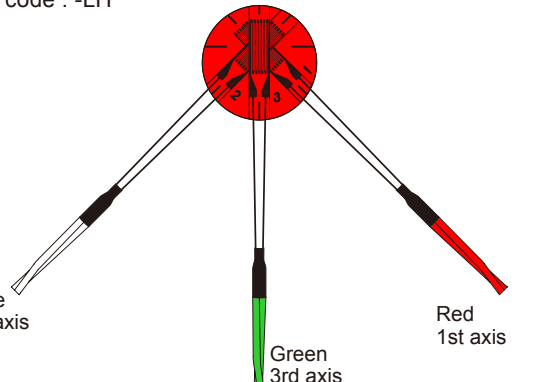
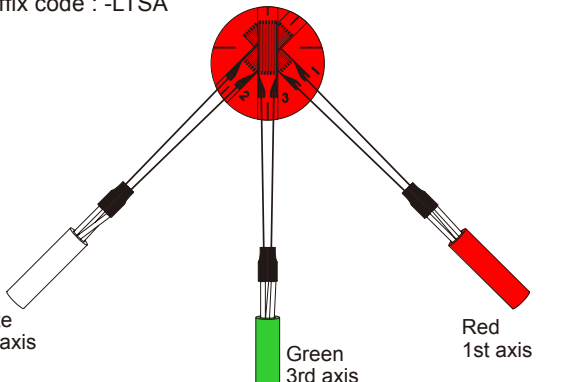
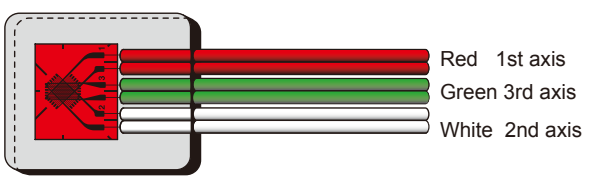
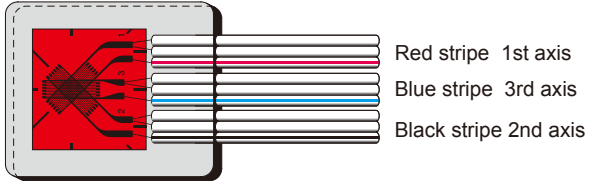
<p>7/0.12 (0.08mm²) Paralleled vinyl leadwire Suffix code : -LJB/-LJB-F</p>  <p>White 2nd axis Green 3rd axis Red 1st axis</p>	<p>7/0.12 (0.08mm²) 3-wire Paralleled vinyl leadwire Suffix code : -LJBT/-LJBT-F</p>  <p>Blue stripe 1st axis Orange stripe 2nd axis Red stripe 3rd axis</p>
<p>7/0.12 (0.08mm²) 3-wire twisted vinyl leadwire Suffix code: -LJAT</p>  <p>Red-Green-White 2nd axis Red-Green-Blue 3rd axis Red-Green-Yellow 1st axis</p>	<p>7/0.127 (0.09mm²) 3-wire twisted cross-linked polyethylene leadwire Suffix code : -LJQTA</p>  <p>Red-Yellow-Black 1st axis Red-Yellow-White 2nd axis Red-Yellow-Blue 3rd axis</p>
<p>5/0.07 (0.02mm²) 2-wire twisted vinyl leadwire Suffix code : -LH</p>  <p>White 2nd axis Green 3rd axis Red 1st axis</p>	<p>3mm-dia. 3-core shielded vinyl leadwire Suffix code : -LTSA</p>  <p>White 2nd axis Green 3rd axis Red 1st axis</p>
<p>7/0.12 (0.08mm²) Paralleled vinyl leadwire Suffix code : -LDBB</p> <p>Waterproof strain gauge</p>  <p>Red 1st axis Green 3rd axis White 2nd axis</p>	<p>7/0.12 (0.08mm²) 3-wire Paralleled vinyl leadwire Suffix code : -LDBTB</p> <p>Waterproof strain gauge</p>  <p>Red stripe 1st axis Blue stripe 3rd axis Black stripe 2nd axis</p>

HOW ARE INTEGRAL LEADWIRES JOINED

Insulated leadwire colors

Stress concentration measurement use
FXV 5-element single axis integrated

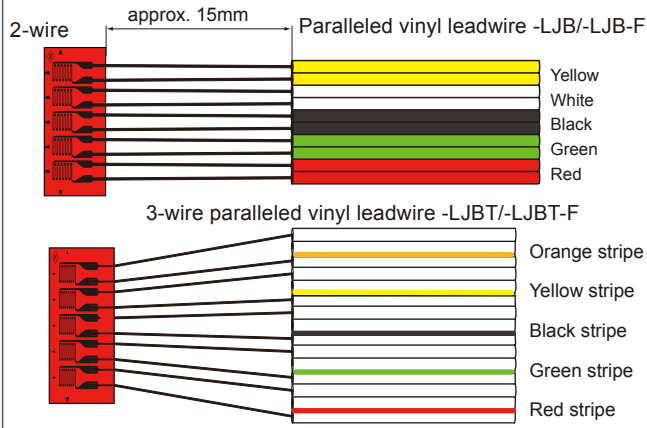

Color stripes are marked on independent wire of each axis with 3-wire system.

FBXV 5-element single axis integrated

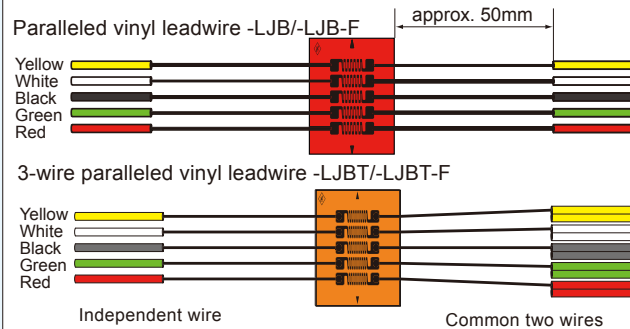

Stress concentration measurement use
FYV 5-element single axis integrated

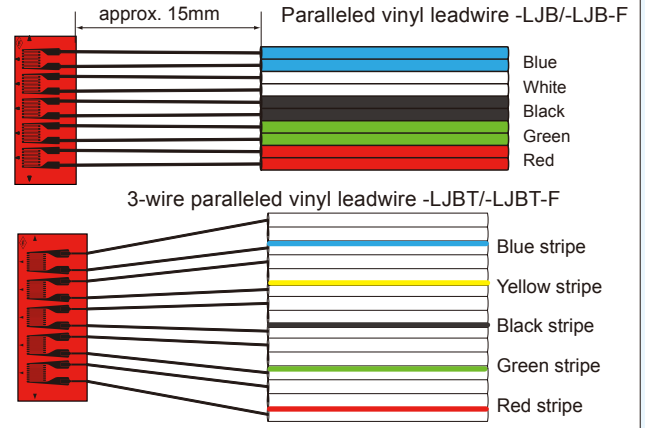

Color stripes are marked on independent wire of each axis with 3-wire system.

FBYV 5-element single axis integrated

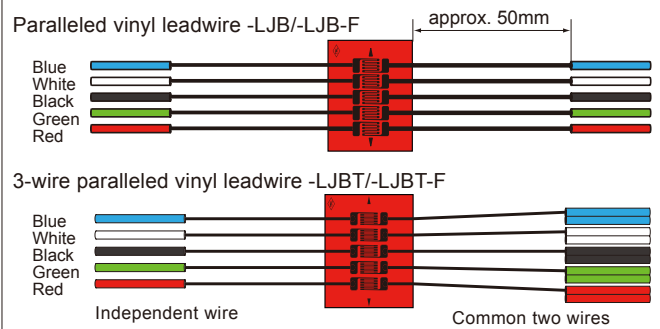

Stress concentration measurement use FCV 10-element 2-axis cross integrated

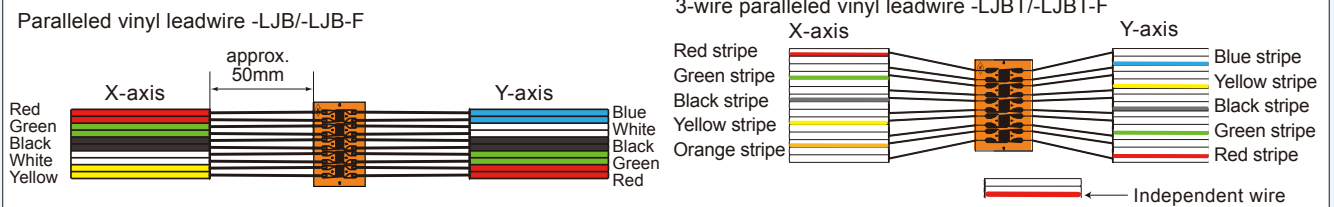

Color stripes are marked on independent wire of each axis with 3-wire system.

Torque measurement use (Integral type) LDBT

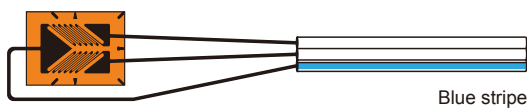

Torque measurement use (Direct type) LDA

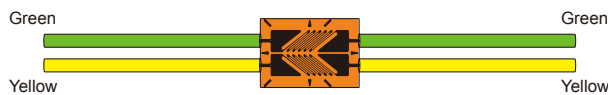

Temperature gauge

TFL (Connecting terminal joint type) -6FB_LT



Color of leadwire insulation may vary depending on the leadwire type.

Single element strain gauge with different leadwire

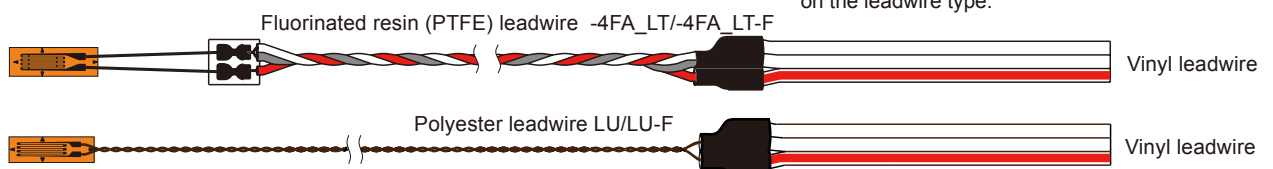

Color of leadwire insulation may vary depending on the leadwire type.

STRAIN GAUGE INSTALLATION

TML strain gauge series are roughly classified into 4 types depending on the method of installation.

1. Adhesive bonding type

In general, most of strain gauges are installed on the surface of test specimen with adhesive. Measurement is possible as far as the specimen material is bondable with adhesive. This method can be applied to various materials including metal, concrete, wood and composite material. After installation, coatings should be applied to protect the strain gauges and leadwires from various environmental conditions. The availability of this bonding type depends on the operating temperature of adhesive. The maximum operating temperature is 300°C.

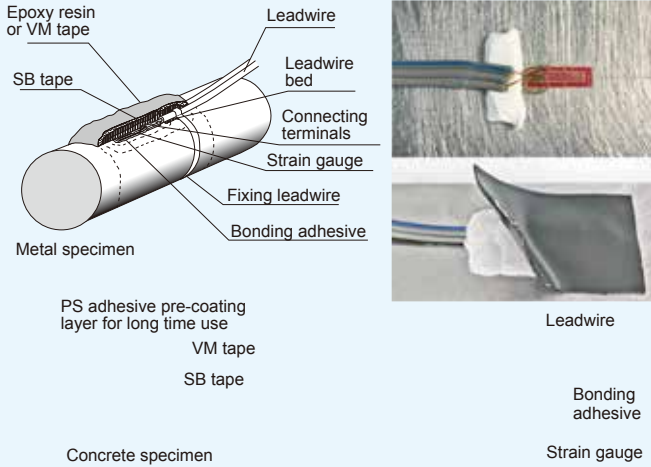

2. Electrical Spot weldable type

The strain gauge of this type is fully encapsulated in a corrosion-resisting metal tube for use in various conditions, such as gas-filled and underwater environments. It is constructed heat resistive, and the installation is made by electrical spot welding which maintains excellent fixation even in high temperature. The operating temperature range is from -196°C to +800°C. The spot welder W-50RB is developed exclusively for installation of strain gauges of this type, and it can be used without any qualifications or special skill. Naturally, the specimen material must be a metal which allows electrical spot welding.

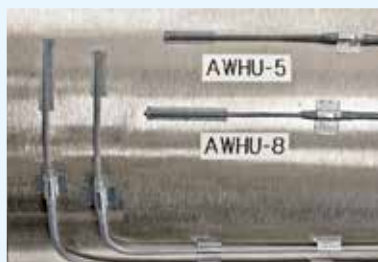
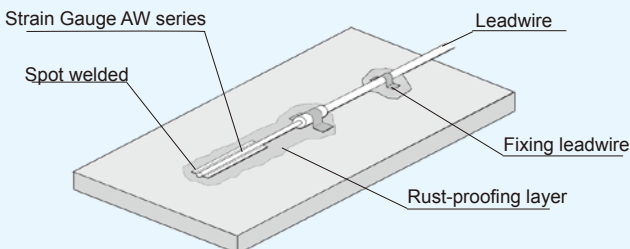

3. Frictional gauge type (Re-usable type)

This gauge consists of a soft rubber layer on its contact surface and a magnet which presses the strain gauge against the specimen surface by magnetic force. It measures strain by friction which is caused between the contact surface of strain gauge and the measurement surface of the metal specimen. It has the advantage of being usable repeatedly because it is attached by magnetic force without using adhesive. Since the measurement point can be moved easily, it is useful for preparatory or supplemental measurement. The maximum operating temperature is 60°C because of adopting magnetic force.

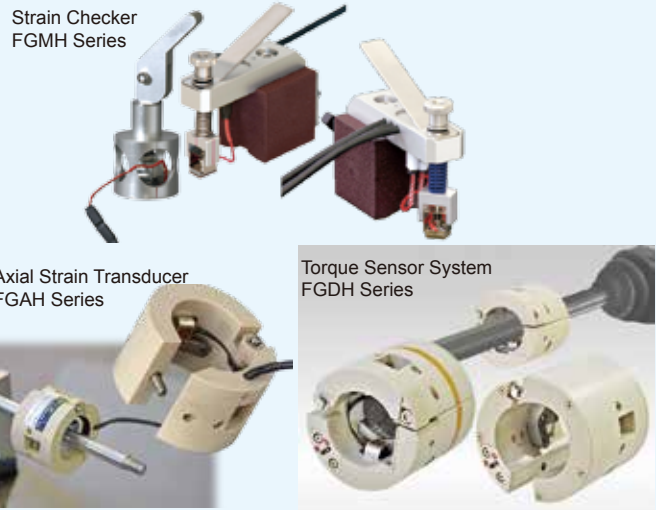
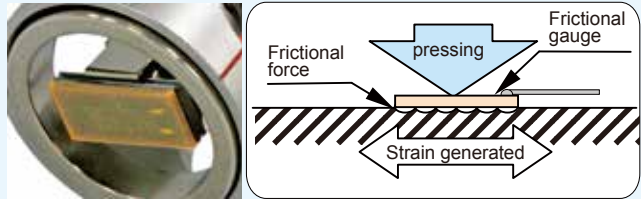

4. Internal strain measurement using embedment type

Above strain gauges of three types measure surface strains of test specimen. This strain gauge measures internal strain of concrete, mortar or asphalt by being embedded into the material before its hardening. It makes possible with measurement in the early stage of hardening of the material. Some series of this type are applicable to measurement in asphalt in high temperature of 200°C. We also have a method to measure axial force of bolt by embedding a bolt strain gauge which is specially prepared for this purpose.

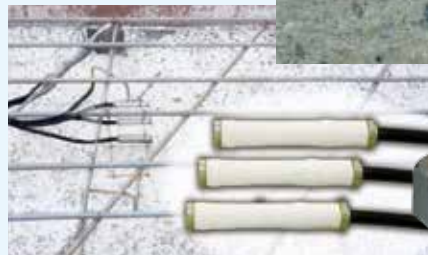
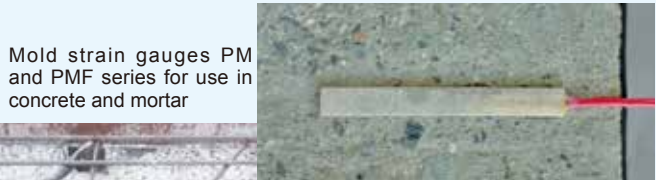

Strain Transducers KM for use in concrete and KM-HAS for use in asphalt pavement



Bolt gauge BTM series installed into bolt with bonding adhesive

STRAIN GAUGE RELATED PRODUCTS



STRAIN GAUGE INSTALLATION TOOL KIT "KIT-51"

The KIT-51 provides all of the necessary tools for bonding strain gauges from surface preparation upto complete wiring, in a single tool box.

■Tools contained

Tool box/ Sponge cushion/ Screwdriver/ Drafting tape/ Tweezers/ Polyethylene sheet/ Nipper/ Solder (melting point 180°C) / Radio pinchers/ Paste for solder/ Measuring tape (2-meter long)/ Numbering plate/ Stainless steel scale/ Fine abrasive paper/ Mending tape/ Protractor/ Wire stripper/ Soldering tip cleaner/ Connecting terminals/ Cutter/ Marking pencil/ Soldering iron/ Compasses/ Scissors/ Acute swab (cotton)/ Heat gun/ AC plug/ Vinyl tape/ Brush for coating works, etc.



T.M.L. STRAIN GAUGE USERS' GUIDE

T.M.L. STRAIN GAUGE PERFORMANCE CHARACTERISTICS

A wide range of T.M.L. strain gauges is available to match diverse measuring conditions. Since strain gauges provide their designed functions only when they are attached to specimens, it is important to select the most appropriate gauge type in consideration of the specimen material type, operating temperature, measurement environment and installation dimensions. The Strain Gauge Users' Guide provide inexperienced users with comprehensive information on strain gauges, covering various subjects ranging from step-by-step strain gauge installation instructions to cautions in handling strain gauges. The Strain Gauge Performance Characteristics compile a guide to the technology of current strain gauge for use in consideration of a limit in detection with regard to the materials and size of a test specimen, humidity, the amount of strain, speed, fatigue, environments, etc.

Combination use of strain gauges and dedicated leadwires

Option -F of strain gauges and last code -F of lead wire are designed with Lead-free, affixing the code to each basic name of strain gauge and leadwire. CE-marked strain gauges, GOBLET and leadwire with -F are designed to comply with CE marking.		LEADWIRE TYPE	0.08mm ² Paralleled vinyl lead wire	0.08mm ² 3-wire paralleled vinyl leadwire	0.08mm ² Twisted vinyl leadwire	0.08mm ² 3-wire twisted vinyl leadwire	0.11mm ² paralleled vinyl leadwire	0.11mm ² 3-wire paralleled vinyl leadwire	0.3mm ² paralleled vinyl leadwire	0.3mm ² 3-wire paralleled vinyl leadwire	0.5mm ² paralleled vinyl leadwire	0.5mm ² 3-wire paralleled vinyl leadwire	0.02mm ² twisted vinyl leadwire	0.02mm ² 3-wire twisted vinyl leadwire	0.08mm ² twisted vinyl leadwire	3.2mm-dia. shielded vinyl leadwire	3mm-dia. shielded 3-wire vinyl leadwire	
		Suffix code	LJB	LJBT	LJA	LJAT	LJC	LJCT	LJD	LJDT	LJG	LJGT	LH	LHT	LJAY	LS	LTSA	
		Last code -F	-F	-F			-F	-F										
		Core/Dimensions	7/0.12	7/0.12	7/0.12	7/0.12	10/0.12	10/0.12	12/0.18	12/0.18	20/0.18	20/0.18	5/0.07	5/0.07	7/0.12	7/0.12	7/0.12	
		Cross section (mm ²)	0.08	0.08	0.08	0.08	0.11	0.11	0.3	0.3	0.5	0.5	0.02	0.02	0.08	0.08	0.08	
Operating temperature in deg. C	-20 ~ +80	-20 ~ +80	-20 ~ +80	-20 ~ +80	-20 ~ +80	-20 ~ +80	-20 ~ +80	-20 ~ +80	-20 ~ +80	-20 ~ +80	-20 ~ +80	-20 ~ +80	-20 ~ +80	-20 ~ +80	-20 ~ +80	-20 ~ +80		
Strain Gauge Series	Operating temperature in deg. C	Temperature compensation in deg. C	Figure shows maximum operating temperature with combination use of strain gauge and the dedicated leadwire.															
F	-196 ~ +150	+10 ~ +100	80	80	80	80	80	80	80	80	80	80	80	80	-	-	80	
	-196 ~ +150	+10 ~ +100	80	80	-	-	80	80	-	-	-	-	-	-	-	-	-	
PF	-20 ~ +80	+10 ~ +100	80	80	-	-	80	80	-	-	-	-	-	-	-	-	-	
P	-20 ~ +80	+10 ~ +100	80	80	-	-	80	80	-	-	-	-	-	-	-	-	-	
FLM	-20 ~ +80	+10 ~ +100	-	80	-	80	-	80	-	80	-	80	-	80	-	-	-	
MF (Single)	-20 ~ +80	-	-	-	80	-	-	-	-	-	-	-	-	-	80	80	80	
(Rosette)	-20 ~ +200	-	-	-	-	-	-	-	-	-	-	-	-	-	80	80	-	
YEF (-F)	-20 ~ +80	-	80	80	80	80	80	80	80	80	80	80	80	80	-	-	-	
YF (-F)	-20 ~ +80	-	80	80	80	80	80	80	80	80	80	80	80	80	-	-	-	
YHF (-F)	-20 ~ +80	-	80	80	80	80	80	80	80	80	80	80	80	80	-	-	-	
LF	-20 ~ +80	+10 ~ +80	80	80	80	80	80	80	80	80	80	80	80	80	-	-	80	
PFLW	-20 ~ +80	+10 ~ +80	80	80	80	80	80	80	80	80	80	80	80	80	-	-	80	
PLW	-20 ~ +80	+10 ~ +80	80	80	80	80	80	80	80	80	80	80	80	80	-	-	80	
GF	-20 ~ +80	+10 ~ +80	80	80	80	80	80	80	80	80	80	80	80	80	-	-	80	
BF	-20 ~ +200	+10 ~ +80	80	80	80	80	80	80	80	80	80	80	80	80	-	-	80	
UBF (Static)	-30 ~ +120	-	80	80	80	80	80	80	80	80	80	80	80	80	-	-	80	
(Dynamic)	-30 ~ +150	-	80	80	80	80	80	80	80	80	80	80	80	80	-	-	80	
DSF	-60 ~ +200	-	80	80	80	80	80	80	80	80	80	80	80	80	-	-	80	
CF	-269 ~ +80	-196 ~ +80	80	80	80	80	80	80	80	80	80	80	80	80	-	-	80	
CEF	-269 ~ +200	-196 ~ +80	80	80	80	80	80	80	80	80	80	80	80	80	-	-	80	
QF	-20 ~ +200	+10 ~ +100	80	80	80	80	80	80	80	80	80	80	80	80	-	-	80	
ZF	-20 ~ +300	+10 ~ +100	80	80	80	80	80	80	80	80	80	80	80	80	-	-	80	
EF (Single)	-196 ~ +300	+10 ~ +150	80	80	80	80	80	80	80	80	80	80	80	80	-	-	80	
(Rosette)	-196 ~ +200	0 ~ +150	80	80	80	80	80	80	80	80	80	80	80	80	-	-	80	
BTM	-10 ~ +80	-	-	-	-	-	-	-	-	-	-	-	-	-	-	-	-	
FAC	-30 ~ +80	-	-	-	-	-	-	-	-	-	-	-	-	-	-	-	-	

The following strain gauges are designed with the specified leadwires. The specifications are checked with this catalog.

Series WF	Operating temperature 0~+80°C	Leadwire : LDBB Paralleled vinyl / LDBTB 3-wire paralleled vinyl 7/0.12(0.08mm ²)
Series WFLM	Operating temperature -20~+80°C	Leadwire : LJQTA 3-wire twisted cross-linked polyethylene 2m 7/0.127(0.09mm ²)
Series PM	Operating temperature -20~+60°C	Leadwire : LJD Paralleled vinyl 2m LJDT 3-wire paralleled vinyl 2m 12/0.18(0.3mm ²)
Series PMF	Operating temperature -20~+60°C	Leadwire : LJRTA 3-wire twisted cross-linked vinyl 2m 7/0.127(0.09mm ²)
	Temperature-integrated PMF	Leadwire : TLJBT 3-wire paralleled vinyl 7/0.12 (0.08mm ²)
Series PMFLS	Operating temperature -20~+60°C	Leadwire : LTSC 4-wire shielded Chloroprene 2m 6mm-diameter

5mm-dia. shielded 3-wire vinyl leadwire	0.08mm ² polypropylene 4-wire parallel lead wire with modular plug	0.08mm ² vinyl 4-wire parallel leadwire	3-wire paralleled special vinyl leadwire	2-wire twisted cross-linked vinyl leadwire	3-wire twisted cross-linked vinyl leadwire	3-wire twisted cross-linked polyethylene leadwire	Temperature-integrated 3-wire parallel vinyl leadwire	Temperature-integrated 4-wire parallel vinyl leadwire	Temperature-integrated 3-wire twisted fluorinated resin (FEP) leadwire	0.14mm-dia. polyurethane leadwire 0.18mm-dia. polyurethane leadwire	0.14mm-dia. polyester leadwire 0.18mm-dia. polyester leadwire	0.14mm-dia. polyimide leadwire 0.18mm-dia. polyimide leadwire	3-wire twisted fluorinated resin (FEP) leadwire	3-wire twisted fluorinated resin (FEP) leadwire	3-wire twisted fluorinated resin (FEP) leadwire	1.5mm-dia. 3-wire twisted fluorinated resin (FEP) leadwire with shield	3-wire twisted fluorinated resin (PTFE) leadwire	3-wire twisted fluorinated resin (PTFE) leadwire	
LTSB	LQM	LBQM	LXT	LJRA	LJRJA	LJQTA	TLJBT	TLQ	6FB _{LT*}	LP	LU	LE	6FA _{LT*}	6FAS _{LT*}	6FB _{LT*}	6FC _{LT*}	6FD _{LTS*}	4FA _{LT*}	4FB _{LT*}
	-F	-F	-F				-F			-F	-F	-F	-F	-F	-F	-F	-F	-F	-F
70.26	70.12	70.12	70.12	70.16	70.127	70.127	70.12	70.12	10/2	1/0.14 1/0.18	1/0.14 1/0.18	1/0.14 1/0.18	70.18	70.18	10/2	70.08	70.08	70.16	10/2
0.3	0.08	0.08	0.08	0.14	0.09	0.09	0.08	0.08					0.18	0.18		0.04	0.04	0.14	
-20 ~ +80	-20 ~ +100	-20 ~ +80	-20 ~ +150	-20 ~ +100	-20 ~ +100	-65 ~ +125	-20 ~ +80	-20 ~ +80	-269 ~ +200	-10 ~ +120	-196 ~ +200	-269 ~ +300	-269 ~ +200	-269 ~ +200	-269 ~ +200	-269 ~ +200	-269 ~ +200	-269 ~ +260	-269 ~ +200

Figure shows maximum operating temperature with combination use of strain gauge and the dedicated leadwire.

80	100	80	150	100	100	100	80	80	150	120	150	150	150	150	150	150	-	150	150	
-	100	80	150	-	-	-	80	-	-	120	150	150	-	-	-	-	-	-	-	
-	80	80	80	-	-	-	80	-	-	80	80	80	-	-	-	-	-	-	-	
-	80	80	80	-	-	-	-	-	-	80	80	80	-	-	-	-	-	-	-	
80	-	-	80	-	80	80	80	80	80	80	80	80	80	80	80	80	80	-	80	80
-	-	-	-	-	-	-	-	-	-	80	80	80	-	-	-	-	80	-	-	
-	-	-	-	-	-	-	-	-	-	120	200	200	-	-	-	-	200	-	-	
	80	80	80	80	80	80	80	80	80	80	80	80	80	80	80	80	80	-	80	80
	80	80	80	80	80	80	80	80	80	80	80	80	80	80	80	80	80	-	80	80
	80	80	80	80	80	80	80	80	80	80	80	80	80	80	80	80	80	-	80	80
80	80	80	80	80	80	80	80	80	80	80	80	80	80	80	80	80	80	-	80	80
80	80	80	80	80	80	80	80	80	80	80	80	80	80	80	80	80	80	-	80	80
80	80	80	80	80	80	80	80	80	80	80	80	80	80	80	80	80	80	-	80	80
80	80	80	80	80	80	80	80	80	80	80	80	80	80	80	80	80	80	-	80	80
80	100	80	150	100	100	125	80	80	200	120	200	200	200	200	200	200	200	-	200	200
80	100	80	120	100	100	120	80	80	120	120	120	120	120	120	120	120	120	-	120	120
			150			125			150	150	150	150	150	150	150	150	150	-	150	150
80	100	80	150	100	100	125	80	80	200	120	200	200	200	200	200	200	200	-	200	200
80	80	80	80	80	80	80	80	80	80	80	80	80	80	80	80	80	80	-	80	80
80	100	80	150	100	100	125	80	80	200	120	200	200	200	200	200	200	200	-	200	200
80	100	80	150	100	100	125	80	80	200	120	200	200	200	200	200	200	200	-	200	200
80	100	80	150	100	100	125	80	80	200	120	200	300	200	200	200	200	200	-	260	260
80	100	80	150	100	100	125	80	80	200	120	200	300	200	200	200	200	200	-	260	260
80	100	80	150	100	100	125	80	80	200	120	200	200	200	200	200	200	200	-	200	200
-	-	-	-	-	-	-	-	-	-	80	-	80	-	-	-	-	-	-	80	80
-	-	-	-	-	-	-	-	-	-	80	-	80	-	-	-	-	-	-	-	-

Standard length of these leadwire is 1m, 3m and 5m. Other lengths than the standard length may be available on request.

* : For fluorinated resin leadwires of FEP and PTFE, underline of suffix code is filled with the length of the leadwire required.

Designation of leadwire-integrated strain gauge exempld

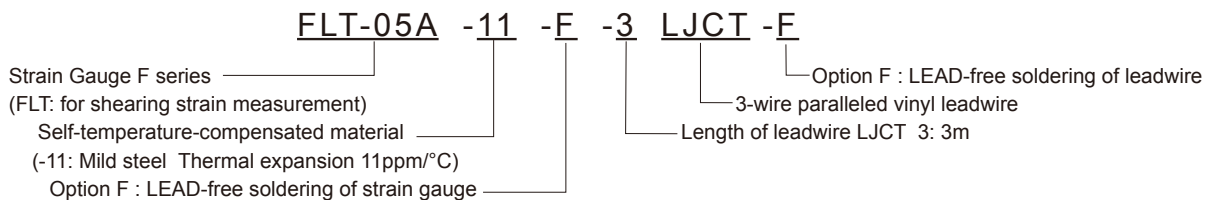



FOIL STRAIN GAUGES

series F

Operating temperature range
 -196°C  +150°C

Temperature compensation range
 +10°C  +100°C



Suffix code for temperature compensation materials
 -11: Mild steel  -17: Stainless steel  -23: Aluminium 

Applicable adhesives

CN	-196 ~ +120°C
P-2	-30 ~ +150°C
EB-2	-60 ~ +150°C

For ordering, the above suffix code should be added to the basic gauge type.

GENERAL USE

Gauge pattern	Basic type	Gauge size		Backing		Resistance Ω
		L	W	L	W	
<p>These gauges employ Cu-Ni alloy foils for the grid and epoxy resin for the backing. The epoxy resin backing exhibits excellent electrical insulation performance, and is color-coded to identify the objective material for self-temperature-compensation. Various types of strain gauges such as "for residual stress measurement" are available in addition to general use gauges.</p> <div style="display: flex; justify-content: space-around; align-items: center;">   </div>						

Example of type number designation

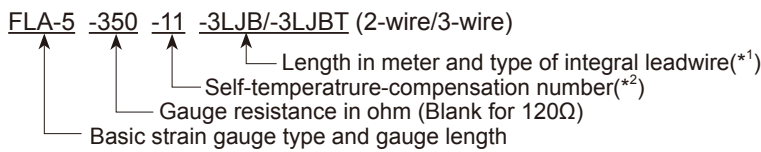

^{*1}: Not mentioned for gauges without leadwire
^{*2}: The following numbers are available for F series gauges
 -11: Mild steel (11ppm/°C)
 -17: Stainless steel, Copper alloy (17ppm/°C)
 -23: Aluminium (23ppm/°C)





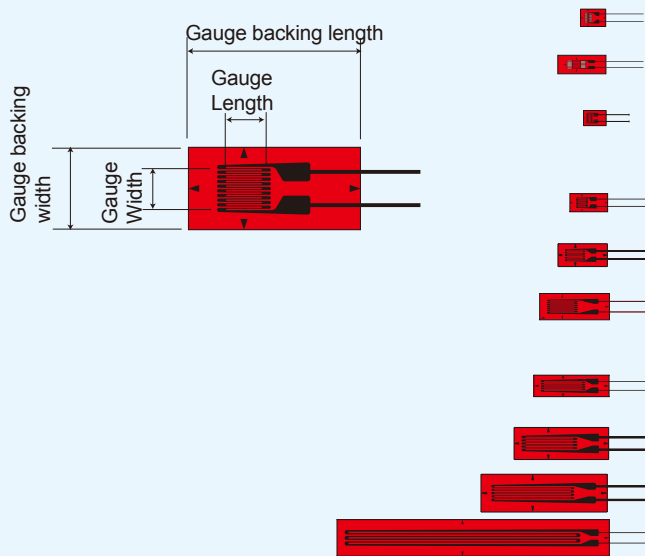











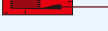

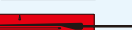

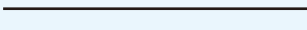
Single element : FLG/FLA/FLK

Each package contains 10 gauges.



FLK type with narrow gauge width

High gauge resistance 350Ω and 1000Ω

	FLG-02	0.2	1.4	3.5	2.5	120
	FLG-1	1	1.1	6.5	2.5	120
	FLA-03	0.3	1.4	3	2	120
	FLA-05	0.5	1.2	5	2.2	120
	FLA-1	1	1.3	5	2.5	120
	FLA-2	2	1.5	6.5	3	120
	FLA-3	3	1.7	8.8	3.5	120
	FLA-3-60	3	1.2	8	3	60
	FLA-5	5	1.5	10	3	120
	FLA-6	6	2.2	12.5	4.3	120
	FLA-10	10	2.5	16.7	5	120
	FLA-30	30	2	36.1	5.1	120
	FLK-1	1	0.7	4.5	1.4	120
	FLK-2	2	0.9	5.5	1.5	120
	FLK-6	6	1.0	11.2	2.2	120
	FLK-10	10	1.6	16.2	3.8	120
	FLA-1-350	1	2	4.6	3	350
	FLA-2-350	2	1.9	6.1	3.5	350
	FLA-3-350	3	3.2	7.2	3	350
	FLA-5-350	5	1.8	9.4	3.8	350
	FLA-6-1000	6	4.6	13.5	7	1000

-196°C Operating temperature range +150°C

Temperature compensation range
+10°C +100°C

Suffix code for temperature compensation materials
-11: Mild steel ■ -17: Stainless steel ■ -23: Aluminium ■

For ordering, the above suffix code should be added to the basic gauge type.

FOIL STRAIN GAUGES

series F

Applicable adhesives

CN	-196 ~ +120°C
P-2	-30 ~ +150°C
EB-2	-60 ~ +150°C

GENERAL USE

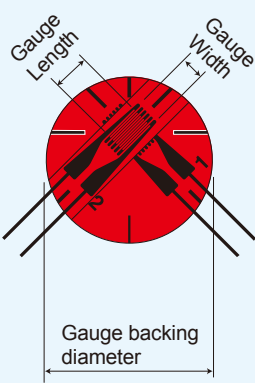
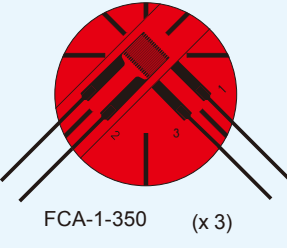
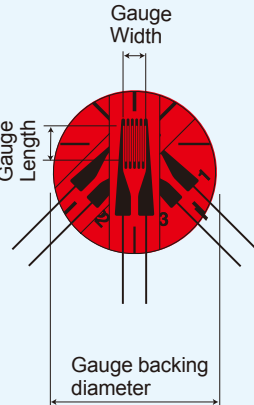
Gauge pattern	Basic type	Gauge size L W	Backing L W	Resistance Ω
				
Each package contains 10 gauges.				
<p>0°/90° 2-element Rosette Stacked: FCA</p> 	FCA-1	1 0.7	ϕ 4.5	120
	FCA-2	2 0.9	ϕ 7	120
	FCA-3	3 1.7	ϕ 11	120
	FCA-5	5 1.9	ϕ 12	120
	FCA-6	6 2.4	ϕ 14	120
	FCA-10	10 2.5	ϕ 17	120
	Each package contains 10 gauges.			
<p>350Ω 0°/90° 2-element Rosette Stacked: FCA</p> 	FCA-1-350	1 1.6	ϕ 8	350
	FCA-2-350	2 1.9	ϕ 9.5	350
	FCA-3-350	3 2	ϕ 10	350
	FCA-5-350	5 1.8	ϕ 10	350
Each package contains 10 gauges.				
<p>0°/45°/90° 3-element Rosette Stacked: FRA</p> 	FRA-1	1 0.7	ϕ 4.5	120
	FRA-2	2 0.9	ϕ 7	120
	FRA-3	3 1.7	ϕ 11	120
	FRA-5	5 1.9	ϕ 12	120
	FRA-6	6 2.4	ϕ 14	120
	FRA-10	10 2.5	ϕ 17	120

FOIL STRAIN GAUGES



series F

-196°C Operating temperature range
 +150°C
 Temperature compensation range
 +10°C ~ +100°C

Suffix code for temperature compensation materials
 -11: Mild steel ■ -17: Stainless steel ■ -23: Aluminium ■
 For ordering, the above suffix code should be added to the basic gauge type.

Applicable adhesives	CN	-196 ~ +120°C
	P-2	-30 ~ +150°C
	EB-2	-60 ~ +150°C

GENERAL USE

Gauge pattern	Basic type	Gauge size		Backing		Resistance Ω
		L	W	L	W	
 						
<p>Example of type number designation</p> <p><u>FLA-5</u> <u>-350</u> <u>-11</u> <u>-3LJB/-3LJBT</u> (2-wire/3-wire)</p> <p>↑ Length in meter and type of integral leadwire(*1) ↑ Self-temperature-compensation number(*2) ↑ Gauge resistance in ohm (Blank for 120Ω) ↑ Basic strain gauge type and gauge length</p> <p>*1 : Not mentioned for gauges without leadwire *2 : The following numbers are available for F series gauges -11: Mild steel (11ppm/°C) -17: Stainless steel, Copper alloy (17ppm/°C) -23: Aluminium (23ppm/°C)</p>						

350Ω 0°/45°/90° 3-element Rosette Stacked: FRA

Each package contains 10 gauges.

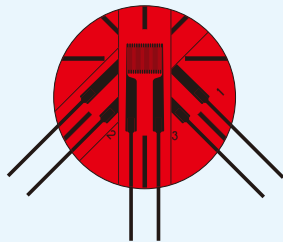

FRA-1-350 (x 3)

FRA-1-350

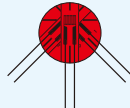

FRA-2-350

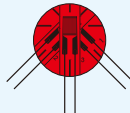



FRA-5-350



FRA-1-350	1	1.6	φ 8	350
FRA-2-350	2	1.9	φ 9.5	350
FRA-3-350	3	2	φ 10	350
FRA-5-350	5	1.8	φ 10	350

SPECIAL USE

Gauge pattern	Basic type	Gauge size		Backing		Resistance Ω
		L	W	L	W	
 						
<p>Option F This code is appended to the basic type for strain gauges with lead-free solder in place of leaded solder. Fatigue life of the strain gauge may become shorter by the lead-free solder.</p> <p>Example of type number designation</p> <p><u>FLT-05A</u> <u>-11</u> <u>-350</u> <u>-F</u> <u>-3LJC</u> <u>-F</u></p> <p>↑ Option F : LEAD-free soldering of leadwire ↑ Length in meter and type of integration leadwire ↑ Option F: LEAD-free soldering of strain gauge ↑ Gauge resistance (Blank for 120Ω) ↑ Self-temperature-compensation number ↑ Basic strain gauge type</p>						

Shearing strain measurement : FLT

Each package contains 10 gauges.

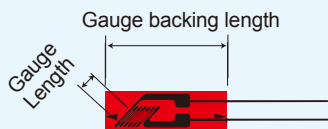

Left 45°
 Right 45°

FLT-05A	0.5	0.66	4	1.3	120
FLT-05B	0.5	0.66	4	1.3	120

Torque measurement : FCT

Each package contains 10 gauges.

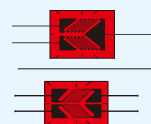
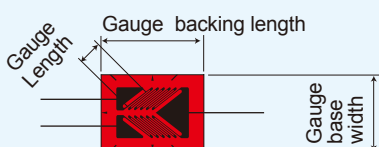

FCT-2	2	1.5	8.7	6.5	120
FCT-2-350	2	1.5	7.6	5.3	350



FOIL STRAIN GAUGES

series F

Suffix code for temperature compensation materials
 -11: Mild steel ■ -17: Stainless steel ■ -23: Aluminium ■
 For ordering, the above suffix code should be added to the basic gauge type.

Applicable adhesives

CN	-196 ~ +120°C
P-2	-30 ~ +150°C
EB-2	-60 ~ +150°C

SPECIAL USE

Option F

This code is appended to the basic type for strain gauges with lead-free solder in place of leaded solder. Fatigue life of the strain gauge may become shorter by the lead-free solder.



Example of type number designation

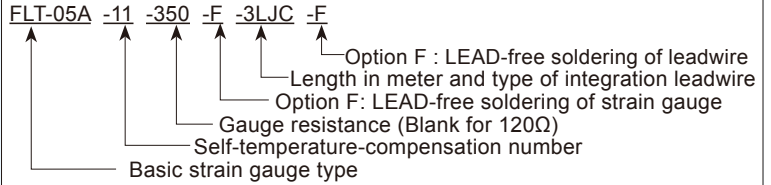

0°/90° 2-element Rosette Plane : FCB

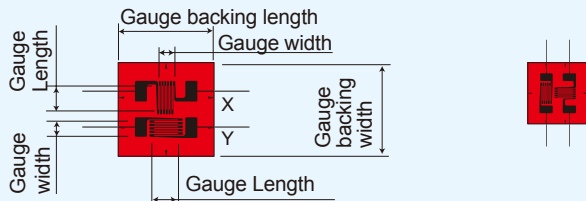

Each package contains 10 gauges.

FCB-2	X and Y axes	2	1.5	8.2	8	120
FCB-6-350	X and Y axes	6	2.0	10	13	350

Residual stress measurement : FR/EUBC/FRS

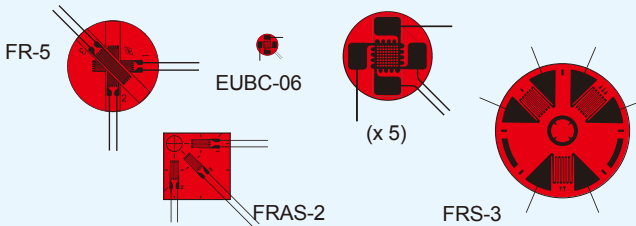

Each package contains 10 gauges.

FR-5		5	1.5	φ 12		120
EUBC-06		0.6	0.7	φ 2.4		120
FRAS-2		2	1.1	9	9	120
FRS-2		1.5	1.3	φ 9.5		120
FRS-3		3	2.6	φ 17.5		120

GLASS, CERAMIC

Gauge pattern

Basic type

Gauge size
L W

Backing
L W

Resist-
ance Ω

Suffix code for temperature compensation materials

-8: Glass, Ceramic ■

For ordering, the above suffix code should be added to the basic gauge type.



Example of type number designation

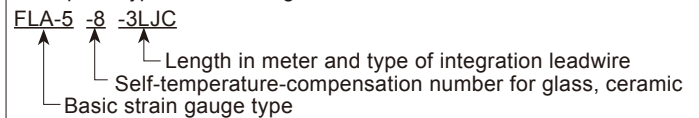

Applicable adhesives

CN	-196 ~ +120°C
P-2	-30 ~ +150°C
EB-2	-60 ~ +150°C

Single element : FLA

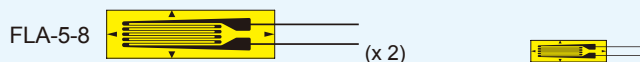

Each package contains 10 gauges.

FLA-2		2	1.5	6.5	3	120
FLA-5		5	1.5	10.0	3	120

0°/90° 2-element stacked Rosette FCA

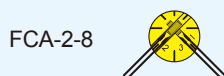

Each package contains 10 gauges.

FCA-2		2	0.9	φ 7		120
FCA-5		5	1.9	φ 12		120

0°/45°/90° 3-element stacked Rosette FRA

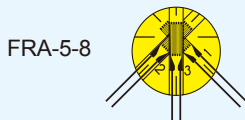

Each package contains 10 gauges.

FRA-2		2	0.9	φ 7		120
FRA-5		5	1.9	φ 12		120

FOIL STRAIN GAUGES

series F

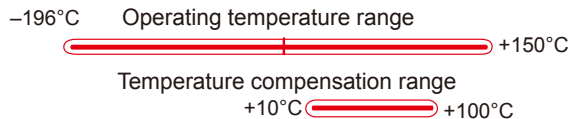

Suffix code for temperature compensation materials
 -11: Mild steel ■ -17: Stainless steel ■ -23: Aluminium ■

Applicable adhesives

CN	-196 ~ +120°C
P-2	-30 ~ +150°C
EB-2	-60 ~ +150°C

For ordering, the above suffix code should be added to the basic gauge type.

STRESS CONCENTRATION MEASUREMENT

Gauge pattern	Basic type	Gauge size		Backing		Resistance Ω
		L	W	L	W	

Option F

This code is appended to the basic type for strain gauges with lead-free solder in place of leaded solder. Fatigue life of the strain gauge may become shorter by the lead-free solder.



Example of type number designation

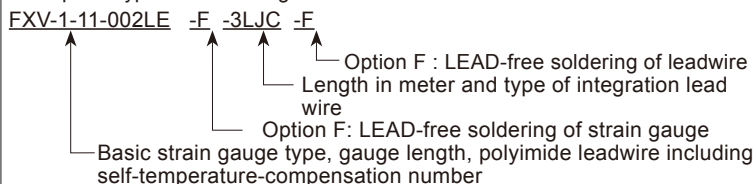

5-element Single-axis : FXV/FYV/FBXV/FBYV

Each package contains 10 gauges.

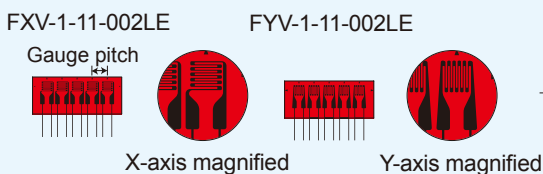

Gauge pitch 2mm	FXV-1-002LE	1	1.3	5	12	120
	FYV-1-002LE	1	1.4	5	12	120

-002LE: Polyimide insulated gauge lead of 2-cm pre-attached

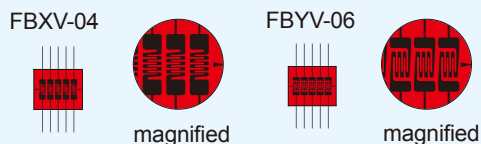

Gauge pitch 1mm	FBXV-04-005LE	0.4	1.3	5.4	7.4	120
	FBYV-06-005LE	0.6	0.8	5.3	7	120

-005LE: Polyimide insulated gauge lead of 5-cm pre-attached

10-element 2 axes : FCV

Each package contains 10 gauges.



Gauge pitch 2mm	FCV-1-005LE	1	1.4	7.5	12	120
--------------------	-------------	---	-----	-----	----	-----

-005LE: Polyimide insulated gauge lead of 5-cm pre-attached

Single element : FBX/FBY/FLX

Each package contains 10 gauges.

Single element cut away from the above Stress Concentration gauge.

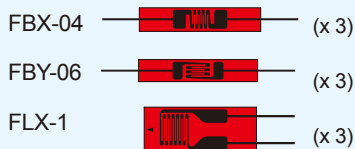

FBX-04-005LE	0.4	1.3	5.4	1	120
FBY-06-005LE	0.6	0.8	5.3	1	120
FLX-1-002LE	1	1.3	5	2	120

-005LE: Polyimide insulated gauge lead of 5-cm pre-attached
 -002LE: Polyimide insulated gauge lead of 2-cm pre-attached

Chain Strain Gauges CCFXX, CCFYX

Each package contains 10 gauges.

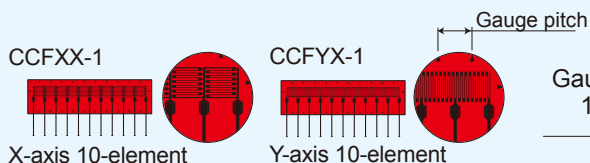





Gauge pitch 1.5mm	CCFXX-1-002LE	1	1.5	16.4	4.5	120
	CCFYX-1-002LE	1	1.5	16.4	4.5	120

-002LE: Polyimide insulated gauge lead of 2-cm pre-attached

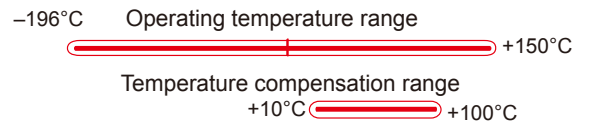
These gauges are specially designed to use Complete correction method for strain and need our Data Logger TDS-540 for the measurement. For details, contact TML.

FOIL STRAIN GAUGES series F



Suffix code for temperature compensation materials
 -11: Mild steel  -17: Stainless steel  -23: Aluminium 
 For ordering, the above suffix code should be added to the basic gauge type.

Applicable adhesives

CN	-196 ~ +120°C
P-2	-30 ~ +150°C
EB-2	-60 ~ +150°C









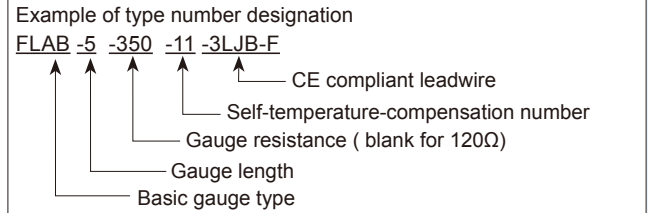
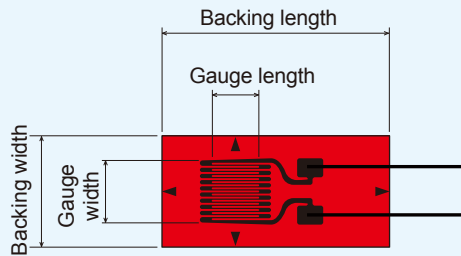













GENERAL USE

Strain gauges compliant to RoHS2 Directive 2011/65/EU are added to the lineup in F series. They are supplied with CE marking as standard specification. Our logo GOBLET, which is an abbreviation of "Gauges Of Brilliant Lifespan and Environmental Thoughtful", is marked on the package of these gauges.



Single element





Gauge pattern	Basic type	Gauge size		Backing		Resistance Ω		
		L	W	L	W			
	FLGB-02	0.2	1.4	3.5	2.5	120		
	FLGB-1	1	1.1	6	2.5	120		
	FLAB-03	0.3	1.4	3	2	120		
	FLAB-05	0.5	1.2	4.3	2.2	120		
	FLAB-1	1	1.3	5	2.5	120		
	FLAB-2	2	1.5	6.5	3	120		
	FLAB-3	3	1.7	7.7	3.5	120		
	FLAB-3-60	3	1.2	7.7	3	60		
	FLAB-5	5	1.5	10	3	120		
	FLAB-6	6	2.2	11	4.3	120		
	FLAB-10	10	2.5	15.4	5	120		
	FLAB-30	30	2	35	5	120		
FLK pattern with narrow gauge width		FLKB-1	1	0.7	4.5	1.4	120	
		FLKB-2	2	0.9	5.5	1.5	120	
		FLKB-6	6	1	11	2.2	120	
		FLKB-10	10	1.6	15	3.8	120	
350 Ω Single element		FLAB-1-350	1	1.6	4.5	3	350	
		FLAB-2-350	2	1.9	6	3.5	350	
		FLAB-3-350	3	1.6	7.2	3	350	
	Gauge resistance 350 Ω		FLAB-5-350	5	1.8	9.4	3.8	350
			FLAB-6-350	6	2.6	10.8	4.5	350
			FLAB-10-350	10	3	16	5	350
		FLAB-6-1000	6	4.6	11	7	1000	

Each package contains 10 gauges.

FOIL STRAIN GAUGES series F

-196°C Operating temperature range  +150°C

Temperature compensation range  +100°C

Suffix code for temperature compensation materials
 -11: Mild steel  -17: Stainless steel  -23: Aluminium 

Applicable adhesives

CN	-196 ~ +120°C
P-2	-30 ~ +150°C
EB-2	-60 ~ +150°C

For ordering, the above suffix code should be added to the basic gauge type.

GENERAL USE

Gauge pattern	Basic type	Gauge size		Backing		Resistance Ω
		L	W	L	W	

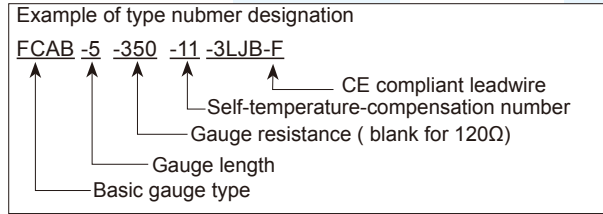

Each package contains 10 gauges.

0°/90° 2-element rosette stacked

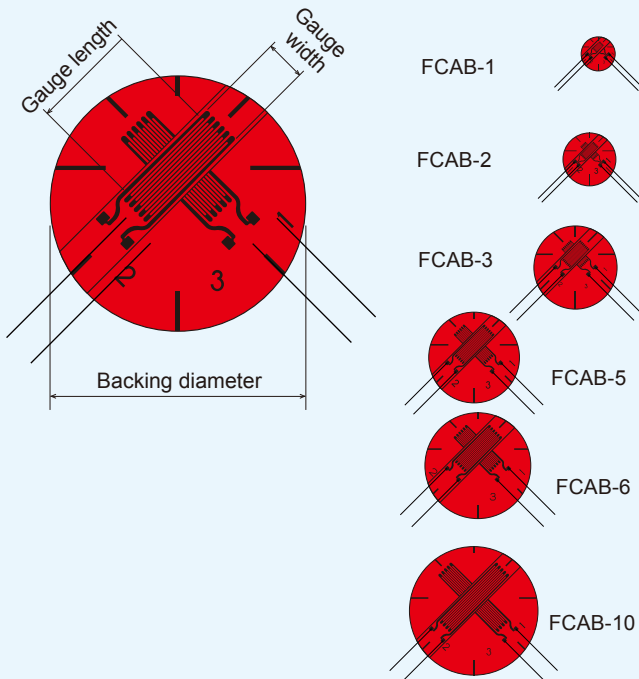

FCAB-1	1	0.7	φ 4.5	120
FCAB-2	2	0.9	φ 7	120
FCAB-3	3	1.7	φ 11	120
FCAB-5	5	1.9	φ 12	120
FCAB-6	6	2.4	φ 14	120
FCAB-10	10	2.5	φ 17	120

350Ω 0°/90° 2-element rosette stacked

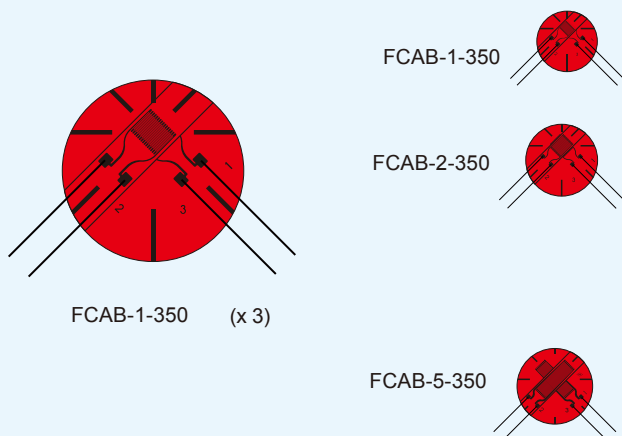

Each package contains 10 gauges.

FCAB-1-350	1	1.6	φ 8	350
FCAB-2-350	2	1.9	φ 9.5	350
FCAB-3-350	3	2	φ 10	350
FCAB-5-350	5	1.8	φ 10	350

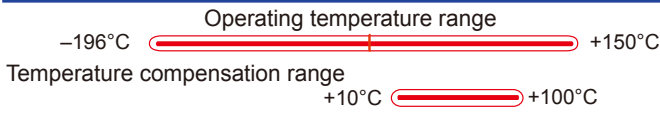

FOIL STRAIN GAUGES

F Series



Suffix code for temperature compensation materials
 -11: Mild steel ■ -17: Stainless steel ■ -23: Aluminium ■
 For ordering, the above suffix code should be added to the basic gauge type.

Applicable adhesives

CN	-196 ~ +120°C
P-2	-30 ~ +150°C
EB-2	-60 ~ +150°C

GENERAL USE

Gauge pattern	Basic type	Gauge size		Backing		Resistance Ω
		L	W	L	W	
<p>0°/45°/90° 3-element rosette stacked</p>						
<p>Example of type number designation</p> <p>FRAB -5 -350 -11 -3LJB-F</p> <p> ↑ Basic gauge type ↑ Gauge length ↑ Gauge resistance (blank for 120Ω) ↑ Self-temperature-compensation number ↑ CE compliant leadwire </p>						
<p>Each package contains 10 gauges.</p>						
	FRAB-1	1	0.7	ϕ 4.5		120
	FRAB-2	2	0.9	ϕ 7		120
	FRAB-3	3	1.7	ϕ 11		120
	FRAB-5	5	1.9	ϕ 12		120
	FRAB-6	6	2.4	ϕ 14		120
	FRAB-10	10	2.5	ϕ 17		120
<p>Each package contains 10 gauges.</p>						
	FRAB-1-350	1	1.6	ϕ 8		350
	FRAB-2-350	2	1.9	ϕ 9.5		350
	FRAB-3-350	3	2	ϕ 10		350
	FRAB-5-350	5	1.8	ϕ 10		350

FOIL STRAIN GAUGES series F



-196°C Operating temperature range +150°C

Temperature compensation range
+10°C +100°C

Suffix code for temperature compensation materials
-8: Glass, Ceramic



Applicable adhesives

CN	-196 ~ +120°C
P-2	-30 ~ +150°C
EB-2	-60 ~ +150°C

For ordering, the above suffix code should be added to the basic gauge type.

GLASS, CERAMIC USE

Gauge pattern	Basic type	Gauge size		Backing		Resistance Ω	
		L	W	L	W		
<p>Single element FLAB-5-8 (x 2)</p>	<p>Example of type number designation</p> <p>FRAB -5 -8 -3LJB-F</p> <ul style="list-style-type: none"> FRAB: Basic gauge type -5: Gauge length -8: Self-temperature-compensation number -3LJB-F: CE compliant leadwire 	Each package contains 10 gauges.					
<p>0°/90° 2-element rosette stacked FCAB-5-8 (x 2)</p>		FLAB-2-8	2	1.5	6.5	3	120
		FLAB-5-8	5	1.5	10	3	120
<p>0°/45°/90° 3-element rosette stacked FRAB-5-8 (x 2)</p>		Each package contains 10 gauges.					
		FCAB-2-8	2	0.9	φ 7	120	
		FCAB-5-8	5	1.9	φ 12	120	
		Each package contains 10 gauges.					
		FRAB-2-8	2	0.9	φ 7	120	
		FRAB-5-8	5	1.9	φ 12	120	

Dedicated leadwires recommendable for strain gauge F series

Application	Leadwires	Operating temperature (°C)	Leadwire code exemplified
General use (temperature unchanged during measurement)	Paralleled vinyl LJB / LJB-F Paralleled vinyl LJC / LJC-F	-20 ~ +80	FLA-5-11-3LJB FLA-5-11-3LJC
General use	3-wire paralleled vinyl LJBT / LJBT-F 3-wire paralleled vinyl LJCT / LJCT-F	-20 ~ +80	FLA-5-11-3LJBT FLA-5-11-3LJCT
Mid-high temperature	3-wire paralleled vinyl LXT / LXT-F	-20 ~ +150	FLA-5-11-3LXT
Temperature integration	3-wire paralleled vinyl TLJBT / TLJBT-F	-20 ~ +80	FLA-5T-11-3TLJBT
1-Gauge 4-Wire measurement	Polypropyrene 4-wire paralleled LQM / LQM-F	-20 ~ +100	FLA-5-11-3LQM (modular plug attached)

Recommendable for GOBLET strain gauges



Application	Leadwires	Operating temperature (°C)	Leadwire code exemplified
General use (temperature unchanged during measurement)	Paralleled vinyl LJB-F Paralleled vinyl LJC-F	-20 ~ +80	FLAB-5-11-3LJB-F FLAB-5-11-3LJC-F
General use	3-wire paralleled vinyl LJBT-F 3-wire paralleled vinyl LJCT-F	-20 ~ +80	FLAB-5-11-3LJBT-F FLAB-5-11-3LJCT-F
Mid-high temperature	3-wire paralleled vinyl LXT-F	-20 ~ +150	FLAB-5-11-3LXT-F
Temperature integration	3-wire paralleled vinyl TLJBT-F	-20 ~ +80	FLAB-5T-11-3TLJBT-F
1-Gauge 4-Wire measurement	Polypropyrene 4-wire paralleled LQM-F	-20 ~ +100	FLAB-5-11-3LQM-F (modular plug attached)

NB: For use with CE compliant GOBLET strain gauges, specify leadwire with option -F having lead-free solder on order.

WATERPROOF STRAIN GAUGES series WF

Operating temperature range
0°C  +80°C



Temperature compensation range
+10°C  +80°C

Suffix code for temperature compensation materials
-11: Mild steel  -17: Stainless steel  -23: Aluminium 

Applicable adhesives	CN	0 ~ +80°C
	P-2	0 ~ +80°C
	EB-2	0 ~ +80°C

For ordering, the above suffix code should be added to the basic gauge type.

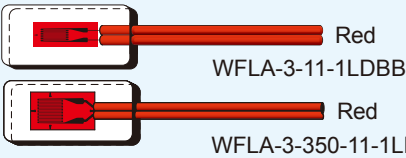
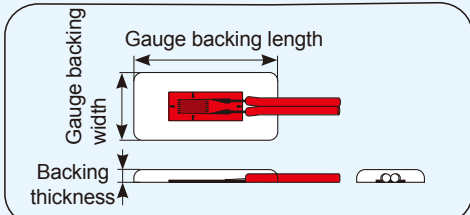
WATERPROOF STRAIN GAUGES

Gauge pattern	Basic type	Gauge size		Backing		Resistance Ω
		L	W	L	W	
<p>These gauges eliminate the need for moisture-proofing coating, which is sometimes troublesome in a field test. They have an integral vinyl leadwire, and whole area of the strain gauges and the leadwire junction are coated with epoxy resin. The coating is transparent and flexible, so the positioning and bonding works are very easy. By merely bonding the gauges with CN or P-2 adhesive, outdoor or underwater measurement for a short-term becomes possible. These gauges are also effective in omitting primary coating in case of applying a multi-layer coating.</p> <p>Single element : WFLA 0.08mm² integral vinyl leadwire Total leadwire resistance per meter : 0.44Ω 2-wire system</p>  <p>WFLA-3-11-1LDBB WFLA-3-350-11-1LDBB</p>  <p>3-wire system WFLA-6-11-3LDBTB Red stripe (independent)</p> <p>0°/90° 2-element stacked Rosette WFC A 3-wire system Red stripe (1st axis) Black stripe (2nd axis) WFC A-6-11-3LDBTB</p> <p>0°/45°/90° 3-element stacked Rosette WFR A 2-wire system Red (1st axis) Green (3rd axis) White (2nd axis) WFR A-3-11-1LDBB</p> <p>3-wire system Red stripe (1st axis) Blue stripe (3rd axis) Black stripe (2nd axis) WFR A-6-11-3LDBTB</p>	 <p>Example of type number designation WFLA -3 -350 -11 -3LDBB ↑ ↑ ↑ ↑ ↑ Basic gauge type Gauge length Gauge resistance (blank for 120Ω) Self-temperature-compensation number Length in meter and the specified integral leadwire</p> <p>2-wire system Single element WFLA-3 _ _LDBB WFLA-3-350 _ filled with WFLA-6 length</p> <p>0°/90° 2-element Rosette Stacked WFC A-3 _ _LDBB WFC A-6 length</p> <p>0°/45°/90° 3-element Rosette Stacked WFR A-3 _LDBB WFR A-6 length</p> <p>3-wire system Single element WFLA-3 _ _LDBTB WFLA-6 length</p> <p>0°/90° 2-element Stacked WFC A-3 _ _LDBTB WFC A-6 length</p> <p>0°/45°/90° 3-element Rosette Stacked WFR A-3 _LDBTB WFR A-6 length</p>					
Minimum order is 10 gauges or more.						
Minimum order is 10 gauges or more.						

HIGH TEMPERATURE series QF STRAIN GAUGES

Operating temperature range



Temperature compensation range



Suffix code for temperature compensation materials

-11: Mild steel -17: Stainless steel -23: Aluminium -28: Magnesium

Applicable adhesives

CN	-20 ~ +120°C
NP-50B	-20 ~ +200°C
C-1/EB-2	-20 ~ +200°C

Backing colors are all the same with different materials For ordering, the above suffix code should be added to the basic gauge type.

GENERAL PURPOSE/SHEARING STRESS MEASUREMENT

Gauge pattern	Basic type	Gauge size		Backing			Resistance Ω
		L	W	L	W	T	
<p>These are foil strain gauges having a polyimide resin backing, which exhibits excellent performance in high temperature up to 200°C. Stress concentration measurement gauges and shear stress measurement gauges are also available in this series.</p> <p style="text-align: center;">CE</p>							
<p>Single element : QFLG/QFLA/QFLK</p> <p style="text-align: right;">Each package contains 10 gauges.</p>							
<p>General purpose</p> <p>FLK type with narrow gauge base</p> <p>for Magnesium</p> <p>High gauge resistance</p>	QFLG-02-11	0.2	1.4	3.5	2.5	120	
	QFLA-1-11	1	1.3	5	2.5	120	
	QFLA-2-11	2	1.5	6.5	3	120	
	QFLA-3-11	3	1.7	8.8	3.5	120	
	QFLA-5-11	5	1.5	10	3	120	
	QFLA-6-11	6	2.2	12.5	4.3	120	
	QFLK-1-11	1	0.7	4.5	1.4	120	
	QFLK-2-11	2	0.9	5.5	1.5	120	
	QFLK-2-28	2	0.9	5.5	1.5	120	
	QFLA-1-350-11	1	2	5	4	350	
QFLA-2-350-11	2	1.9	6.1	3.5	350		
QFLA-3-350-11	3	3.2	8.5	5	350		
QFLA-6-350-11	6	2.6	12.5	4.5	350		
QFLA-6-1000-11	6	4.6	13.5	7	1000		
<p>0°/90° 2-element plane Rosette QFCA</p> <p style="text-align: right;">Each package contains 10 gauges.</p>							
<p>QFCA-1-11 Y X QFCB-2-11</p>	QFCA-1-11	1	1.3	7.2	7.2	120	
	QFCA-3-11	3	1.7	11	11	120	
	QFCB-2-11	X and Y axes 2	1.5	8.2	8	120	
<p>0°/45°/90° 3-element plane Rosette QFRA</p> <p style="text-align: right;">Each package contains 10 gauges.</p>							
<p>QFRA-1-11</p>	QFRA-1-11	1	1.3	7.2	7.2	120	
	QFRA-3-11	3	1.7	11	11	120	
<p>Single element Shearing strain measurement</p> <p style="text-align: right;">Each package contains 10 gauges.</p>							
	QFLT-05A-11-002LE	0.5	0.66	4	1.3	120	
	QFLT-05B-11-002LE	0.5	0.66	4	1.3	120	
	QFLT-1A-11-002LE	1.2	1.1	5.7	2	120	
	QFLT-1-350A-11-002LE	1	1.1	5.7	2	350	
	QFLT-1B-11-002LE	1.2	1.1	5.7	2	120	
	QFLT-1-350B-11-002LE	1	1.1	5.7	2	350	
<p>N.B. -002LE: Polyimide leadwire of 2-cm pre-attached</p>							

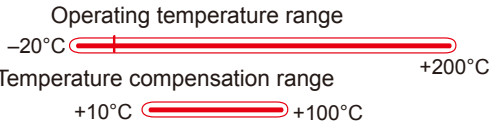

HIGH TEMPERATURE STRAIN GAUGES series QF

Suffix code for temperature compensation materials
 -11: Mild steel -17: Stainless steel -23: Aluminium

Applicable adhesives	CN	-20 ~ +120°C
	NP-50B	-20 ~ +200°C
	C-1/EB-2	-20 ~ +200°C

Backing colors are all the same with different materials For ordering, the above suffix code should be added to the basic gauge type.

STRESS CONCENTRATION MEASUREMENT

Gauge pattern	Basic type	Gauge size		Backing			Resist- ance Ω
		L	W	L	W	T	
CE							
5-element single-axis : QFXV/QFYV/QFBXV/QFBYV		Each package contains 10 gauges.					
QFXV-1-11-002LE Gauge pitch 2mm X-axis magnified	QFYV-1-11-002LE	1	1.3	5	12	120	120
	QFYV-1-11-002LE						
N.B. -002LE: Polyimide insulated gauge lead of 2-cm pre-attached							
QFBXV-04 Gauge pitch 1mm magnified	QFBYV-06	0.4	1.3	5.4	7.4	120	120
	QFBYV-06						
N.B. -005LE: Polyimide leadwire of 5-cm pre-attached							
Single element : QFBX/QFBY/QFLX		Each package contains 10 gauges.					
Single element cut away from the above Stress Concentration gauge.							
QFBX-04		0.4	1.3	5.4	1	120	120
QFBY-06		0.6	0.8	5.3	1	120	120
QFLX-1		1	1.3	5	2	120	120
N.B. -005LE: Polyimide leadwire of 5-cm pre-attached N.B. -002LE: Polyimide leadwire of 2-cm pre-attached							
Torque measurement : QFCT		Each package contains 10 gauges.					
QFCT-2-11		2	1.5	8.7	6.5	120	120
QFCT-2-350-11		2	1.7	7.6	5.3	350	350

Recommendable integral leadwire for QF series

Application	Leadwires	Operating temperature (°C)	Leadwire code exemplified
General use (temperature unchanged during measurement)	Paralleled vinyl LJC-F	-20~ +80	QFLA-1-11-3LJC-F
General use	3-wire paralleled vinyl LJCT-F	-20~ +80	QFLA-1-11-3LJCT-F
Waterproof	3-wire twisted cross-linked vinyl LJRTA	-20~ +100	QFLA-1-11-3LJRTA-F
High temperature	3-wire twisted fluorinated resin (FEP) 6FA_LT-F (No Tetra-Etch required for surface preparation) 3-wire twisted fluorinated resin (FEP) 6FB_LT-F	-269~ +200	QFLA-1-11-6FA3LT-F QFLA-1-11-6FB3LT-F

Example of type number designation.

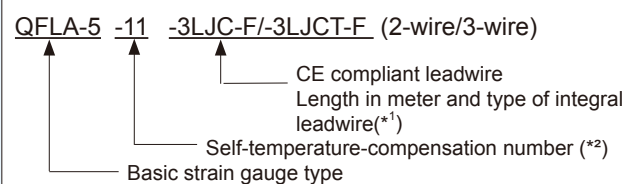

*1: Not mentioned for gauges without integral leadwire.
 *2: QF-series gauges are available for self-temperature-compensation with -11 (Mild steel of 11ppm/°C)
 For the following numbers, contact TML or your local representative.
 -17: Stainless steel, Copper alloy (17ppm/°C)
 -23: Aluminium (23ppm/°C)

HIGH TEMPERATURE STRAIN GAUGES series ZF

Operating temperature range



Temperature compensation range



Suffix code for temperature compensation materials
 -11: Mild steel -17: Stainless steel -23: Aluminium



Applicable adhesives

NP-50B	-20 ~ +300°C
C-1/EB-2	-20 ~ +200°C
CN	-20 ~ +120°C

Backing colors are all the same with different materials For ordering, the above suffix code should be added to the basic gauge type.

HIGH TEMPERATURE USE

Gauge pattern	Basic type	Gauge size		Backing		Resistance Ω
		L	W	L	W	

These strain gauges are designed for measurement in high temperature up to 300°C. It utilizes specially designed Ni-Cr alloy foil for the grid and polyimide resin for the gauge backing. Owing to the construction, the strain gauges are successfully used for measurement in high temperature.



Each package contains 10 gauges.

ZFLK-2-11	2	0.5	5.4	1.4	120
ZFLA-1-11	1	1.8	7	3	120
ZFLA-3-11	3	1.8	10.5	3.5	120
ZFLA-6-11	6	2.5	15.5	4.5	120
ZFLA-3-60-11	3	0.7	7.7	2.6	60
ZFLA-1-350-11	1	1.7	6.6	3.2	350
ZFLA-3-350-11	3	3.2	10.2	5.2	350
ZFLA-6-350-11	6	2.8	16	5.3	350

Single element : ZFLA

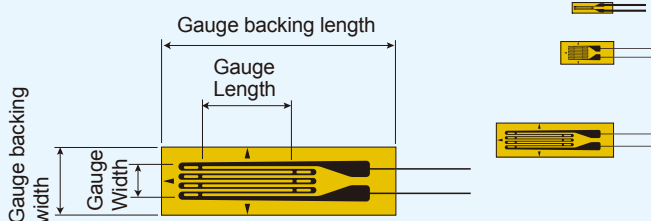

0°/90° 2-element Rosette

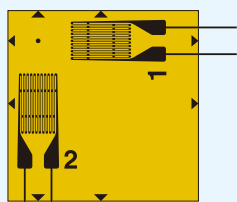

ZFCA-1-350-11 (x 3)

Plane : ZFCA
Stacked : ZFCAL

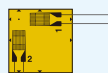

ZFCA-1-350-11



ZFCAL-1-11

Each package contains 10 gauges.

Plane type					
ZFCA-1-350-11	1	1.7	8.5	8.5	350
ZFCA-3-350-11	3	1.4	10.5	10.5	350

Stacked type					
ZFCAL-1-11	1	1.1	φ 5.4		120

0°/45°/90° 3-element Rosette

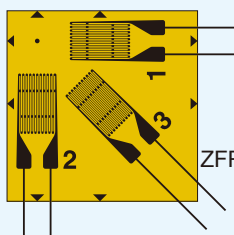

ZFRA-1-350-11 (x 3)

Plane : ZFRA
Stacked : ZFRAL

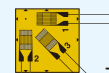

ZFRA-1-350-11



ZFRAL-1-11

Each package contains 10 gauges.

Plane type					
ZFRA-1-350-11	1	1.7	8.5	8.5	350
ZFRA-3-350-11	3	1.4	10.5	10.5	350

Stacked type					
ZFRAL-1-11	1	1.1	φ 5.4		120

Recommendable integral leadwire for ZF series

Application	Leadwires	Operating temperature (°C)	Leadwire code exemplified
General use (temperature unchanged during measurement)	Paralleled vinyl LJC-F	-20~ +80	ZFLA-3-350-11-3LJC-F
General use	3-wire paralleled vinyl LJCT-F	-20~ +80	ZFLA-3-350-11-3LJCT-F
Waterproof	3-wire twisted cross-linked vinyl LJRTA-F	-20~ +100	ZFLA-3-350-11-3LJRTA
High temperature	3-wire twisted FEP 6FA_LT-F (No Tetra-Etch required for surface) 3-wire twisted FEP 6FB_LT-F	-269~ +200	ZFLA-3-350-11-6FA3LT-F ZFLA-3-350-11-6FB3LT-F
	3-wire twisted PTFE 4FA_LT-F 3-wire twisted PTFE 4FB_LT-F	-269~ +260 For short term use, +300°C is available.	ZFLA-3-350-11-4FA3LT-F ZFLA-3-350-11-4FB3LT-F

Example of type number designation.

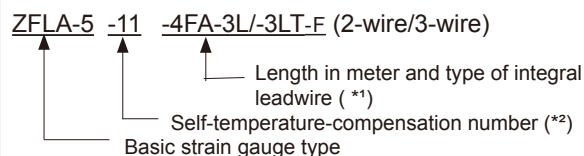

*1: Not mentioned for gauges without integral leadwire.

*2: ZF-series gauges are available for self-temperature-compensation with -11 (Mild steel of 11ppm/°C)

For the following numbers, contact TML.
 -17: Stainless steel, Copper alloy (17ppm/°C)
 -23: Aluminium (23ppm/°C)

HIGH TEMPERATURE series EF STRAIN GAUGES



Suffix code for temperature compensation materials
 -11: Mild steel



Applicable adhesives

CN	-196 ~ +120°C
EB-2	-60 ~ +200°C
C-1	-196 ~ +200°C
NP-50B	-20 ~ +300°C

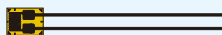
HIGH TEMPERATURE USE, MINIATURE

Gauge pattern	Basic type	Gauge size L W	Backing L W	Resist- ance Ω
<p>These gauges have a small grid pattern required for measurement of printed circuit boards and surface mounted devices, which are getting smaller and smaller. The backing of the gauges is made of polyimide resin. The maximum operating temperature is +300°C for single element gauges and +200°C for two and three elements gauges. The lowest operating temperature is -196°C for both gauges.</p> <p>Single element</p> <p>Operating temperature range: -196°C ~ +300°C Temperature compensation range: +10°C ~ +150°C</p> <p> EFLK-02-11 (x3) Single element</p> <p> EFLX-02-11 (x3)</p>	CE	Each package contains 10 gauges.		
<p>0°/90° 2-element Rosette 0°/45°/90° 3-element Rosette</p> <p>Operating temperature range: -196°C ~ +200°C Temperature compensation range: 0°C ~ +150°C</p> <p> EFRA-05-11 (x3)</p> <p>0°/90° 2-element Stacked Rosette</p> <p>0°/45°/90° 3-element Stacked Rosette</p>		Stacked type		
	EFLK-02-11	0.2 0.8	1.6 1.2	120
	EFLX-02-11	0.2 0.8	1.8 1.2	120
	EFCA-05-11-002LE	0.2 0.8	φ 3.8 1.2	120
	EFRA-05-11-002LE	0.2 0.8	φ 3.8 1.2	120

N.B. -002LE: Polyimide leadwire of 2-cm pre-attached

HIGH & LOW TEMPERATURE STRAIN GAUGES series CEF

Suffix code for temperature compensation materials
 -11: Mild steel -17: Stainless steel -23: Aluminium

Backing colors are all the same with different materials. For ordering, the above suffix code should be added to the basic gauge type.

Operating temperature range: -269°C ~ +200°C
 Temperature compensation range approximately: -196°C ~ +80°C

Applicable adhesives

EA-2A	-269 ~ +50°C
CN	-196 ~ +120°C
C-1	-269 ~ +200°C

HIGH & LOW TEMPERATURE USE

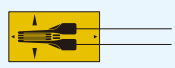
Gauge pattern	Basic type	Gauge size L W	Backing L W	Resist- ance Ω
<p>These are strain gauges utilizing polyimide resin for the gauge backing and special alloy foil for the grid. It features a wide range of operating temperature from cryogenic temperature to +200°C. This series is available only in single axis configuration with gauge length of 1,3 and 6mm.</p> <p>Single element</p> <p> CEFLA-1 (x3)</p>	M metal C ceramic	L : length W : width (Unit:mm)	Each package contains 10 gauges.	
		CEFLA-1	1 0.5	4 2.2
	CEFLA-3	3 0.6	6.9 2.8	120
	CEFLA-6	6 1	10.6 3.1	120

Recommendable integral leadwire for CEF series

Application	Leadwires	Operating temperature (°C)	Leadwire code exemplified
High temperature	3-wire twisted FEP 6FA_LT-F (No Tetra-Etch required for surface) 3-wire twisted FEP 6FB_LT-F	-269 ~ +200	CEFLA-1-11-6FA3LT-F CEFLA-1-11-6FB3LT-F
	3-wire twisted PTFE 4FA_LT-F 3-wire twisted PTFE 4FB_LT-F	-269 ~ +260	CEFLA-1-11-4FA3LT-F CEFLA-1-11-4FB3LT-F

Cryogenic temperature series CF STRAIN GAUGES

Operating temperature range



Temperature compensation range approximately



Suffix code for temperature compensation materials

-11: Mild steel ■ -17: Stainless steel ■ -23: Aluminium ■

For ordering, the above suffix code should be added to the basic gauge type.

Applicable adhesives

EA-2A	-269 ~ +50°C
CN	-196 ~ +80°C
C-1	-269 ~ +80°C

CRYOGENIC TEMPERATURE USE

Gauge pattern	Basic type	Gauge size		Backing		Resistance Ω
		L	W	L	W	

These are foil strain gauges with epoxy backing designed for measurement under cryogenic conditions. They are available in single element, rectangular 2-element and rectangular 3-element configurations with 350Ω resistance. The specially selected and heat treated grid of the gauges shows very small zero shift under cryogenic temperature compared to conventional strain gauges.

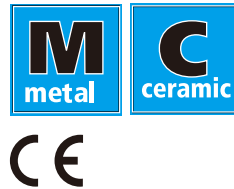

Each package contains 10 gauges.

Single element : CFLA

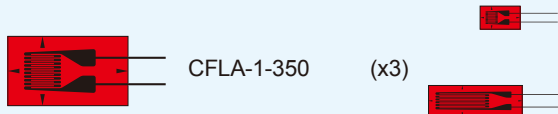

CFLA-1-350	1	1.6	5.4	3.2	350
CFLA-3-350	3	1.7	8.8	3.5	350
CFLA-6-350	6	2.2	12.5	4.3	350

0°/90° 2-element plane Rosette CFCA

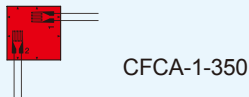

Each package contains 10 gauges.

CFCA-1-350	1	1.3	7.2	7.2	350
CFCA-3-350	3	1.7	11	11	350

0°/45°/90° 3-element plane Rosette CFRA

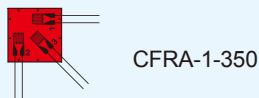

Each package contains 10 gauges.

CFRA-1-350	1	1.3	7.2	7.2	350
CFRA-3-350	3	1.7	11	11	350

Recommendable integral leadwire for CF series

Application	Leadwires	Operating temperature (°C)	Leadwire code exemplified
High temperature	3-wire twisted FEP 6FA_LT-F (No Tetra-Etch required for surface)	-269~ +200	CFLA-1-350-11-6FA3LT-F
	3-wire twisted FEP 6FB_LT-F		CFLA-1-350-11-6FB3LT-F
	3-wire twisted PTFE 4FA_LT-F	-269~ +260	CFLA-1-350-11-4FA3LT-F
	3-wire twisted PTFE 4FB_LT-F		CFLA-1-350-11-4FB3LT-F

Strain measurement in High- and Low-temperature environments

In situations where heating or cooling occurs, as in engines, turbines, nuclear reactors, chemical plants, etc., the mechanical and thermal stresses in the structural materials are measured. Strain measurement in high- or low-temperature environments differs from measurement

in normal temperature (room temperature up to +80°C) in that a problem of thermal output can no longer be ignored, and the key factor is technique used to eliminate or compensate for this thermal output.

Actual strain measurement at high and low temperatures

Material combination chart

Test temperature	High-temperature atmosphere to 300°C	High-temperature atmosphere to 800°C	Cryogenic temperature atmosphere to -269°C
Strain Gauge	ZF series	AWHU (Weldable type)	CF series
Bonding adhesive	NP-50B	Resistance welding	EA-2A, C-1
Connecting terminals	Not used	-	TPF
Leadwire	PTFE-insulated	MI cable	FEP-insulated
Coating materials	TSE3976-B	-	K-1

PTFE : Polytetrafluoroethylene 4F
FEP : Tetrafluoroethylene-hexafluoropropylene copolymer

Wire connection

At temperature above 200°C, ordinary adhesive-bonded connecting terminals cannot be used. Connect gauge leads and leadwires directly using high-temperature solder. In this case, the best method is to use thin stainless steel plates to be welded to a test specimen to secure the leadwire. The same installation method can also be used in low temperature environments, and connecting terminals can also be used as a relay.



Strain measurement in High- and Low-temperature environments

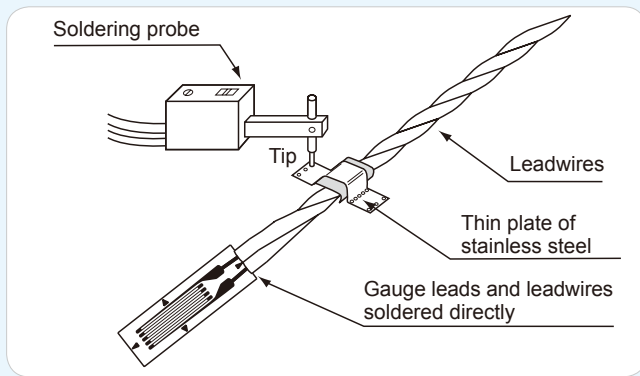

Coating

Materials that are flexible in normal temperature become rigid and brittle in very low temperature, and care should be taken in the thickness of such coatings. K-1 is a coating with excellent hardness and peel strength in low temperature. However, if the coating is applied thicker than necessary, it tends to constrain the section of the test specimen on which the strain gauge is installed, so that accurate measurements cannot be performed. Note that this constraint effect is particularly pronounced when the test specimen is a thin plate.

Curing

To eliminate characteristic fluctuations resulting from repeated temperature cycles, strain gauge and adhesive must be stabilized. Exposing an adhesive that hardens at room temperature to a temperature slightly higher than the test temperature stabilizes the strain gauge and adhesive, thereby improving the reproducibility of the thermal output. For mechanical structures, perform repeated break-in trial runs prior to strain measurement to subject the strain gauge to the temperature and other loads.

Measurement correction and causes of errors

Effects of leadwire temperature

With quarter bridge 2-wire system, changes in leadwire temperature cause changes in the leadwire resistance which in turn generate thermal output. The following equation is to compensate for such thermal output.

$$\epsilon = \frac{r \times L \times \alpha \times \Delta T}{K \times (R + r \times L)}$$

where
 K : Indicated gauge factor
 R : Strain gauge resistance (Ω)
 r : Total resistance per meter of leadwire (Ω/m)
 L : Leadwire length (m)
 ϵ : Leadwire thermal output
 α : Thermal coefficient of resistance of leadwire
 ΔT : Leadwire temperature change ($^{\circ}C$)

The leadwire temperature has no effect on thermal output for quarter bridge measurement with 3-wire system.

Thermal output (Apparent strain with temperature)

If there is temperature change in the strain gauge installed on the test specimen, thermal output will be generated even when there is no strain caused by external force. As a result, if external force is applied along with a change in temperature, the thermal output must be subtracted from the indicated value on the measuring device as shown in the following equation.

$$\epsilon_c(\Delta T) = \epsilon(\Delta T) - \epsilon_{app}(\Delta T)$$

where ΔT : Temperature change at the strain gauge
 $\epsilon_c(\Delta T)$: Value minus thermal output (corrected value)
 $\epsilon(\Delta T)$: Indicated value on strainmeter
 $\epsilon_{app}(\Delta T)$: Thermal output with temperature change

The strain gauge thermal output is shown on the data sheet supplied with the strain gauge in the form of a graph and as a quadratic equation (as a variable of the temperature). This thermal output is the value with the strain gauge installed on the test specimen given on the data sheet. This data is also

formulated based on the standard temperature of $20^{\circ}C$ and a gauge factor of 2.00. To check the thermal output, read the value from the graph or substitute the temperature into the quadratic equation.

Gauge factor change with temperature

Because the gauge factor of a strain gauge also changes with temperature, the gauge factor should be corrected when this change is large. The gauge factor change with temperature is given in the data sheet supplied with the strain gauge in the form of a graph and as a temperature coefficient per $10^{\circ}C$. The gauge factor shown on the strain gauge package is a reference value at room temperature.

Use Equation K_T as below to obtain a gauge factor with temperature change using the indicated gauge factor and the temperature coefficient.

$$\text{Equation } K_T = K \times \{ 1 + C_k \times (t - 20) / 10 \}$$

Where K_T : Gauge factor at $T^{\circ}C$
 K : Gauge factor at room temperature
 C_k : Gauge factor temperature coefficient ($\%/10^{\circ}C$)
 T : Strain gauge temperature ($^{\circ}C$)

Also, in case measurement at $T^{\circ}C$ is performed using normal temperature gauge factor, Equation ϵ_G corrects the indicated value.

$$\text{Equation } \epsilon_G = \frac{K}{K_T} \times \epsilon_T$$

ϵ_G : Strain following correction of the gauge factor for temperature
 ϵ_T : Indicated strain for $T^{\circ}C$

If strain is measured when external force is applied at the same time as a temperature change, perform thermal output and gauge factor corrections described above. Use the following equation to correct the indicated strain on the measuring device and obtain the strain due to the external force.

$$\text{From Equations } \epsilon_c(\Delta T) \text{ and } \epsilon_G, \text{ Equation } \epsilon(\Delta T) = \{ \epsilon_i(\Delta T) - \epsilon_{app}(\Delta T) \} \times \frac{K}{K_T}$$

- Where ΔT : Temperature change experienced by the strain gauge
 $\epsilon(\Delta T)$: Strain due to external force
 $\epsilon_i(\Delta T)$: Indicated strain on the measuring device
 $\epsilon_{app}(\Delta T)$: Thermal output due to the temperature change
 K : Gauge factor at room temperature
 K_T : Gauge factor at $T^{\circ}C$

STRAIN GAUGE TEST DATA

GUAGE TYPE	: FLA-3-11	TESTED ON	: SS 400
LOT NO.	: A502515	COEFFICIENT OF THERMAL EXPANSION	: $11.8 \times 10^{-6}/^{\circ}C$
GUAGE FACTOR	: 2.14 $\pm 1\%$	TEMPERATURE COEFFICIENT OF G.F.	: $+0.1 \pm 0.05 \%/10^{\circ}C$
ADHESIVE	: P-2	DATA NO.	: A0312

Thermal output (ϵ_{app} : APPARENT STRAIN)
 $\epsilon_{app} = -2.94 \times 10^{-1} + 2.32 \times 10^{-4} - 4.60 \times 10^{-2} \times T^2 + 1.67 \times 10^{-4} \times T^3 + 5.00 \times 10^{-7} \times T^4$ ($\mu m/m$)
 Tolerance : ± 0.85 [$\mu m/m$]/ $^{\circ}C$], T : Temperature

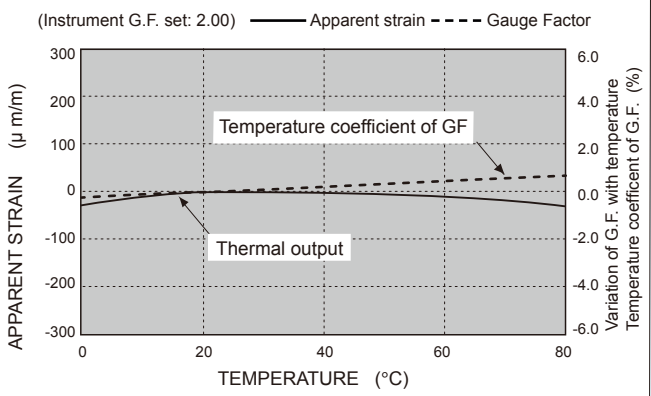

High temperature WELDABLE STRAIN GAUGES

series **AW**



AWM / AWMD / AWH / AWHU / AW / AWC / AWCH

These strain gauges have strain sensing elements fully encapsulated in corrosion-resisting metal tubes made of stainless steel or Inconel (except AW-6-350). The strain gauge backings are also made of the same material, and the gauges are installed by spot welding to metal specimens using a dedicated spot welder.

The maximum operating temperature is 800°C for the AWHU. These gauges are suited to measurement in high temperature harsh environments such as underwater or gas-filled atmosphere, or for long term. The AWC-2B and AWCH-2 are available in 1-Gauge 4-Wire configuration.

<p>AWM -196 ~ +300°C Quarter bridge 3-wire</p> <p>AWM-8-1A Gauge base : Inconel 600 AWM-8-1B Gauge base : SUS304</p>	<p>AW-6 -196 ~ +300°C Quarter bridge 3-wire</p> <p>AW-6-350-11-4FB01LT</p>
<p>AWMD -196 ~ +800°C for dynamic strain Full bridge</p> <p>AWMD-5 Gauge base : Inconel 600 AWMD-8 Gauge base : Inconel 600</p>	<p>AWC -20 ~ +100°C</p> <p>AWC-2B-11-3LQSA 1-Gauge 4-Wire AWC-8B-11-3LTSB Quarter bridge 3-wire</p>
<p>AWH -196 ~ +600°C for static strain Full bridge -196 ~ +650°C for dynamic strain Full bridge</p> <p>AWH-4-7A/AWH-8-7A Gauge base: Inconel 600 AWH-4-7B/AWH-8-7B Gauge base: SUS321</p>	<p>AWCH -196 ~ +200°C 1-Gauge 4-Wire</p> <p>AWCH-2-11-MI2L-05LQSA Gauge base: SUS304</p>
<p>AWHU -196 ~ +800°C Full bridge</p> <p>AWHU-5 Gauge base: Inconel 600 AWHU-8 Gauge base: Inconel 600</p>	

AW series coding system

	(1)	(2)	(3)	(4)	(5)	(6)	(7)	(8)
AWM	-8-	1	B			-2		-17.0
AWMD	-5-		A	KM		-2	(6F)	-1.6Hz*
AWMD	-8-		A			-2		-1.6Hz*
AWH	-8-	7	A			-2		-11.0
AWHU	-5-	9	A	KM		-2	(6F)	-12.7

*: High-pass filter only for AWMD Either one available among 1.6, 7.2 or 16Hz.

(1) Type	(2) Gauge length	(3) Temperature compensation range	(4) Gauge base*1	(5) Option
AWM : static/dynamic 300°C	8: 8mm	0 : -196°C ~ RT 1 : RT ~ +300°C	A: Inconel 600 Applicable thermal expansion coefficient of 11ppm/°C or closer	E: Ground earth F: Compression fittings
AWMD : dynamic only 800°C	5: 5mm 8: 8mm	2 : RT ~ +350°C 3 : RT ~ +400°C	B: AWH SUS321 AWM SUS304 Applicable thermal expansion coefficient of 17ppm/°C or closer	K: Narrow gauge width W=3mm (5mm standard) M: Small junction type of sleeve B φ 2.0mm L=20mm AWHU and AWMD-5 are normally provided with small junction
AWH : static 600°C : dynamic 650°C	4: 4mm 8: 8mm	4 : RT ~ +450°C 5 : RT ~ +500°C		P: NDIS type plug attached*2 R: Bend of gauge backing or pipe
AWHU : static/dynamic 800°C	5: 5mm 8: 8mm	6 : RT ~ +550°C 7 : RT ~ +600°C 8 : RT ~ +650°C 9 : RT ~ +800°C 10 : Others NB1: Dynamic use AWMD is not applicable. NB2: RT Room temperature		Z: Filter-less (AWMD)

*1: Select code A for thermal expansion coefficient of 11ppm/°C or closer, or B for coefficient of 17ppm/°C

*2: For option code P, NDIS plug is attached to the end of cables following Temperature-compensation board or High-pass filter.



AWM / AWMD / AWH / AWHU / AW / AWC / AWCH

(6) MI cable	(7) Supplied cable length	(8) Temperature compensation materials or High-pass filter
2: φ 1.6mm 2m Core cable of heat-resistive copper	No marks: φ 4.1mm shielded vinyl cable of 0.5m Except for standard length, required length is given in bracket Example: 4.5m long to (4.5)	Materials available for temperature-compensation 10.9: SUS430 or equivalent 11.0: Mild steel (ferritic) or equivalent 12.7: INCONEL 600 or equivalent 17.0: SUS304 or equivalent
	(6F): φ 1.6mm shielded fluoroethylene propylene cable (FEP) of 0.5m for AWHU-5/-8, AWMD-5 Except for standard length, required length is given after suffix 6F. Example: 4.5m long to (6F4.5)	High-pass filter for only AWMD 1.6: 1.6Hz 7.2: 7.2Hz 16 : 16Hz

Examples of option

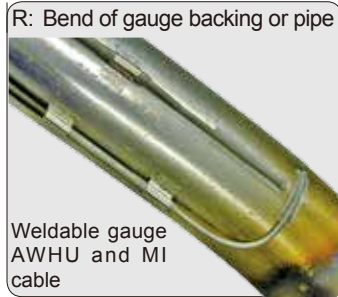
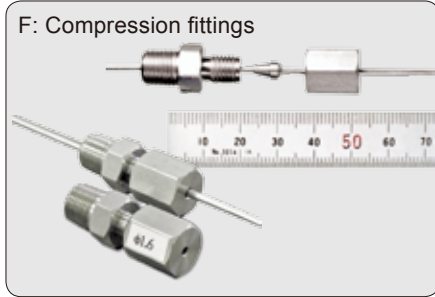

Stainless steel ribbon
Designed to fix cables
Size 5mm x 10m x 0.08mm
10mm x 10m x 0.08mm

Correction for strain gauge height

Unlike adhesive-bonding strain gauges, the sensitive elements in weldable strain gauges sit some distance above the test specimen surface. As a result, the sensitivity to torsion and bending is different. Particularly in bending tests for thin boards, the following equation must be used to correct the sensitivity.

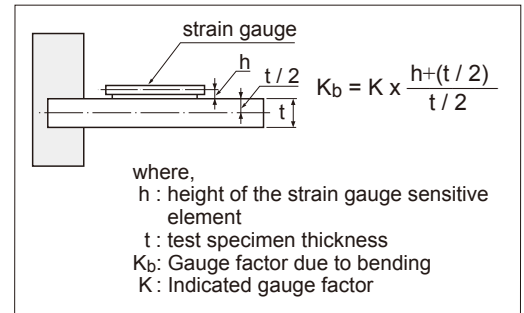

Using resistance welding to install weldable strain gauges

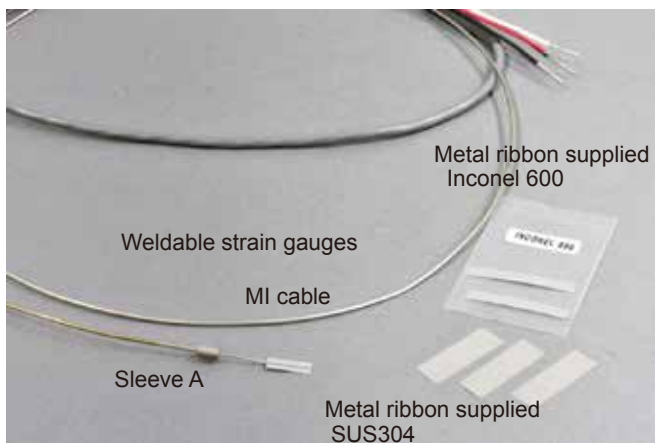

Weldable strain gauges include Metal ribbon of Inconel 600 or SUS304 for trial welding and securing sleeve A and MI cable. To install weldable strain gauges, use Spot Welder W-50RB together with the metal ribbon.

Metal ribbon supplied :
Inconel 600 2 pcs. 30~50 x 5 x 0.08mm
SUS304 3 pcs. 32 x 11 x 0.08mm

Trial Welding
The metal ribbon is used to adjust the welding power of the Spot Welder. If cracks or a hole appear in the ribbon, reduce the power. If the ribbon is unmarked, increase the power.

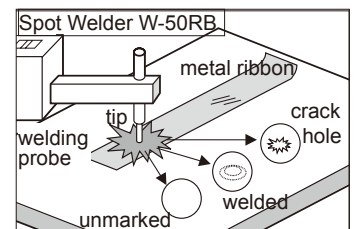

Securing Sleeve A
Align the center of the strain gauge with the marks and press down on the gauge so that it is flush against the test specimen. Sleeve A is secured using the metal ribbon as illustrated.

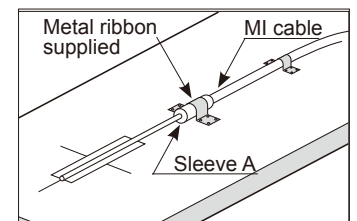

Securing MI cable
To avoid load being placed on secured sleeve A, secure the MI cable with the metal ribbon. To avoid undue strain on the MI cable, secure the cable between the gauge and connecting terminal in a gentle curve.

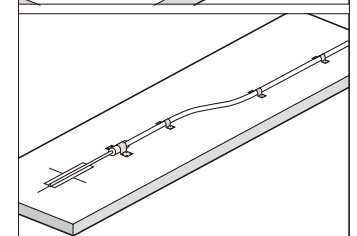

High temperature WELDABLE STRAIN GAUGES

series **AW**



Weldable Strain Gauges AWM / AWMD

AWM-8 Quarter bridge with 3-wire method

Minimum order is 1 gauge.

The AWM is usable up to 300°C for both static and dynamic strain measurement. The backing material is available in Inconel 600 or SUS304 which should be selected according to the test specimen material.



Operating temperature range



Temperature compensation range



Type		Gauge length (mm)	Gauge base		Operating temperature <Temperature compensation range>	Test specimen	Resistance in Ω
			Dimension (mm)	Materials			
Static/Dynamic strain measurement	AWM-8-1A-2-11.0	8	L16xW5xT0.7	Inconel 600	For static/dynamic use -196~+300°C <Room-temperature ~ +300°C>	Mild steel or equivalent SUS304 or equivalent	120
	AWM-8-1B-2-17.0			SUS304			

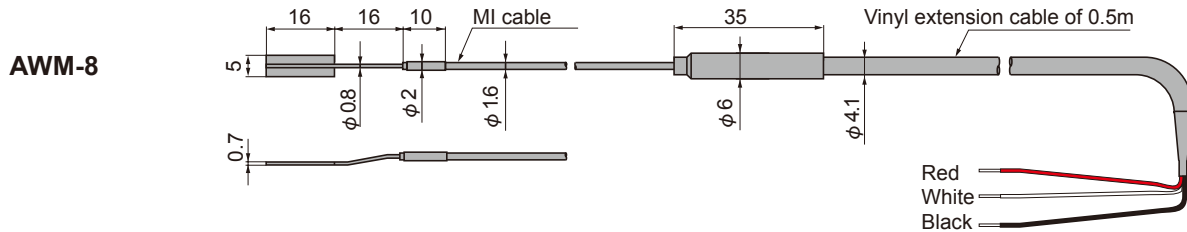

AWMD-5 / AWMD-8 for dynamic strain measurement only Full bridge

Minimum order is 1 gauge.

The AWMD is applicable up to 800°C and it is dedicated to dynamic strain measurement. A high pass filter is a standard accessory. Using the high pass filter, unnecessary direct current component or low frequency component (thermal output, drift etc.) in the measurement signals can be neglected. The DC exciting Dynamic Strainmeter (DC-96A/-97A) or the Smart Dynamic Strain Recorder DC-204R, Multi-Recorder TMR-200 should be used for the measurement.



Operating temperature range



Temperature compensation range Not available

Type		Gauge length (mm)	Gauge base		Operating temperature <Temperature compensation range>	Test specimen	Resistance in Ω
			Dimension (mm)	Materials			
Dynamic strain measurement	AWMD-5-AKMS-2(6F)-1.6Hz*	5	L10xW3xT0.7	Inconel 600	-196~+800°C < N/A >	Inconel 600 or equivalent	60
	AWMD-8-A-2-1.6Hz*	8	L16xW5xT0.7	Inconel 600			120

*: High-pass filter only for AWMD Either one available among 1.6, 7.2 or 16Hz.

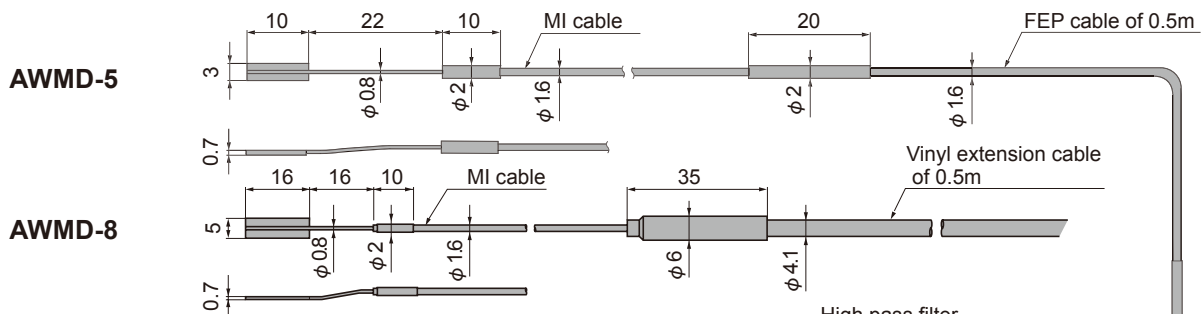

Plug-in NDIS connector of TML Dynamic Strainmeter

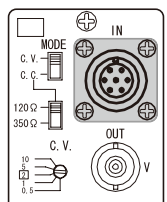

TML Bridge Box Full bridge wiring or NDIS plug connector

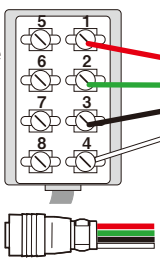

Red Green Black White

Option code P for NDIS plug connector available with AWMD/AWH/AWHU attached to Temperature-compensation board or High-pass filter



Weldable Strain Gauges AWH / AWHU

AWH-4 / AWH-8 Full bridge

The backing material is available in Inconel 600 or SUS321 which should be selected according to the test specimen material. Although the gauge has a half bridge construction consisting of active and dummy gauges, the measurement is made by the full bridge method using the supplied temperature compensation circuit board. The maximum operating temperature is 600°C for static strain measurement and 650°C for dynamic strain measurement.



Minimum order is 1 gauge.

Operating temperature range
 Static strain measurement -196°C ~ +600°C
 Dynamic strain measurement -196°C ~ +650°C
 Temperature compensation range
 Static strain measurement RT ~ +600°C
 Dynamic strain measurement RT ~ +650°C

Type	Gauge length (mm)	Gauge base		Operating temperature <Temperature compensation range>	Test specimen	Resistance in Ω
		Dimension(mm)	Materials			
AWH-4-7A-2-11.0	4	L10xW3xT0.8	Inconel 600	For static use -196~+600°C <Room-temperature ~ +600°C>	Mild steel or equivalent	60
AWH-4-7B-2-17.0			SUS321		SUS304 or equivalent	
AWH-8-7A-2-11.0	8	L16xW5xT0.8	Inconel 600	For dynamic use -196~+650°C <Room-temperature ~ +650°C >	Mild steel or equivalent	120
AWH-8-7B-2-17.0			SUS321		SUS304 or equivalent	

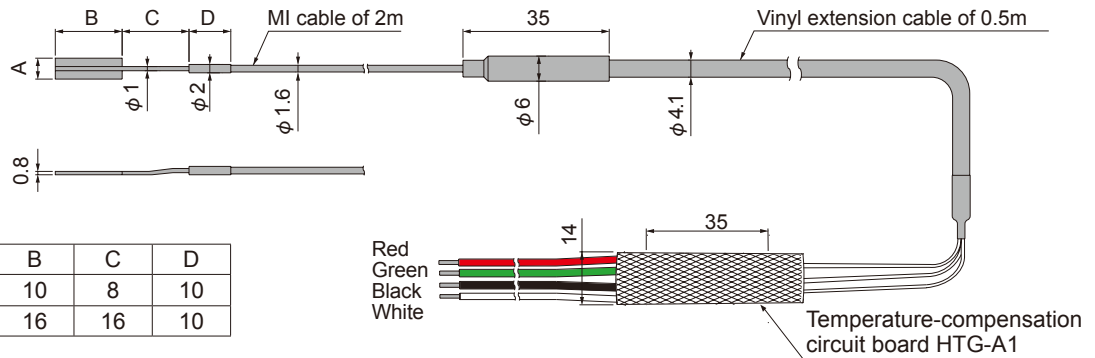

Type	A	B	C	D
AWH-4	3	10	8	10
AWH-8	5	16	16	10

AWHU-5 / AWHU-8 Full bridge

These gauges are usable up to 800°C for both static and dynamic strain measurement. Although the gauge has a half bridge construction consisting of active and dummy gauges, the measurement is made by the full bridge method using the supplied temperature compensation circuit board. The gauge base, junction part and cable of these gauges are constructed small as a standard specification and the gauges are suited for being mounted on a narrow or a curved part.



Minimum order is 1 gauge.

Operating temperature range -196°C ~ +800°C
 Temperature compensation range RT ~ +800°C

Type	Gauge length (mm)	Gauge base		Operating temperature <Temperature compensation range>	Test specimen	Resistance in Ω
		Dimension (mm)	Materials			
Static/Dynamic measurement	AWHU-5-9AKM-2(6F)-12.7	5	L10xW3xT0.8	For static/dynamic use -196 ~+800°C <Room-temperature ~+800°C >	Inconel 600 or equivalent	60
	AWHU-8-9AKM-2(6F)-12.7	8	L16xW3xT0.8			120

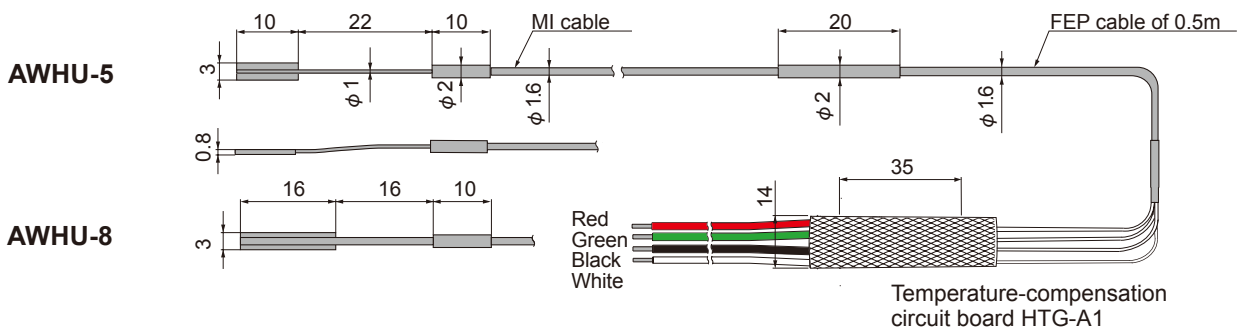

High temperature WELDABLE STRAIN GAUGES

series **AW**



Weldable Strain Gauges AW / AWC / AWCH

These gauges have corrosion-resisting stainless steel backing with thickness of 0.08mm. They are easily installed by using the dedicated spot welder W-50RB.

AW-6-350-11-4FB01LT Quarter bridge with 3-wire method

Minimum order is 5 gauges.

These gauges are suited for strain measurement in high temperature up to 300°C, for measurement of specimen to which adhesion is not applicable or for long term measurement.

Operating temperature range



Temperature compensation range



Type	Gauge length (mm)	Gauge base		Operating temperature <Temperature compensation range>	Test specimen	Resistance in Ω
		Dimension(mm)	Materials			
AW-6-350-11-4FB01LT	6	L24xW5	SUS304	-196~+300°C <+10 ~ +100°C>	Mild steel	350

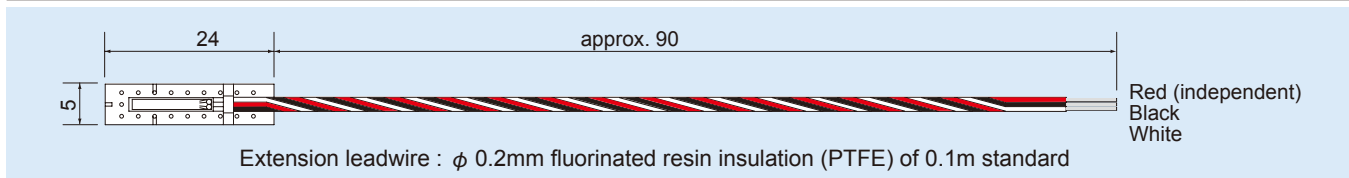

AWC-2B-11-3LQSA 1-Gauge 4-Wire system

AWC-8B-11-3LTSB Quarter bridge 3-wire method

Minimum order is 1 gauge.

These gauges are fully encapsulated in a stainless steel tube. It enables long term strain measurement in harsh environment.

Operating temperature range



Temperature compensation range



Type	Gauge length (mm)	Gauge base		Operating temperature <Temperature compensation range>	Test specimen	Resistance in Ω
		Dimension(mm)	Materials			
AWC-2B-11-3LQSA	2	L16xW5xT0.5	SUS304	-20~+100°C <0 ~ +100°C >	Mild steel	120
AWC-8B-11-3LTSB	8	L28xW5xT1		-20~+100°C <+10 ~ +100°C >		

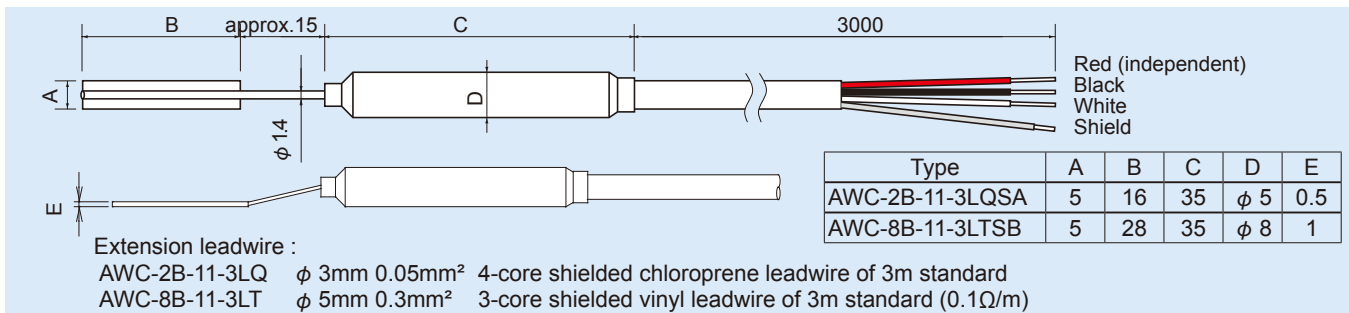

AWCH-2-11-MI2L-05LQSA 1-Gauge 4-Wire system

These gauges are fully encapsulated in compact size of stainless steel tube. These are designed for only 1-Gauge 4-Wire system with our data logger and can measure up to 200°C.

Operating temperature range



Temperature compensation range



Type	Gauge length (mm)	Gauge base		Operating temperature <Temperature compensation range>	Test specimen	Resistance in Ω
		Dimension(mm)	Materials			
AWCH-2-11-MI2L-05LQSA	2	L16xW5xT0.5	SUS304	-196~+200°C <0 ~ +150°C >	Mild steel	120

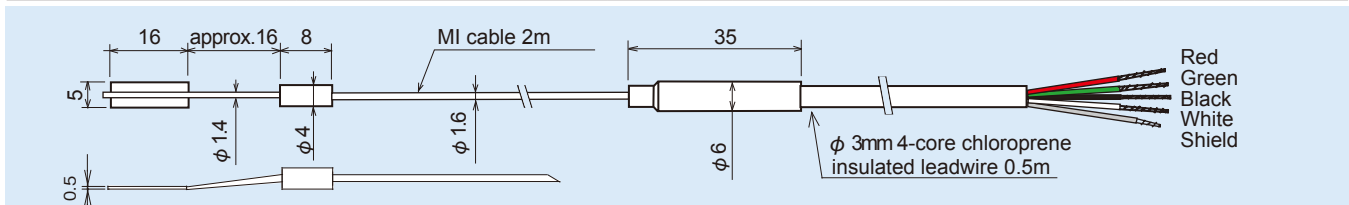



High temperature WELDABLE STRAIN GAUGES series AW

SPOT WELDER W-50RB



This is a capacitive charge spot welder used for installing weldable strain gauges and fixing leadwires. The welding energy is controlled in 2 ranges of 1~10/5~50 watt second continuously, and a stabilizing circuit cancels the effect of changes in the power source voltage. As projecting parts such as electrical cables are packed inside, these are extremely convenient for field applications.

SPECIFICATIONS

Welding energy	1~10 watt sec./5~50 watt sec. continuous 60 watt sec. Max. (110Vac 50Hz)
Output voltage	approx. 32V Max.
Output pulse width	approx. 5 msec.
Repetition use	2 welds/sec. at 50 watt sec.
Rated output	20 min./1.5 welds/sec. at 50 watt sec.
Weldable probe	III type probe
Welding force	4.9~19.8N
Welding tip	Arm φ 3mm, Nose φ 1mm
Cable length	2m
Operation environment	0~+50°C 85%RH or less (no condensation allowed)
Power source	90~110Vac., 50/60Hz 550VA peak(160msec.), 210VA/2 welds/sec.
Dimensions	300(W) x 195(H) x 195(D) mm
Weight	13kgs.

Standard accessory

- Operation manual 1
- AC power cable (CR-01) 1
- Welding tip 3
- Protective cap..... 2
- Abrasive paper (#400) 5
- Carrying belt 1
- Hexagon head wrench 1

Examples of installation

Installing a weldable gauge

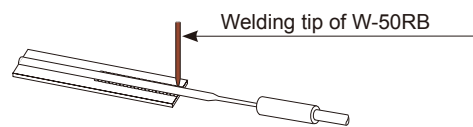

Fixing a MI cable

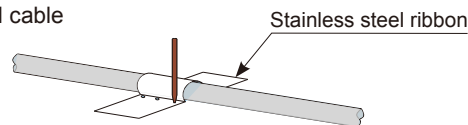

Fixing a fluorinated insulated cable

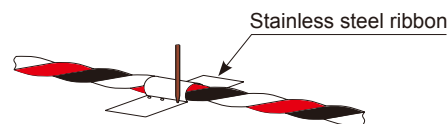

INDIVIDUAL TEST DATA

AWM, AWH and AWHU are always examined and supplied with individual test data including serial number, gauge factor, thermal output curve, bridge configuration, etc.

CAPACITATED HIGH TEMPERATURE STRAIN GAUGE AWH GAUGE-TEST DATA

Serial No: H180K-01

SPECIFICATIONS Gauge type: AWH-5-7A-2-11.0 Serial No: H180K-01 Gauge Factor: Original G.F. K ₀ = 3.75, Adjusted G.F. K ₀₂₀ = 3.52 Gauge resistance at room temperature: Dummy element R _d = 111.100 Ω, Dummy element R ₀ = 120.886 Ω Object material: Equivalent to Mild Steel Compensation: Temperature range 20 ~ 600 °C Length: 2 m, Calibrated with heated 1 m MI cable: Temperature R ₀₂ = 5.6 Ω Compensation resistor: Balancing R ₀₁ = 3.2 Ω Sensitivity shift: -310 ppm/°C Wiring: The supplied temperature compensation circuit board HTG-A1 includes all of temperature compensation, balance and fixed resistors. Connect the end lead wires of the gauge to TML readout instrument or its switching box in order of Red, Green, Black and White in the same manner as TML transducer connection.	CHARACTERISTICS
--	----------------------------

Temperature (°C)	Thermal Output 0-meter	Thermal Output 1-meter	Thermal Output 2-meter
21	0	1.405	0
103	-152	1.405	-149
202	-283	1.405	-253
300	-299	1.405	-235
400	-263	1.405	-243
500	-150	1.405	-124
599	30	1.405	67

CALIBRATION TABLE

Temperature (°C)	Thermal Output 0-meter	Thermal Output 1-meter	Thermal Output 2-meter
21	0	1.405	0
103	-152	1.405	-149
202	-283	1.405	-253
300	-299	1.405	-235
400	-263	1.405	-243
500	-150	1.405	-124
599	30	1.405	67

Tokyo Sokki Kenkyujo Co., Ltd. 5-2, Misawa-Chi-Chome, Suginami-Ku, Tokyo 140-8566, JAPAN

TEMPERATURE STRAIN GAUGE AWHU GAUGE-TEST DATA

Serial No: H185C-01

SPECIFICATIONS Gauge type: AWHU-5-7A-2-11.0 Serial No: H185C-01 Gauge Factor: Original G.F. K ₀ = 2.08, Adjusted G.F. K ₀₂₀ = 2.05 Gauge resistance at room temperature: Dummy element R _d = 113.057 Ω, Dummy element R ₀ = 120.688 Ω Object material: Inconel600 Compensation: Temperature range 20 ~ 800 °C Length: 2 m, Calibrated with heated 1 m MI cable: Temperature R ₀₂ = 5.6 Ω Compensation resistor: Balancing R ₀₁ = 16.7 Ω Sensitivity shift: -310 ppm/°C Wiring: The supplied temperature compensation circuit board HTG-A1 includes all of temperature compensation, balance and fixed resistors. Connect the end lead wires of the gauge to TML readout instrument or its switching box in order of Red, Green, Black and White in the same manner as TML transducer connection.	CHARACTERISTICS
--	----------------------------

Temperature (°C)	Thermal Output 0-meter	Thermal Output 1-meter	Thermal Output 2-meter
21	0	1.405	0
103	-152	1.405	-149
202	-283	1.405	-253
300	-299	1.405	-235
400	-263	1.405	-243
500	-150	1.405	-124
599	30	1.405	67

CALIBRATION TABLE

Temperature (°C)	Thermal Output 0-meter	Thermal Output 1-meter	Thermal Output 2-meter
21	0	1.405	0
103	-152	1.405	-149
202	-283	1.405	-253
300	-299	1.405	-235
400	-263	1.405	-243
500	-150	1.405	-124
599	30	1.405	67

Tokyo Sokki Kenkyujo Co., Ltd. 5-2, Misawa-Chi-Chome, Suginami-Ku, Tokyo 140-8566, JAPAN

POLYESTER STRAIN GAUGES

series P/PF

Operating temperature range
-20°C +80°C

Temperature compensation range
+10°C +80°C

Suffix code for temperature compensation materials
-11: Mild steel

For ordering, the above suffix code should be added to the basic gauge type.



Applicable adhesives

CN-E	-20 ~ +80°C
RP-2	-20 ~ +80°C
PS	-20 ~ +80°C

STEEL, CONCRETE, MORTAR MATERIAL USE

Gauge pattern	Basic type	Gauge size		Backing		Resistance Ω
		L	W	L	W	

series P



These are wire strain gauges utilizing a transparent plastic backing impregnated with polyester resin. The gauge length is available in 3 ranges of 60, 90 and 120mm, so it is suited to the measurement of concrete strain. Since the backing is transparent, the bonding position can easily be checked in the installation works.

Single element

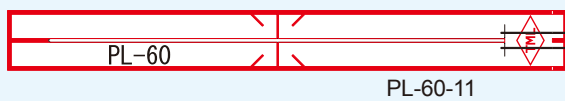

Example of type number designation.

PL-60 -11 -3LJC-F

- PL-60: Basic strain gauge type
- 11: Self-temperature-compensation for Mild steel
- 3LJC-F: CE compliant leadwire

Single-element	Each package contains 10 gauges.				
PL-60-11	60	1	74	8	120
PL-90-11	90	1	104	8	120
PL-120-11	120	1	134	8	120

0°/90° 2-element stacked Rosette

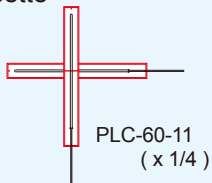

0°/45°/90° 3-element stacked Rosette

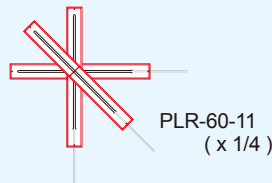

	Each package contains 10 gauges.				
0°/90° 2-element stacked Rosette					
PLC-60-11	60	1	74	74	120
0°/45°/90° 3-element stacked Rosette					
PLR-60-11	60	1	74	74	120

series PF



These are foil strain gauges utilizing a polyester resin backing which is the same as the P series. The gauge length is available in 3 ranges of 10, 20 and 30mm, so it is suited mainly to strain measurement on concrete or mortar. The backing is transparent and the installation is easy.

Single element

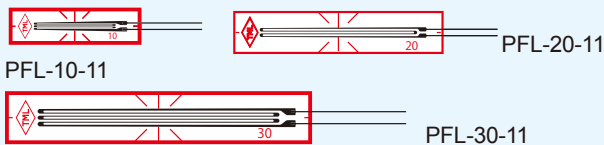

Single element	Each package contains 10 gauges.				
PFL-10-11	10	0.9	17.5	5	120
PFL-20-11	20	1.2	28	6	120
PFL-30-11	30	2.3	40	7	120

0°/90° 2-element stacked Rosette

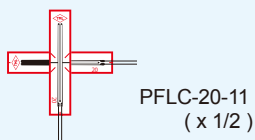

0°/45°/90° 3-element stacked Rosette

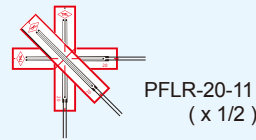

	Each package contains 10 gauges.				
0°/90° 2-element stacked Rosette					
PFLC-20-11	20	1.2	28	28	120
PFLC-30-11	30	2.3	40	40	120
0°/45°/90° 3-element stacked Rosette					
PFLR-20-11	20	1.2	28	28	120
PFLR-30-11	30	2.3	40	40	120

Recommendable integral leadwire for P/PF series

Application	Leadwires	Operating temperature (°C)	Leadwire code exemplified
General use (temperature unchanged during measurement)	Paralleled vinyl -LJB-F/ -LJC-F	-20~ +80	PL-60-11-3LJB-F PFL-10-11-3LJC-F
General use	3-wire paralleled vinyl -LJBT-F/-LJCT-F	-20~ +80	PL-60-11-3LJBT-F PFL-10-11-3LJCT-F
1-gauge 4-wire measurement	0.08mm ² polypropylene 4-wire paralleled -LQM-F	-20~ +100	PL-60-11-3LQM-F

METAL BACKING STRAIN GAUGES series FLM/WFLM

Operating temperature range
 -20°C +80°C

Temperature compensation range
 +10°C +80°C



Suffix code for temperature compensation materials
 -11: Mild steel

For ordering, the above suffix code should be added to the basic gauge type.

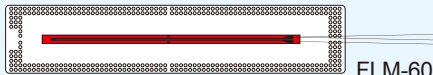

Applicable adhesives PS -20 ~ +80°C

CONCRETE, MORTAR MATERIAL USE

Gauge pattern	Basic type	Gauge size		Backing			Resist- ance Ω																						
		L	W	L	W	T																							
<p>These strain gauges have thin stainless steel backings which prevent the penetration of moisture from the reverse sides. This construction is aimed for successful strain measurement on concrete surface. The WFLM gauges have moisture proofing over-coating and integral leadwire in addition to the stainless steel backing. It is intended for long term measurement or measurement on underwater-curing concrete.</p> <p>Single element</p>  <p>FLM-60-11 (x 1/2)</p> <p>Refer to pages 19-20 for applicable integral leadwire.</p> <p>WATERPROOF TYPE Single element 0.09mm² 3-wire twisted cross-linked polyethylene integral leadwire of 2m -2LJQTA Total leadwire resistance per meter : 0.4Ω</p>  <p>WFLM-60-11-2LJQTA (x 1/2) Integral leadwire length longer than 2m is available.</p>	<p>Example of type number designation.</p> <p>FLM-30 -11 -2LJCT</p> <p>↑ ↑ ↑ Basic strain gauge type Self-temperature-compensation for Mild steel Length in meter and type of integral leadwire</p> <p>Single element Each package contains 10 gauges.</p> <table border="1"> <tr> <td>FLM-30-11</td> <td>30</td> <td>0.5</td> <td>60</td> <td>18</td> <td>0.12</td> <td>120</td> </tr> <tr> <td>FLM-60-11</td> <td>60</td> <td>0.7</td> <td>90</td> <td>18</td> <td>0.12</td> <td>120</td> </tr> </table> <p>Single element Each package contains 10 gauges.</p> <table border="1"> <tr> <td>WFLM-30-11-2LJQTA</td> <td>30</td> <td>0.5</td> <td>60</td> <td>18</td> <td>4</td> <td>120</td> </tr> <tr> <td>WFLM-60-11-2LJQTA</td> <td>60</td> <td>0.7</td> <td>90</td> <td>18</td> <td>4</td> <td>120</td> </tr> </table>	FLM-30-11	30	0.5	60	18	0.12	120	FLM-60-11	60	0.7	90	18	0.12	120	WFLM-30-11-2LJQTA	30	0.5	60	18	4	120	WFLM-60-11-2LJQTA	60	0.7	90	18	4	120
FLM-30-11	30	0.5	60	18	0.12	120																							
FLM-60-11	60	0.7	90	18	0.12	120																							
WFLM-30-11-2LJQTA	30	0.5	60	18	4	120																							
WFLM-60-11-2LJQTA	60	0.7	90	18	4	120																							

MOLD STRAIN GAUGES series PM

Operating temperature range
 -20°C +60°C

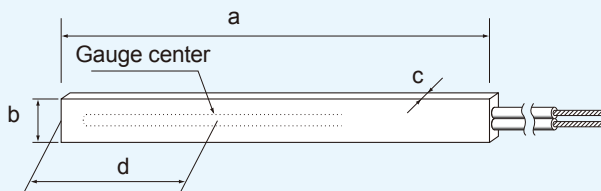

CONCRETE, MORTAR MATERIAL USE

Gauge pattern	Basic type	Gauge size		Backing				Resist- ance Ω									
		L	W	L	W	a	b		c	d							
<p>These gauges are designed exclusively for the measurement of internal strain of concrete or mortar under loading test. These are embedded into the measurement position when the concrete or mortar is placed. The gauges have a construction of the sensing element sealed into the backing made of acrylic resin for waterproofing.</p>  <p>Integral leadwire length longer than 2m are available.</p>	<p>Example of type number designation.</p> <p>PML-60 -11 -2LJD</p> <p>↑ ↑ ↑ Basic strain gauge type Self-temperature-compensation for Mild steel Length in meter and type of integral leadwire 0.12mm paralleled vinyl leadwire of 2-meter</p> <p>Single element Each package contains 5 gauges.</p> <table border="1"> <tr> <td>PML-60 -2LJD</td> <td>60</td> <td>1</td> <td>125</td> <td>13</td> <td>5</td> <td>40</td> <td>120</td> </tr> <tr> <td>PML-120 -2LJDT</td> <td>120</td> <td>1</td> <td>180</td> <td>13</td> <td>5</td> <td>65</td> <td>120</td> </tr> </table> <p>For long-term measurement of concrete structure, use Strain Transducer KM (refer to page 69).</p>	PML-60 -2LJD	60	1	125	13	5	40	120	PML-120 -2LJDT	120	1	180	13	5	65	120
PML-60 -2LJD	60	1	125	13	5	40	120										
PML-120 -2LJDT	120	1	180	13	5	65	120										

Strain Gauge Installation on Concrete, Mortar

Three methods for installing strain gauges on concrete and mortar are introduced.

Test Condition and Applicable Strain Gauges

Test Conditions	Strain Gauge	Strain Gauge Adhesive
Immediate testing indoors	PF or P series	CN, CN-E, P-2
Somewhat prolonged testing outdoors	PF or P series	RP-2
Long term testing outdoors	WFLM series	PS

If the strain gauge is used only for short-term loading test indoors, coating over the strain gauge is not required. In this case, if the surface of the mortar or concrete is smooth and fully dry, precoating is also not required.

Concrete or Mortar surface preparation

1. Preparing

Remove any laitance, paint or other soiling from gauge installation area on the test specimen to provide a clean contact surface. Because the adhesive may not harden if the gauge installation area on the test specimen is wet, use TML surface preparation agent AC-1 to remove any moisture.

2. Sanding

Evenly sand an area 20mm to 30mm larger than the strain gauge to be installed with abrasive paper. Depending on the test specimen material, grade 80 to 120 abrasive paper should be used to finish the surface.

3. Cleaning

Clean the abraded surface with industrial tissue or cloth dampened with a small amount of a solvent such as acetone.

Precoating with PS adhesive

The purpose of precoating is, firstly, to render the surface of the mortar or concrete flat and provide surface to which the strain gauge will readily bond, and secondly, to act as a barrier against any dampness that is exuded from the surface of the concrete or mortar, thereby preventing absorption of moisture by the underside of the strain gauge. A special purpose PS adhesive is used as the precoat.

1. Cutting gauge binder

Cut the gauge binder supplied with the strain gauge about 5mm in from the fold.

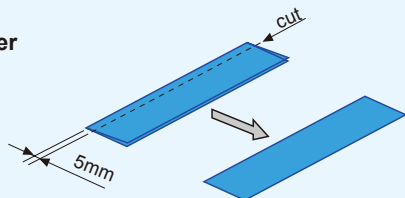

2. Masking

Use packing tape to mask an area roughly 10mm larger on each side than the cut piece of gauge binder.

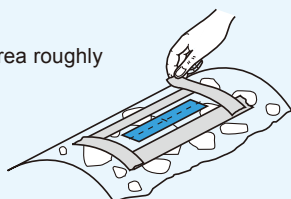

3. Applying PS adhesive

Following the procedure given in the instructions, mix the PS adhesive. Brush the adhesive fully into the mortar or concrete. Apply another coat of the PS adhesive to the strain gauge installation surface so that a layer 0.5mm to 1mm thick is formed.

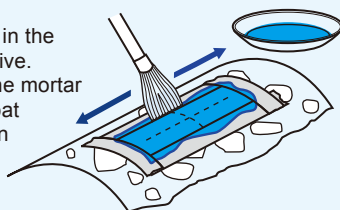

4. Finishing surface with the gauge binder

Lay the cut piece of binder onto the adhesive pressing it into place gradually from one end so that no air bubbles are trapped under the binder. Press down lightly on the piece of gauge binder to expel any excess adhesive and air bubbles.



Removal of gauge binder :

Once the adhesive has hardened, peel off the piece of gauge binder and install the strain gauge.

For a laboratory load test on a mortar specimen

Example of Installation using CN-E adhesive

Test specimen	Mortar aged 2 months (ϕ 100x200mm)
Strain Gauge	PFL-30-11-3LT
Strain Gauge Adhesive	CN-E
Leadwire	10-core/ ϕ 0.12mm, vinyl-covered Quarter bridge 3-wire system, 3m

Use CN-E adhesive to attach the strain gauge to mortar specimen surface precoated with PS adhesive. Secure the leadwires with vinyl tape.

When bonding a strain gauge having long gauge backing with CN-E adhesive, position the strain gauge to the measuring point and fix the top of the gauge (opposite side to the gauge leads) with adhesive tape.

Then lift the strain gauge from the gauge leads side, apply the adhesive to the back of the gauge, and return the gauge to the original measuring point. Cover the strain gauge with a polyethylene sheet and apply finger pressure from the center of the gauge toward both ends so as to squeeze out air bubbles.



For outdoor test with a measurement period of 2 weeks

Example of Installation using RP-2 adhesive

Strain Gauge	PL-60-11
Strain Gauge Adhesive	RP-2
Connecting terminals	TFY-2M
Leadwire	ϕ 5mm, 3-core shielded vinyl cable
Coating materials	W-1 + SB tape + VM tape

Mix the RP-2 adhesive as described in the adhesive instructions. Apply a thin layer of the adhesive uniformly over the back of the strain gauge and the strain gauge installation area on the precoated surface. Place the strain gauge onto the installation position, and apply a pressure of 0.05~0.3MPa until the adhesive hardens. Once the adhesive hardens, install the connecting terminals using CN-E adhesive. Coat the strain gauge and the connecting terminals with the W-1 materials. Solder leadwires to the connecting terminals, then secure the leadwires with a cut SB tape.

If any metal portions of the leadwires or connecting terminals are not covered by the coating, reapply the W-1 and SB tape. Cut a piece of VM tape slightly larger than the layer of SB tape coating and press it down into place.

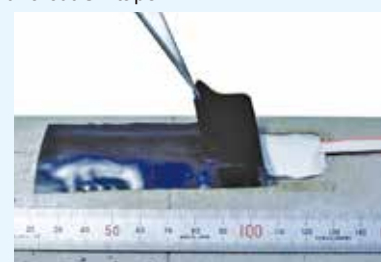

For a long term outdoor measurement

Example of Installation using PS adhesive

Strain Gauge	WFLM-60-11-2LT
Strain Gauge Adhesive	PS

Position a strain gauge WFLM-60-11-2LT on PS-adhesive-precoated area and secure the leadwire temporarily with cellophane tape. Turn the WFLM strain gauge over and apply a generous amount of mixed PS adhesive to the underside of the gauge base and the precoated surface. Return the gauge to its previous installation position. Press lightly down on the WFLM strain gauge, working from the center out to the edges, expel any excess PS adhesive and air bubbles. To bond firmly, the metal base of the WFLM strain gauge should be fully enveloped from above and below by the PS adhesive.

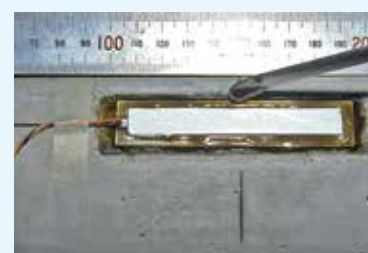

MOLD STRAIN GAUGES series PMF

Operating temperature range
 -20°C  +60°C

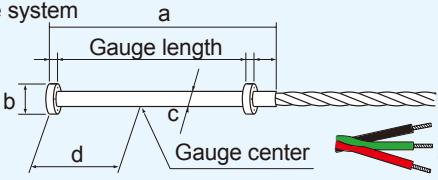
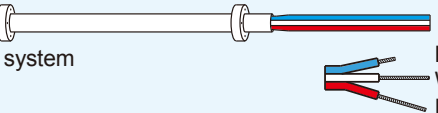

CONCRETE, MORTAR MATERIAL USE

Gauge pattern	Basic type	Gauge length (mm)	Backing	Resistance Ω																																			
<p>These gauges are designed for the measurement of internal strain of concrete or mortar under loading test. These can also be used for short-term measurement of the behavior of concrete. These are embedded into the measurement position when the concrete or mortar is placed. The gauges employ super engineering plastics as the backing for sealing the sensing element, which provides excellent waterproofing. A temperature-integrated type PMFL-T is available for measurement of both strain and temperature using our data loggers.</p> <p>Single element 0.09mm² 3-wire cross-linked vinyl leadwire of 2m -2LJRTA Total leadwire resistance per meter : 0.4Ω</p>  <p>3-wire system Black Green Red (independent)</p> <p>Temperature sensor integrated 0.08mm² integral cross-linked vinyl leadwire of 3m -3TLJBT Total leadwire resistance per meter : 0.44Ω</p>  <p>3-wire system Blue (Cu) White (Cu-Ni) Red (Cu-independent)</p>	<p>Example of type number designation. PMFL-50 -2LJRTA ↑ ↑ ↑ Basic strain gauge type Length in meter and type of integral leadwire 3-wire twisted cross-linked vinyl leadwire</p> <p>For long-term measurement of concrete structure, use Strain Transducer KM (refer to page 69).</p> <p>Each package contains 10 gauges.</p>	<table border="1"> <thead> <tr> <th></th> <th>a</th> <th>b</th> <th>c</th> <th>d</th> <th></th> </tr> </thead> <tbody> <tr> <td>PMFL-50 -2LJRTA</td> <td>50</td> <td>60</td> <td>ϕ 8</td> <td>ϕ 4</td> <td>27</td> </tr> <tr> <td>PMFL-60 -2LJRTA</td> <td>60</td> <td>70</td> <td>ϕ 8</td> <td>ϕ 4</td> <td>32</td> </tr> </tbody> </table> <p>Integral leadwire length other than 2m are available.</p>		a	b	c	d		PMFL-50 -2LJRTA	50	60	ϕ 8	ϕ 4	27	PMFL-60 -2LJRTA	60	70	ϕ 8	ϕ 4	32	<table border="1"> <thead> <tr> <th></th> <th>a</th> <th>b</th> <th>c</th> <th>d</th> <th></th> </tr> </thead> <tbody> <tr> <td>PMFL-50T -3TLJBT</td> <td>50</td> <td>60</td> <td>ϕ 8</td> <td>ϕ 4</td> <td>27</td> </tr> <tr> <td>PMFL-60T -3TLJBT</td> <td>60</td> <td>70</td> <td>ϕ 8</td> <td>ϕ 4</td> <td>32</td> </tr> </tbody> </table> <p>Each package contains 10 gauges.</p>		a	b	c	d		PMFL-50T -3TLJBT	50	60	ϕ 8	ϕ 4	27	PMFL-60T -3TLJBT	60	70	ϕ 8	ϕ 4	32
	a	b	c	d																																			
PMFL-50 -2LJRTA	50	60	ϕ 8	ϕ 4	27																																		
PMFL-60 -2LJRTA	60	70	ϕ 8	ϕ 4	32																																		
	a	b	c	d																																			
PMFL-50T -3TLJBT	50	60	ϕ 8	ϕ 4	27																																		
PMFL-60T -3TLJBT	60	70	ϕ 8	ϕ 4	32																																		

Asphalt Mold STRAIN GAUGES series PMFLS

Operating temperature range
 -20°C  +60°C



Suffix code for temperature compensation materials
 -50: Asphalt

For ordering, the above suffix code should be added to the basic gauge type.

ASPHALT PAVEMENT USE

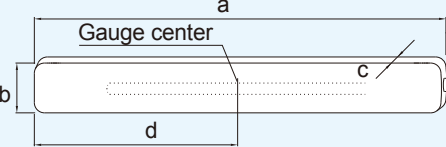
Gauge pattern	Basic type	Gauge length (mm)	Backing	Resistance Ω																							
<p>The gauges are embedded in asphalt and used for strain measurement in loading test such as rolling compaction. The material of the backing is super engineering plastics featuring high temperature resistivity and waterproofing performance. The gauges withstand a high temperature up to 200°C during placement of asphalt, and the operating temperature range is -20 to +60°C.</p> <p>3-wire system</p>  <p>ϕ 6mm 4-wire shielded chloroprene cable of 2m -2LTSC Total leadwire resistance per meter : 0.11Ω</p>	<p>Example of type number designation. PMFLS-60 -50 -2LTSC ↑ ↑ ↑ Basic strain gauge type Length in meter and type of integral leadwire 4-wire shielded chloroprene cable of 2-meter Self-temperature-compensation number</p> <p>Minimum order is 1 gauge.</p>	<table border="1"> <thead> <tr> <th></th> <th>a</th> <th>b</th> <th>c</th> <th>d</th> <th></th> </tr> </thead> <tbody> <tr> <td>PMFLS-60-50-2LTSC</td> <td>60</td> <td>120</td> <td>13</td> <td>7</td> <td>60</td> </tr> </tbody> </table> <p>Black White Red (independent) Shield</p>		a	b	c	d		PMFLS-60-50-2LTSC	60	120	13	7	60	<table border="1"> <thead> <tr> <th></th> <th>a</th> <th>b</th> <th>c</th> <th>d</th> <th></th> </tr> </thead> <tbody> <tr> <td>PMFLS-60-50-2LTSC</td> <td>60</td> <td>120</td> <td>13</td> <td>7</td> <td>60</td> </tr> </tbody> </table>		a	b	c	d		PMFLS-60-50-2LTSC	60	120	13	7	60
	a	b	c	d																							
PMFLS-60-50-2LTSC	60	120	13	7	60																						
	a	b	c	d																							
PMFLS-60-50-2LTSC	60	120	13	7	60																						

Civil Engineering use series KM/KM-HAS STRAIN TRANSDUCERS



Operating temperature range
 -20°C +180°C

STRAIN TRANSDUCER KM



The KM series are embedment type transducers designed for measurement of internal strain of materials such as concrete and synthetic resin not only in their hardened state but also in curing process. The apparent elastic modulus is as low as approx. 40N/mm², and they are ideally suited to strain measurement during the very early stage of curing (except KM-A and KM-AT). They are totally impervious to moisture and exhibit excellent stability for long-term strain measurement. The KM-100B and KM-100BT are also applicable to the measurement of surface strain of steel or concrete structures by using optional collars for surface installation.

The KM series is compliant to CE marking except for KM-30 and KM-50F.

TYPE	Dimensions (mm)						Weight (g)
	A	B	C	D	E	F	
KM-30	34	12	10	31	3	M3 Depth 4	12
KM-50F	54	20	17	50	4	M3 Depth 6	45
KM-100A KM-100B	104	20	17	100	4	M3 Depth 6	75
KM-100HB	104	20	17	100	4	M3 Depth 6	80
KM-200A	205	28	23	200	5	M5 Depth 8	220
KM-100AT KM-100BT	104	20	17	100	4	M3 Depth 6	75
KM-200AT	205	28	23	200	5	M5 Depth 8	220

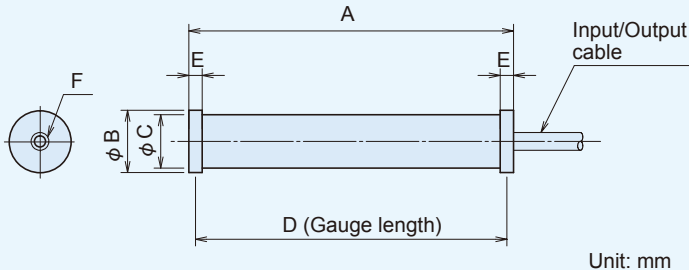

SPECIFICATIONS

Type	KM-30	KM-50F	KM-100A	KM-100B	KM-100HB	KM-200A	KM-100AT	KM-100BT	KM-200AT
Capacity	±5000 x 10 ⁻⁶ strain								
Gauge length	31mm	50mm	100mm		200mm	100mm		200mm	
Rated output (approximately)	2.5mV/V (5000 x 10 ⁻⁶)	4mV/V (8000 x 10 ⁻⁶)	2.5mV/V (5000 x 10 ⁻⁶)		5.0mV/V (10000 x 10 ⁻⁶)	2.5mV/V (5000 x 10 ⁻⁶)		5.0mV/V (10000 x 10 ⁻⁶)	
Non-linearity	1%RO								
Apparent elastic modulus	40N/mm ²		1000N/mm ²	40N/mm ²		1000N/mm ²		40N/mm ²	1000N/mm ²
Integral temperature	N/A		*1 Strain gauge (350Ω Quarter bridge 3-wire method :50x 10 ⁻⁶ strain/°C)			*2 Thermocouple T			
Temperature range	-20~+60°C		-20~+80°C		-20~+180°C	-20~+80°C			
Input/Output	120Ω Half bridge		350Ω Full bridge						

*1 Relative temperature measurement possible
 *2 Real temperature measurement possible

Input/Output cable

KM-30	φ 2.4mm	0.04mm ²	3-core shielded Vinyl cable	2m cable-end free
KM-50F	φ 6mm	0.35mm ²	4-core shielded Chloroprene cable	2m cable-end free
KM-100A/-100B	φ 9mm	0.3mm ²	5-core shielded Chloroprene cable	2m cable-end free
KM-100HB	φ 6mm	0.3mm ²	5-core shielded Fluoroplastic cable	2m cable-end free
KM-200A	φ 11.5mm	0.5mm ²	5-core shielded Chloroprene cable	2m cable-end free
KM-100AT/-100BT	φ 9mm	0.3mm ²	4-core shielded T-thermocouple compound cable	2m cable-end free
KM-200AT	φ 11.5mm	0.5mm ²	4-core shielded T-thermocouple compound cable	2m cable-end free

For use of internal strain measurement

The KM Strain Transducers make possible strain measurement in materials such as concrete which undergo transition from a compliant state to a hardened state. The KM is designed to measure various strains produced by external force, ambient temperature, drying shrinkage, materials creep, etc. Applicable gauge length should be three times as large as the diameter of the aggregate so as to give an averaged evaluation of the concrete.

As illustrated right, the KM end is wired between reinforcing bars, then position the KM to marked points of reinforcing bar in advance.

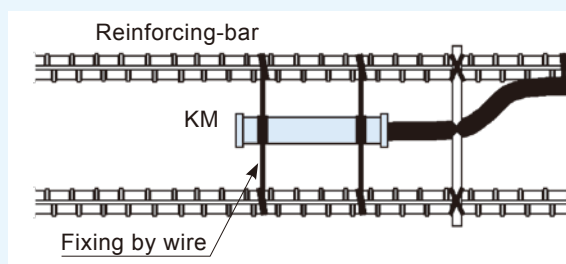

Civil Engineering use series **KM/ KM-HAS** STRAIN TRANSDUCERS

Operating temperature range
 -20°C  +180°C

For surface strain measurement

Surface strain measurement onto steel and concrete structures is available with KM-100B or KM-100BT. (Optional fittings such as Spacer and Collar are available for fixing the model and positioning gauge length).

An installation onto the surface of steel structure



The KM model is combined with optional Collar KMF-22-100 to install onto the surface of steel by welding.

An installation onto the surface of concrete structure

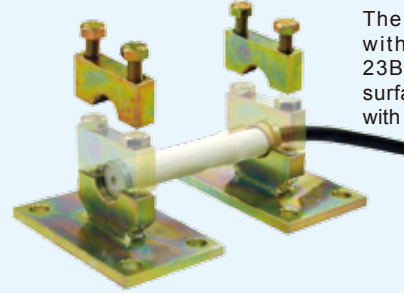

The KM model is combined with optional Collar KMF-23B-100 to install onto the surface of concrete structure with anchor bolts.

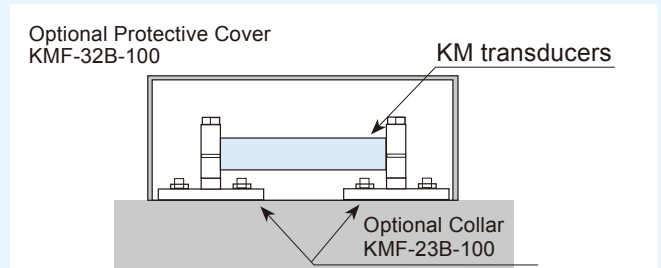
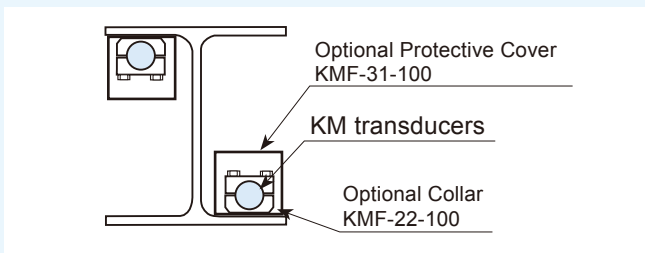

STRAIN TRANSDUCER KM-HAS for asphalt pavement

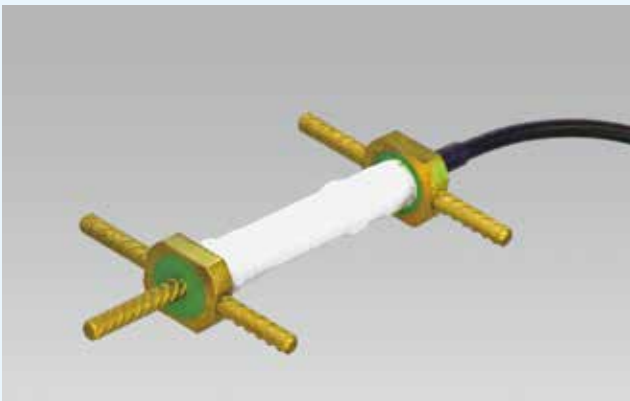

These transducers are embedded into asphalt for measurement of internal strain. They have reinforcing bar flanges at its both ends for good fixation to asphalt pavement materials. The operating temperature range of the transducer is -20 to +180°C, and they have fully waterproof construction.

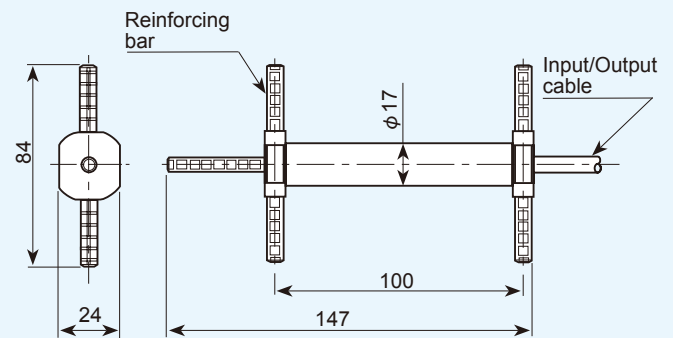

■ SPECIFICATIONS

Type	KM-100HAS
Capacity	$\pm 5000 \times 10^{-6}$ strain
Gauge length	100mm
Rated output	Approx. 2.5mV/V (5000×10^{-6} strain)
Non-linearity	1%RO
Apparent elastic modulus	Approx. 40N/mm ²
Integral temperature	350Ω Full bridge : strain measurement Quarter bridge 3-wire method : temperature measurement
Temperature range	-20~+180°C
Bridge excitation	Recommended 1~2V, Allowable 10V
Input/Output cable	φ 6mm 0.3mm ² 5-core shielded Fluoroplastic cable, 2m

COMPOSITE USE STRAIN GAUGES series UBF

Operating temperature range



Static measurement : -30 ~ +120°C

Dynamic measurement : -30 ~ +150°C

These strain gauges are not self-temperature-compensated. These may be necessary to measure the thermal output using a dummy specimen prior to the measurement.



Applicable adhesives	CN	-20 ~ +120°C
	EB-2	-30 ~ +150°C

COMPOSITE MATERIALS USE

Gauge pattern	Basic type	Gauge size		Backing		Resistance Ω
		L	W	L	W	
<p>These are foil strain gauges developed for measurement on composite materials. They have a specially designed grid pattern to reduce the stiffening effect of the strain gauges. In addition, owing to the development of gauge backing with better compliance, the number of repetition in thermal cycling test and the creep characteristics have been significantly improved compared to conventional strain gauges.</p> <p>Single element</p> UBFLA-03 (x 3) UBFLA-1 (x 3)	<p>Example of type number designation</p> <p>UBFLA-1 -3LJB -F</p> <ul style="list-style-type: none"> Basic strain gauge type, gauge length Length in meter and type of integration leadwire Option F : LEAD-free soldering of leadwire 	Each package contains 10 gauges.				
	UBFLA-03	0.3	1.9	3.4	2.5	120
	UBFLA-1	1	1.3	4.5	2	120

Point

Composite materials consisting of plastic matrix and fibers such as glass fibers (GFRP), carbon fibers (CFRP) or aramid fibers (AFRP) have different elastic modulus and linear thermal expansion coefficient depending on their fiber orientation. For strain measurement, materials property and fiber orientation should be taken into consideration.

COMPOSITE USE STRAIN GAUGES series BF

Operating temperature range



Temperature compensation range



Suffix code for temperature compensation materials
-3, -5 or -8 : composite materials



For ordering, the above suffix code should be added to the basic gauge type.

Applicable adhesives	CN	-20 ~ +120°C
	NP-50B	-20 ~ +200°C
	EB-2	-30 ~ +150°C

COMPOSITE MATERIALS USE

Gauge pattern	Basic type	Gauge size		Backing		Resistance Ω	
		L	W	L	W		
<p>These are foil strain gauges designed for measurement on composite materials. They have a specially designed grid pattern to enable small stiffening effect and excellent performance in strain measurement up to 200°C. This series is available with self-temperature-compensation for a material having coefficient of thermal expansion of 3,5 or 8×10⁻⁶/°C. This series is recommended for use on ceramic, carbon and composite materials.</p> <p>Single element</p> BFLA-2 Single element	<p>Example of type number designation</p> <p>BFLA-2 -3 -3LJC -F</p> <ul style="list-style-type: none"> Basic strain gauge type, gauge length Self-temperature-compensation number Length in meter and type of leadwire Option F : LEAD-free soldering of leadwire 	Each package contains 10 gauges.					
	BFLA-2	2	0.9	7.6	2.5	120	
	BFLA-5	5	1.5	12.3	3.3	120	
<p>0°/90° 2-element plane Rosette</p> BFCA-2-3	<p>0°/90° 2-element plane Rosette</p>	BFCA-2	2	1.3	8	8	120
		BFCA-5	5	1.5	11.5	11.5	120
<p>0°/45°/90° 3-element plane Rosette</p> BFRA-2-3	<p>0°/45°/90° 3-element plane Rosette</p>	BFRA-2	2	1.3	8	8	120
		BFRA-5	5	1.5	11.5	11.5	120

Point

Composite materials consisting of plastic matrix and fibers such as glass fibers (GFRP), carbon fibers (CFRP) or aramid fibers (AFRP) have different elastic modulus and linear thermal expansion coefficient depending on their fiber orientation. For strain measurement, consideration of materials property and fiber orientation should be taken.

LOW ELASTIC MODULUS STRAIN GAUGES series GF

Operating temperature range
 -20°C +80°C
 Temperature compensation range
 +10°C +80°C

Suffix code for temperature compensation materials
 -50, or -70 : Plastics



For ordering, the above suffix code should be added to the basic gauge type.

Applicable adhesives

CN	-20 ~ +80°C
----	-------------

PLASTICS USE

Gauge pattern	Basic type	Gauge size		Backing		Resistance Ω																																																																																																												
		L	W	L	W																																																																																																													
<p>These gauges are suited for the measurement on materials such as plastics, which have low elastic modulus compared to metal. These specially designed grid reduces the stiffening effect of the strain gauges to the specimen material, and also reduces the effect of Joule heat in the strain gauges. This series is available with self-temperature-compensation for the material having a coefficient of thermal expansion of 50 or $70 \times 10^{-6}/^{\circ}\text{C}$.</p> <p>Single element</p> GFLA-3 Single element	<div style="border: 1px solid black; padding: 5px; margin-bottom: 10px;"> Example of type number designation GFLA-3 -350 -50 -3LJC ↑ ↑ ↑ ↑ Basic strain gauge type, gauge length Gauge resistance (Blank for 120Ω) Self-temperature-compensation number Length in meter and type of leadwire </div> <p style="text-align: center;">Each package contains 10 gauges.</p> <table border="1" style="width: 100%; border-collapse: collapse;"> <tr><td>GFLA-3</td><td>3</td><td>2.3</td><td>9.5</td><td>4</td><td>120</td></tr> <tr><td>GFLA-6</td><td>6</td><td>2.5</td><td>14</td><td>5</td><td>120</td></tr> <tr><td>GFLA-3-350</td><td>3</td><td>2.9</td><td>10</td><td>5</td><td>350</td></tr> <tr><td>GFLA-6-350</td><td>6</td><td>2.7</td><td>15</td><td>5</td><td>350</td></tr> <tr><td>GFLA-3-350</td><td>3</td><td>2.9</td><td>10</td><td>5</td><td>350</td></tr> <tr><td>GFLA-6-350</td><td>6</td><td>2.7</td><td>15</td><td>5</td><td>350</td></tr> <tr><td>GFLA-3</td><td>3</td><td>2.3</td><td>9.5</td><td>4</td><td>120</td></tr> <tr><td>GFLA-6</td><td>6</td><td>2.5</td><td>14</td><td>5</td><td>120</td></tr> <tr><td>GFLA-3-350</td><td>3</td><td>2.9</td><td>10</td><td>5</td><td>350</td></tr> <tr><td>GFLA-6-350</td><td>6</td><td>2.7</td><td>15</td><td>5</td><td>350</td></tr> <tr><td>GFLA-3</td><td>3</td><td>2.3</td><td>9.5</td><td>4</td><td>120</td></tr> <tr><td>GFLA-6</td><td>6</td><td>2.5</td><td>14</td><td>5</td><td>120</td></tr> <tr><td>GFLA-3-350</td><td>3</td><td>2.9</td><td>10</td><td>5</td><td>350</td></tr> <tr><td>GFLA-6-350</td><td>6</td><td>2.7</td><td>15</td><td>5</td><td>350</td></tr> <tr><td>GFLA-3</td><td>3</td><td>2.3</td><td>9.5</td><td>4</td><td>120</td></tr> <tr><td>GFLA-6</td><td>6</td><td>2.5</td><td>14</td><td>5</td><td>120</td></tr> <tr><td>GFLA-3-350</td><td>3</td><td>2.9</td><td>10</td><td>5</td><td>350</td></tr> <tr><td>GFLA-6-350</td><td>6</td><td>2.7</td><td>15</td><td>5</td><td>350</td></tr> </table>						GFLA-3	3	2.3	9.5	4	120	GFLA-6	6	2.5	14	5	120	GFLA-3-350	3	2.9	10	5	350	GFLA-6-350	6	2.7	15	5	350	GFLA-3-350	3	2.9	10	5	350	GFLA-6-350	6	2.7	15	5	350	GFLA-3	3	2.3	9.5	4	120	GFLA-6	6	2.5	14	5	120	GFLA-3-350	3	2.9	10	5	350	GFLA-6-350	6	2.7	15	5	350	GFLA-3	3	2.3	9.5	4	120	GFLA-6	6	2.5	14	5	120	GFLA-3-350	3	2.9	10	5	350	GFLA-6-350	6	2.7	15	5	350	GFLA-3	3	2.3	9.5	4	120	GFLA-6	6	2.5	14	5	120	GFLA-3-350	3	2.9	10	5	350	GFLA-6-350	6	2.7	15	5	350
GFLA-3							3	2.3	9.5	4	120																																																																																																							
GFLA-6	6	2.5	14	5	120																																																																																																													
GFLA-3-350	3	2.9	10	5	350																																																																																																													
GFLA-6-350	6	2.7	15	5	350																																																																																																													
GFLA-3-350	3	2.9	10	5	350																																																																																																													
GFLA-6-350	6	2.7	15	5	350																																																																																																													
GFLA-3	3	2.3	9.5	4	120																																																																																																													
GFLA-6	6	2.5	14	5	120																																																																																																													
GFLA-3-350	3	2.9	10	5	350																																																																																																													
GFLA-6-350	6	2.7	15	5	350																																																																																																													
GFLA-3	3	2.3	9.5	4	120																																																																																																													
GFLA-6	6	2.5	14	5	120																																																																																																													
GFLA-3-350	3	2.9	10	5	350																																																																																																													
GFLA-6-350	6	2.7	15	5	350																																																																																																													
GFLA-3	3	2.3	9.5	4	120																																																																																																													
GFLA-6	6	2.5	14	5	120																																																																																																													
GFLA-3-350	3	2.9	10	5	350																																																																																																													
GFLA-6-350	6	2.7	15	5	350																																																																																																													
<p>0°/90° 2-element plane Rosette</p> GFCA-3 0°/90° 2-element plane Rosette																																																																																																																		
<p>0°/45°/90° 3-element plane Rosette</p> GFRA-3 0°/45°/90° 3-element plane Rosette																																																																																																																		

Point

■ Effect of low elastic modulus of specimen

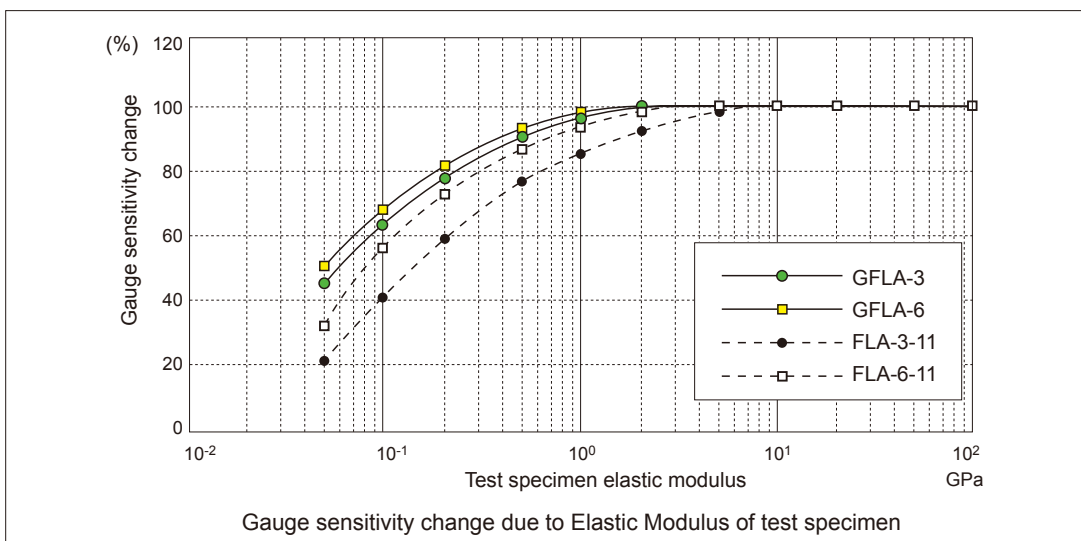

When a strain gauge is installed on materials such as plastics that have low elastic modulus, the stiffness of the strain gauge causes to disturb the stress distribution around the strain gauge, thus resulting in reduced strain sensitivity. This is referred to as the strain gauge stiffening effect and it gets larger as the elastic modulus of specimen gets smaller. For materials with an elastic modulus of 2.9GPa (approx. 300kgf/mm²) or less, a preparatory test must be conducted to correct the gauge factor.



■ Effect of Joule heat

The GF series gauges have a specially designed grid to reduce the effect of Joule heat. Though an allowable current is 30mA or less for metallic specimens in general, a current of 10mA or less is recommended for plastic specimen.

LOW ELASTIC STRAIN GAUGES series LF

Operating temperature range
 -20°C  +80°C
 Temperature compensation range
 +10°C  +80°C

Suffix code for temperature compensation materials
 -11: Wood, Gypsum 



Applicable adhesives



CN-E	-20 ~ +80°C
------	-------------

For ordering, the above suffix code should be added to the basic gauge type.

WOOD, GYPSUM USE

Gauge pattern	Basic type	Gauge size		Backing		Resistance Ω	
		L	W	L	W		
<p>These are foil strain gauges for the measurement on materials having low elastic modulus such as wood or gypsum. These specially designed grid reduces the stiffening effect of the strain gauges to the specimen material. They have a backing made of epoxy resin. These gauges are temperature-compensated for the material having a coefficient of thermal expansion of $11 \times 10^{-6}/^{\circ}\text{C}$.</p> 	<p>Example of type number designation</p> <p>LFLA-10 -11 -3LJC</p> <p>↑ ↑ ↑ Basic strain gauge type, gauge length Length in meter and type of leadwire Self-temperature compensation number</p>	Single element	Each package contains 10 gauges.				
	LFLA-10-11	10	3.1	18.5	5.3	120	

WOODEN MATERIAL USE FOR LONG TERM STRAIN GAUGES Series PFLW/PLW

Operating temperature range
 -20°C  +80°C
 Temperature compensation range
 +10°C  +80°C



Suffix code for temperature compensation materials
 -11: Wood



Applicable adhesives

PS	-20 ~ +80°C
----	-------------

WOOD USE

Gauge pattern	Basic type	Gauge size		Backing		Resistance Ω
		L	W	L	W	
<p>These gauges are specially designed for long term measurement on wood. They have a metal foil lined on the back of the PFL or PL strain gauges. The metal foil is effective to protect the strain gauges from an influence of moisture in the wood. These gauges should be bonded with PS adhesive to make the best of their performance.</p>	<p>Example of type number designation</p> <p>PFLW-30 -11 -3LJC</p> <p>↑ ↑ ↑ Basic strain gauge type, gauge length Length in meter and type of leadwire Self-temperature compensation number</p>	L : length W : width (Unit:mm)				
<p>Single element</p>  <p>PFLW-30-11</p>  <p>PLW-60-11</p>	Single element	Each package contains 10 gauges.				
	PFLW-30-11	30	2.3	40	7	120
	PLW-60-11	60	1	74	8	120

The PFLW and PLW series are available with 1, 3 or 5m long in 2-wire parallel or 3-wire parallel vinyl leadwires.

Recommendable integral leadwire for PFLW/PLW series

Application	Leadwires	Operating temperature (°C)	Leadwire code exemplified
General use (temperature unchanged during measurement)	Paralleled vinyl -LJB -LJC	-20~ +80	PFLW-30-11-3LJB/PLW-60-11-3LJB PFLW-30-11-3LJC/PLW-60-11-3LJC
General use	3-wire paralleled vinyl -LJBT -LJCT	-20~ +80	PFLW-30-11-3LJBT/PLW-60-11-3LJBT PFLW-30-11-3LJCT/PLW-60-11-3LJCT
1-gauge 4-wire measurement	0.08mm ² polypropylene 4-wire paralleled -LQM	-20~ +100	PFLW-30-11-3LQM/PLW-60-11-3LQM

MAGNETIC FIELD series MF STRAIN GAUGES

Applicable adhesives for single element

CN/CN-E	-20 ~ +80°C
RP-2	-20 ~ +80°C

Suffix code for temperature compensation materials
 -11: Mild steel ■ -17: Stainless steel ■ -23: Aluminium ■

Applicable adhesives for 2-/3-element Stacked Rosette

CN/CN-E	-20 ~ +120°C
NP-50B/EB-2/C-1	-20 ~ +200°C

For ordering, the above suffix code should be added to the basic gauge type.

MAGNETIC FIELD USE

Gauge pattern	Basic type	Gauge size		Backing		Resistance Ω
		L	W	L	W	

These gauges are designed for strain measurement in magnetic field. The gauges have a sensing element material which exhibits low magnetoresistance. In addition, the sensing element consists of two identical grids with one grid folded back on another. This construction makes the strain gauges less sensitive to the influence of the alternating field. The gauges have a twisted leadwire pre-attached which is also effective to avoid the influence of the alternating field. The 2-element and 3-element rosette gauges of this series are usable in high temperature up to 200°C.

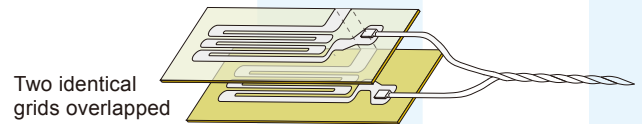

Single element

0.08mm² integral stranded vinyl leadwire of 1m -LJAY
 Total leadwire resistance per meter : 0.44 Ω

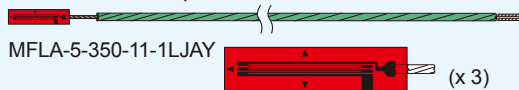

Shielded leadwire

ϕ 3.2mm 2-core shielded stranded vinyl leadwire of 1m
 Total leadwire resistance per meter : 0.44 Ω

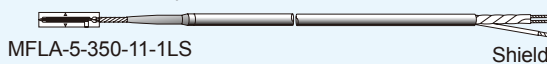

0°/90° 2-element Stacked Rosette

ϕ 1.5mm 0.04mm² 3-wire twisted fluorinated resin insulated leadwire of 1m
 Total leadwire resistance per meter : 1.1 Ω

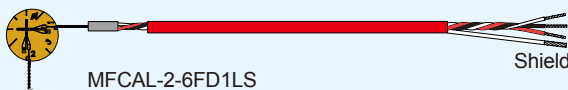

0°/45°/90° 3-element Stacked Rosette

ϕ 1.5mm 0.04mm² 3-wire twisted fluorinated resin insulated leadwire of 1m
 Total leadwire resistance per meter : 1.1 Ω

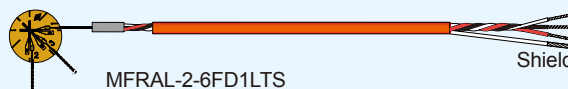

Single element

Operating temperature range -20°C +80°C

Single element	Minimum order is 10 gauges or more.				
MFLA-2-350-11	2	0.5	4.7	1.9	350
MFLA-5-350-11	5	0.5	7.9	1.9	350

Integral leadwire lengths longer than 1m are available for single element gauges. For 2-element and 3-element rosette gauges, no other length than 1m is available.

2-element Rosette/3-element Rosette

Operating temperature range

-20°C +200°C

Minimum order is 10 gauges or more.

0°/90° 2-element Stacked Rosette					
MFCAL-2-6FD-1LTS	2	0.1	ϕ 7		120
MFCAL-2-350-6FD1LTS	2	0.2	ϕ 7		350

0°/45°/90° 3-element Stacked Rosette					
MFRAL-2-6FD-1LTS	2	0.1	ϕ 7		120
MFRAL-2-350-6FD1LTS	2	0.2	ϕ 7		350

Concrete structure use

Temperature-compensation is not available.

0.08mm² integral stranded vinyl leadwire of 1m
 Total leadwire resistance per meter : 0.44 Ω

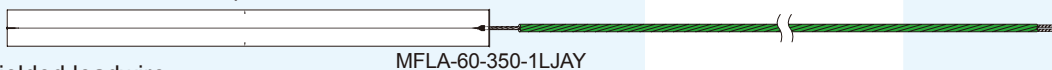

Shielded leadwire

ϕ 3.2mm 2-core shielded stranded vinyl leadwire of 1m
 Total leadwire resistance per meter : 0.44 Ω

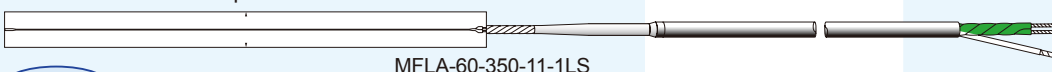

Single element

Operating temperature range -20°C +80°C
 Minimum order is 10 gauges or more.

MFLA-60-350	60	0.1	64	5	350
-------------	----	-----	----	---	-----

Point

Countermeasure against Noise interference in magnetic field

If you are not using magnetic field strain gauge, use a strain gauge with a narrow gauge width. A narrow gauge width reduces the induced voltage on the gauge leads and is preferable to a wide strain gauge.

The parallel leadwires used in normal strain measurement are affected by induction. Always use twisted wires. The intertwining of twisted wires cancels out the induced voltage that is generated. Using shielded leadwires also prevents interference from noise.

Connection

If you extend the leadwires, locate the connection as far as possible from the magnetic field. Bridge boxes should also be placed as far as possible from the magnetic field. If you do connect the wires inside the magnetic field, keep the length of the connecting wire (A) short and the distance between the leads (B) small.

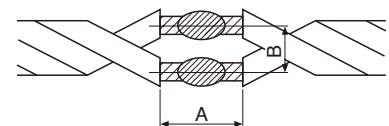

POST-YIELD (Large strain) MEASUREMENT STRAIN GAUGES series YEF/YF/YHF

Self-temperature-compensation : Not available



LARGE STRAIN MEASUREMENT

Gauge pattern	Basic type	Gauge size		Backing		Resist-ance Ω
		L	W	L	W	

series YEF

These gauges are applicable to the measurement of large strain up to 10~15%. Also these withstand the repeated strain in elastic range (at strain level $\pm 1500 \times 10^{-6}$ strain) like ordinary strain gauges. However, these are not applicable to the measurement of repeated strain in a large range.

Option F

This code is appended to the basic type for strain gauges with lead-free solder in place of leaded solder. Fatigue life of the strain gauge may become shorter by the lead-free solder.

Single element



0°/90° 2-element plane Rosette

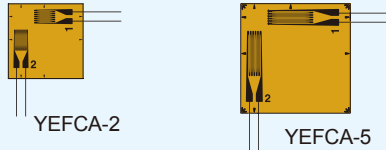

0°/45°/90° 3-element plane Rosette

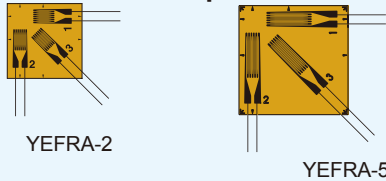

Operating temperature range



Applicable adhesives

CN	-20 ~ +80°C
CN-Y	-20 ~ +80°C

Strain limit in room-temperature

10 ~ 15%

Example of type number designation

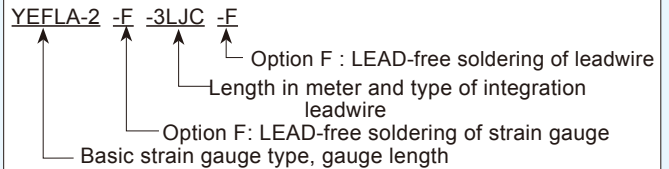

Each package contains 10 gauges.

Single element	YEFLA-2	2	1.8	7.5	4	120
	YEFLA-5	5	1.9	12	4	120
0°/90° 2-element Rosette	YEFCA-2	2	1.8	10	10	120
	YEFCA-5	5	2	14.5	14.5	120
0°/45°/90° 3-element Rosette	YEFRA-2	2	1.8	10	10	120
	YEFRA-5	5	2	14.5	14.5	120

Operating temperature range



Applicable adhesives

CN	-20 ~ +80°C
CN-Y	-20 ~ +80°C

Strain limit in room-temperature

15 ~ 20%

Example of type number designation

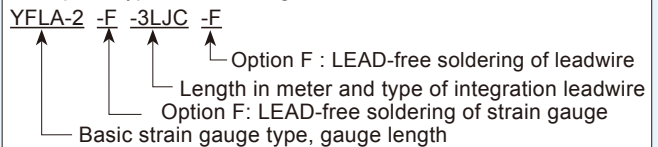

Each package contains 10 gauges.

Single element	YFLA-2	2	1.8	7.5	4	120
	YFLA-5	5	1.9	12	4	120
	YFLA-10	10	2.6	16.6	4.9	120
	YFLA-20	20	1.8	26	3.7	120

series YF

These gauges are applicable to the measurement of large strain up to 15 to 20%. These are not applicable to the measurement of repeated strain in elastic range as well as in large range.

Option F

This code is appended to the basic type for strain gauges with lead-free solder in place of leaded solder. Fatigue life of the strain gauge may become shorter by the lead-free solder.

Single element

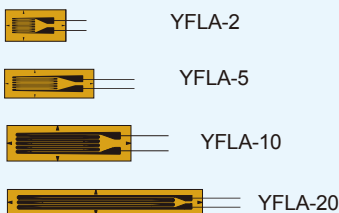

POST-YIELD (Large strain) MEASUREMENT STRAIN GAUGES series YEF/YF/YHF

LARGE STRAIN MEASUREMENT

Gauge pattern	Basic type	Gauge size L W	Backing L W	Resist- ance Ω
---------------	------------	-------------------	----------------	-------------------

series YHF

These gauges are developed for the measurement of very large strain up to 30~40%. These are not applicable to the measurement of repeated strain in elastic range as well as in large range.

Option F

This code is appended to the basic type for strain gauges with lead-free solder in place of leaded solder. Fatigue life of the strain gauge may become shorter by the lead-free solder.

Operating temperature range
 -30°C +80°C

Applicable adhesives	CN	-30 ~ +80°C
	CN-Y	-30 ~ +80°C

Strain limit in room-temperature	30 ~ 40%
----------------------------------	----------

Example of type number designation

YHFLA-2 -F -3LJC -F

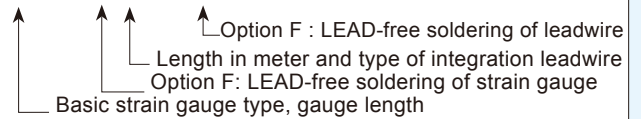

Single element

= YHFLA-2

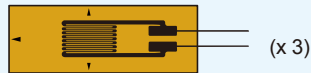

= YHFLA-5

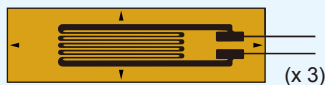

Each package contains 10 gauges.

YHFLA-2	2	1.5	8	2.7	120
YHFLA-5	5	1.7	11	3	120

Recommendable integral leadwire for YEF/YF/YHF series

Application	Leadwires	Operating temperature (°C)	Leadwire code exemplified
General use (temperature unchanged during measurement)	Paralleled vinyl LJC-F	-20~ +80	YEFLA-2-3LJC-F YFLA-2-3LJC-F
		-30~ +80	YHFLA-2-3LJC-F
General use	3-wire paralleled vinyl LJCT-F	-20~ +80	YEFLA-2-3LJCT-F YFLA-2-3LJCT-F
		-30~ +80	YHFLA-2-3LJCT-F

Point
Performance of YEF/YF/YHF

Series	Strain measurement	Fatigue limit at room temperature* ¹	Self-temperature compensation	Change of apparent strain due to cyclic loading of large strains* ²	Applications
YEF	10~15%	5 x 10 ⁵ cycles	Not available	2000 x 10 ⁻⁶ strain/10 cycles	Measurement of repeated strain in elastic range.
YF	15~20%	1 x 10 ² cycles	Not available	2000 x 10 ⁻⁶ strain/10 cycles	
YHF	30~40%	2 x 10 ⁴ cycles	Not available	Not available	
F	5%	1 x 10 ⁶ cycles	Effective	400 x 10 ⁻⁶ strain/10 cycles	Measurement of repeated strain in elastic range.

*¹: The number of repetitions at which the indicated strain value changes by 100x10⁻⁶ strain or more by applying repeated strain of approx. ±1,500x10⁻⁶ strain at 15Hz

*²: Change of indicated strain by applying a repeated strain of approx. ±10,000x10⁻⁶ strain at a speed of 4 minutes per cycle.

Adhesive for YEF/YF/YHF series gauges

These strain gauges should be bonded with CN or CN-Y adhesive. If measurement is made a few days or longer after the strain gauge bonding, the CN-Y should be used. Measurement of large strain is possible even after one year of bonding the strain gauge with the CN-Y adhesive, provided that the specimens are stored at room temperature without any unfavorable conditions (moisture, direct sunlight, etc.).

CN adhesive variation with time

Though CN adhesive is normally used for large elongation strain measurement, the strain limit gradually decreases with the number of days following strain gauge installation. This variation with time occurs as a consequence of exposure to direct sunlight (UV), temperature and humidity, as well as the number of days since installation. The following shows an example of the results of testing performed by TML for the effects of adhesive variation with time. While these results show marked differences due to the exposure conditions of the test specimens (temperature and humidity), they also show that the strain limits for strain gauges decrease as time passes after installation. While this does not pose a problem in ordinary strain measurement, TML recommends that the measurement ends in 1 or 2 days after installation in the case of large elongation strain measurement. If the strain gauge is to be left for a long period after being installed, use the CN-Y adhesive.

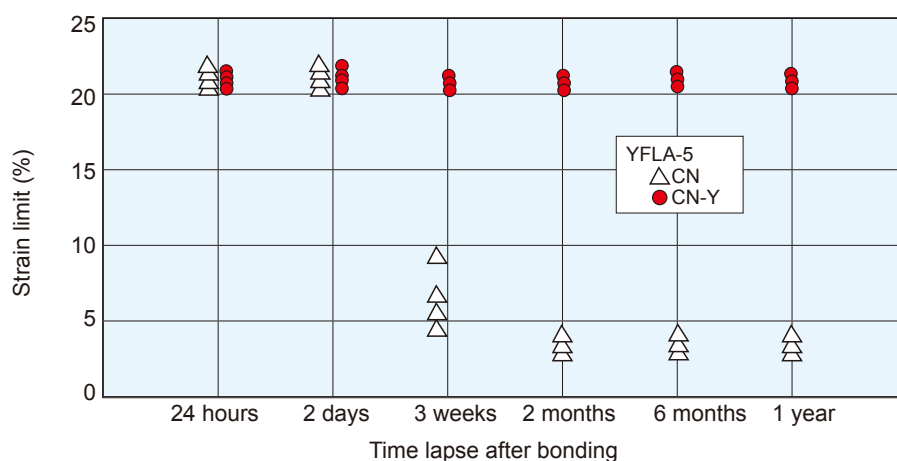
Countermeasure in case there is a span between gauge installation and start of measurement

Store the test specimen with the attached strain gauge in a cool, dark and dry location.
Use the CN-Y adhesive. (Refer to the instructions provided).

Repeatability of Post-Yield strain gauges

Post-Yield strain gauges can be used once to measure large elongation strain, but cannot be used for measurement of repeated large elongation strain. When repeated testing is performed in a strain range exceeding 5000x 10⁻⁶, the strain gauge experiences zero drift. Note that the amount of drift varies depending on factors such as the type of strain gauges and the level and frequency of strain.

HIGH ENDURANCE series DSF STRAIN GAUGES

Operating temperature range



These strain gauges are not self-temperature-compensated. It may be necessary to measure a thermal output using a dummy specimen prior to the measurement.



Applicable adhesives

CN	-60 ~ +120°C
C-1	-60 ~ +200°C
EB-2	-60 ~ +200°C

HIGH STRESS FATIGUE TEST

Gauge pattern

These gauges are designed for fatigue test at high stress level. The gauges satisfy the fatigue life over 10 million times at a strain level of $\pm 3000 \times 10^{-6}$. It is available for use in cyclic loading test of composite materials.

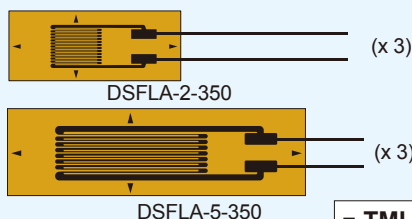

Example of type number designation

DSFLA-2 -350 -3LJB -F

- DSFLA-2: Basic strain gauge type and gauge length
- 350: Gauge resistance
- 3LJB: Length in meter and type of leadwire
- F: Option F: LEAD-free soldering of leadwire CE compliant

Each package contains 10 gauges.

DSFLA-2-350	2	2	8	3.3	350
DSFLA-5-350	5	2	11	3.2	350

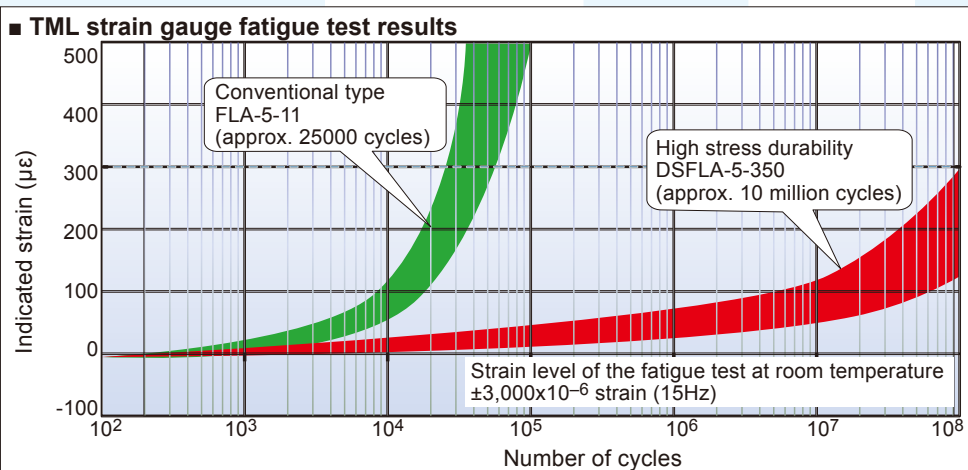

Fatigue Limit

This number is determined as the number of cycles in case a mechanically repeated strain of $\pm 3000 \times 10^{-6}$ strain is applied to the strain gauge before the indicated strain changes by $\pm 300 \times 10^{-6}$ strain.

ONE-SIDE STRAIN GAUGES series DD

Operating temperature range



These strain gauges are not self-temperature-compensated. It may be necessary to measure a thermal output using a dummy specimen prior to the measurement.



Applicable adhesives

CN	-10 ~ +70°C
P-2	-10 ~ +70°C

ONE-SIDE STRAIN GAUGES

Gauge pattern

Thickness of applicable specimen (mm)

Basic type

Gauge size L W

Backing a b c

Resist-ance Ω

These gauges are intended for measuring the bending and tensile strains separately by simply bonding the gauges on one side of a plate or beam. It works on the assumption that the strain distribution in the section of the specimen is linear along the height of the section when the section is subjected to both tensile and bending stress. The gauges are effectively used for the measurement of a box construction in structures such as bridges or pressure vessels, where the reverse side of the measurement object is not accessible for strain gauge installation.

Example of type number designation

DD-1-15 -350 -3LJB

- DD-1-15: Basic strain gauge type
- 350: Gauge resistance
- 3LJB: Length in meter and type of leadwire

Each package contains 5 gauges.

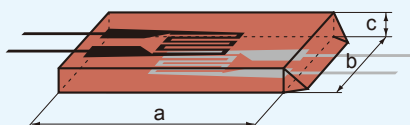

Approx. 5 or less	DD-1-15	3	2.9	15	7	1	350
Approx. 5~10	DD-2-30			30	7	2	

CRACK DETECTION GAUGES series FAC

Operating temperature range

-30°C  +80°C



Applicable adhesives

CN	-30 ~ +80°C
RP-2	-30 ~ +80°C

CRACK PROPAGATION MEASUREMENTS

These gauges are designed to measure the propagation speed of fatigue crack in a metal specimen. The gauges are bonded with an adhesive on the position where the crack is initiated or the crack initiation is expected. The grids of the gauges, which are aligned at interval of 0.1mm or 0.5mm, are disconnected one by one with the propagation of the crack. The gauges are used together with the crack gauge adaptor CGA-120B, and the disconnection of one grid is measured as the change of approx. 45 or 40×10⁻⁶ strain by a strainmeter.



CRACK GAUGES

Gauge type	FAC-5	FAC-20
Measuring range	4.5mm	20mm
Gauge resistance	approx. 1Ω	
Grid interval	0.1mm	0.5mm
Number of grids	46	41
Output per grid	approx. 45 με	approx. 40 με
Operating temperature	-30 ~ +80°C	
Backing size	28 x 5mm	43 x 25mm

Crack Gauge Adaptor CGA-120B

Measuring point	1
Allowable temperature	-30 ~ +80°C
Bridge connection	Quarter bridge 3-wire method 120Ω
Dimension	20(W) x 15(H) x 15(D) mm (except projection parts)
Weight	5g

Gauge pattern

Crack Gauges

FAC-5



Each package contains 10 gauges.

FAC-20

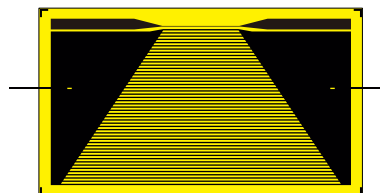

Minimum order is 1 piece or more.

Crack Gauge Adaptor CGA-120B

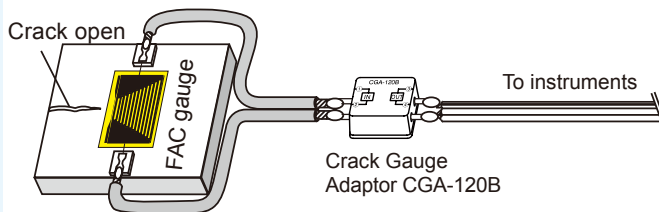

STRESS GAUGES series SF

Operating temperature range

-20°C  +200°C

Temperature compensation range

+10°C  +100°C



Applicable adhesives

NP-50B	-20 ~ +200°C
C-1	-20 ~ +200°C
CN	-20 ~ +120°C

Suffix code for temperature compensation materials
 -11: Mild steel -17: Stainless steel -23: Aluminium 

For ordering, the above suffix code should be added to the basic gauge type.

AXIAL STRESS MEASUREMENT

Gauge pattern

Poisson's ratio of specimen

Basic type

Gauge size
L W

Backing
L W

Resistance Ω

These gauges are intended to measure the stress in an optional direction of the specimen in plane stress field. The gauges are sensitive not only in these axial direction but also in the transverse direction, and the sensitivity ratio of the transverse direction to the axial directions is equal to the Poisson's ratio of the specimen material. In addition, the gauges are not sensitive to the shearing strain. Accordingly, the output of the gauges is proportional to the stress in the axial direction. The gauges are available in three types depending on the Poisson's ratio of the specimen material.

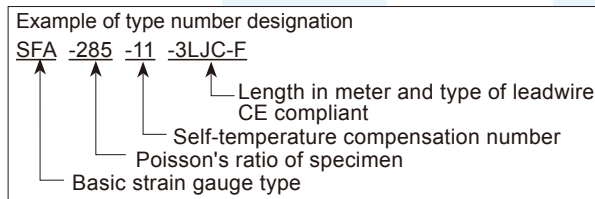

SFA-285

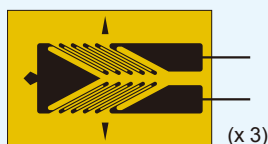

(x 3)

Each package contains 10 gauges.

0.285	SFA-285-11					
0.305	SFA-305-17	4	3	9	6	120
0.330	SFA-330-23					

TEMPERATURE GAUGES series TF

Operating temperature range



Applicable adhesives

NP-50B	-20 ~ +200°C
C-1	-20 ~ +200°C
CN	-20 ~ +120°C

TEMPERATURE GAUGES

Gauge pattern	Basic type	Gauge size		Backing		Resistance Ω	
		L	W	L	W		
<p>These gauges are bonded on the specimen surface like ordinary strain gauges, and measures the surface temperature. By combining with the dedicated temperature gauge adaptor (TGA-1A or TGA-1B), actual temperature can be measured easily using a strainmeter.</p>	TFL-2-60	0.34 approx.	2	1.9	6.1	3.5	60
	TFL-3-60	0.34 approx.	3	3.2	8.5	5	60
	TFL-6-60	0.34 approx.	6	2.6	13	4.5	60
	TFL-8	0.68 approx.	8	3.5	14	5.4	120

TGA-1A/TGA-1B Temperature Gauge Adaptor

This adaptor is used with temperature gauges TF series for direct reading of temperature with a strainmeter, and converts output to 100×10^{-6} strain/°C.

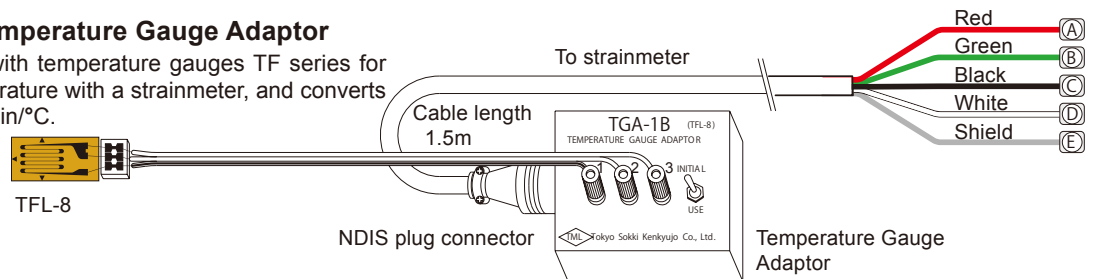

Type of Adaptor	Applicable gauge	Temperature °C	Sensitivity ($\times 10^{-6}$ strain/°C)	Accuracy (°C)	Bridge mode	Dimensions W x H x D(mm)	Weight
TGA-1A	TFL-2-60	-20~+200	100	±1 or less	Full bridge	100 x 40 x 70	370g
	TFL-3-60						
	TFL-6-60						
TGA-1B	TFL-8	-20~+200	100	±1 or less	Full bridge	100 x 40 x 70	370g

PLATINUM RTD



PLATINUM RTD (Pt 100)

The Platinum RTD is mounted on a specimen and connect to a data logger to measure temperature. Easy measurement of temperature by bonding to specimen with strain gauge adhesive. Units equipped with leadwire are also available upon request.

Type	Rated current	Base size (mm)	Resistance	Operating temperature
CRZ-2005	1mA or less	5x2x1.1	100Ω (at 0°C)	-40 ~ +400°C

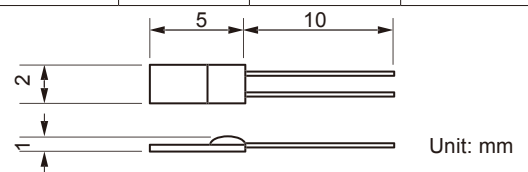

THERMOCOUPLE



A thermocouple configures the closed circuit in which a small electric current flows in the circuit composed of a pair of dissimilar conductors, and measures temperature using

thermoelectric effect produced at both ends of conductors in different temperatures.

Type	Thermo-couple	Core diameter (mm)	Outer dimension (mm)	Sheath materials	Sheath color			Heat-resistive temperature (°C)	Length per roll (m)	Remarks
					Insulator		Outer sheath			
					+	-				
T-G-0.32	T	0.32	2.1x3.2	Heat-resistive vinyl	Red	White	Brown	approx.100	100	
T-G0.65	T	0.65	2.6x4.0	Heat-resistive vinyl	Red	White	Brown	approx.100	100	
T-6F-0.32	T	0.32	1.0x1.6	Fluoroethylene propylene	Red	White	Brown	approx.200	100	
T-6F-0.65	T	0.65	1.5x2.5	Fluoroethylene propylene	Red	White	Brown	approx.200	100	
T-GS-0.65	T	0.65	φ 7.2	Heat-resistive vinyl	Red	White	Brown	approx.100	100	Shielded
K-H-0.32	K	0.32	1.4x2.3	Glass fiber	Red	White	Blue	approx.350	100	
K-H-0.65	K	0.65	2.0x3.4	Glass fiber	Red	White	Blue	approx.350	100	

TRANSDUCER-SPECIFIC STRAIN GAUGES

TML strain gauges are used not only for the purpose of knowing strain/stress but also as sensors for strain gauge type transducers. A strain gauge type transducer converts physical quantity such as load, pressure or displacement into mechanical strain on the strain generating body (elastic body), and the mechanical strain is converted into electrical output using strain gauges mounted on the elastic body. We offer various types of transducer-specific strain gauges featuring highly reliable and stable performance.

Force transducers (Load Cells)
 Pressure transducers
 Acceleration transducers
 Displacement transducers
 Torque transducers

VARIOUS TYPE OF TML TRANSDUCER-SPECIFIC STRAIN GAUGES

GAUGE PATTERN AND GAUGE LENGTH

Single, Rectangular 2-element, Torque (Shearing) strain measurement.

Pattern	Gauge length (mm)
Single-element	2, 3
0°/90° 2-element	2, 3, 6
Torque (Shearing strain) use	2

Pattern

Single-element

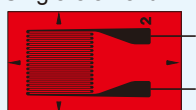

(LA)

Torque

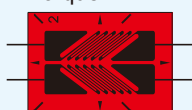

(CT)

0°/90° 2-element

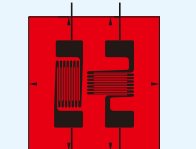

(CB)

0°/90°
2-element

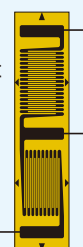

(CM)

2 types of 0°/90° 2-element gauge are lined-up with different pattern of gauge tab. CM-type has half-bridge configuration.

GAUGE RESISTANCE

Pattern	Gauge resistance (Ω)
Single-element	350, 1000
0°/90° 2-element	120, 350
Torque (Shearing strain) use	350

Please note that 1000Ω gauge has less power consumption in bridge circuit comparing to 350Ω gauge's and limits Joule heat generation.

GAUGE BACKING MATERIALS

Unlike stress measurement gauges, the gauge backing materials for transducer-specific strain gauge cannot be determined based solely on the operating temperature and bonding method. To ensure maximum transducer performance, it is necessary to test various combinations using different stress-generating bodies (elastic bodies) to select the most suitable backing materials.

OPERATING TEMPERATURE

Operating temperature range differs from heat-resistive temperature. F series gauge (with epoxy backing) is also available for use of heat-curing type bonding adhesives. Refer to pages 87 and 88 for the details.

Gauge series	Gauge backing materials	Operating temperature
F	Special plastic resin	-20 ~ +150°C
QF	Polyimide resin	-20 ~ +200°C
EF	Polyimide resin	-20 ~ +200°C

TEMPERATURE COMPENSATION

Similarly as general purpose strain gauges, self-temperature-compensated gauges are available in three types for mild steel, stainless steel and aluminium. Better temperature compensation is available by configuring a bridge circuit using self-temperature-compensated strain gauges. More precise temperature compensation is achieved by adding a resistor for zero point compensation in the bridge circuit. Note) EF series gauges are self-temperature-compensated for mild steel only.

Gauge series	Self-temperature-compensation materials (Linear thermal expansion coefficient in ppm/°C)	
F	-11: Mild steel	■
	-17: Stainless steel	■
	-23: Aluminium	■

CREEP ADJUSTMENT

The creep characteristic is particularly important in force transducers. The most common compensation system uses the material creep (+) of the stress-generating body (elastic body) and the gauge creep (-) to cancel each other. Various TML strain gauges are available for creep adjustment and are selectable by creep code.

Creep code

Gauge creep	Large —————> Small
Creep code	C2>C4>C6>C8

TEMPERATURE SENSITIVITY COMPENSATION

Elastic modulus of strain-generating body (elastic body) varies with temperature. In the same manner, as ambient temperature around the strain-generating body varies, it results in a change of measured strain under loaded condition. To reduce such temperature influence, sensitivity compensation resistor is assembled in bridge circuit.

Coding system of Transducer-specific strain gauges

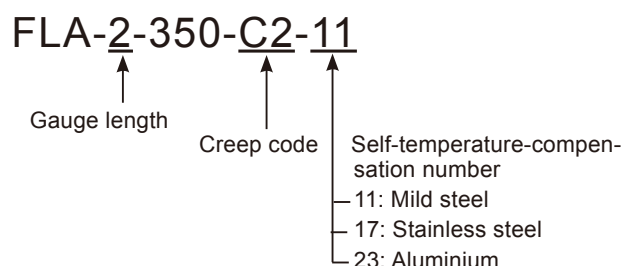

TRANSDUCER-SPECIFIC STRAIN GAUGES

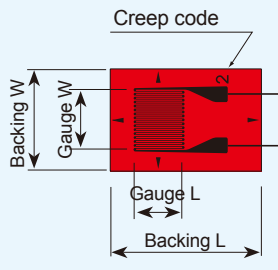
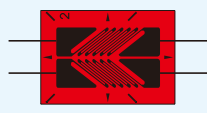
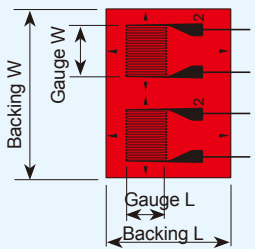
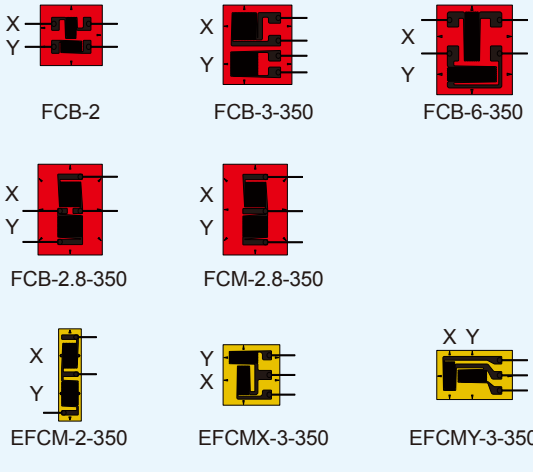
Gauge pattern	Basic type	Gauge size		Backing		Resist-ance Ω			
		L	W	L	W				
<p>•Single element</p>  <p>FLA-2-350-C2</p> <p>Not actual size shown</p>	FLA-2-350-(QF)	C2 C4 C6 C8	2	2.9	6.8	4.6	350		
	FLA-3-350-(QF)	C2 C4 C6 C8	3	3.2	8.5	5	350		
	FLA-3-1000-(QF)	C2 C4 C6 C8	3	4.2	8.4	5.8	1000		
	<p>•Torque (Shearing strain) measurement</p>  <p>FCT-2-350-C2</p> <p>Not actual size shown</p>	FCT-2-350-(QF)	C2 C4 C6 C8	2	1.5	7.6	5.3	350	
		<p>•Single axis 2-element</p>  <p>FLA-2-350-C2-2H</p> <p>Not actual size shown</p>	FLA-2-350-(QF)	C2-2H C4-2H C6-2H C8-2H	2	2.9	6.8	9.2	350
			FLA-3-350-(QF)	C2-2H C4-2H C6-2H C8-2H	3	3.2	8.5	10	350
			<p>•0°/90° 2-element</p> 	FCB (QF)	-2	X and Y axes 2	1.5	8.2	8
		-3-350		X and Y axes 3	3.2	10.5	9.1	350	
		-6-350		X and Y axes 6	2	10	12	350	
		-2.8-350		X and Y axes 2.8	2.8	12	8.5	350	
	FCM-2.8-350	X and Y axes 2.8		2.8	12	8.5	350		
	EFCM-2-350-11	X axis 2.5	1.9	3	12	350			
	Y axis 1.4	3.3							
EFCMX-3-350-11	X and Y axes 3	1.6	8	7.5	350				
EFCMY-3-350-11	X and Y axes 3	1.6	10	6.5	350				

BOLT STRAIN series BTM/BTMC GAUGES

These gauges are used for measurement of tensile strain of bolt. They are simply inserted into pre-drilled hole in the bolt with exclusive adhesives. This method is recommendable when an ordinary strain gauges can not be mounted on the bolt surface. Accurate tensile force measurement is possible by calibrating the bolt after installing the bolt gauges.

Operating temperature range
 -10°C  +80°C
 Temperature compensation range
 Not available

BOLT AXIAL STRAIN MEASUREMENT

Gauge pattern	Basic type	Gauge size		Backing		Resistance Ω
		L	W	L	W	

series BTM



Applicable adhesives

A-2	-10 ~ +80°C
-----	-------------

Each package contains 10 gauges.

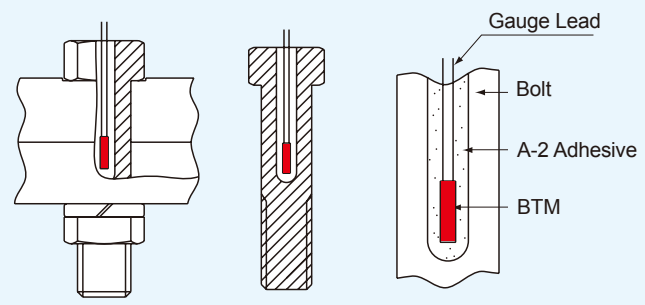

BTM-1C Hole drilled: ϕ 1.6mm	1	0.7	5.6	1.4	120
BTM-6C Hole drilled: ϕ 2.0mm	6	1	12	1.7	120
BTM-6CTA Hole drilled: ϕ 2.0mm	6	1	12	1.7	120

Temperature integrated applicable in -10~+80°C

NB : Polyurethane insulation of the gauge leads is easily removed by heat of soldering iron, while Polyester sheath is removed by chemical solvent.

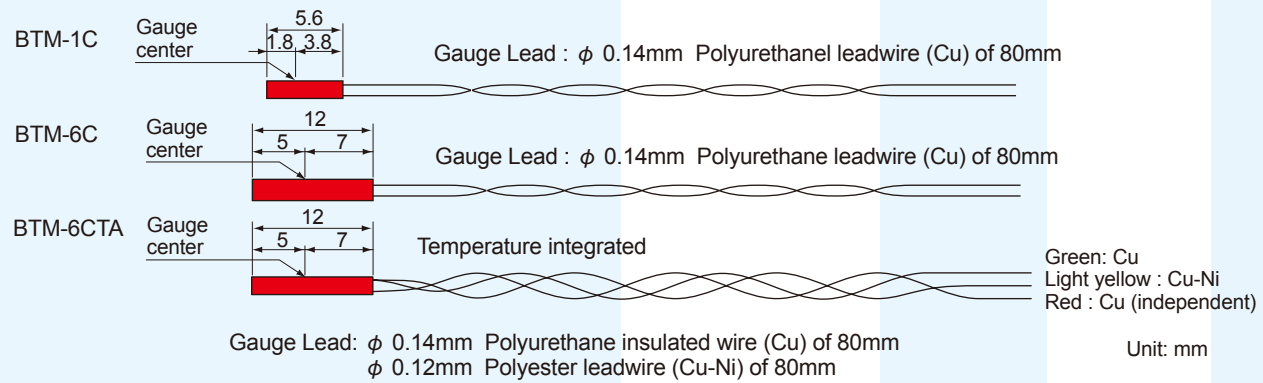

Optional syringe and needle

Applicable to	Needle diameter	Needle length
BTM-1C	1.5mm-dia.	60mm
BTM-6C	1.8mm-dia.	100mm

Exclusive syringe for injecting A-2 adhesive into the pre-drilled hole before BTM-1C or -6C gauge is embedded.

series BTMC



The BTMC gauges have a tube shape sensing element, and they are installed with fast-curing CN adhesive. The installation is easily made at room temperature.

Applicable adhesives

CN	-10 ~ +80°C
----	-------------



Basic type	Gauge Length (mm)	Gauge Center a (mm)	Backing diameter ϕ b (mm)	Resistance Ω
BTMC-05-D10-003LE Hole drilled: ϕ 1.0mm	0.5	5	ϕ 0.9	120
BTMC-1-D16-003LE Hole drilled: ϕ 1.6mm	1	5	ϕ 1.5	120
BTMC-3-D20-006LE Hole drilled: ϕ 2.0mm	3	10	ϕ 1.9	120

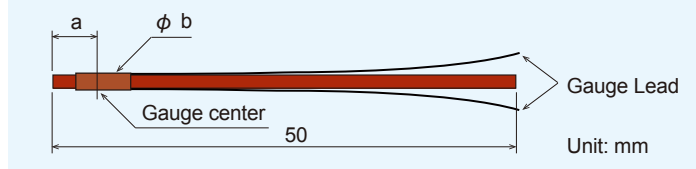

Gauge Lead: ϕ 0.1mm Polyimide insulated of 30mm for BTMC-05 and BTMC-1, 60mm for BTMC-3

Bolt strain gauge installation/calibration service

Currently, bolts are used in various fields for connecting structural members. Confirmation and management of the fixing condition are possible by measuring axial force applied to the bolt in machine structures, cars, airplanes, expressways, bridges, fixing of segments and so on. Also the axial force measurement is useful for knowing the strength of bolt and designing the bolt connection.

TML offers strain gauging service for measurement of axial force acting on bolts. The service includes drilling a hole, fixing the gauge, connecting the cable, and applying load calibration to the bolt supplied by the customer. Strain gauge installation service for high temperature is also available.

Processing method

There are two methods in strain gauge installation service. One is embedding, and the other is bonding.

Embedding BTM/BTMC series

A hole of 1.0mm, 1.6mm or 2mm in diameter is drilled in the center of the bolt. The strain gauge is inserted into the hole and embedded with an exclusive adhesive. This method has the advantage of avoiding the gauge being damaged by a washer, etc. while fastening the bolt.

Bonding F, QF, ZF, CF series

Two strain gauges are bonded on both sides of the bolt shaft in axially symmetric positions to cancel the influence of bending. It is required to slightly scrape off the surface of the bolt shaft where the strain gauges are bonded, for the purpose of avoiding strain gauges being damaged while fastening the bolt or by contact of a washer. Choose strain gauges according to the usage conditions including temperature.



Calibration service

In order to achieve accurate measurement, we offer calibration service that the bolt is calibrated with specified load. Instruments and calibration machines used for the calibration service are periodically calibrated and inspected by public institutions traceable to the national standards.



■ TENSILE TEST OF BOLT

M10×50

No.	Serial No.	Strain output (×10 ⁻⁶)					Non-linearity (%RO)	Calibration coefficient (kN×10 ⁻⁶)	
		0 kN	4 kN	8 kN	12 kN	16 kN			20 kN
1	KNE000001	0	550	1105	1649	2207	2773	0.5	0.007212
2	KNE000002	0	593	1200	1809	2421	3032	0.4	0.006596
3	KNE000003	0	571	1140	1710	2287	2860	0.3	0.006993
4	KNE000004	0	578	1156	1748	2339	2935	0.6	0.006814
5	KNE000005	0	579	1173	1776	2377	2986	0.7	0.006698
		0	554			2239	2806	0	

※ Instrument K=1.000(G.F.=2.00)

Tokyo Sokki Kenkyujo Co., Ltd.
 8-2, Minami-Ohi 6-Chome Shinagawa-ku,
 Tokyo 140-8560 Japan
 TEL(03)3763-5611

Supervised by	Tested by
	
2015.3.1	2015.3.1



CONNECTING TERMINALS

TML Connecting Terminals provide convenient junction points to connect strain gauges to instrumentation leadwires.

T series is made of a cubic plastic and two or three wires of approximately 0.8mm diameter are fixed to the cube. TY is laminated with rubber sheet and suitable for large strain measurement. TP-2 is a self-bonding terminal with two wires. TF is made of a 0.03mm thick copper foil and a glass-epoxy insulation base of approx. 0.15mm thick. TFY is laminated with rubber sheet approx. 0.8mm thick over the back side of TF series terminals.

Cubic shape

for general purpose

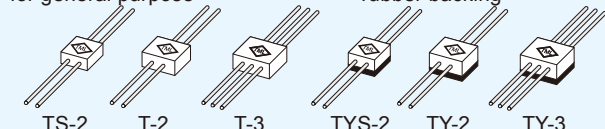

for large strain with rubber backing

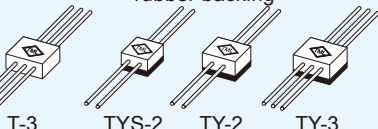

Self-bonding type
(No adhesive required)

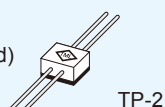

Foil shape

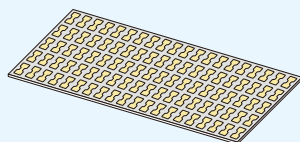

for general purpose



for large strain with rubber backing



High temperature use with polyimide resin backing

TPF-2SS TPF-2S TPF-2MS TPF-2M
TPFH-2SS TPFH-2S TPFH-2MS -



Cubic type

Type	Dimensions (mm)	Operating temperature (°C)	Quantity (pcs/box)
T-2	10x10x5	-20~+90	100
T-3 (3-wire method)	10x10x5	-20~+90	100
TS-2	7.5x7.5x5	-20~+90	100
TYS-2	7.5x7.5x7	-20~+90	100
TY-2	10x10x7	-20~+90	80
TY-3 (3-wire method)	10x10x7	-20~+90	80
TP-2	10x10x6	-20~+60	100

Foil type

Type	Dimensions (mm)	Operating temperature (°C)	Quantity (pairs/sheet)
TF-2SS	4.6x3.8x0.2	-196~+180	50
TF-2S	6 x5.3x0.2	-196~+180	50
TF-2MS	8 x7.2x0.2	-196~+180	50
TF-2M	10x9.2x0.2	-196~+180	50
TFY-2SS	4.6x3.8x0.8	-20~+120	50
TFY-2S	6 x5.3x0.8	-20~+120	50
TFY-2MS	8 x7.2x0.8	-20~+120	50
TFY-2M	10x9.2x0.8	-20~+120	50
TPF-2SS	4.6x3.8x0.2	-196~+200	50
TPF-2S	6 x5.3x0.2	-196~+200	50
TPF-2MS	8 x7.2x0.2	-196~+200	50
TPF-2M	10x9.2x0.2	-196~+200	50
TPFH-2SS	4.6x3.8x0.1	-269~+350	50
TPFH-2S	6 x5.3x0.1	-269~+350	50
TPFH-2MS	8 x7.2x0.1	-269~+350	50

NB: TPFH series are heat-resistive connecting terminals with polyimide resin backing to TPF. It allows high temperature measurement using QF/ZF series gauges and bonding repetition on the terminals.

STRAIN GAUGE CLAMP

Gauge Mate GMR-S/GMA-S

When bonding a strain gauge, a fixing pressure should be applied to the gauge until curing is completed. This can be easily done using TML Gauge Mate, which is a gauge clamp device consisting of a coil spring and a permanent magnet. For use on specimens of different shapes, two types are available. Model GMA-S is for flat specimens, and model GMR-S is for round specimens. Both can be used with room-temperature curing type bonding adhesives.

GMA-S
for flat specimen of 1mm thick or more

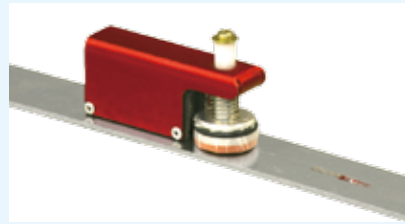

GMR-S
for round specimen of 6~32mm- dia.

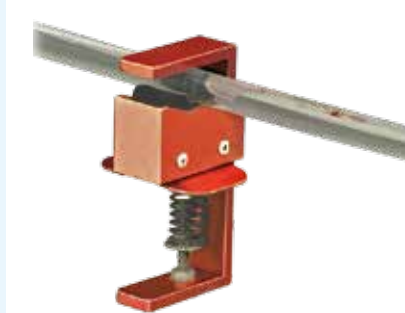

Pressing jig PRESSEE PM-19

PRESSEE is a pressing jig capable of not only pressurizing the strain gauge but also checking adhesion status from the clear pressing part with eyes. The use of PRESSEE saves time to keep pressing the strain gauge with your finger in the bonding work. In addition, since the PRESSEE can apply a constant pressure to the strain gauge, bonding quality is expected to be higher than a finger pressure.

Pressure area of ϕ 19mm for flat specimen.



Applicable strain gauge	Gauge length of 6mm or less and backing dimension of ϕ 15mm or less
Applicable adhesive	CN/CN-R/CN-Y, P-2, NP-50B, EA-2A, EB-2
Pressing method	Magnetic method by permanent magnet
Object to be bonded	Flat surface of magnetic body
Dimensions	ϕ 29mm x Approx. 30mm height

STRAIN GAUGE ADHESIVES



STRAIN GAUGE ADHESIVES

Type		Contents	Component	Applicable specimen	Operating temperature	Curing temperature and time
CN	Single component Room-temperature-curing	Single 2g x 5	Cyanoacrylate	Metal, Plastics Composite	-196~+120°C	Room temperature 20sec.~1 min. (thumb pressure)
CN-E	Single component Room-temperature-curing	Single 2g x 5	Cyanoacrylate	Concrete Mortar, Wood	-30~+120°C	Room temp. 40sec.~2 min. (thumb pressure)
CN-R	Single component Room-temperature-curing	Single 2g x 5	Cyanoacrylate	Metal, Plastics Composite	-30~+120°C	Room temp. 10~30sec. (thumb pressure)
CN-Y	Single component Room-temperature-curing	Single 2g x 5	Cyanoacrylate	Metal, Plastics Composite	-30~+80°C	Room temperature 60 sec.~2 min. (thumb pressure)
P-2	Two-component Room-temperature-curing Mixing ratio: 2~6%	A: 25g * B: 3g *	Polyester	Metal	-30~+180°C	Room temperature Pressure 50~300kPa 2~3 hrs.
RP-2	Two-component Room-temperature-curing Mixing ratio: 2~4%	A: 25g * B: 3g *	Polyester	Concrete Mortar	-30~+180°C	Room temperature Pressure 50~300kPa 2~3 hrs.
PS	Two-component Room-temperature-curing Mixing ratio: 2~4%	A: 25g * B: 3g *	Polyester	Concrete Mortar Wood	-30~+100°C	Room temperature 2~3 hrs.
NP-50B	Two-component Room-temperature-curing Mixing ratio: 3~4%	A: 25g * B: 3g *	Polyester	Metal Composite	-30~+300°C	Room temperature Pressure 50~300kPa 16 hrs.
C-1	Single component Heat-curing	Single 25g *	Phenol	Metal	-269~+200°C	Pre-curing at 130°C 1 hr., pressure 200~300kPa. Post-curing at 200°C 1 hr. without pressure
EA-2A	Two-component Room-temperature-curing Mixing ratio: 2:1	A: 25g * B: 15g *	Epoxy	Metal, Concrete Composite	-269~+50°C	Pressure at 50~300kPa. Room temperature 1 day, or at 50°C 2 hrs.
EB-2	Two-component Room-temperature-curing Mixing ratio: 10:3	A: 10g x3 B: 3g x3	Epoxy	Metal Composite	-60~+200°C	Room temperature 1 day Pressure 50~200kPa.
A-2	Two-component Heat-curing Mixing ratio: 10:1	A: 25g * B: 5g *	Epoxy	Bolt	-30~+100°C	Room temperature 12 hrs. and 140°C 3 hrs.

NB: Shelf life

Effective storing duration on condition that the adhesive is properly kept in a cool, dry and dark place such as a refrigerator (+5~+10°C, do not store in a freezer).

Thumb pressure 100~300kPa

Point

- In general, curing time of an adhesive called "room temperature curing type" is largely affected by environmental conditions such as temperature and humidity. Referring to the curing conditions described in the supplied operation manual, it is recommended to carry out a "test curing" on the site.
- A trace of water in the air is required to cure the CN adhesive (cyanoacrylate). Therefore the curing time is largely affected by humidity rather than temperature.

For two-component adhesives, use the supplied mixing vessels.

Mixing vessels: Polyethylene make
75mm-diameter, 10mm depth

* : These contents are for outside Japan.





Shelf life	Applications
6 months	Single component adhesive for strain gauges. The time required to bond the gauge is extremely short and handling is very easy. The thin bonding layer allows adhesion to plastic objects as well as metal. Curing time under normal conditions is 20~60 seconds.
6 months	Single component adhesive featuring high viscosity for bonding strain gauges to porous materials such as concrete and mortar. Curing time under normal conditions is 40~120 seconds.
3 months	Single component adhesive for accelerating cures in lower ambient temperature, or lower relative humidity. Curing time under normal conditions is 10~30 seconds.
6 months	Single component adhesive designed exclusively for use on post-yield strain gauge. Offers minimum degradation in bonding performance (peel strength) due to aging. Suitable when a large strain measurement is made after a few days or more of bonding the strain gauge. Curing time under normal conditions is 60~120 seconds.
6 months	Two-component room-temperature-curing polyester adhesive for bonding PF, P and F series strain gauges. Put the necessary quantity of drug A in the supplied mixing vessel, then add drug B by drops to total 2~6% in weight of drug A. Use the mixed adhesive within 5~15 minutes.
3 months	Two-component room-temperature-curing polyester adhesive for bonding PF and P series strain gauges. The mixing procedure is the same as above for P-2 adhesive. Put the necessary quantity of drug A in the supplied mixing vessel, then add drug B by drops to total 2~4% by weight of drug A. Use the mixed adhesive within 10~20 minutes.
3 months	Two-component room-temperature-curing polyester adhesive. Use as a surface precoating agent for bonding P and PF series gauges to concrete and also as an adhesive for WFLM series gauges. The special filler contained exhibits alkali resistance and effectively shuts off moisture and gas from inside of the concrete. Its high viscosity enables use on vertical walls or ceilings. Put the necessary quantity of drug A in the supplied mixing vessel, then add drug B by drops to total 2~4% by weight of drug A.
6 months	Two-component room-temperature-curing polyester adhesive for bonding QF, ZF and BF series strain gauges. Put the necessary quantity of drug A into the supplied mixing vessel then add drug B by drops to total 3~4% by weight of drug A. Use the mixed adhesive within 5~20 minutes.
3 months	Single-component heat-curing type adhesive. For use on strain gauges that are suited to heat curing. Enables reliable measurement for long periods and in high temperature up to 200°C.
3 months	Two-component room-temperature-curing epoxy adhesive for bonding CF series strain gauges for use in temperature from cryogenic (-269°C) up to 50°C. Mix the necessary quantity of drugs A and B at the weight ratio of 2 to 1.
3 months	Two-component room-temperature-curing epoxy adhesive for bonding strain gauges for use in temperature from -60 to +200°C. Enables stable measurement for a long period of time. Mix the necessary quantity of drugs A and B at the weight ratio of 10 to 3.
3 months	Two-component heat-curing epoxy adhesive for bonding BTM strain gauges. Mix the necessary quantity of drugs A and B at the weight ratio of 10 to 1, then pour the mixed adhesive into a hole drilled on the bolt in which the gauge is inserted. Keep at room temperature for 12 hours, then cure at 140°C in furnace for 3 hours.

SDS : Safety Data Sheet

TML supplies SDS for all its strain gauge adhesives and coatings. Contact your TML supplier for more information.



COATING MATERIALS



COATING MATERIALS						
Type	Materials	Color	Contents	Operating temperature	Curing conditions	
W-1	Microcrystalline wax solid	Light yellow	500g	0~+50°C	Hot melting +100~+120°C Hardening in room temperature	
N-1	Chloroprene rubber based solvent thinned	Light yellow	25g *	-30~+80°C	Air-drying A half day in room temperature	
K-1	Special rubber based solvent thinned	White	25g *	-269~+60°C	Air-drying A half day in room temperature	
UE-1	Special rubber based solvent thinned	Brown	25g *	-40~+150°C	Air-drying A half day in room temperature	
SB tape	Buthyl rubber	White	10mm(wide)x3mm (thick) 5m long/roll	-30~+80°C	Pressure sensitive	
VM tape	Buthyl rubber	Black	38mm(wide) x1mm (thick) 6m long/roll	-20~+80°C	Pressure sensitive	
KE-348W	Silicone rubber	White	100g	-50~+200°C	Air-drying A half day in room temperature	
KE-348T		Transparent	100g			
TSE3976-B	Silicone rubber	Black	100g	-50~+250°C	Air-drying One day in room temperature	

SDS : Safety Data Sheet

TML supplies SDS for all its strain gauge adhesives and coatings. Contact your TML supplier for more information.

Coatings in special substances

For use in special substances such as acids, alkalis and alcohols, contact TML or your local representatives.

* : These contents are for outside Japan.

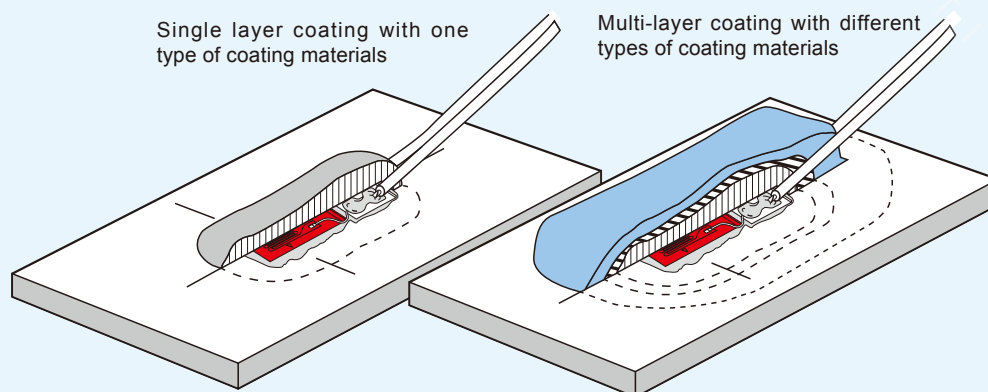

The type of coating required and the application method differ depending on the environment in which the strain gauge is used. In general, if one type of coating is not sufficient, multiple coatings can be combined to protect the strain gauges. At TML, the coating applied directly to the surface

of the strain gauge is referred to as the first coating with subsequent coating layers referred to sequentially as the second coating, third coating, etc. Multi-layer coatings offer better strain gauge protection.



Purpose	Applications
Moisture- and water-proofing coating for laboratory and field requirements where mechanical protection is not needed, or used as the first coating for multi-layer coating.	The solid W-1 is put into a heating apparatus (temperature-regulated oil bath is recommended) and completely melted at 100 to 120°C. The hot melted W-1 is applied over the area to be coated with a brush. The W-1 cools down and turns into solid as soon as applied. It is usually applied repeatedly till the cooled W-1 forms an adequate thickness.
Moisture- and water-proofing coating for laboratory and less severe field requirements where mechanical protection is not needed.	A layer of N-1 is applied directly from the tube or with a brush over the area to be coated. Curing time is about half a day in room temperature, but it depends on conditions such as the specimen material, temperature, and so on. If the coating layer is too thin, apply on more layer to make an adequate thickness.
Moisture-proofing coating from cryogenic to room temperature for laboratory requirements. Does not provide a high degree of mechanical protection.	A layer of K-1 is applied directly from the tube or with a brush over the area to be coated. Curing time is about half a day in room temperature, but it depends on conditions such as the specimen material, temperature, and so on. If the coating layer is too thin, apply on more layer to make an adequate thickness.
Oil-resistant coating for laboratory and field requirements. Does not provide a high degree of mechanical protection.	A layer of UE-1 is applied directly from the tube or with a brush over the area to be coated. Curing time is about half a day in room temperature, but it depends on conditions such as the specimen material, temperature, and so on. If the coating layer is too thin, apply another layer to make an adequate thickness.
Moisture- and water-proofing coating for laboratory and field requirements where mechanical protection is not needed, or used as the first coating for multi-layer coating. Offers excellent moisture and water resistant characteristics and is very convenient for use.	The SB tape is cut in an appropriate length and applied over the area to be coated. The application is completed by pressing down the SB tape firmly with a spatula or your finger covered with the separating paper. It is also applied under the leadwire prior to the overcoating.
Used as the second coating or later for multi-layer coating. Offers excellent moisture and water resistant characteristics. Very convenient for use.	The VM tape is cut in an appropriate length and applied over the area to be coated with finger pressure. The VM tape must not be applied directly over a strain gauge as a first coating.
Suitable for laboratory requirements with high temperature conditions where high degree of mechanical protection is not needed.	The KE-348 is applied directly from the tube over the area to be coated. Curing time is about one day in room temperature, but it depends on conditions such as temperature, humidity and so on.
Suitable for laboratory requirements with high temperature conditions where high degree of mechanical protection is not needed.	The TSE3976-B is applied directly from the tube over the area to be coated. Curing time is about one day in room temperature, but it depends on conditions such as temperature, humidity and so on.

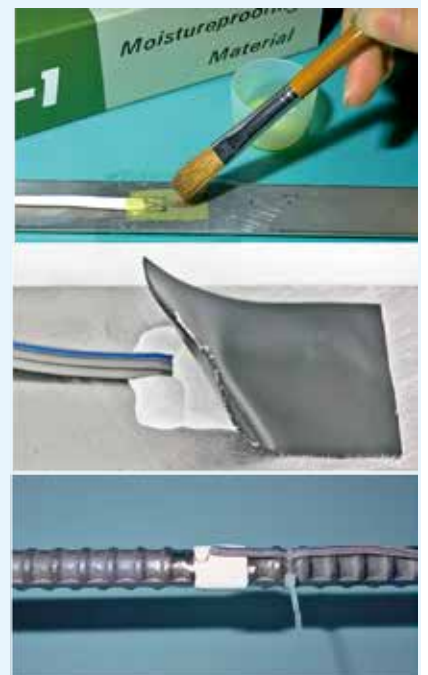

GAUGE PROTECTOR

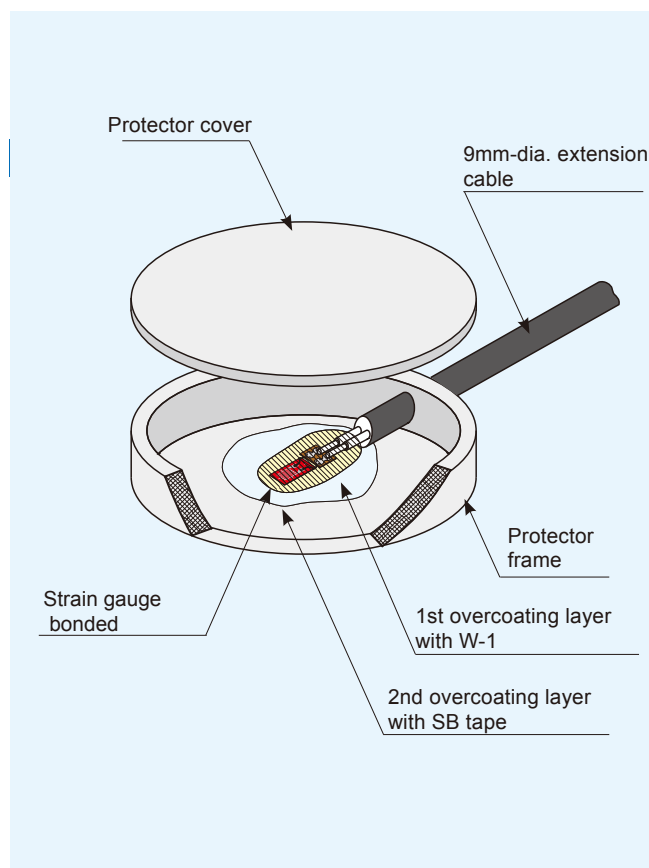

This rubber protector is designed to protect gauges which are bonded onto metal surface from the environment for long-term measurement. The strain gauge is packed inside together with the applied adhesive and overcoating materials. The protector is also provided with a hole for cable intake. It allows the entire area to be isolated from ambient conditions which may affect reliable measurement, and enhances the coating performance.

Specifications

Dimensions	Frame: ϕ 100mm (Inner ϕ 92mm) x 15mm (Height) Cover: ϕ 100mm x 3mm (Thick)
Operating temperature	-20 ~ +80°C
Extension cable	ϕ 9mm cable recommendable



COATING TAPE for reinforcing bar

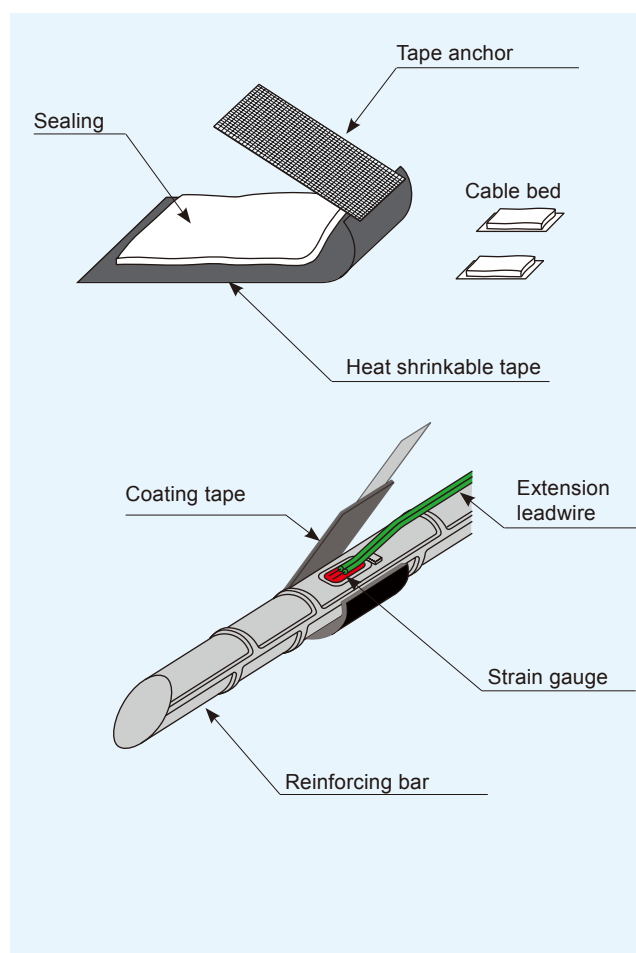

This tape is specially designed for use as a waterproof coating for stain gauges bonded onto reinforcing bars or other cylindrical surfaces. Coating is achieved by simply taping it onto the surface to save considerable time in comparison with conventional procedures. (A heat gun is required for application.)

Specifications

Operating temperature: -20~+80°C

Type	Applicable re-inforcing bar	Qty. per box	Strain gauges	Size finish (example)	
				Reinforcing bar	Dia. x Width (mm)
CT-D04	D4	10	FLK-2-11	D4	ϕ 10x21
CT-D06	D6	10	FLK-2-11	D6	ϕ 12x21
CT-D10	D10	10	FLK-2-11	D10	ϕ 15x21
CT-D13	D13	10	FLA-3-11	D13	ϕ 19x26
CT-D16	D16	10	FLA-3-11	D16	ϕ 21x26
CT-D25	D19~D25	10	FLA-3-11	D25	ϕ 31x31
CT-D35	D29~D35	10	FLA-3-11	D32	ϕ 37x35



Frictional Axial Strain Transducer FGAH-1B



This transducer measures axial strain of steering tie-rod of a car and consists of two types FGAH-1B-R and FGAH-1B-H for which a cross section of the rod is round shape or hexagon's. It is also suited to measure axial strain of a tension rod used in aseismic reinforcement structure or in steel frame structure. Since frictional strain gauges are used in this transducer, installation is completed and it gets ready for measurement by merely pinching the rod with the transducer, without detaching the rod. There is no need of technical skill and complicated works for attaching strain gauges on the rod.

NB:

- Frictional strain gauges are consumable parts.
- Applicable type of frictional strain gauges is CBFC-2 (option).



■Dimensions

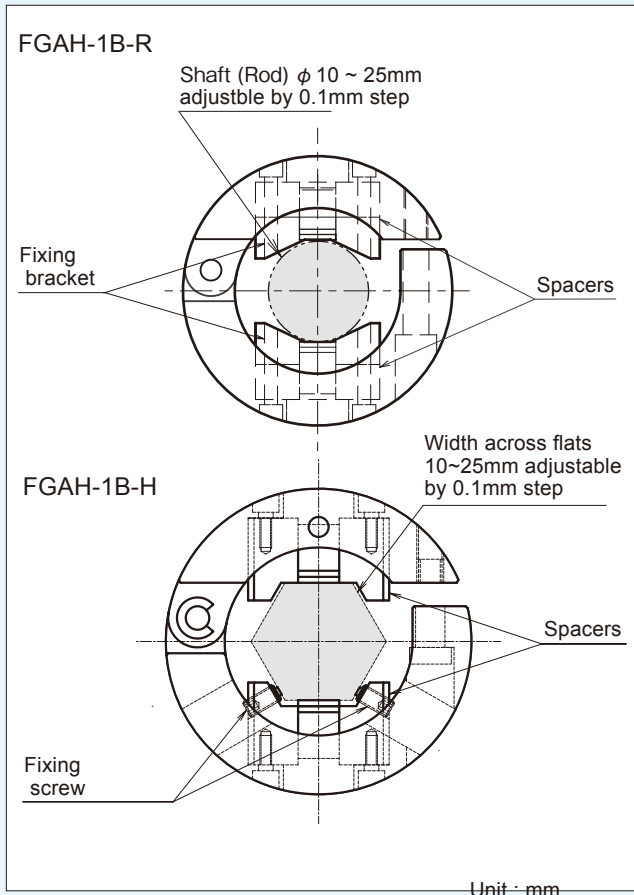

Applicable not only for tie-rod of motor cars but also for tension rod of architectural structures

- Easily installed by just clamping-on without detaching the existing tie-rod
- Tensile force management of rod between sheet piles or in architectural structures is easily achieved – The transducer can be used repeatedly
- Applicable rod:
FGAH-1B-R : Diameter is 10 to 25mm
FGAH-1B-H : Width cross flats 10 to 25mm (Optional spacers are required)
- Small and light construction which allows installation in a narrow space

■Specifications

Type	FGAH-1B-R	FGAH-1B-H
Applicable shaft	Round shape φ 10 ~ 25mm	Hexagon shape Width across flats 10~ 25mm
Capacity	±1000×10 ⁻⁶ strain	
Rated output	Approx. 2600×10 ⁻⁶ strain	
Non-linearity	1%RO	
Allowable temperature range	-30 ~ +60°C (no dew condensation)	
Frequency response	Approx. 6.5kHz	
Input/output resistance	1000Ω±3%	
Dimensions	Approx. φ 52x35mm	
Weight	Approx.55g(excluding spacers and cable)	
Protection rating	Equivalent to IP51	
Recommended exciting voltage	2V	
Allowable exciting voltage	5V	
Input/output cable	φ 3.2mm 0.08mm ² 4-core shielded vinyl cable 5m	

■Installation image

Installation on tension rod of a seismic reinforcement structure

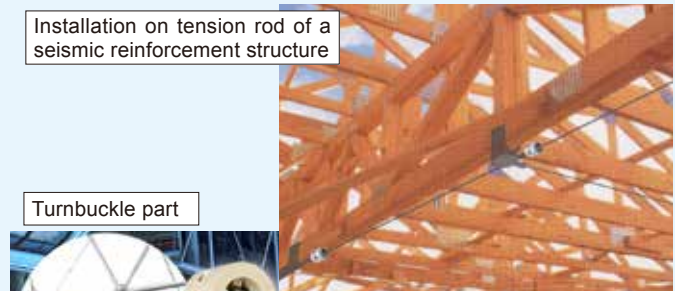

Turnbuckle part



Installation on steering tie-rod of a car





Frictional Torque Sensor System FGDH-2A

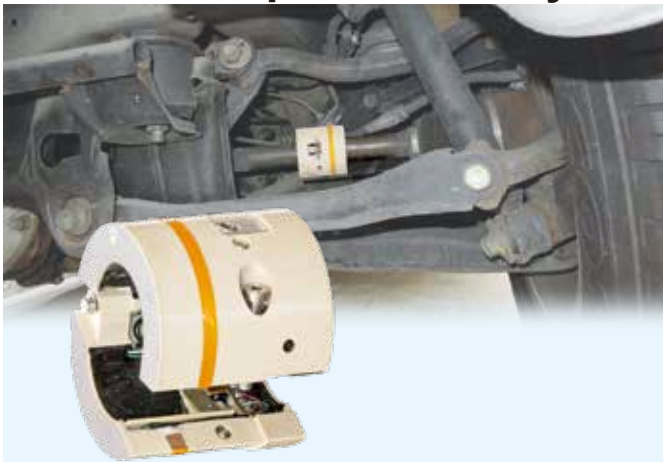

Features

- Easily installed by just clamping-on without detaching the drive shaft
- No bonding is required because frictional strain gauges are used
- Wireless transmission of measured data – no wiring is required
- Noise resistant measurement by the use of digital telemetry system
- Applicable shaft diameter is 20 to 30mm (optional spacers are required)
- Battery is rechargeable with the sensor installed on the shaft

Torque sensor system measures torque on the drive shaft of a car. Frictional strain gauges are used as sensing elements, and the installation is completed by clamping the torque sensor system onto an existing shaft and securing it with a screw. There is no need of detaching the shaft, bonding, nor wiring strain gauges for the installation. The system is applicable to shafts having a diameter of 20mm to 30mm using spacers together, which are available as options. A digital telemetry transmitter is built in the sensor, and measured data are transmitted to an exclusive receiver DT-041R-1 by wireless and output as analog signals. For wireless transmission, 315MHz band extremely low power radio wave is used.

Dimensions

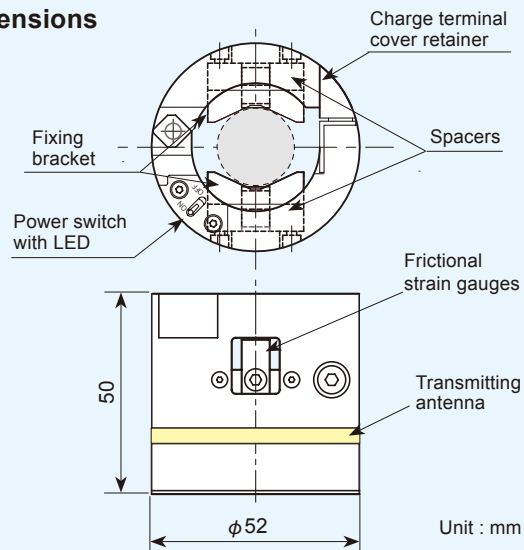

Name of each part

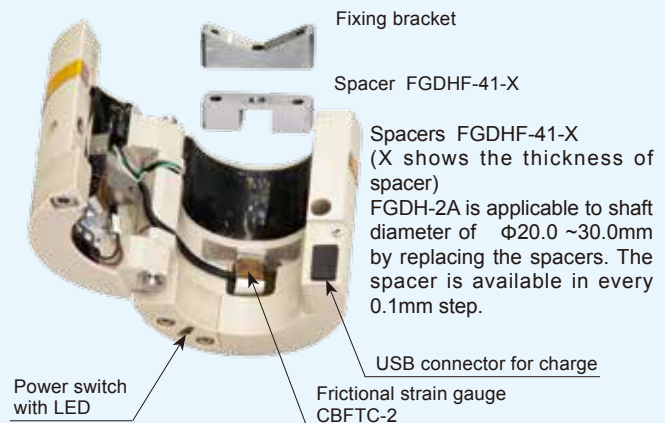

Specifications

Type	FGDH-2A
Applicable shaft diameter	φ20.0 ~ 30.0mm
Capacity	Depends on the diameter (outer/inner) and material of the shaft
Output	Depends on the diameter (outer/inner) and material of the shaft However, within $\pm 16000 \times 10^{-6}$ strain including initial unbalance of $\pm 2000 \times 10^{-6}$ strain
Non-linearity	1%RO
Allowable temperature	-20 ~ +60°C (no dew condensation)
Sampling frequency	10kHz
Frequency response	Approx. 1.1kHz
Carrier frequency	315 ~ 321MHz
Number of wireless channels	4
Dimensions	φ52 x 50mm
Weight	Approx. 85g (excluding spacer)
Protection rating	Equivalent to IP51
Continuous operating time	Approx. 8 hours (23±5°C)
Power source	Lithium secondary battery
Accessory	USB charger

NB:

- FGDH-2A uses 315MHz band extremely low power radio wave for wireless transmission.
- This system is not approved for use outside Japan.
- Frictional strain gauges are consumable parts.
Applicable type of frictional strain gauge is CBFTC-2 (option).
- A torque driver is required for installation of FGDH-2A.

Measuring system

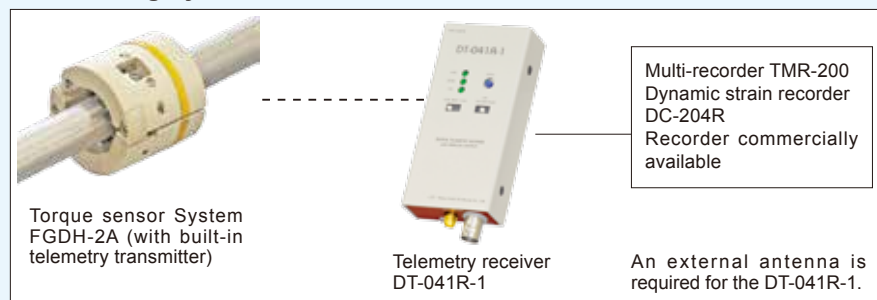

Frictional Torque Sensor System FGDH-3A



Torque Sensor System measures torque on the drive shaft of a car. Frictional strain gauges are used as sensing elements, and installation is completed by clamping the torque sensor system onto an existing shaft and securing it with a screw. There is no need of detaching the shaft, bonding nor wiring strain gauges for installation. The system is applicable to shafts having diameter of 20mm to 30mm using spacers together, which are available as options. A digital telemetry transmitter is built in the sensor, and measured data are transmitted to an exclusive receiver DT-182R by wireless and output as analog signals. For wireless transmission, 2.4GHz band advanced low power data communication system is used.

Features

- Easily installed by just clamping-on without detaching the drive shaft
- No bonding is required because frictional strain gauges are used
- Wireless transmission of measured data – no wiring is required
- Globally standardized 2.4GHz band data communication system is used for noise resistant digital transmission
- Applicable shaft diameter is 20 to 30mm (optional spacers are required)
- Battery is rechargeable with the FGDH installed on the shaft
- Power saving function provided

■ Specifications (Torque transducer)

Type	FGDH-3A
Applicable shaft diameter	φ20.0 ~ 30.0mm
Capacity	Depends on the diameter (outer/inner) and material of the shaft
Output	Depends on the diameter (outer/inner) and material of the shaft However, within $\pm 16000 \times 10^{-6}$ strain including initial unbalance of $\pm 2000 \times 10^{-6}$ strain
Non-linearity	1%RO
Allowable temperature	-20 ~ +60°C (no dew condensation)
Sampling frequency	5kHz
Frequency response	1kHz
Wireless specifications	Conforms to 2.4GHz band advanced low power data communication system
Number of wireless channels	16
Dimensions	φ52 x 50mm
Weight	Approx. 85g (excluding spacer)
Protection rating	Equivalent to IP51
Continuous operating time	Approx. 6 hours (23±5°C)
Power source	Lithium secondary battery
Accessory	USB charger

NB:

- This system is approved for use in Japan, People's Republic of China, and EU. Please contact us for other countries.
- Frictional strain gauges are consumable parts.
Applicable type of frictional strain gauge is CBFTC-2-005CT. (option)
- A torque driver is required for the installation of FGDH-3A

■ Dimensions

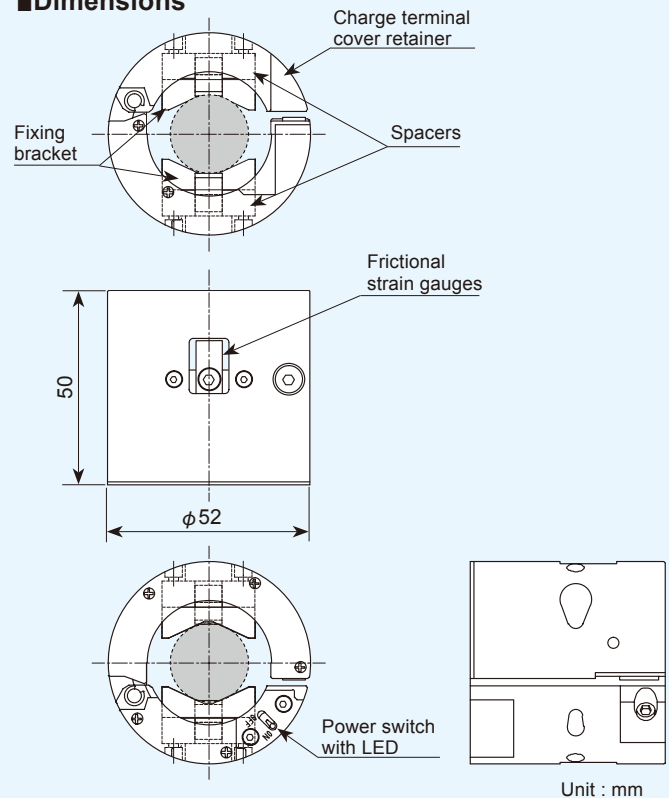

■ Specifications (Receiver)

Type	DT-182R
[Wireless part]	
Number of receptions	1
Wireless specifications	Conforms to 2.4GHz band advanced low power data communication system
Number of wireless channels	16 channels (Set by wave channel switch)
Antenna connecting terminal	SMA connector
[Voltage output part]	
Number of voltage outputs	1 of either received strain value or transmitter battery voltage (BNC)
Strain measurement	$\pm 5V$ FS (at $\pm 16000 \times 10^{-6}$ strain input, 5kΩ load)
Transmitter battery voltage measurement	+1.3 ~ +3.9V (5kΩ load)
Voltage output accuracy	$\pm 0.5\%$ FS (Entire system)
Stability on zero	$\pm 0.55mV/^\circ C$ (Entire system)
Stability on sensitivity	$\pm 0.05\%$ FS/ $^\circ C$ (Entire system)
SN ratio	47dB
Calibration output level	$\pm 5V$
Low-pass filter	100Hz, 500Hz, PASS(1kHz)(-3dB±1dB)
Balancing range	$\pm 6000 \times 10^{-6}$ strain
Balancing accuracy	$\pm 5mV$
Display/Operation	LED for output level, Low-pass filter selection switch, Calibration output selection switch, Balancing switch
[General Specifications]	
Power source voltage	DC9~16V
Current consumption	80mA Max. (when DC12V is supplied at +23°C ±5°C)
Connector	HOSHIDEN HEC3800 (Compatible plug : φ5.5x3.3 PIN φ1mm)
Operating environment	0 ~ +50°C, 85%RH or less (no dew condensation)
External dimensions	48(W) x 23.5(H) x 100(D) mm (except projecting parts)
Weight	Approx. 140g
Standard accessory	BNC coaxial cable (CR-31) DC power cable (CR-062) Receiving antenna (AA2402RSPU)

NB:

- Coaxial cable for the extension of receiving antenna is required.
C3RSPJ-EXT-1M (1m long), C3RSPJ-EXT-3M (3m long), C3RSPJ-EXT-5M (5m long)

Frictional Strain Checker FGMH series

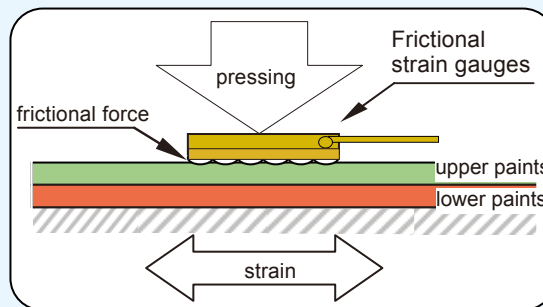

No bonding is required for strain measurement on steel

- Easy mounting and detaching by lever operation
- Paint removal, grinding, bonding and curing are not necessary
- Can be used repeatedly
- Strain measurement in three directions (FGMH-3A)

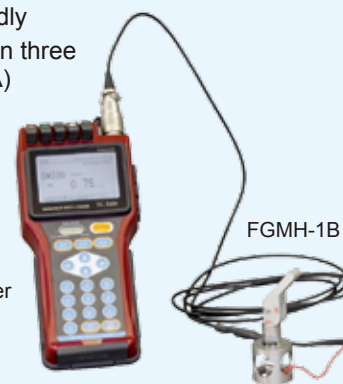

Handheld Data Logger
TC-32K

FGMH-1B

The Strain checker FGMH series measures strain using frictional force working on the contact surface of the frictional strain gauge by pressing the gauge against the structure with magnetic force. Unlike bondable strain gauges, surface preparation and bonding works are not required for this gauge, thus the works required for strain measurement are largely reduced. In combined use with a handheld type strainmeter, the strain checker can easily measure strains on steel materials such as bridges by changing measurement point one after another. It is the most suited to preparatory measurements before starting a long term measurement.

In the FGMH series, three types are available. They are FGMH-1B and FGMH-2A both for single axis measurement and FGMH-3A for 0°/45°/90° three-axis measurement.

Single axis measurement FGMH-1B/FGMH-2A

FGMH-1B



The FGMH-1B is a strain checker constructed small and light. The frictional strain gauge is set to on, off and replacing position by the operation of lever, thus allowing easy handling of the strain checker. The frictional strain gauge is a consumable part. If it is stained, deteriorated or damaged, replace it with a new one.

Option: Applicable frictional strain gauge CBF-6-01LOP

FGMH-2A

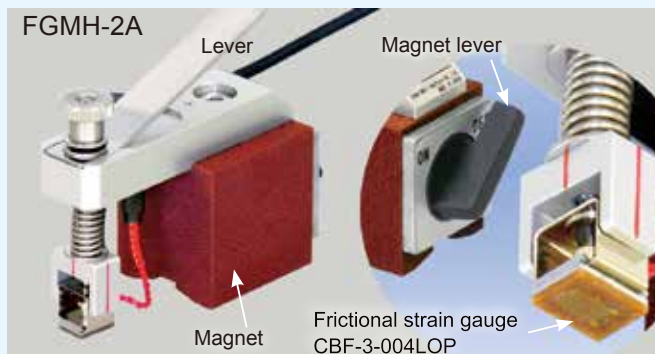

The FGMH-2A is a strain checker especially designed for measurement on a small area such as the vicinity of a welded part. It can be easily attached to and detached from measurement object by the operation of magnet lever. In addition, a lever is provided on the upper part to slightly lift the frictional strain gauge from the measurement surface by pushing the lever downward. It enables easy adjustment of the direction of the strain gauge. The frictional strain gauge is a consumable part. If it is stained, deteriorated or damaged, replace it with a new one.

Option: Applicable frictional strain gauge CBF-3-004LOP

Three-axis measurement 0°/45°/90° FGMH-3A

FGMH-3A

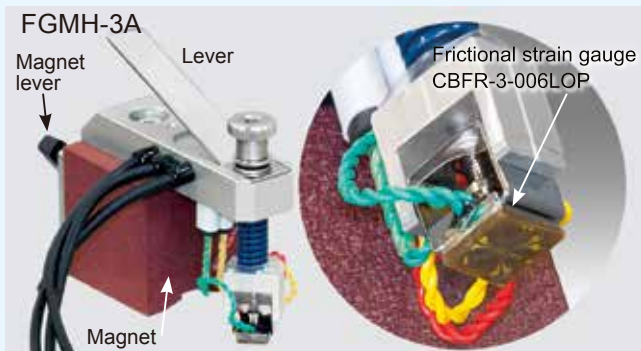

The FGMH-3A is a strain checker for three-axis measurement in 0°/45°/90°. Principal stress (principal strain) and its direction can be found by applying rosette analysis calculation to the measured strain values in three directions. It is applicable to measurement in the vicinity of weld bead like as the FGMH-2A. Also similarly as the FGMH-2A, it can be easily attached to and detached from a measurement object by the operation of magnet lever. Another lever is provided for easy adjustment of the direction of the strain gauge. The frictional strain gauge is a consumable part.

If it is stained, deteriorated or damaged, replace it with a new one.
Option: Applicable frictional strain gauge CBFR-3-006LOP

Application examples

- Preparatory measurement of bridge which will undergo a long term measurement
- Investigation of neutral axis position of composite girder bridge
- Stress direction of structural member of bridge on which fatigue crack is initiated
- Stress measurement of newly built bridge where paint removal is not available.

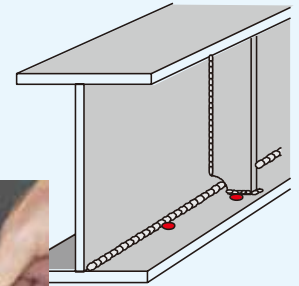

Strain measurement in a narrow area

Stress concentration is caused in the vicinity of weld bead, which is deposit of welded materials along the welding pass. The strain checker FGMH-2A/FGMH-3A is capable of strain measurement in a narrow area such as the vicinity of weld bead because it is easily attached and detached by ON/OFF operation of the magnet lever. Strain in three directions can be measured simultaneously by the use of FGMH-3A.



Specifications

Type	FGMH-1B	FGMH-2A	FGMH-3A
Number of axes	Single axis		Three-axis
Gauge length	6mm	3mm	
Operating temperature	0 ~+60°C		
Compensated temperature range	0 ~+60°C		
Objective material	Metal, Steel (Coefficient of thermal expansion 11ppm/°C)		
Input/Output resistance	120Ω		
Gauge factor	Approx. 2		
Measurement mode	Full bridge		
Input/Output cable	-	φ 3mm 0.05mm ² 4-core shielded chloroprene cable of 2m NDIS 7-pin plug attached	
Supplied cable	Leadwire with bridge circuit board 2m, NDIS 7-pin plug attached	-	
Weight (excluding cable)	Approx. 60g	Approx. 260g	

Note:

- The strain checker is installed on a measurement object by magnetic force. It is not applicable to measurement on non-magnetic materials.
- The strain checker is not applicable to the use on a curved or uneven surface.
- If the vicinity of the strain checker is hit strongly with a hammer or equivalent, a shift in the measured value may be caused.
- Correct measurement may not be possible by the strain checker on a machine or structure experiencing strong vibration.
- For more precise measurement, it is recommended to remove the paint and to bond an ordinary strain gauge on the base metal surface.

Dimensions

FGMH-1B (Single axis)

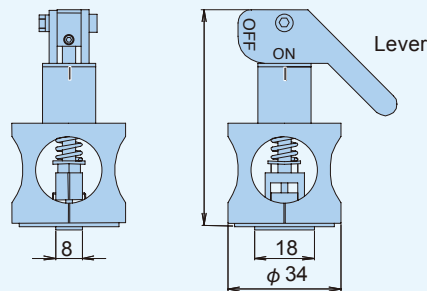

FGMH-2A (Single axis)

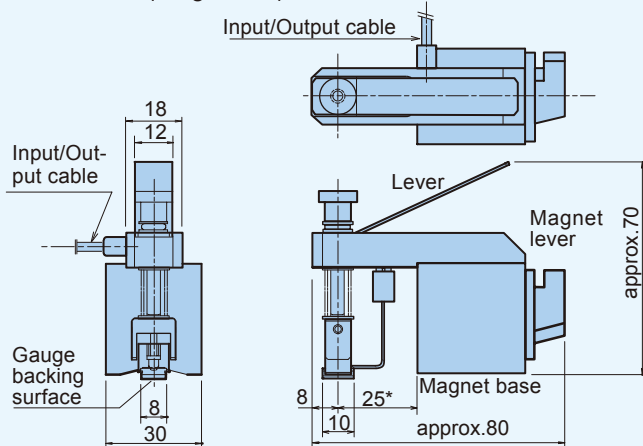

FGMH-3A (0°/45°/90° Three-axis)

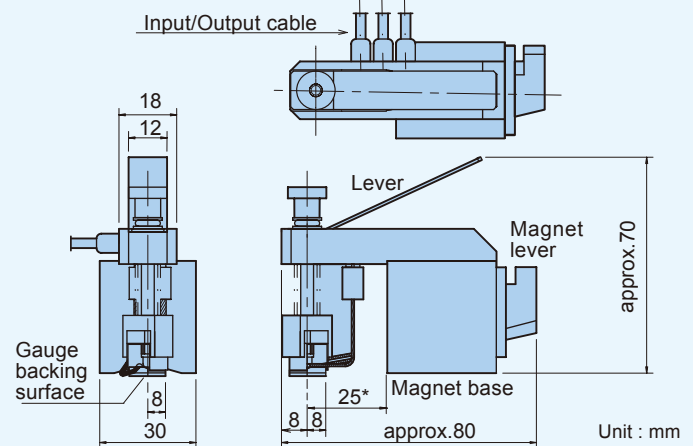

*: Where the gauge backing surface is in parallel with the magnet base. (FGMH-2A, FGMH-3A)

TML Strain measuring instruments

TML Data logger series

Data loggers of high accuracy and stability developed through many years of experience



- Highly accurate measurement in wide measurement range is achieved owing to the use of A/D converter with high accuracy and resolution and auto-ranging function
- TDS-630 with extremely high speed measurement capability and versatile functions
- TDS-540 with excellent adaptability for various usage conditions
- TDS-150 for on-site measurement of comparatively small scale
- TC-32K of handheld design for simple measurement and checking
- Input is selectable arbitrarily among strain, voltage, thermocouple and PtRTD for each channel
- External switching boxes are available for each data logger

Software TDS-7130V2 for TDS-630, TDS-540 and TDS-150

- Data analysis using various calculation functions
- Visually appealing measurement possible using various monitor graphs and numerical monitor displays
- Other graph data are easily overlaid and quick data reduction is enabled
- Alarm setting possible for each measured value and calculation result

Software TDS-700L for TDS-540, TDS-150 and TC-32K

- Direct saving of measured data into Excel worksheet
- Simple and quick operation from measurement to data processing possible utilizing Excel functions
- Number of measurement channels is 200 at the maximum

Data Logger	TDS-630	TDS-540	TDS-150	TC-32K
Number of channels of Built-in Switching Box	30 ch.	30 ch.	-	1 ch.
Number of channels	1000 ch.	1000 ch.	50 ch.	5 ch.
Compatible Switching Box	IHW-50H/IHW-50G	IHW-50G/ISW-50G	FSW-10/FSW-10L	CSW-5B/-5B-05
Number of channels	50 ch.	50 ch.	10 ch.	5 ch.
Scanning Time	IHW-50H 0.1 s/1000 channels IHW-50G 0.4 s/1000 channels	IHW-50G 0.4 s/1000 channels ISW-50G 2 s/1000 channels	4 s/50 channels	0.4 s/5 channels
Interface	LAN/USB/RS-232C		USB/RS-232C	
Strain Measurement				
Resolution High resolution mode	(1, 2, 4, 8 or 16)×10 ⁻⁶ strain (0.1, 0.2, 0.4, 0.8 or 1.6)×10 ⁻⁶ strain Depending on measured value		(1 or 10)×10 ⁻⁶ strain - Depending on measured value	
Measuring Range High resolution mode	640000×10 ⁻⁶ strain 64000.0×10 ⁻⁶ strain		300000×10 ⁻⁶ strain -	
DC Voltage Measurement				
Resolution V1/100 range V1/1 range	(0.1, 0.2, 0.4, 0.8 or 1.6) mV (1, 2, 4, 8 or 16) μV Depending on measured value		(0.1 or 1) mV (1 or 10) μV Depending on measured value	
Measuring Range V1/100 range V1/1 range	64 V 640 mV		30V 300mV	
Applicable thermocouple	T, K, J, B, S, R, E, N			
Applicable Pt-RTD	Pt 100 3-wire			
Power supply	AC 100~240 V 50/60 Hz		DC 9~18 V	
			D battery 4pcs.	AA battery 4pcs.
Applicable Software	TDS-7130v2			-
	-	TDS-700L		

Multi-Channel dynamic data acquisition system with DS-50A
 A low cost measurement system mainly targeted on strain gauges



- 50 measurement channels for one set of DS-50A
- Simultaneous sampling of 1 millisecond possible when one set is used
- Direct connection of 120Ω or 350Ω strain gauge in quarter bridge
- Numerical, statistical and trigonometric calculation and rectangular rosette analysis
- Peak values of up to 20 points are displayed in the spectral chart
- Magnitude and direction of the force obtained by rectangular rosette analysis are displayed as a vector
- Cutting out, thinning and combining of the data are possible for processing after the measurement
- Overlapping of T-Y, X-Y and spectral chart on other data is possible

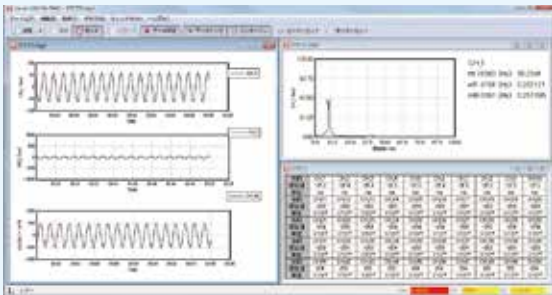

Number of channels	Maximum 50 channels Strain, Voltage and Thermocouple units can be mixed. 10 channels / 1 unit
Synchronization	Maximum 20 sets (1,000 channels)
Sampling speed	1~10,000 ms (Settable by 1 ms). 1 ms is added to sampling speed per additional connection of 1 set
Interface	LAN (100 BASE-TX)
Strain unit	
Gauge resistance	Quarter bridge 3-wire 120Ω, 350Ω Half bridge 120~1000Ω, Full bridge 120~1000Ω
Frequency response	DC 100Hz
Voltage unit	
Input format	Single end (unbalanced)
Measuring range	±20V
Frequency response	DC 100Hz
Thermocouple unit	
Measuring range	T:-250~ +400°C K:-210 ~ +1370°C J:-200~ +1200°C
Frequency response	DC~10Hz

Small yet versatile and multi-inputs Multi-Recorder TMR-200 Series

Number of channels : 80
 Sampling speed : Max 100kHz
 Recording media : CF card (Max.32GB)
 Interface : LAN, USB



This is a multi-functional data acquisition system capable of inputting various sensors. It is suited to vehicle onboard measurement with its small and vibration-tolerant construction. It is also equipped with functions of data recovery against power source interruption and measurement restart after the recovery. A long term measurement is possible by using a large capacity CF card. Furthermore, real time histogram analysis is possible by adding the optional histogram analysis library.

Measuring units

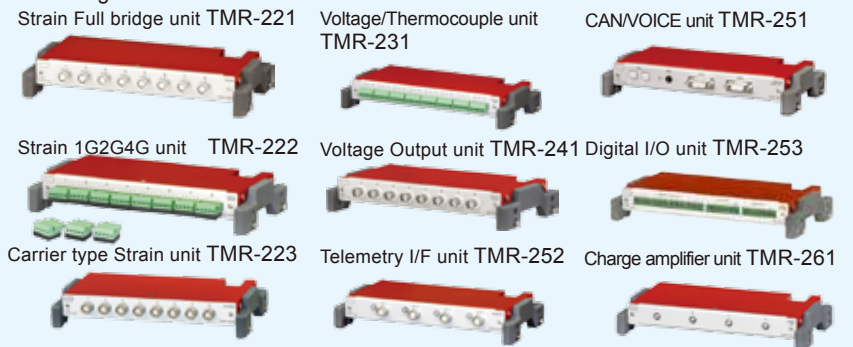

OPTION

Histogram analysis library TMR-211-01

By installing the TMR-211-01 software in the control unit TMR-211, the function of a histogram recorder can be added to the TMR-200 system.



■Histogram recording in applications

It is well known that the majority of structures involve parts subjected to cyclic loads, resulting in structural failure, and such failure includes a correlation between stress and cycles. A random stresses usually take place in structural parts of vehicles, machinery and architecture. Understanding of failure mechanism due to such stresses as above is very important. For cyclic stresses in random, fatigue failure is typically characterized with the processed stress amplitude and its cycles by the Rain-flow counting method.

Frequency analysis TMR-7630H

Indication of various graphs such as monitor graphs in wave-forms, numerical values and X-Y, history graphs, spectrums and histograms.

Automatic measurement and data acquisition using interval, data trigger external trigger, free run, data comparator, and program

Histogram analysis:

Peak/Valley, MAX/MIN, AMP, TIME, LEVEL, Rain Flow

●Fatigue life prediction

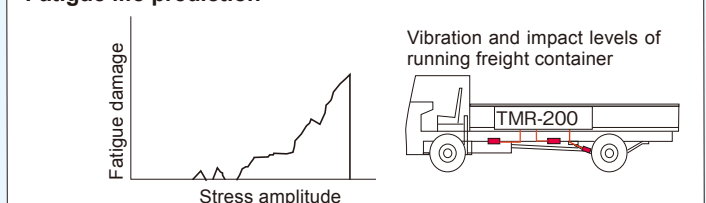



Tokyo Sokki Kenkyujo Co., Ltd.
www.tml.jp/e

8-2, Minami-Ohi 6-Chome, Shinagawa-Ku, Tokyo 140-8560, JAPAN
TEL: +81-3-3763-5614 FAX: +81-3-3763-5713
email address: **sales@tml.jp**