



# Multiple Application Platform

FVAi-2030 Benchtop Microscope

User Guide

22112369-339 R002, Standard

November 2023



## Copyright

Copyright © 2023 VIAVI Solutions Inc. All rights reserved. VIAVI and FiberChekPRO™ are trademarks or registered trademarks of VIAVI in the United States and/or other countries. All other trademarks and registered trademarks are the property of their respective owners. No part of this guide may be reproduced or transmitted, electronically or otherwise, without written permission of the publisher.

Every effort was made to ensure that the information in this manual was accurate at the time of printing. However, information is subject to change without notice, and VIAVI reserves the right to provide an addendum to this manual with information not available at the time that this manual was created.

## Patents

Patented as described at [www.viavisolutions.com/patents](http://www.viavisolutions.com/patents).

## Terms and Conditions

Specifications, terms, and conditions are subject to change without notice. The provision of hardware, services, and/or software are subject to VIAVI standard terms and conditions, available at [www.viavisolutions.com/terms](http://www.viavisolutions.com/terms).

## Disclaimer

The foregoing warranties are in lieu of all other warranties and conditions, expressed or implied. VIAVI specifically disclaims all other warranties, either expressed or implied, on any hardware, documentation or services including but not limited to warranties relating to quality, performance, non-infringement, merchantability or fitness for a purpose, as well as those arising from any course of dealing, usage or trade practice. Under no circumstances will VIAVI be liable for any indirect or consequential damages related to breach of this warranty.

## California Proposition 65

California Proposition 65, officially known as the Safe Drinking Water and Toxic Enforcement Act of 1986, was enacted in November 1986 with the aim of protecting individuals in the state of California and the state's drinking water and environment from excessive exposure to chemicals known to the state to cause cancer, birth defects or other reproductive harm. For the VIAVI position statement on the use of Proposition 65 chemicals in VIAVI products, see the **Hazardous Substance Control** section of the [VIAVI Policies & Standards](http://www.viavisolutions.com/policies-standards) web page.

## Federal Communications Commission (FCC) Notice

Electronic test equipment is exempt from Part 15 compliance (FCC) in the United States.

## Product Environmental Compliance

VIAVI is committed to compliance with all applicable laws and regulations controlling the use of hazardous substances in its products, as well as the disposal of equipment (including batteries) and waste packaging. For details, see the [VIAVI Policies & Standards](http://www.viavisolutions.com/policies-standards) web page or contact the VIAVI WEEE Program Management team at [Global.WEEE@ViaviSolutions.com](mailto:Global.WEEE@ViaviSolutions.com).

## EU REACH

Article 33 of EU REACH regulation (EC) No 1907/2006 requires article suppliers to provide information if a listed Substances of Very High Concern (SVHC) is present in an article above a certain threshold. For information on the presence of REACH SVHCs in VIAVI products, see the **Hazardous Substance Control** section of the [VIAVI Policies & Standards](http://www.viavisolutions.com/policies-standards) web page.

## EU CE Marking Directives (LV, EMC, RoHS, RE)

This product conforms with all applicable CE marking directives. Please request the EU Declaration of Conformity for details.

# China RoHS materials declaration



1445 South Spectrum Blvd., Suite 102  
Chandler, AZ 85286, USA

22157638, Rev 001

## “中国 RoHS”

《电子信息产品污染控制管理办法》（信息产业部，第 39 号）

附录 (Additional Information required for the Chinese Market only)

本附录按照“中国 RoHS”的要求说明了有关电子信息产品环保使用期限的情况，并列出了产品中含有的有毒、有害物质的种类和所在部件。本附录适用于产品主体和所有配件。

产品系列: FVAi Series Bench-Top Microscope with Integrated LCD Autofocus 30x  
(Product Family)

环保使用期限:



本标识标注于产品主体之上，表明该产品或其配件含有有毒、有害物质（详情见下表）。

其中的数字代表在正常操作条件下至少在产品生产日期之后数年内该产品或其配件内含有的有毒、有害物质不会变异或泄漏。该期限不适用于诸如电池等易耗品。

有关正常操作条件，请参见产品用户手册。

产品生产日期请参见产品的原始校准证书。

有毒、有害物质的类型和所在部件

元器件 (Component)	有毒、有害物质和元素					
	铅(Pb)	汞(Hg)	镉(Cd)	六价铬 (CR <sup>6+</sup> )	多溴联苯 (PBB)	多溴二苯醚 (PBDE)
产品主体 (Main Product)						
印刷电路板组件 (PCB Assemblies)	X	O	O	O	O	O
内部配线 (Internal wiring)	X	O	O	O	O	O
显示器 (Display)	X	O	O	O	O	O
键盘 (Keyboard)	O	O	O	O	O	O
电池 (Batteries)	O	O	O	O	O	O
电源 (Power Supply)	X	O	O	O	O	O
c 电工零件 (Electro-mechanical parts)	X	O	O	O	O	O
硬盘 (Hard Drive)	O	O	O	O	O	O
光模块 / 辅助模块 (Optical modules) / (Auxiliary modules)	X	O	O	O	O	O
金属外壳零件和紧固件 (Metal case parts and fixings)	X	O	O	O	O	O
塑料外壳零件 (Plastic case parts)	O	O	O	O	O	O
标签和胶带 (Labels and tapes)	O	O	O	O	O	O
配件 (Accessories)						
外接电缆和适配器 (External cables and adapters)	X	O	O	O	O	O
手册和其它印刷材料 (Handbooks and other printed material)	O	O	O	O	O	O
包装箱和绑带 (Carrying case and strap)	O	O	O	O	O	O
其它配件 (Other accessories)	O	O	O	O	O	O

本表是按照 S / T 11364 的规定编制的:

O: 表示该有害物质在该部件所有均质材料中的含量均在 GB/T 26572 规定的限量要求以下。

X: 表示该有害物质至少在该部件的某一均质材料中的含量超出 GB/T 26572 规定的限量要求。

# Contents

<b>1</b>	<b>FVAi-2030 Benchtop Microscope</b>	<b>1-1</b>
	Ordering information	1-2
	Technical Assistance Center and Knowledge Base	1-3
<b>2</b>	<b>Getting started</b>	<b>2-1</b>
	Features	2-2
	Powering the FVAi-2030 microscope on or off	2-3
	Mounting fiber adapters and connectors	2-4
	Navigating the Home screen	2-6
	Accessing Live view	2-8
	Applying a profile and an optical setting	2-10
	Managing groups	2-12
	Managing user information	2-14
	Managing microscope settings	2-15
	Managing the Fiber Centering Limit setting and marker	2-16
	Managing image-save options	2-18
	Managing system settings	2-19
	Calibrating the touchscreen	2-20
	Connecting and activating a supported USB device	2-21
	Activating a P5000i probe	2-21
	Activating an MP Series optical power meter	2-23
<b>3</b>	<b>Fiber inspection during standalone operation</b>	<b>3-1</b>
	Requirements for Pass/Fail tests	3-2
	Starting a Pass/Fail test from the FVAi-2030	3-3
	Viewing the fiber chamfer	3-4
	Capturing images	3-5
	Recalling test results and images	3-7
<b>4</b>	<b>Using the FVAi-2030 microscope with FiberChekPRO</b>	<b>4-1</b>
	Connecting to FiberChekPRO	4-2
	Performing Pass/Fail tests and generating reports	4-3
	Viewing the fiber chamfer with FiberChekPRO	4-5
	Creating analysis profiles for the FVAi-2030 microscope	4-6
	<b>Appendix A Firmware update</b>	<b>A-1</b>
	<b>Appendix B System reset</b>	<b>B-1</b>
	<b>Appendix C Specifications</b>	<b>C-1</b>
	<b>Appendix D Document revision history</b>	<b>D-1</b>



## About this guide

This guide provides information about the FVAi-2030 Benchtop Microscope. The following updates appear in this revision:

- Added the section “Safety instructions”
- Updated the section “Accessing Live view”

For a detailed revision history, see [“Document revision history” on page D-1](#).

To access the latest version of this user guide, go to:

[FVAi-2030 Benchtop Microscope User Guide, 22112369-339](#)

# Safety instructions



## CAUTION

Turn off the equipment, and disconnect all cables connected to it before moving the equipment or performing maintenance procedures.

## ATTENTION

Éteignez l'équipement et débranchez tous les câbles qui y sont connectés avant de déplacer l'équipement ou d'effectuer des procédures de maintenance.



## WARNING

- Only use power cords with adequate ratings and grounding-type plugs. Contact VIAVI for replacement power cords.
- Do not alter a power cord by modifying the grounding-type plug or using an adapter.
- Do not allow anything to rest on the power cord, and do not locate the equipment where persons can walk on the power cord.
- The equipment is rated for indoor use only. Do not use the equipment outdoors.
- To prevent potential fire or shock hazard, do not expose the equipment to any source of excessive moisture.
- Do not perform any operating or maintenance procedure that is not described in the user documentation. If the equipment is used in a manner not specified by VIAVI, the protection provided by the equipment might be impaired.
- Do not attempt to service this product yourself, as opening or removing covers might expose you to dangerous high-voltage points and other hazards. Refer all servicing to qualified VIAVI service personnel.
- Do not operate any equipment with its covers or panels removed.

## AVERTISSEMENT

- Utilisez uniquement des cordons d'alimentation avec des caractéristiques nominales adéquates et des fiches de type mise à la terre. Contactez VIAVI pour les cordons d'alimentation de remplacement.
- Ne modifiez pas un cordon d'alimentation en modifiant la prise de type mise à la terre ou en utilisant un adaptateur.
- Ne laissez rien reposer sur le cordon d'alimentation et ne placez pas l'équipement où des personnes peuvent marcher sur le cordon d'alimentation.
- L'équipement est conçu pour une utilisation en intérieur uniquement. Ne pas utiliser l'équipement à l'extérieur.
- Pour éviter tout risque d'incendie ou d'électrocution, n'exposez pas l'équipement à une source d'humidité excessive.
- N'effectuez aucune procédure d'exploitation ou de maintenance qui n'est pas décrite dans la documentation utilisateur. Si l'équipement est utilisé d'une manière non spécifiée par VIAVI, la protection fournie par l'équipement peut être altérée.
- N'essayez pas de réparer ce produit vous-même, car l'ouverture ou le retrait des couvercles peut vous exposer à des points haute tension dangereux et à d'autres dangers. Confiez tous les travaux d'entretien au personnel de service qualifié de VIAVI.
- N'utilisez aucun équipement dont les couvercles ou les panneaux ont été retirés.

# 1 FVAi-2030 Benchtop Microscope

The FVAi-2030 Benchtop Microscope is the ideal microscope to control contamination during optical connector manufacturing. Equipped with 30x optics, ultra-wide field-of-view, dual magnification, automatic focus, and built-in end face analysis, the FVAi-2030 gives operators fast and complete visibility of the entire ferrule end face so that any contamination on or near the fiber end face can be quickly found.

Operators can use the FVAi-2030 as a standalone device or in conjunction with the FiberChekPRO™ inspection and analysis software.

**Figure 1-1: FVAi-2030 Benchtop Microscope**



## **FiberChekPRO Fiber Inspection and Analysis software**

Designed to operate on a PC/laptop, FiberChekPRO instantly captures, analyzes, and grades fiber end-face images to determine acceptability of the end faces. It identifies and characterizes defects and contamination, and then provides a pass or fail result according to preconfigured criteria. In addition, users can customize settings, as well as archive data and generate reports.

This section covers the following information:

- [“Ordering information” on page 1-2](#)
- [“Technical Assistance Center and Knowledge Base” on page 1-3](#)

## Ordering information

**Table 1-1: FVAi-2030 Benchtop Microscope**

Description	Part Number
FVAi-2030 Large Field of View Benchtop Microscope <sup>1</sup> with Integrated LCD, Autofocus 30x	FVAi-2030

1. Includes M5 hex screwdriver, power adapter, and USB cable.

**Table 1-2: Supported fiber adapters**

Description	Part Number
LC/APC Duplex Fiber Microscope Adapter, 35-Degree Chamfer Angle	FMAX-LCA-DUX-SL35
LC/APC Fiber Microscope Adapter, 35-Degree Chamfer Angle	FMAX-LCA-SL35
LC/PC Duplex Fiber Microscope Adapter, 35-Degree Chamfer Angle	FMAX-LC-DUX-SL35
LC/PC Fiber Microscope Adapter, 35-Degree Chamfer Angle	FMAX-LC-SL35
SC/APC Fiber Microscope Adapter, 30-Degree Chamfer Angle	FMAX-SCA-SL30
SC/APC Fiber Microscope Adapter, 41-Degree Chamfer Angle	FMAX-SCA-SL41
SC/PC Duplex Fiber Microscope Adapter, 30-Degree Chamfer Angle	FMAX-SC-DUX-SL30
SC/PC Fiber Microscope Adapter, 30-Degree Chamfer Angle	FMAX-SC-SL30
Universal 1.25mm APC Fiber Microscope Adapter, 35-Degree Chamfer Angle	FMAX-U12A-SL35
Universal 1.25mm PC Fiber Microscope Adapter, 35-Degree Chamfer Angle	FMAX-U12-SL35
Universal 2.5mm APC Fiber Microscope Adapter, 30-Degree Chamfer Angle	FMAX-U25A-SL30
Universal 2.5mm APC Fiber Microscope Adapter, 41-Degree Chamfer Angle	FMAX-U25A-SL41
Universal 2.5mm PC Fiber Microscope Adapter, 30-Degree Chamfer Angle	FMAX-U25-SL30
CS/APC Fiber Microscope Adapter, 35-Degree Chamfer Angle	FMAX-CS-APC-SL35
CS/PC Fiber Microscope Adapter, 35-Degree Chamfer Angle	FMAX-CS-SL35
MDC/APC Fiber Microscope Adapter, 35-Degree Chamfer Angle	FMAX-MDC-APC-SL35
MDC/PC Fiber Microscope Adapter, 35-Degree Chamfer Angle	FMAX-MDC-SL35
SN/APC Duplex Fiber Microscope Adapter, 35-Degree Chamfer Angle	FMAX-SN-APC-SL35
SN/PC Fiber Microscope Adapter, 35-Degree Chamfer Angle	FMAX-SN-SL35



## Technical Assistance Center and Knowledge Base

To find the Technical Assistance Center phone number and email in your region for the FVAi-2030 Benchtop Microscope or to search the VIAVI Solutions Knowledge Base, visit the VIAVI Solutions Technical & Product Support site at [support.viavisolutions.com](https://support.viavisolutions.com).



## 2 Getting started

This section covers the following information:

- “Features” on page 2-2
- “Powering the FVAi-2030 microscope on or off” on page 2-3
- “Mounting fiber adapters and connectors” on page 2-4
- “Navigating the Home screen” on page 2-6
- “Accessing Live view” on page 2-8
- “Applying a profile and an optical setting” on page 2-10
- “Managing groups” on page 2-12
- “Managing user information” on page 2-14
- “Managing microscope settings” on page 2-15
- “Managing image-save options” on page 2-18
- “Managing system settings” on page 2-19
- “Connecting and activating a supported USB device” on page 2-21

## Features

Figure 2-1: FVAi-2030 microscope features (without adapter)

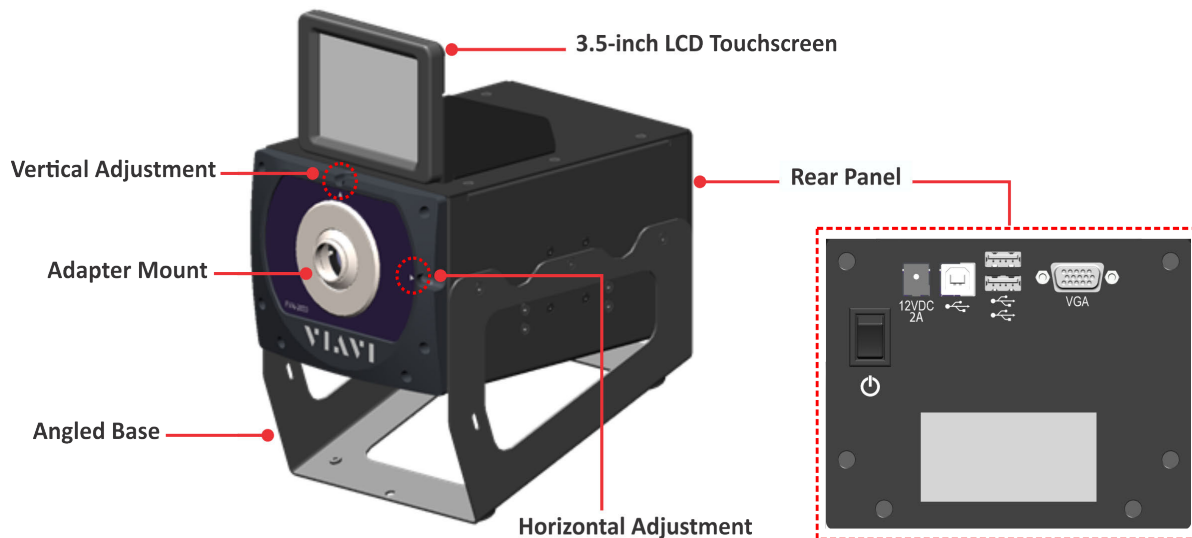







Table 2-1: FVAi-2030 microscope features - rear panel

Label	Description
	Power switch (ON/OFF). See <a href="#">“Powering the FVAi-2030 microscope on or off”</a> on page 2-3).
	Power adapter receptacle
	USB-B Interface (1x) for connecting the FVAi-2030 microscope to a computer for use with FiberChekPRO inspection software. See <a href="#">“Using the FVAi-2030 microscope with FiberChekPRO”</a> on page 4-1.
	USB Interfaces (2x) for connecting supported USB devices to FVAi-2030 microscope. See <a href="#">“Connecting and activating a supported USB device”</a> on page 2-21.
	VGA Interface for connecting the FVAi-2030 microscope to an external monitor.

## Powering the FVAi-2030 microscope on or off



### CAUTION

Use only the power adapter shipped with the FVAi-2030 microscope to power the device.

**Note:** This section describes the procedure for powering on the microscope for standalone use. For information about powering the microscope for use with the FiberChekPRO inspection software, see [“Using the FVAi-2030 microscope with FiberChekPRO” on page 4-1.](#)

- Step 1 Place the microscope on a flat, stable surface in a location close to an appropriate power source.
- Step 2 Connect the power adapter to the receptacle on the rear panel of the microscope and then to the power source.
- Step 3 Set the power switch on the rear panel to the ON position.

The LCD touchscreen initializes.

If the microscope is not connected to a computer via a USB-B connection (see [“Features” on page 2-2](#)), the Home screen appears.

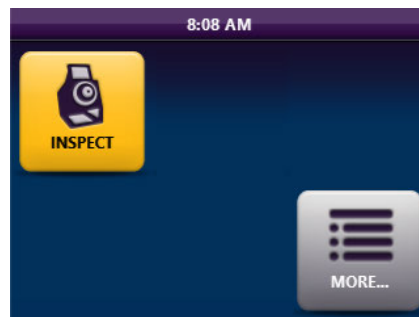

If the microscope is connected to a computer via a USB-B connection, select the **Home** tile to access the Home screen. For more information, see [“Navigating the Home screen” on page 2-6.](#)



- Step 4 To power off the microscope, set the power switch to the OFF position.

**Important:** Always use the power button to power the microscope off. Do not power off by disconnecting the power cable from either the device or the power source.

— End —

## Mounting fiber adapters and connectors

**Important:** Store fiber adapters in dust-proof containers while not installed on a microscope.

- Step 1 If present, unscrew the lens cap or fiber adapter from the adapter mount, and store it in a dust-proof container.
- Step 2 Place the required fiber adapter onto the mount, and finger-tighten the adapter to secure it. Do not over-tighten the adapter.
- Step 3 Power on the microscope, and access Live view on the LCD touchscreen (see [“Accessing Live view” on page 2-8](#)).
- Step 4 Clean the fiber connector to be inspected.
- Step 5 Ensure that the fiber connector is correctly oriented, and then insert it into the fiber adapter.
- Step 6 Ensure that the fiber end face is properly centered within the view.

Poor Centering

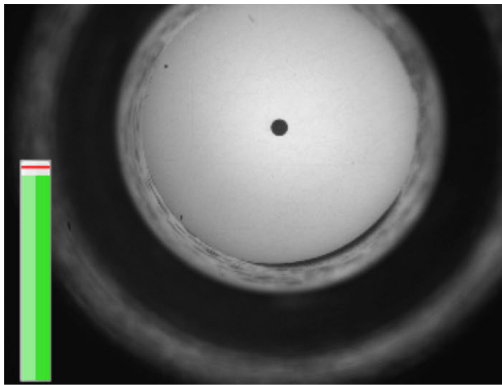

Good Centering

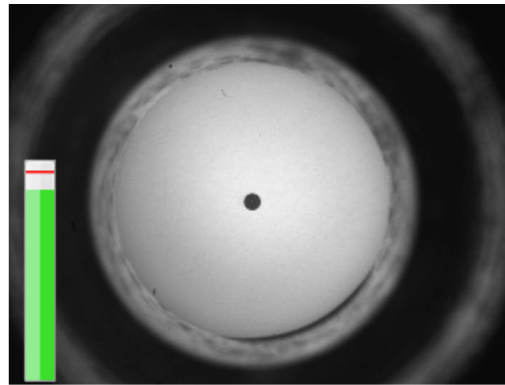

**Note:** The message Auto Focus Error: Unable to locate the fiber will appear when you attempt to use the **Autofocus** tool while the fiber end face is poorly centered.

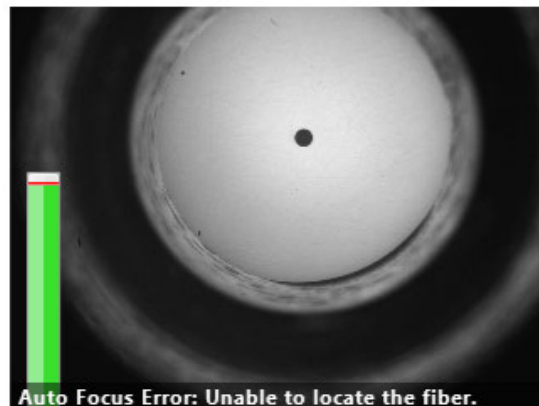

Step 7 If required, use the M5 hex screwdriver supplied with the microscope to adjust the vertical and horizontal position of the lens.

**Note:** You can use the Fiber Centering Limit setting and marker as a reference for the adjustment. For information, see [“Managing the Fiber Centering Limit setting and marker” on page 2-16.](#)

Insert the end of the M5 hex screwdriver into an adjustment pilot hole until it engages, and then carefully turn the screwdriver in either direction, referring to the touchscreen as the position of the lens changes.

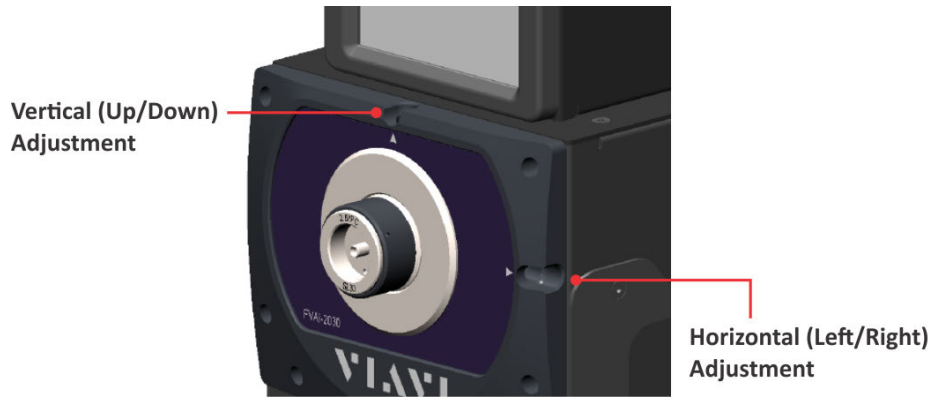

	<b>CAUTION</b>	<ul style="list-style-type: none"><li>• Use only the M5 hex screwdriver supplied with the microscope.</li><li>• Do not force the screwdriver beyond the adjustment limits.</li></ul>
--	----------------	--

— End —

## Navigating the Home screen

Use the Home screen during standalone operation of the microscope to access tools on the FVAi-2030 microscope ([Table 2-2 on page 2-7](#)).

**Note:** If touchscreen controls (such as tiles, menu options, and keyboard keys) do not respond as expected, you can calibrate the active areas of the touchscreen. See [“Calibrating the touchscreen” on page 2-20](#) for information.

Figure 2-2: FVAi-2030 Home screen

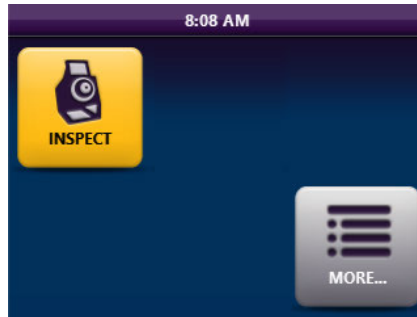

**Note:** If supported devices, such as a P5000i Digital Analysis Probe and/or an MP Series Optical Power Meter, are connected to the microscope via a USB connection (see [“Features” on page 2-2](#)), a tile for activating the supported device appears on the Home screen. Select the tile for the device to use the device with the microscope. See [“Connecting and activating a supported USB device” on page 2-21](#) for more information.

Figure 2-3: FVAi-2030 Home Screen example - connected USB devices

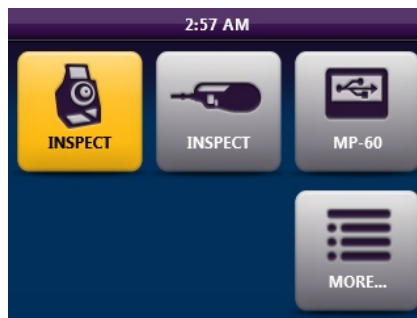

Table 2-2: FVAi-2030 Home screen tools



Tool	Description
	<p><b>Inspect</b> (FVAi-2030)</p> <p>Activates the FVAi-2030 microscope and accesses Live view for fiber inspection. See <a href="#">“Accessing Live view”</a> on page 2-8.</p>
	<p><b>More</b> (Home Screen menu, <a href="#">Figure 2-4</a>)</p> <p><b>RECALL IMAGE:</b> See <a href="#">“Recalling test results and images”</a> on page 3-7</p> <p><b>REVIEW OPM DATA:</b> See <a href="#">“Connecting and activating a supported USB device”</a> on page 2-21.</p> <p><b>SYSTEM SETTINGS:</b> See <a href="#">“Managing system settings”</a> on page 2-19</p> <p><b>USER INFO:</b> See <a href="#">“Managing user information”</a> on page 2-14</p> <p><b>OUTPUT:</b></p> <ul style="list-style-type: none"> <li>• During standalone operation, <b>OUTPUT:LOCAL</b> indicates local operation via the touchscreen.</li> <li>• While the microscope is connected to an external monitor via a VGA connection (<b>OUTPUT:VGA</b>), and/or to FiberChekPRO via a USB-B connection to the computer where FiberChekPRO is installed, select to toggle output mode for working with the microscope.</li> </ul> <p><b>Note:</b> While output mode is FiberChekPRO over a USB-B connection, select the <b>Home</b> tile on the LCD touchscreen to access the <b>Home</b> screen on the touchscreen. See <a href="#">“Powering the FVAi-2030 microscope on or off”</a> on page 2-3.</p>

Figure 2-4: Home Screen menu example



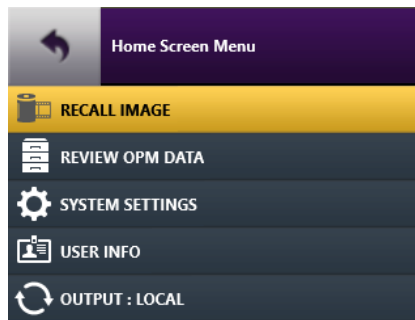

## Accessing Live view

During standalone operation of the microscope, the Live view on the touchscreen displays a live view of the fiber connector mounted on the fiber adapter and provides access to various fiber inspection and management tools.

**Note:** For information about Live view features available in FiberChekPRO, see the *FiberChekPRO Automated Fiber Inspection and Analysis Software User Manual*.

Step 1 On the Home screen, select **Inspect** to access Live view.

The following image shows that a fiber connector is mounted on the microscope and the Focus-quality meter is enabled.

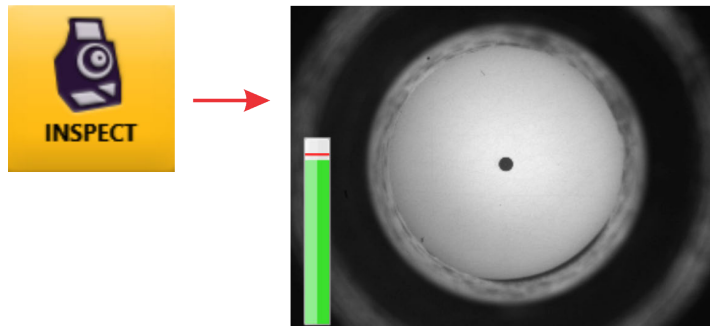

Step 2 Tap the touchscreen to access the Live view tools, and then select a tool (Table 2-3 on page 2-9).

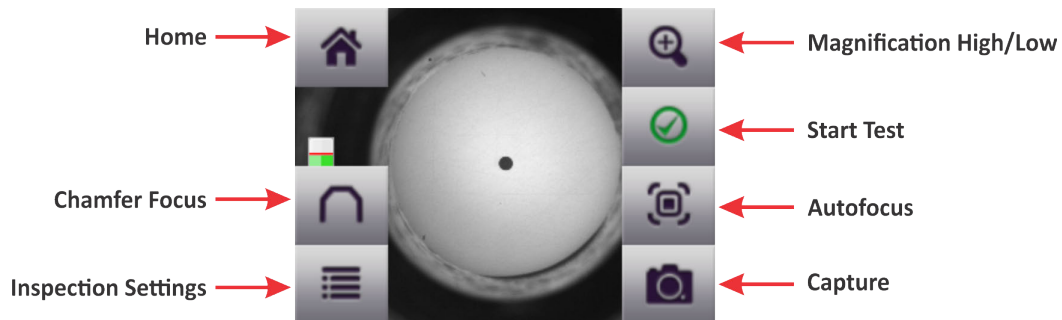

**Note:** While the microscope is connected to an external monitor and in Live View, the touchscreen displays only the Live view tools.

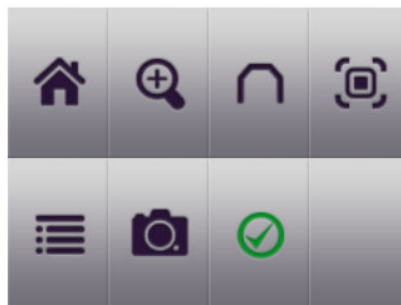

Table 2-3: Live view tools

Tool	Description
Home	Return to the Home screen (see “Navigating the Home screen” on page 2-6).
Magnification High/Low	Increase or decrease magnification of the image displayed on the touchscreen.
Start Test	See “Starting a Pass/Fail test from the FVAi-2030” on page 3-3. <b>Note:</b> For information about starting a Pass/Fail test with FiberChekPRO, see “Using the FVAi-2030 microscope with FiberChekPRO” on page 4-1.
Chamfer Focus	See “Viewing the fiber chamfer” on page 3-4. <b>Note:</b> For information about using FiberChekPRO to view the fiber chamfer, see “Using the FVAi-2030 microscope with FiberChekPRO” on page 4-1.
Autofocus	Automatically focus the view of the fiber end face on the touchscreen. <b>Note:</b> If configured in the microscope settings, selecting Autofocus will trigger a Pass/Fail test. See “Managing microscope settings” on page 2-15.
Inspection Settings menu	PROFILE: See “Applying a profile and an optical setting” on page 2-10.
	OPTICAL SETTING: See “Applying a profile and an optical setting” on page 2-10.
	CREATE NEW GROUP/CLOSE GROUP : <i>GROUP NAME</i> : See “Managing groups” on page 2-12.
	RECALL IMAGE <sup>1</sup> : See “Recalling test results and images” on page 3-7.
	USER INFO <sup>1</sup> : See “Managing user information” on page 2-14.
	MICROSCOPE SETTINGS: See “Managing microscope settings” on page 2-15.
	IMAGE SAVE OPTIONS: See “Managing image-save options” on page 2-18.
	SYSTEM SETTINGS <sup>1</sup> : See “Managing system settings” on page 2-19.
OUTPUT LOCAL <sup>1</sup> : See “Navigating the Home screen” on page 2-6.	
Capture	See “Capturing images” on page 3-5.

1. Also available on the Home Screen menu (see “Navigating the Home screen” on page 2-6).

— End —

## Applying a profile and an optical setting

The FVAi-2030 microscope provides factory-set analysis profiles and optical settings for use in Pass/Fail testing (Table 2-4). A profile defines Pass/Fail thresholds for a fiber type, while an optical setting defines the lighting and sizing calibration applied during a test.

Refer to Table 2-4 to ensure that the appropriate profile and optical setting for the fiber connector are applied before performing a test during standalone operation of the microscope.

**Table 2-4: Factory-set analysis profiles and optical settings**

With Analysis Profile...	Use Optical Setting...
FVAi-2030 SM 1.25 mm UPC (Polish detect)	FMAX-LC-SL35
FVAi-2030 SM 1.25 mm APC (Polish detect)	FMAX-LCA-SL35
FVAi-2030 SM 2.5 mm UPC (Polish detect)	FMAX-SC-SL30
FVAi-2030 SM 2.5 mm APC (Polish detect)	FMAX-SCA-SL30
FVAi-2030 MM50 1.25 mm UPC (Polish detect)	FMAX-LC-SL35
FVAi-2030 MM50 2.5 mm UPC (Polish detect)	FMAX-SC-SL30

**Note:** FiberChekPRO provides tools that let you create customized profiles (see “[Creating analysis profiles for the FVAi-2030 microscope](#)” on page 4-6) and optical settings. You can also manage factory-set and custom profiles and optical settings with FiberChekPRO, making them available on or removing them from the microscope as required. For information, including information about applying profiles and optical settings using FiberChekPRO, see the *FiberChekPRO Automated Fiber Inspection and Analysis Software User Manual*.

Step 1 In Live view, select **Inspection Settings**, and then do either of the following:

- Select **PROFILE** to access the profiles available on the microscope, select a profile, and then select **Back** to return to the **Inspection Settings** menu.



- Select **OPTICAL SETTINGS** to access the optical settings available on the microscope, select an optical setting, and then select **Back** to return to the **Inspection Settings** menu.

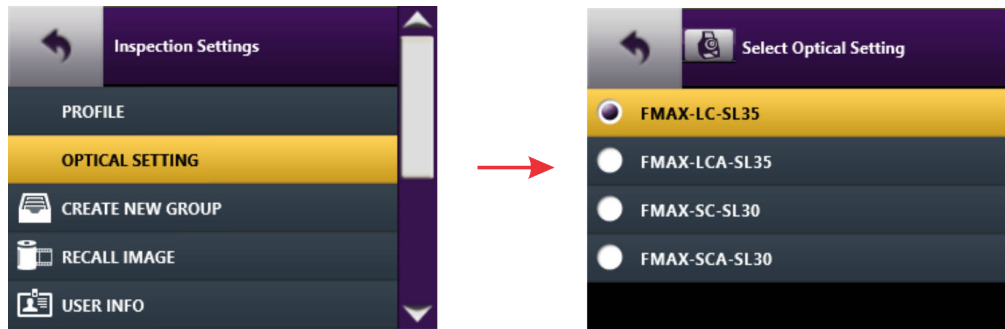

Step 2 Select another option on the **Inspection Settings** menu, or select **Back** to return to Live view.

— End —

## Managing groups

Use groups during standalone operation of the microscope to organize and manage Pass/Fail data and captured fiber images saved to the microscope. While a group is active, saved data and images are automatically added to that group.

You can create a group and set it as the active group, or set an existing group as the active group. Closing the active group allows you to save data and images without adding them to a group.

**Note:** For information about using and managing groups with FiberChekPRO, see the *FiberChekPRO Automated Fiber Inspection and Analysis Software User Manual*.

**Step 1** In Live view, select **Inspection Settings**, and then do one of the following:

- If the **CLOSE GROUP : GROUP NAME** option is available, select it to close the active group. The option label changes to **CREATE NEW GROUP**.

Select **Back** to return to Live view, or select **CREATE NEW GROUP** to set an active group.



**Note:** The **CREATE NEW GROUP** option is available only while no other group is active.

- If the **CREATE NEW GROUP** option is available, select it to access the on-screen keyboard, and then go to [Step 2](#).



**Step 2** To set the active group, type either a unique name for the group you want to create or the name of an existing group.

**Note:** The microscope provides a default group name (GROUP-001) that automatically increments. For example, if you create a group using the default group name GROUP-001 and then save data or images to it while it is active, the group name GROUP-002 is automatically provided as a option when you close GROUP-001 and select CREATE NEW GROUP. For information about changing the default group base name, see [“Managing image-save options” on page 2-18](#).

Step 3 Select **OK** to return to the **Inspection Settings** menu.

The option label changes to **CLOSE GROUP : GROUP NAME**, indicating that the specified group is active.

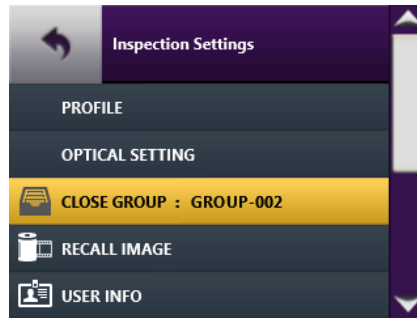

Step 4 Select another option, or select **Back** to return to Live view.

— End —

## Managing user information

During standalone operation of the microscope, you can add user information (for example, customer name, location, job ID, fiber ID, etc.) to help manage Pass/Fail data and fiber-analysis images saved to the microscope.

### Fiber ID Base parameter

By default, a fiber ID is assigned to saved data and images and appears with each recalled image (see [“Recalling test results and images” on page 3-7](#)). The fiber ID includes a prefix (base) and a value that increments as data and images are saved; for example FIBER-001, FIBER-002, and so on. The default fiber ID base is FIBER; however, you can change it as required when adding user information.

**Note:** For information about managing user information with FiberChekPRO, see the *FiberChekPRO Automated Fiber Inspection and Analysis Software User Manual*.

Step 1 In Live view, select **Inspection Settings**, and then select **USER INFO**.

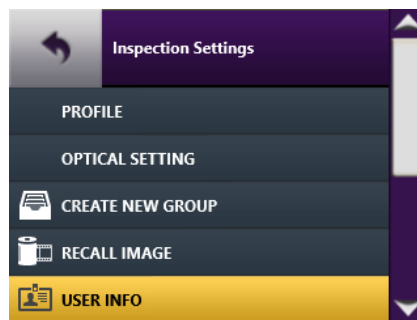

Step 2 On the **User Information** menu, scroll to and select an option to access an on-screen keyboard, type the information, and then click OK to return to the **User Information** menu.

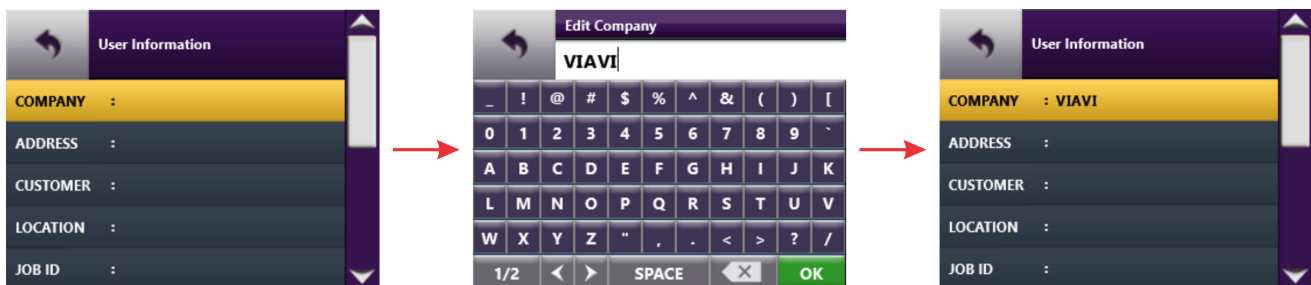

The specified information appears beside the option label.

Step 3 Repeat [Step 2](#) and [Step 3](#) as required.

Step 4 Select **Back** to return to the **Inspection Settings** menu.

Step 5 Select another option, or select **Back** to return to Live view.

— End —

## Managing microscope settings

Microscope settings let you specify operation parameters for the FVAi-2030 microscope.

**Note:** For information about managing microscope settings (i.e., device settings) with FiberChekPRO, see the *FiberChekPRO Automated Fiber Inspection and Analysis Software User Manual*.

Step 1 In Live view, select **Inspection Settings**, and then select **MICROSCOPE SETTINGS**.

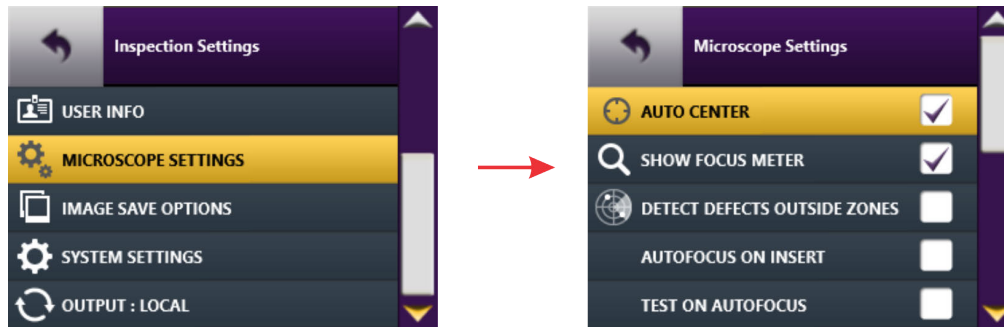

Step 2 Specify microscope settings as required.

Setting	Description
AUTOCENTER	Enable (default) or disable automatic centering of the fiber image in Live view.
SHOW FOCUS METER	Show (default) or hide the Focus-quality meter in Live view (see <a href="#">“Accessing Live view”</a> on page 2-8).
DETECT DEFECTS OUTSIDE ZONE	Enable or disable (default) detection of defects outside the largest inspection zone.
AUTOFOCUS ON INSERT	Enable or disable (default) auto-focusing of the fiber image in Live view as the fiber connector is mounted on the fiber adapter.
TEST ON AUTOFOCUS	Enable or disable (default) automatic Pass/Fail test when Autofocus is selected (see <a href="#">“Accessing Live view”</a> on page 2-8).
FIBER CENTERING LIMIT	Select to specify the fiber-centering-limit value using the on-screen keyboard. (Range = 1 to 999 $\mu\text{m}$ ; default = N/A.) See <a href="#">“Managing the Fiber Centering Limit setting and marker”</a> on page 2-16).
SHOW CENTERING LIMIT	Show or hide (default) the Show Centering Limit marker in Live view (see <a href="#">“Managing the Fiber Centering Limit setting and marker”</a> on page 2-16).
CHAMFER FOCUS OFFSET	Select to specify the chamfer focus offset value using the on-screen keyboard. (Range = 0 to 2000 $\mu\text{m}$ ; default = 275 $\mu\text{m}$ ). The offset value specified adjusts the focus on the chamfer view (see <a href="#">“Viewing the fiber chamfer”</a> on page 3-4).
DISPLAY BUTTON MODE	Select to toggle the display mode to TEST (default) or CAPTURE.
AUTOFOCUS CALIBRATION	Recalibrate autofocus <b>Important:</b> For use only at the direction and with the guidance of VIAVI support.
PASS/FAIL UNLOCK	Not Applicable

Step 3 Select **Back** to return to the **Inspection Settings** menu.

Step 4 Select another option, or select **Back** to return to Live view.

— End —



## Managing the Fiber Centering Limit setting and marker

The Fiber Centering Limit setting lets you define a centering limit for the fiber end face, which you can either enable or disable by showing or hiding, respectively, a marker in Live view (Figure 2-5). The marker indicates the position of the fiber end face relative to the defined centering limit. This is useful when centration limits are required for Pass/Fail tests, and provides a helpful reference when manually adjusting fiber centering (see “Mounting fiber adapters and connectors” on page 2-4).

Figure 2-5: Fiber Centering Limit marker displayed in Live view

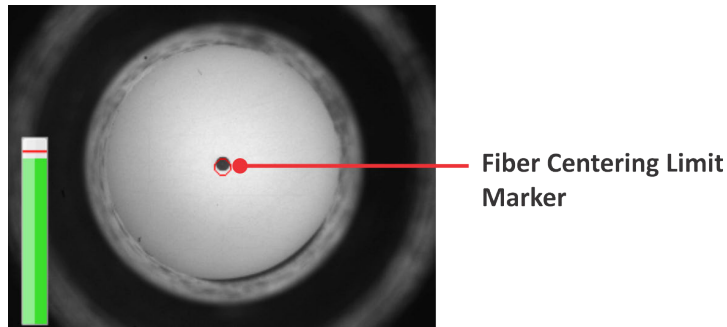

**Important:** While the specified fiber centering limit value is within the range of 1 to 999  $\mu\text{m}$  and the option to show the centering-limit marker is enabled, the message **Inspection Error: Fiber is too far out of center. Please re-center the fiber before testing** will appear on the touchscreen (Figure 2-6) when you attempt to start a Pass/Fail test on a fiber end face that is not aligned within the fiber-centering marker. Consequently, the test will not start.

Figure 2-6: Inspection Error message

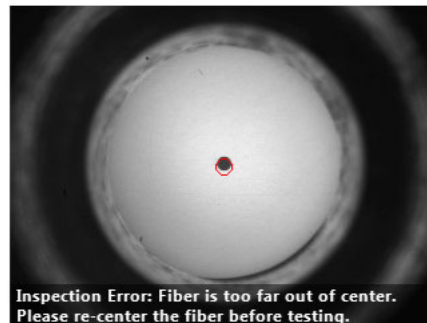

Step 1 In Live view, select **Inspection Settings**, select MICROSCOPE SETTINGS, and then select **FIBER CENTERING LIMIT** to access the on-screen keyboard.

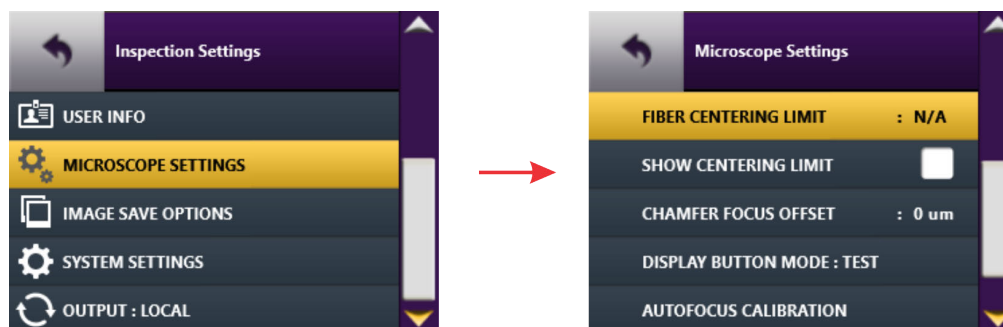

Step 2 Enter a value within the specified range (1 to 999), and then select **OK** to return to the **Microscope Settings** menu.

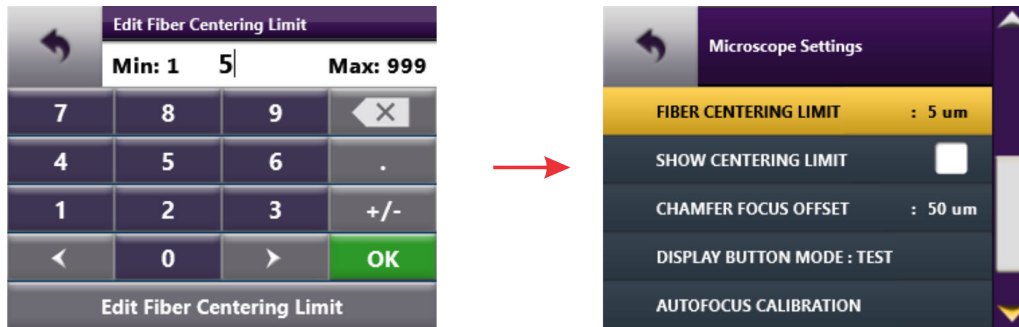

**Note:** Clearing the current value and returning to the **Microscope Settings** menu without specifying another value automatically sets the value to N/A.

Step 3 Optionally, enable or disable **SHOW CENTERING LIMIT**.

**Notes:**

- While **SHOW CENTERING LIMIT** is disabled, the specified fiber-centering limit (from 1 to 999) is not applied.
- While the fiber-centering limit value is N/A, the marker will not be shown even while **SHOW CENTERING LIMIT** is enabled.

Step 4 Select **Back** to return to the **Inspection Settings** menu, and then select **Back** to return to Live view.

— End —

## Managing image-save options

Step 1 In Live view, select **Inspection Settings**, and then select **IMAGE SAVE OPTIONS**.



Step 2 Specify settings as required.

Settings	Description
FIBER ID BASE	Select to edit the default fiber-ID prefix (base) using the on-screen keyboard. For more information, see <a href="#">“Managing user information” on page 2-14</a> .
GROUP NAME BASE	Select to edit the default group-name prefix (base) using the on-screen keyboard. For more information, see <a href="#">“Managing groups” on page 2-12</a> .
VERIFY NAME BEFORE SAVE	Select to confirm or change the fiber ID prefix before manually saving Pass/Fail test results or a captured fiber-analysis image.
ONE BUTTON SAVE	Select to enable manual save of Pass/Fail test results and captured fiber-analysis images without requiring name verification.
SAVE RESULTS IF PASS	Select to enable Pass results to be automatically saved after a Pass/Fail test.

**Note:** The save options **VERIFY NAME BEFORE SAVE**, **ONE BUTTON SAVE**, and **SAVE RESULTS IF PASS** are mutually exclusive. For example, selecting **ONE BUTTON SAVE** and then selecting **SAVE RESULTS IF PASS** automatically disables **ONE BUTTON SAVE**.

Step 3 Select **Back** to return to the **Inspection Settings** menu.

Step 4 Select another option, or select **Back** to return to Live view.

— End —

## Managing system settings

System settings include parameters such as language, date, time, and date and time formats, which are applied to information saved with Pass/Fail test results and saved images. Also included are tools for calibrating the touchscreen and retrieving system/device information

Step 1 Do one of the following:

- On the Home screen, select **More**, and then select **System Settings** on the **Home Screen** menu (see [“Navigating the Home screen” on page 2-6](#)).
- In Live view, select **Inspection Settings**, and then select **System Settings** on the **Inspection Settings** menu (see [“Accessing Live view” on page 2-8](#)).

Step 2 On the **System Settings** menu, scroll to and select an option, or select **Back** to return to the **Home Screen** or **Inspections Settings** menu.

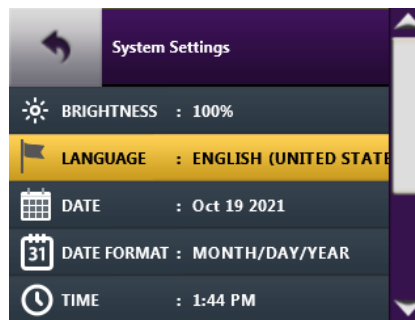

Option	Description
BRIGHTNESS	Set the brightness of the touchscreen.
LANGUAGE	Select the interface language for the microscope.
DATE	Set the date
DATE FORMAT	Set the date format
TIME	Set the time
TIME FORMAT	Set the time format
TOUCHSCREEN CALIBRATION	See <a href="#">“Calibrating the touchscreen” on page 2-20</a>
SYSTEM INFORMATION	Retrieve the following details for the FVAi-2030 microscope: <ul style="list-style-type: none"> <li>• Device ID</li> <li>• Serial Number</li> <li>• Board Revision</li> <li>• Firmware Version</li> <li>• LCD Revision</li> <li>• Uptime</li> </ul>

— End —

## Calibrating the touchscreen

If required, you can calibrate the active areas of the touchscreen to improve responsiveness.

- Step 1 Access the **System Settings** menu (see “Managing system settings” on page 2-19), and then select **TOUCHSCREEN CALIBRATION**.

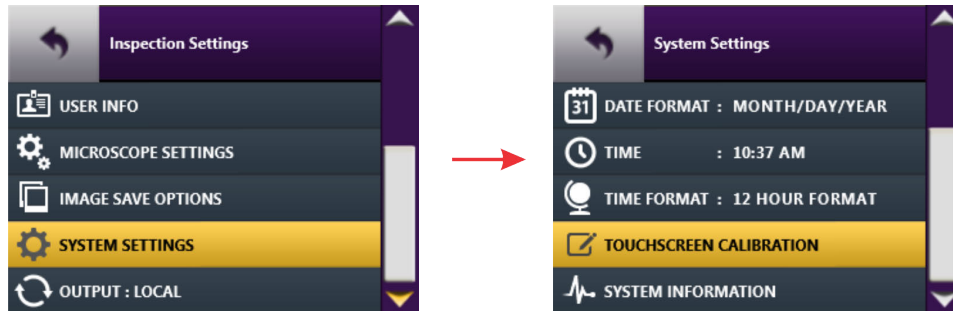

The Touchscreen Calibration view, which consists of a white background with a small, red marker in the top corner, appears.

- Step 2 Tap the marker to reveal an additional marker in another area of the touchscreen, and repeat until a red marker appears in the center.

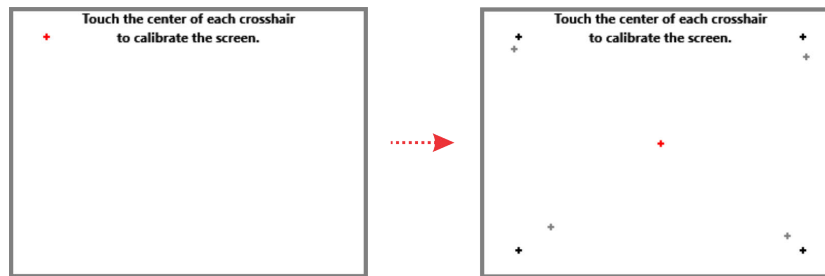

- Step 3 Tap the center red marker to view the results (PASS or FAIL) of the calibration.

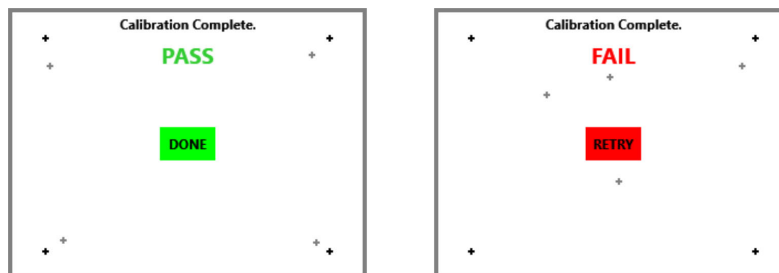

- Step 4 If calibration is successful, select **DONE** to return to the **System Settings** menu. If calibration fails, select **RETRY** to repeat the procedure.

**Note:** If the calibration operation fails repeatedly, power off the microscope to retain the current calibration settings. You can power the microscope on and continue using it, or you can contact your VIAVI representative for support.

- Step 5 Select **Back** to return to the **Inspection Settings** menu.

- Step 6 Select another option, or select **Back** to return to Live view.

— End —

## Connecting and activating a supported USB device

You can use with a P5000i Digital Analysis Probe and/or an MP Series Optical Power Meter with the FVAi-2030 microscope in standalone mode by connecting the device to a USB port at the rear of the microscope (see “Features” on page 2-2). When the microscope discovers the device, a tile for the device appears on the Home screen.

Figure 2-7: FVAi-2030 Home screen example - connected USB devices



### Activating a P5000i probe

**Note:** For information about operating a P5000i probe, including using the device with the FiberChekPRO inspection software (via the FVAi-2030 microscope or a direct connection to a computer), see the *P5000i Digital Analysis Probe Getting Started Guide, ZP-PKG-0574*, or the *FiberChekPRO Automated Fiber Inspection and Analysis Software User Manual*.

Step 1 Select the **INSPECT** tile for the probe to access Live view.

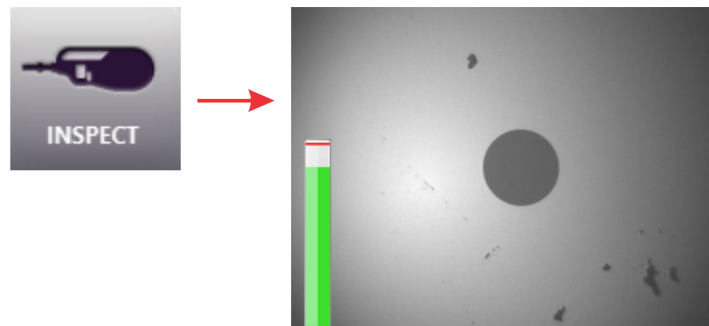

Step 2 Tap the touchscreen to access the Live view tools for the probe.

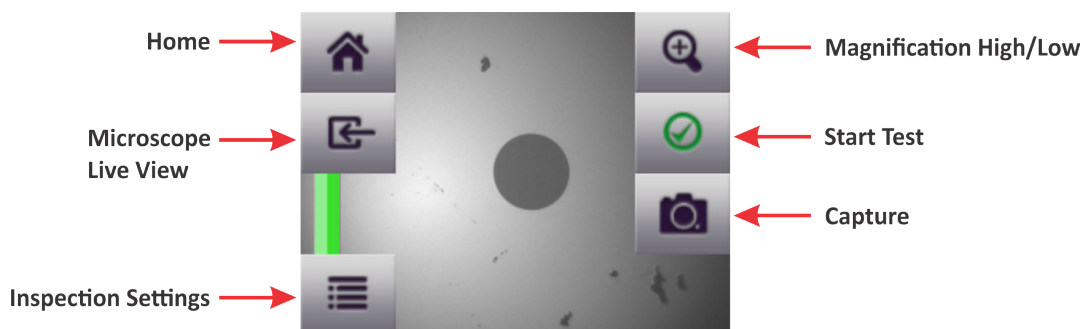

Live View Tool	Description
Home	Return to the Home screen (see <a href="#">Figure 2-7 on page 2-21</a> ).
Magnification High/Low	Increase or decrease magnification of the image displayed on the touchscreen.
Microscope Live View	Return to the FVAi-2030 microscope Live view.
Start Test	See <a href="#">“Starting a Pass/Fail test from the FVAi-2030” on page 3-3</a> . <b>Note:</b> For information about starting a Pass/Fail test with the FiberChekPRO inspection software, see <a href="#">“Using the FVAi-2030 microscope with FiberChekPRO” on page 4-1</a> .
Capture	See <a href="#">“Capturing images” on page 3-5</a> .
Inspection Settings menu (P5000i probe)	PROFILE: See <a href="#">“Applying a profile and an optical setting” on page 2-10</a> . <b>Note:</b> FVAi-2030 profiles are not compatible with the P5000i probe. Use the FiberChekPRO inspection software to load compatible profiles to the microscope. See the <i>P5000i Digital Analysis Probe Getting Started Guide</i> for information.
	TIP: See <a href="#">“Applying a profile and an optical setting” on page 2-10</a> . <b>Note:</b> Ensure that the tip setting you want to use is available on the P5000i probe. See the <i>P5000i Digital Analysis Probe Getting Started Guide</i> for information.
	CREATE NEW GROUP/CLOSE GROUP : <i>GROUP NAME</i> : See <a href="#">“Managing groups” on page 2-12</a> .
	RECALL IMAGE: See <a href="#">“Recalling test results and images” on page 3-7</a> .
	USER INFO: See <a href="#">“Managing user information” on page 2-14</a> .
	PROBE SETTINGS: <ul style="list-style-type: none"> <li>• AUTO CENTER</li> <li>• DEVICE BUTTON</li> <li>• SHOW FOCUS METER</li> <li>• DETECT DEFECTS OUTSIDE ZONES</li> <li>• FIBER CENTERING LIMIT</li> </ul>
	IMAGE SAVE OPTIONS: See <a href="#">“Managing image-save options” on page 2-18</a> .
	SYSTEM SETTINGS: See <a href="#">“Managing system settings” on page 2-19</a> .
	OUTPUT LOCAL: See <a href="#">“Navigating the Home screen” on page 2-6</a> .

— End —

## Activating an MP Series optical power meter

**Note:** The information in this section is based on an MP-80 power meter. Details might not apply to a different MP Series power meter. For information about operating an MP Series power meter, including using the device with the FiberChekPRO inspection software (via the FVAi-2030 microscope or a direct connection to a computer), see the *FiberChekPRO Automated Fiber Inspection and Analysis Software User Manual*.

- Select the tile for the power meter to access the meter tools.

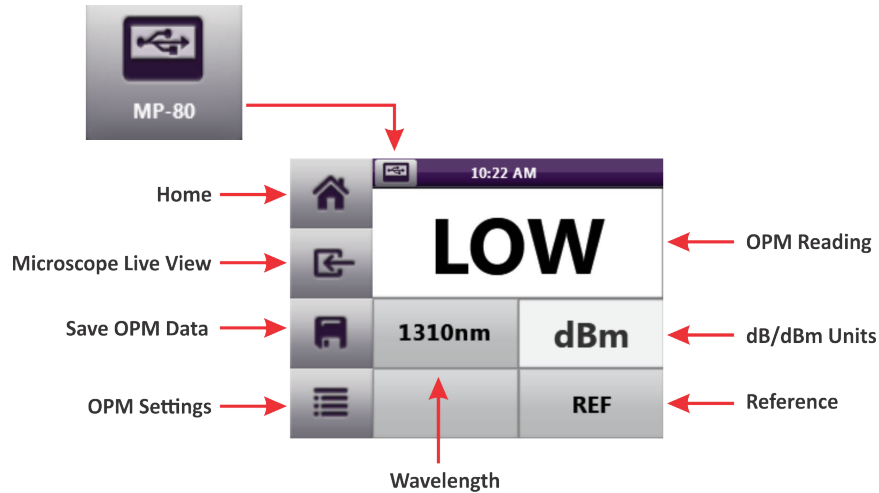

Live View Tool	Description
Home	Return to the Home screen (see <a href="#">Figure 2-7 on page 2-21</a> ).
Microscope Live View	Return to the FVAi-2030 microscope Live view.
Power Reading	OPM power reading
Save	Save OPM data
Units	Toggle setting to dB, dBm, or pW unit of measurement <b>Note:</b> The pW unit of measurement is available only while the ENABLE WATTS DISPLAY setting is enabled.
OPM Settings menu	EDIT WAVELENGTH TABLE
	REVIEW OPM DATA: Select to access and manage saved OPM data
	ENABLE WATTS DISPLAY: Enable availability of the pW unit of measurement.
	ENABLE OPM + IMAGE LINK: Enable or disable OPM + IMAGE LINK feature
	SYSTEM SETTINGS: See <a href="#">“Managing system settings” on page 2-19</a> .
	USER INFO: See <a href="#">“Managing user information” on page 2-14</a> .
OUTPUT LOCAL: See <a href="#">“Navigating the Home screen” on page 2-6</a> .	
Wavelength	Select to set wavelength for power measurements.
Reference	Select to obtain a reference measurement.

— End —





## 3 Fiber inspection during standalone operation

This section covers the following information:

- [“Requirements for Pass/Fail tests” on page 3-2](#)
- [“Starting a Pass/Fail test from the FVAi-2030” on page 3-3](#)
- [“Viewing the fiber chamfer” on page 3-4](#)
- [“Capturing images” on page 3-5](#)
- [“Recalling test results and images” on page 3-7](#)

## Requirements for Pass/Fail tests

Pass/Fail tests inspect fiber connectors against preconfigured pass criteria for the active analysis profile.

**Note:** For information about viewing the pass criteria for analysis profiles, see the *FiberChekPRO Automated Fiber Inspection and Analysis Software User Manual*.

**Table 3-1: Before you begin a Pass/Fail test**

Ensure that...	See...
A cleaned fiber connector is properly connected to the microscope.	<a href="#">"Mounting fiber adapters and connectors" on page 2-4</a>
A live image of the fiber connector is displayed on the touchscreen.	<a href="#">"Accessing Live view" on page 2-8</a>
The correct profile and optical setting are applied.	<a href="#">"Applying a profile and an optical setting" on page 2-10</a>
If required, the group that you want to add saved results to is active on the microscope.	<a href="#">"Managing groups" on page 2-12</a>
If required, user information you want to appear with saved results and images is specified.	<a href="#">"Managing user information" on page 2-14</a>
Additional settings are specified as required.	<ul style="list-style-type: none"> <li>• <a href="#">"Managing microscope settings" on page 2-15</a></li> <li>• <a href="#">"Managing image-save options" on page 2-18</a></li> <li>• <a href="#">"Managing system settings" on page 2-19</a></li> </ul>

## Starting a Pass/Fail test from the FVAi-2030

**Note:** Pass/Fail test results saved to the microscope cannot be accessed via FiberChekPRO. If you require use of FiberChekPRO to generate reports and further manage test results, connect the microscope to a computer where FiberChekPRO is installed (see “Connecting to FiberChekPRO” on page 4-2) and use FiberChekPRO to perform the test.

- Step 1 Review “Requirements for Pass/Fail tests” on page 3-2.
- Step 2 In Live view, refer to the Focus-quality meter (if displayed) to determine whether the image quality is suitable for inspection, and apply any adjustments if required.
- Step 3 Tap the touchscreen to access the inspection tools (see “Accessing Live view” on page 2-8).
- Step 4 Select **Start Test**.



When the test is completed, analysis details appear on the touchscreen.

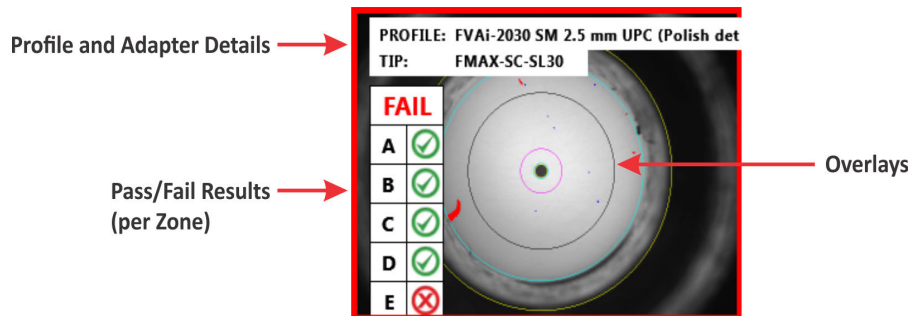

**Note:** For information about zones and overlays, see the *FiberChekPRO Automated Fiber Inspection and Analysis Software User Manual*.

- Step 5 Tap the touchscreen to display tools for working with the test results and accessing the **Inspection Settings** menu.

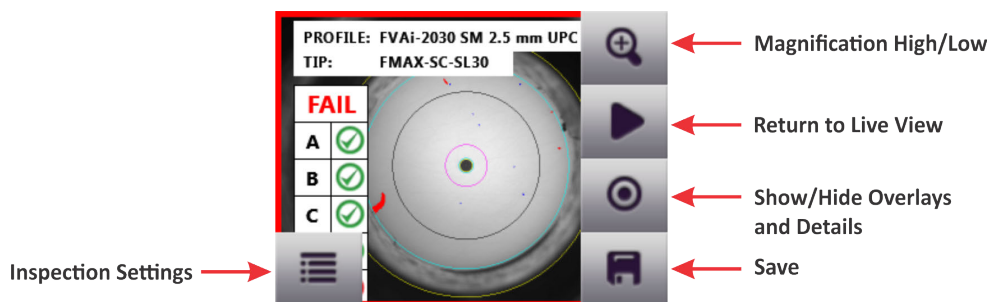

- Step 6 Optionally, select **Save** to save the results to the microscope.
- If a group is active, the saved results are added to it. For information about accessing test results saved to the microscope, see “Recalling test results and images” on page 3-7.

— End —

## Viewing the fiber chamfer

In Live view, you can visually analyze the fiber chamfer by using the **Chamfer Focus** tool to bring the fiber chamfer into focus (Figure 3-1). The **CHAMFER FOCUS OFFSET** setting (see “Managing microscope settings” on page 2-15) lets you control the amount by which the chamfer is brought into focus each time you apply the **Chamfer Focus** tool. Setting a lower value applies less focus than a higher value, letting you bring the fiber chamfer into focus more gradually.

**Note:** As **Chamfer Focus** is applied, the view of the fiber end face becomes less focused.

Figure 3-1: Chamfer focus application (Live view tools hidden)

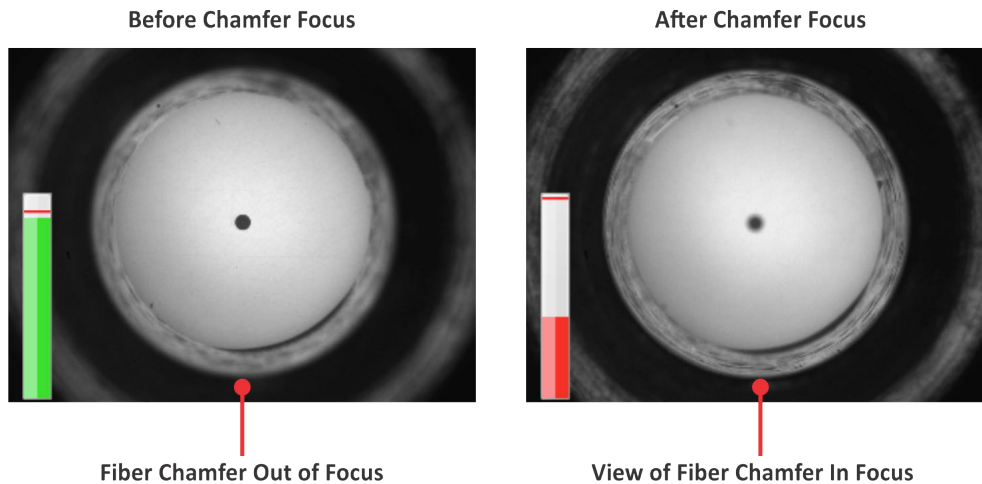

Step 1 Review “Requirements for Pass/Fail tests” on page 3-2.

Step 2 In Live view, tap the touchscreen to access the Live view tools.

Step 3 Select **Chamfer Focus** to bring the chamfer into focus, repeating until the focus you require is obtained.



**Note:** Successive applications of the tool after obtaining a focused view of the chamfer will bring the chamfer out of focus.

Step 4 Do any of the following:

- Tap the touchscreen to hide the Live view tools, and then tap again to show them.
- Capture an image (see “Capturing images” on page 3-5).
- Select **Autofocus** to reset the focus to the fiber end face.

— End —

## Capturing images

In Live view, you can capture images of the fiber end face and save them to the microscope and recall them for later analysis. For information about accessing images saved to the microscope, see [“Recalling test results and images” on page 3-7](#)

**Note:** Captured images saved to the microscope cannot be accessed via FiberChekPRO. If you require use of FiberChekPRO to manage images, connect the microscope to a computer where FiberChekPRO is installed and use FiberChekPRO to capture the image (see [“Using the FVAi-2030 microscope with FiberChekPRO” on page 4-1](#)),.

Step 1 Review [“Requirements for Pass/Fail tests” on page 3-2](#).

Step 2 In Live view, tap the touchscreen to access the inspection tools (see [“Accessing Live view” on page 2-8](#)).

Step 3 Select **Capture**.



The captured image appears.

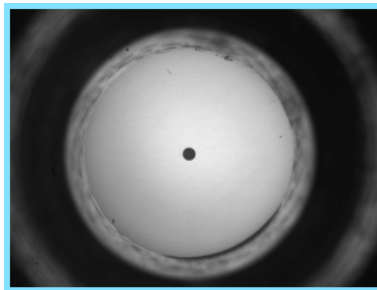

Step 4 Tap the touchscreen to display tools for working with the image and accessing the **Inspection Settings** menu.

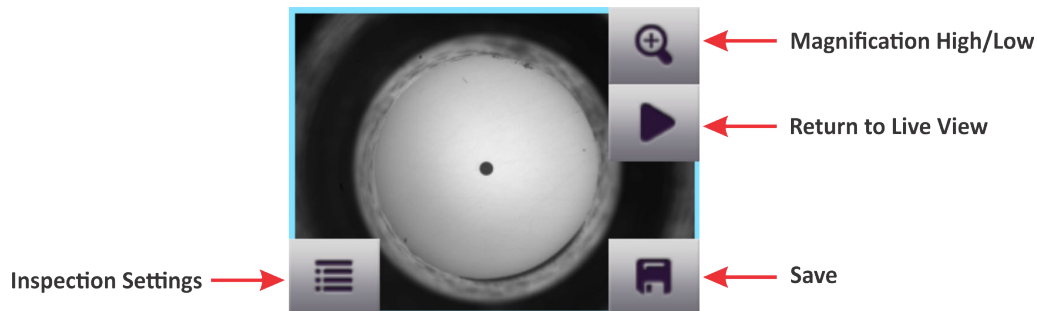

Step 5 Select **Save** to save the captured image to the microscope.

If a group is active, the saved image is added to it, and the group name and fiber ID appears on the image.

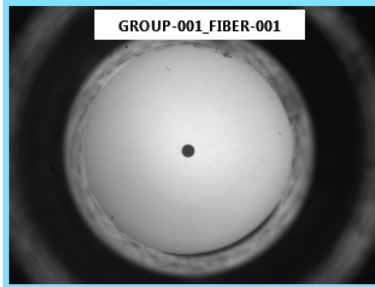

Step 6 Tap the touchscreen to access the tools, and then select **Return To Live View**.

— End —

## Recalling test results and images

You can access Pass/Fail test results and images saved to the microscope.

Step 1 Do one of the following:

- On the Home screen, select **More**, and then select **RECALL IMAGE** on the **Home Screen** menu (see “Navigating the Home screen” on page 2-6).
- In Live view, select **Inspection Settings**, and then select **RECALL IMAGE** on the **Inspection Settings** menu (see “Accessing Live view” on page 2-8).

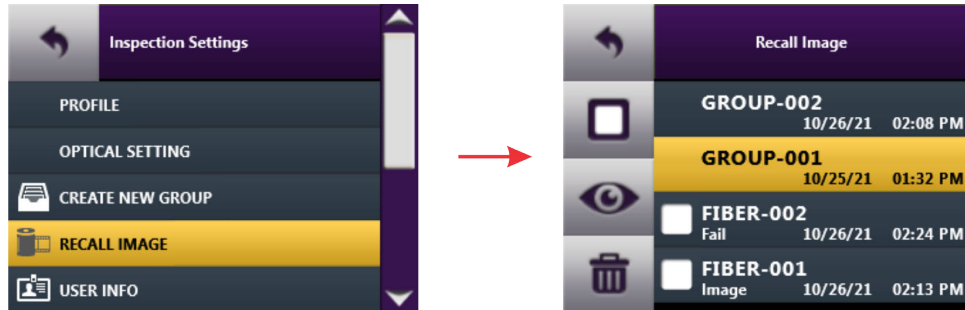

The **Recall Image** menu lists the groups that saved test results and/or images were added to, as well as test results and/or images saved but not added to a group.

Step 2 Do one of the following:

- Individually select the check box for each test result and/or image you want to access, or select the **Select All** check box. Test results are indicated by either the Pass or Fail label, and images are indicated by the label Image.

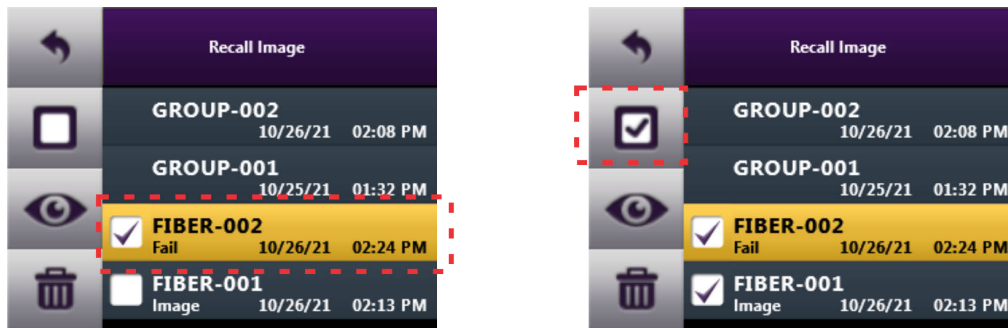

- Select a group to access the test results and/or images it contains.

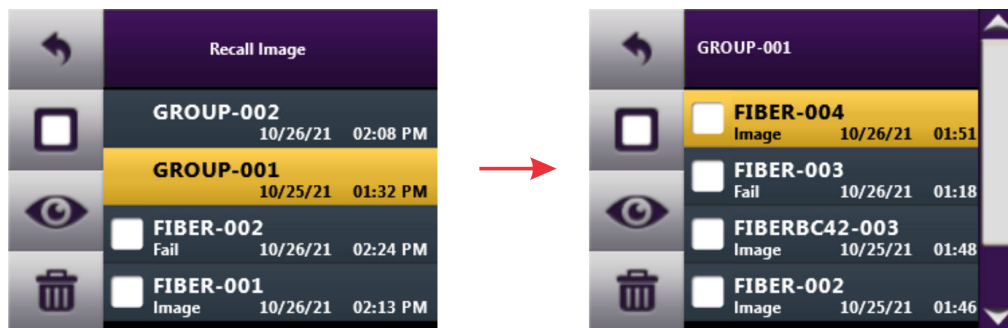

You can individually select test results and/or images in the group, or select **Select All**.

Step 3 Do any of the following:

- To view selected test results and/or images, go to [Step 4](#).
- To delete selected test results and/or images, select **Delete**, select **CONFIRM** to confirm the action, and then go to [Step 6](#).



Step 4 Select **View**.



The first selected test result and/or image is displayed, along with related tools.

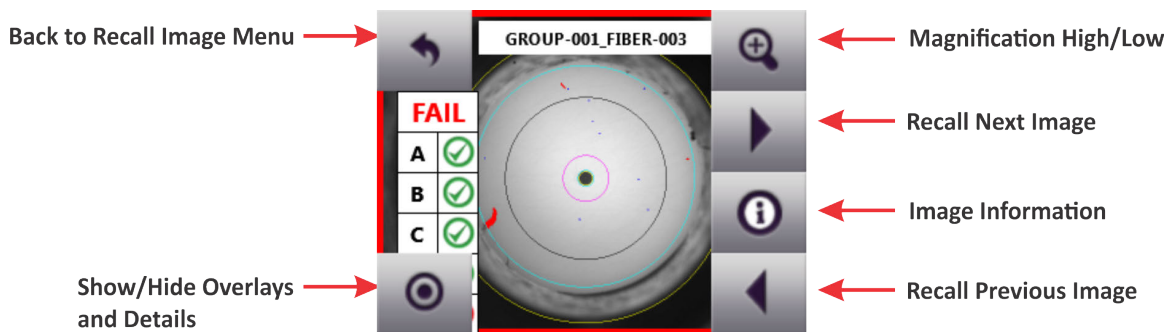

**Note:** **Image Information** shows the date and time the test results or image was saved, focus meter setting, microscope type, and profile and optical setting applied.

Step 5 Select **Back** to return to the **Recall Image** menu.

Step 6 Select another option, or select **Back** to return to the **Home Screen** or **Inspection Settings** menu.

— End —





## 4 Using the FVAi-2030 microscope with FiberChekPRO

This section covers the following information:

- “Connecting to FiberChekPRO” on page 4-2
- “Performing Pass/Fail tests and generating reports” on page 4-3
- “Viewing the fiber chamfer with FiberChekPRO” on page 4-5
- “Creating analysis profiles for the FVAi-2030 microscope” on page 4-6

**Note:** You can download the FiberChekPRO inspection software from <http://fcpro.updatemyunit.net/> and install it on multiple computers at no additional cost. For detailed information about using the software, refer to the *FiberChekPRO Automated Fiber Inspection and Analysis Software User Manual*, ZP-SW-00071, which you can access from the FiberChekPRO **Help** menu.

## Connecting to FiberChekPRO

You can use the FVAi-2030 microscope with the FiberChekPRO inspection software via a USB connection to the computer where the software is installed (see [“Features” on page 2-2](#)). You can then perform Pass/Fail tests, view test results, generate fiber inspection reports, and manage inspection and microscope settings.

You can also update the microscope firmware or perform a system reset when required. For information, see [“Firmware update” on page A-1](#) and [“System reset” on page B-1](#).

Step 1 Start FiberChekPRO.

Step 2 Connect a USB cable to the USB interface on the microscope (see [“Features” on page 2-2](#)) and then to the computer.

Step 3 Power on the microscope (see [“Powering the FVAi-2030 microscope on or off” on page 2-3](#)).

The LCD touchscreen on the microscope initializes, and FiberChekPRO automatically detects the microscope.

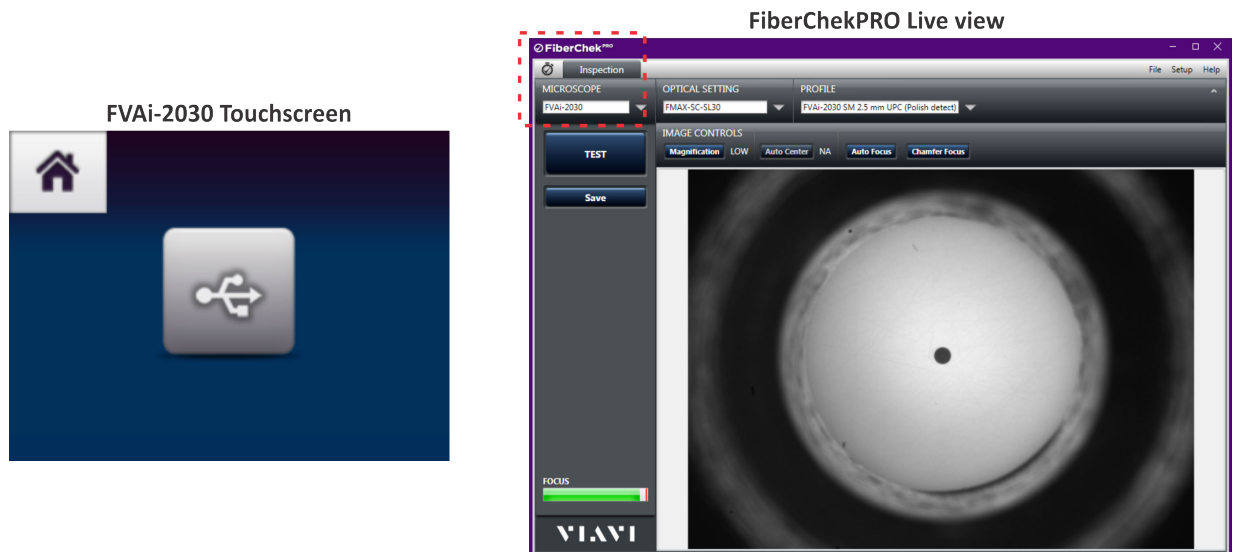

**Note:** While the microscope is connected to the FiberChekPRO inspection software, you can toggle the output mode so that you can use either the software or the LCD touchscreen. Select the **Home** tile on the touchscreen, access the **Home Screen** menu, and then select **OUTPUT LOCAL** on the **Inspection Settings** menu. For information, see [“Navigating the Home screen” on page 2-6](#).

— End —

## Performing Pass/Fail tests and generating reports

FiberChekPRO lets you generate a fiber inspection report using the results of a Pass/Fail test performed with FiberChekPRO. This report provides a detailed summary of the test performed during an analysis. The report also includes the date and time that the test was performed, detailed fiber information and, when available, information such as company name, location, and operator information.

**Note:** The date and time information on a report reflects the date and time that the Pass/Fail test was performed. The format used for the date reflects the system settings on the computer where FiberChekPRO software is installed.

You generate a report by saving the inspection data immediately after performing a Pass/Fail test using FiberChekPRO. By default, reports are saved to HTML format.

**Note:** Refer to the *FiberChekPRO Automated Fiber Inspection and Analysis Software User Manual* for detailed information about using the tools of the software to analyze and manage test results, as well as information about specifying the format (HTML or PDF) reports are saved to.

- Step 1 Review [“Requirements for Pass/Fail tests”](#) on page 3-2.
- Step 2 Connect the microscope to FiberChekPRO (see [“Connecting to FiberChekPRO”](#) on page 4-2).
- Step 3 In FiberChekPRO, refer to the Focus-quality meter to ensure that live image is suitable for inspection.

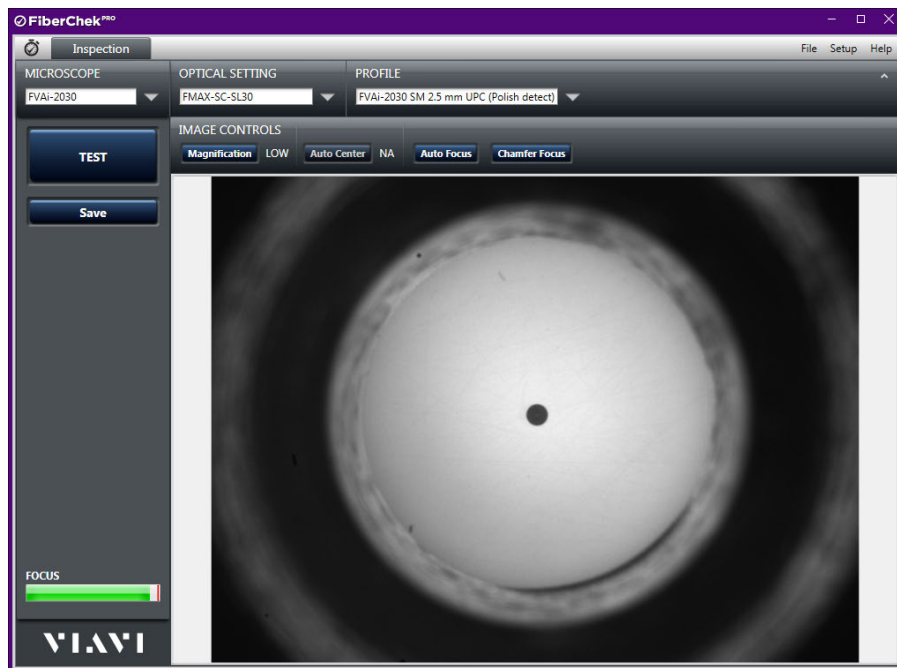

- Step 4 Click **TEST** to start the test.

When the test is completed, the results are automatically displayed with overlays.

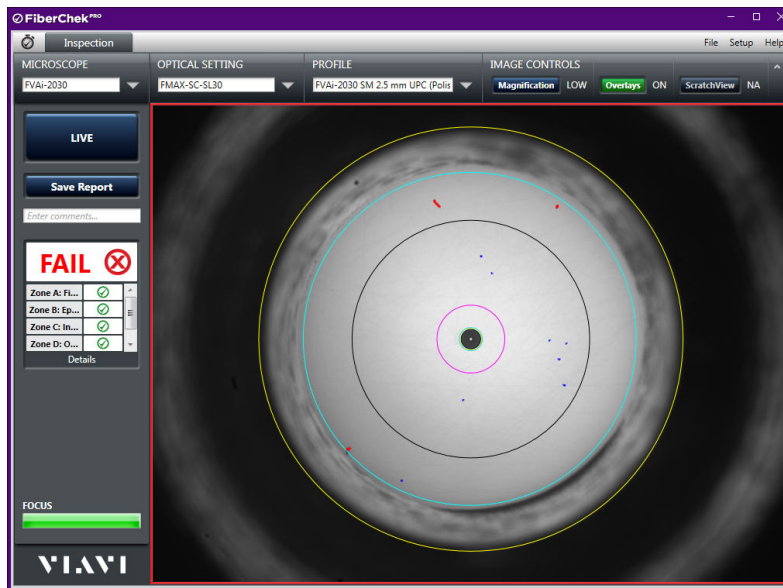

Step 5 Optionally, click **Overlays** to hide or show the overlays as needed.

Step 6 Optionally, click **Save Report**, and then do the following to generate a report:

- In the **Save As** dialog, type a name for the report in the **Name** field, and then click **Save** to the report to the default folder on the computer where FiberChekPRO is installed, or navigate to another location.

The default folder is located at C:\Users\userName\Documents\Viavi\FiberChekPRO\Archives\FVAi-2030\_deviceID

The report is generated and appears in a separate window.

Step 7 Close the report window when you have finished viewing the information.

You can access the saved report later for viewing or sharing by accessing the folder where the file containing the report is located.

Step 8 Select **LIVE** to return to Live view.

— End —

## Viewing the fiber chamfer with FiberChekPRO

You can visually analyze the fiber chamfer by using the **Chamfer Focus** tool to bring the fiber chamfer into focus (Figure 4-1). The **Chamfer Focus Offset** setting lets you control the amount by which the chamfer is brought into focus each time you apply the **Chamfer Focus** tool. Setting a lower value applies less focus than a higher value, letting you bring the fiber chamfer into focus more gradually.

### Notes:

- The **Chamfer Offset** setting is available via the **Device Settings** option for the microscope. For information about accessing the **Device Settings** option, see the *FiberChekPRO Automated Fiber Inspection and Analysis Software User Manual*.
- As **Chamfer Focus** is applied, the view of the fiber end face becomes less focused.

Figure 4-1: Chamfer Focus application.

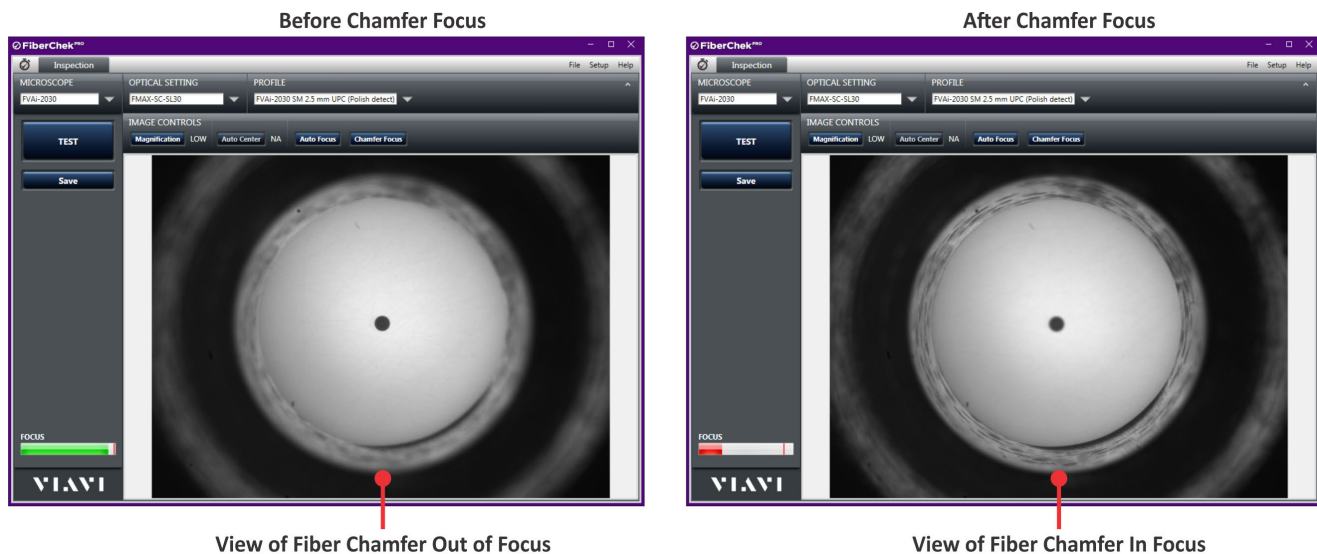

View of Fiber Chamfer Out of Focus

View of Fiber Chamfer In Focus

- Step 1 Review [“Requirements for Pass/Fail tests”](#) on page 3-2.
- Step 2 Connect FiberChekPRO to the microscope (see [“Connecting to FiberChekPRO”](#) on page 4-2).
- Step 3 In FiberChekPRO, refer to the Focus-quality meter to ensure that the live image is suitable for inspection.
- Step 4 Select **Chamfer Focus** on the **Image Controls** toolbar to bring the chamfer into focus, repeating until the focus you require is obtained.

**Note:** Successive applications of the tool after obtaining a focused view of the chamfer will bring the chamfer out of focus.

- Step 5 Optionally, do any of the following:

- Select **Save**, and then navigate to the folder when you want to save the image.

**Note:** Refer to the *FiberChekPRO Automated Fiber Inspection and Analysis Software User Manual* for detailed information about using the tools of the software to save and manage images.

- Select **Auto Focus** to reset the focus to the fiber end face.

— End —

## Creating analysis profiles for the FVAi-2030 microscope

In addition to providing factory-installed profiles specific to the FVAi-2030 microscope, FiberChekPRO provides tools to help you create profiles to meet your fiber-inspection requirements.

You can create either a new profile or a customized copy of an existing FVAi-2030 profile.

**Note:** For detailed information about using FiberChekPRO to manage analysis profiles, see the *FiberChekPRO Automated Fiber Inspection and Analysis Software User Manual*.

Step 1 Connect the microscope to FiberChekPRO (see “Connecting to FiberChekPRO” on page 4-2).

Step 2 On the **Setup** menu, select the microscope.

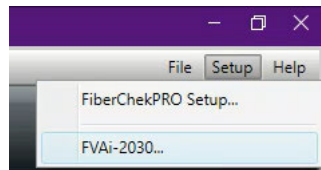

Step 3 On the **Setup** page for the microscope, select **Analysis Profiles** in the navigation pane to access the lists (**Available** and **On Device**) of analysis profiles.

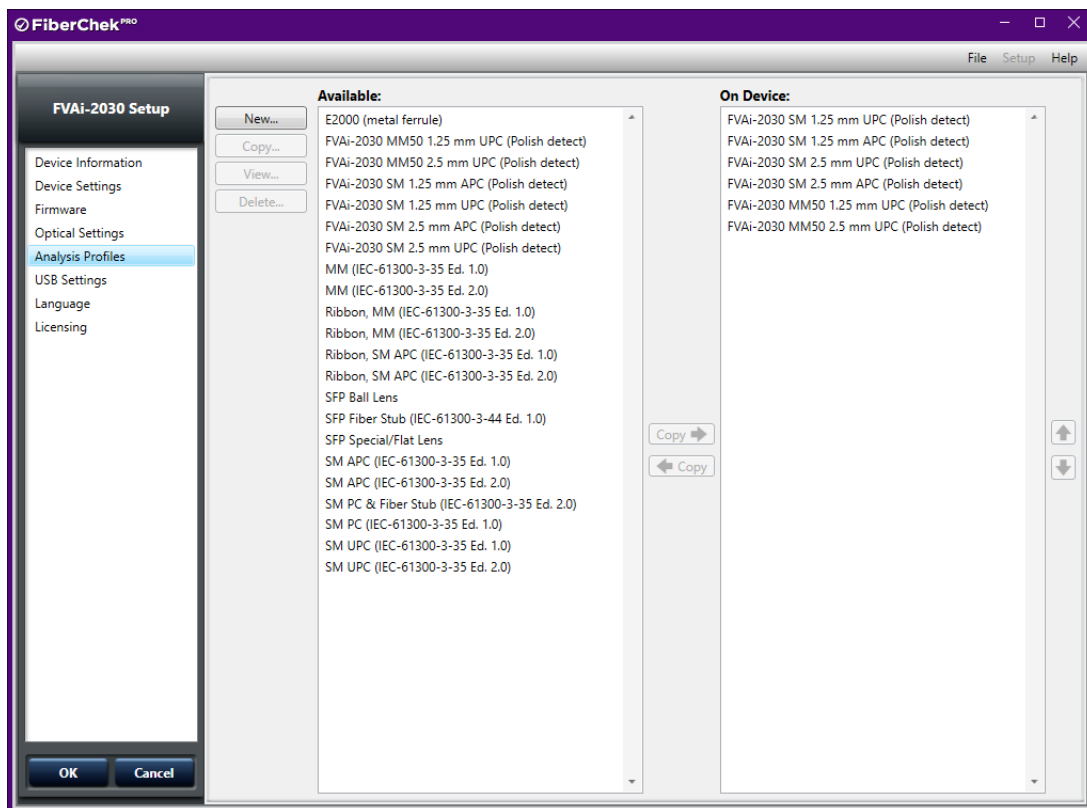

Step 4 Do one of the following:

- To create a new FVAi-2030 profile, select **New** to access the **Edit Profile** dialog.

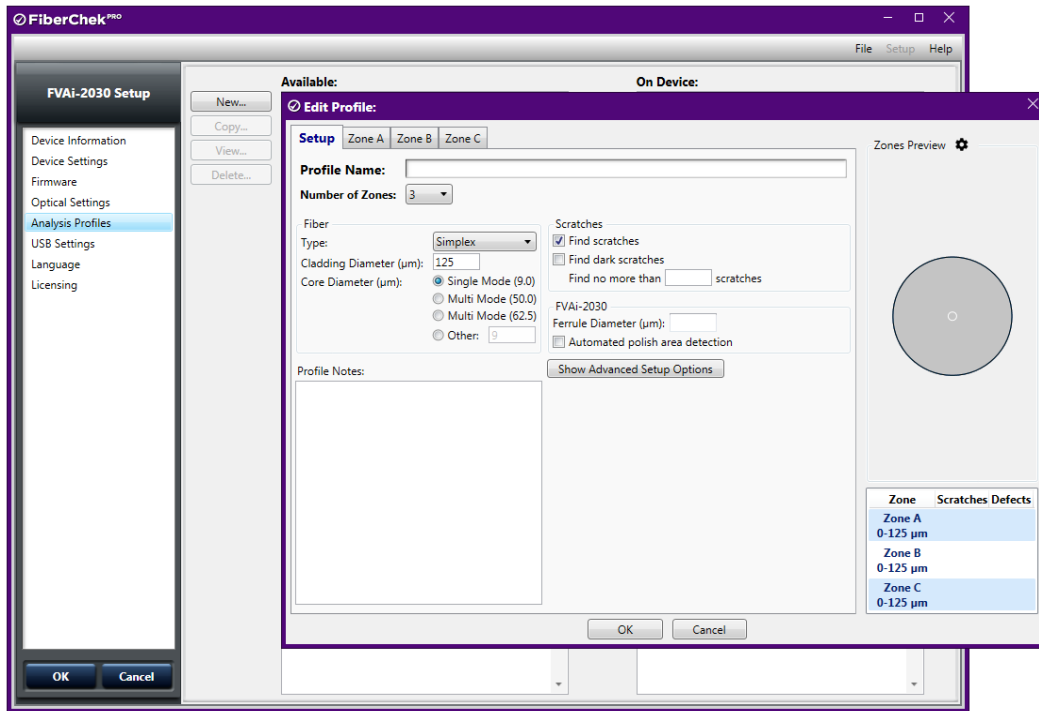

- To create a customized copy of an existing FVAi-2030 profile, select an FVAi-2030 profile in either list, and then select **Copy** to access the **Edit Profile: Copy of** dialog.

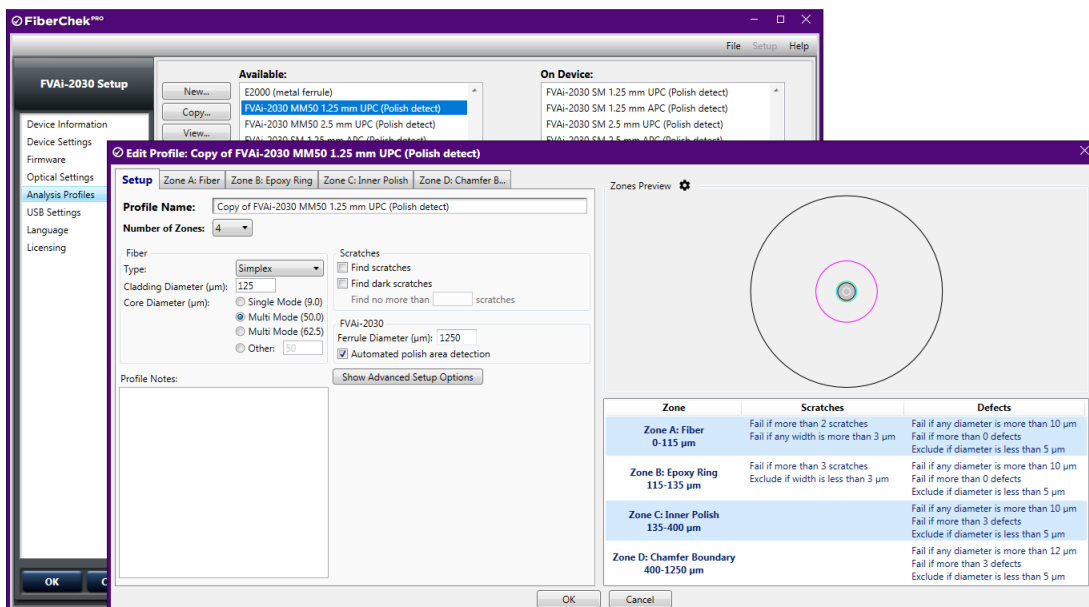

**Note:** Ensure that you select an FVAi-2030 profile to copy. Profiles intended for use with other devices should not be modified for use with the microscope.

Step 5 On the **Setup** page, specify or modify general settings for the profile.

Parameter	Description
Profile Name	<p>Unique name of the profile.</p> <p><b>Note:</b> FVAi-2030 analysis profiles define settings exclusive to the microscope (see the parameter <a href="#">FVAi-2030</a> in this table). VIAVI recommends including <a href="#">FVAi-2030</a> in the name of the profile to help identify it as an FVAi-2030-specific profile.</p>
Number of Zones	<p>Number of zones of interest. Refer to the <b>Zone Preview</b> view in the dialog.</p> <p><b>Note:</b> Zones appear as series of concentric circles on the view of the fiber end face, starting with the smallest zone centered on the core (see <a href="#">“Performing Pass/Fail tests and generating reports” on page 4-3</a>). Failure criteria is defined for each zone.</p>
Fiber Type	Type of fiber being tested.
Cladding Diameter (µm)	Fiber cladding diameter (Default = 125 µm).
Core Diameter (µm)	<p>Fiber core diameter.</p> <p><b>Note:</b> FiberChekPRO identifies the core with an overlay of the core diameter in addition to the specified zones (see <a href="#">“Performing Pass/Fail tests and generating reports” on page 4-3</a>).</p>
Scratches	<p>Detection parameters for scratches:</p> <ul style="list-style-type: none"> <li>• <b>Find Scratches:</b> Enable to detect any scratch.</li> <li>• <b>Find dark scratches:</b> Enable to detect scratches that are dark. <ul style="list-style-type: none"> <li><b>Note:</b> Enabling this feature will significantly impact the amount of time required to complete a Pass/Fail test.</li> </ul> </li> <li>• <b>Find no more than:</b> Set a limit for the number of scratches to be detected. <ul style="list-style-type: none"> <li><b>Note:</b> VIAVI recommends setting a high value (e.g., 25) to speed up analysis of severely scratched fiber end faces.</li> </ul> </li> </ul>
FVAi-2030	<p>Settings for use with the FVAi-2030 microscope:</p> <ul style="list-style-type: none"> <li>• <b>Ferrule Diameter (µm):</b> Ferrule diameter of fiber being tested. (Required setting.)</li> <li>• <b>Automated polish area detection:</b> Enable to automate detection of polish area.</li> </ul>
Profile Notes	Information about the profile.
Show/Hide Advanced Setup Options	<p>Access or hide setup options:</p> <ul style="list-style-type: none"> <li>• <b>Sensitivity:</b> Parameterize for greater or lesser sensitivity (on a scale of 0 to 10), affecting what defects will be found (i.e., cladding dirt, cladding pits/chips, ferrule dirt, and/or scratches. <p>Low settings enable detection of easily visible scratches and defects, and define them as existing only in the zones where these are clearly present. High settings enable detection of extremely faint scratches and defects that are otherwise difficult to detect reliably.</p> <ul style="list-style-type: none"> <li><b>Note:</b> High settings are intended for use only in post-polish applications for process control purposes, and are not recommended for connectors that are already in the field.</li> </ul> </li> <li>• <b>Overall Inspection Criteria:</b> Define specific criteria relating to epoxy gap and core saturation.</li> <li>• <b>Add Password Protection:</b> Enable password protection on the profile.</li> </ul>



Step 6 For each available zone, select the tab for the zone and specify settings as required:

- **Name, Inner Diameter, Outer Diameter, and Outer Diameter Color** for the zone.
- **Scratches:** Specific acceptance criteria for scratches.
- **Defects:** Specific acceptance criteria for defects, including any non-scratch defect on the connector (dirt, debris, pits, chips). Specific criteria can be defined for both **Individual** and **Combined** defects.

Select **Enable Advanced Criteria** to define additional options to fine-tune acceptance criteria that address specific requirements.

- **Exclusion Zone:** Inner and outer radius in which defects and scratches are not counted toward the acceptance criteria.

Step 7 Select **OK** to close the dialog for the profile.

A new FVAi-2030 profile is automatically added to the **On Device** list. An FVAi-2030 profile created using a copy of an existing profile is automatically added to the same list from which the original profile was selected (Step 4).

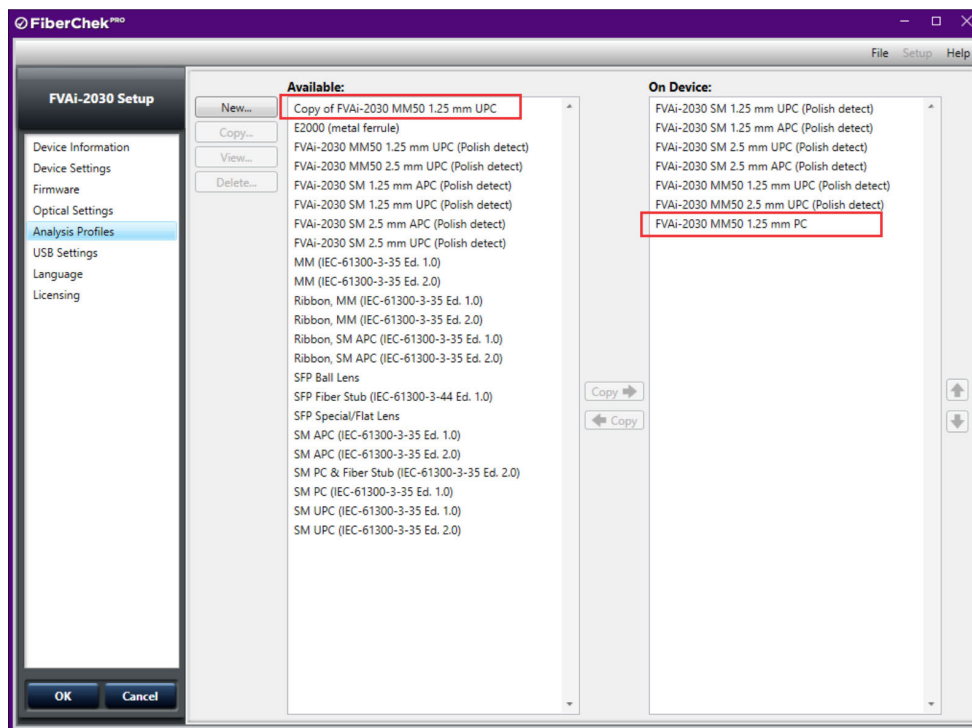

Step 8 Select **OK** in the navigation pane to return to the Inspection window.

— End —

# Appendix A Firmware update

FiberChekPRO facilitates firmware management by identifying available firmware update versions for each device it supports, including the FVAi-2030 microscope.

**Note:** Firmware for the FVAi-2030 microscope is specific to the FVAi-2030 model and is not supported by other FV Series microscope models.

## Performing a firmware update

Step 1 Connect the microscope to FiberChekPRO (see [“Connecting to FiberChekPRO” on page 4-2](#)).

If the microscope is running an earlier firmware version and FiberChekPRO is set up to automatically check for updates at startup, the **New Firmware** dialog appears in the **FiberChekPRO** application window, prompting you to download the updated firmware to your computer.

Step 2. Do the following:

- i. In the **New Firmware** dialog, click **Download Now**.

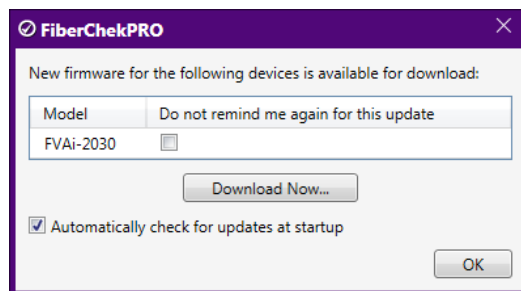

ii. In the **FiberChekPRO Setup** dialog, click **Download** for the microscope model.

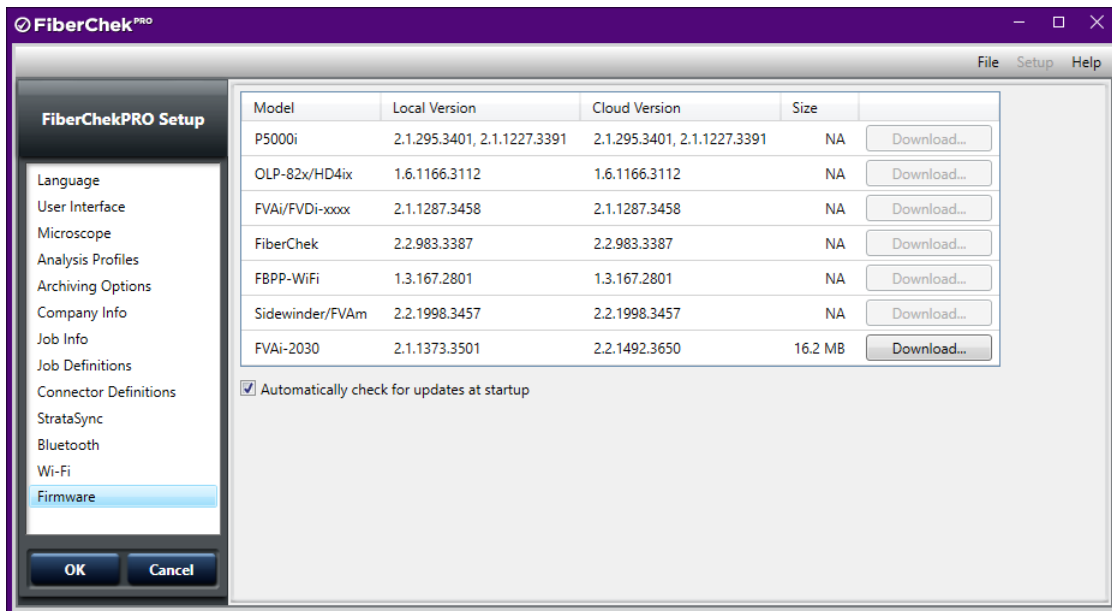

iii. When the download is completed, click **OK** in the **FiberChekPRO Setup** navigation pane to return to the FiberChekPRO application window.

Step 3. On the **Setup** menu, select the microscope.

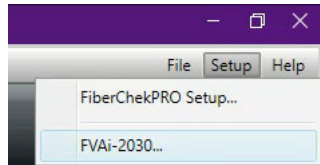

Step 4. On the **Setup** page for the microscope, select the **Firmware** option in the navigation pane, and then click **Update Firmware**.

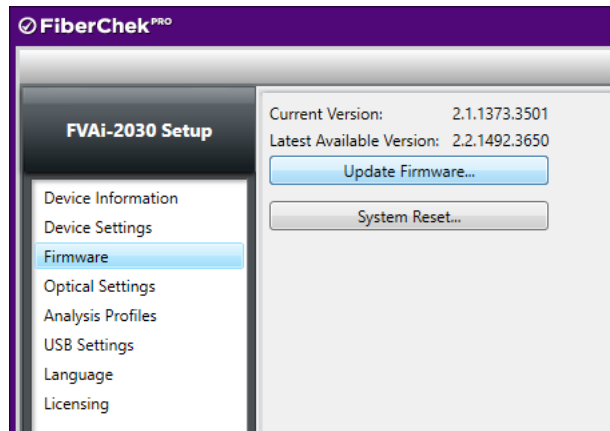

Step 5. Click **Update** to start the update.

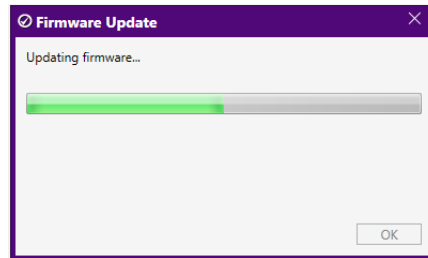

Step 6. When the update is successfully completed, click **OK** to reboot the microscope.

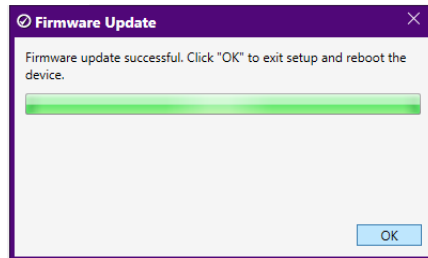

After the microscope reboots, it automatically reconnects to FiberChekPRO.

Step 7. Access the **Firmware** option on the **Setup** page for the microscope (see [Step 3](#) and [Step 4](#)), and note the firmware version.

Step 8. Select OK in the navigation pane to return to the Inspection window.

— End —

## Appendix B System reset

When required, you can perform a system reset to return the firmware running on an FVAi-2030 microscope to an earlier version. From that version, you can update to the firmware version you require. This facilitates maintaining firmware-version stability and uniformity across a fleet of deployed microscopes.

**Note:** If you must return to an earlier version of the firmware, you must first perform a system reset. You can then update to a firmware version later than the version defined by the system-reset threshold.

### Important:

- VIAVI strongly recommends that you refer to the document [Standardizing Device Firmware](#) for information about the system reset process, including limitations, before you perform this procedure.
- A system reset deletes all test results, custom analysis profiles and optical settings available on the microscope, and restores all factory-set options. Therefore, before you start a system reset, ensure that all required custom profiles and optical settings are available on FiberChekPRO. For information, see *FiberChekPRO Automated Fiber Inspection and Analysis Software User Manual*.

### Performing a system reset

Step 1 Connect the microscope to FiberChekPRO (see [“Connecting to FiberChekPRO” on page 4-2](#)).

Step 2 On the **Setup** menu, select the microscope.

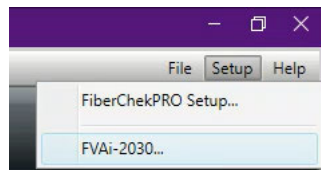

Step 3 On the **Setup** page for the microscope, select **Firmware** in the navigation pane, and then click **System Reset**.

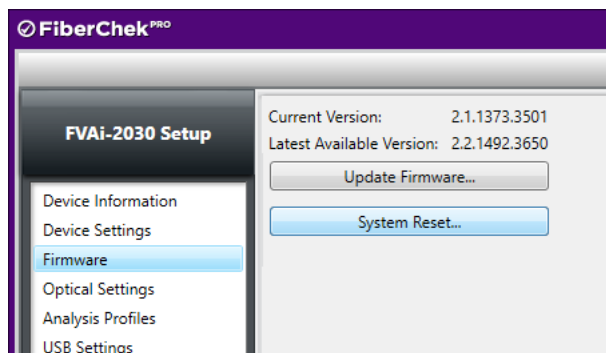

**Note:** The **System Reset** button is available only while the firmware version installed on the microscope is either the same version defined by the system-reset threshold or a later version.

Step 4 Click **Next** to either download the system reset package or proceed to the next dialog.

**Note:** The system reset package is downloaded only during a first-time system reset.

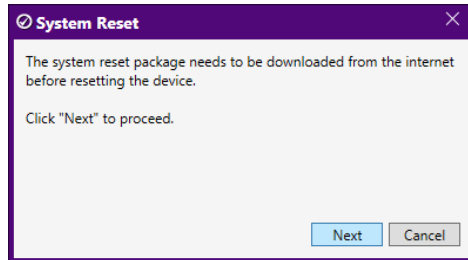

A dialog containing warning information appears.

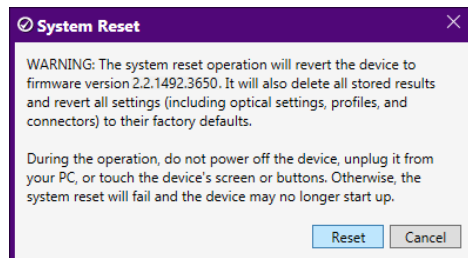

Step 5 Review the information, and then click **Reset** to start the system reset.

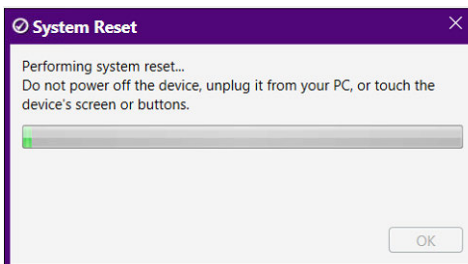

The system reset can take several minutes to complete.

Step 6 When the system reset is successfully completed, click **OK** to reboot the microscope.

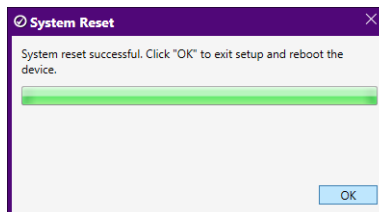

After the microscope reboots, it automatically reconnects to FiberChekPRO.

— End —

# Appendix C Specifications

**Table C-1: FVAi-2030 Benchtop Microscope specifications**

Parameter	Specification
Auto-focus enabled	Yes
Particle Size Detection	< 10 $\mu\text{m}$
Camera Sensor	2560 x 1920, 1/2.5-in CMOS, 5 megapixels
Built-in LCD Screen Size, Resolution	High-contrast 3.5-in color LCD with touchscreen functionality Live Image (pixels): 320 x 240 x 8 bit gray, 10 fps
Light Source, Technique	Blue LED (100,000+ hours life) Coaxial
Adapter Type	FMAX SL Series
USB Ports	Host (x1): USB Type B Device (x2): USB Type A
External Display Port, Resolution	VGA, 640 x 480
Dimensions (H x W x D)	214 x 135 x 211 mm (8.4 x 5.3 x 8.3 in) See <a href="#">Figure C-1</a> .
Weight	3.1 kg (6.8 lb)
Power Supply	12V, 2A with interchangeable wall plug for EU, UK, US, and AU
Certification	CE, EN/IEC 61326

**Figure C-1: FVAi-2030 Benchtop Microscope dimensions (mm)**

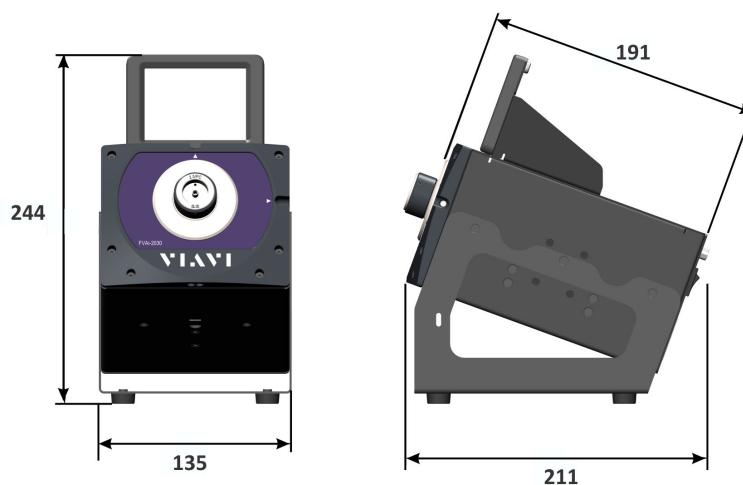



## Appendix D Document revision history

Table 1: FVAi-2030 Benchtop Microscope User Guide, 22112369-339

Revision	Date	Details
R002	November 2023	<ul style="list-style-type: none"><li>• Added the section “Safety instructions”</li><li>• Updated the section “Accessing Live view”</li></ul>
R001	November 2022	<ul style="list-style-type: none"><li>• Updated frontmatter content.</li><li>• Updated VIAVI address on back cover.</li></ul>
R000	December 2021	This document is released.





## **Multiple Application Platform FVAi-2030 Benchtop Microscope User Guide**

22112369-339 R002, Standard

November 2023

English

### **VIAMI Solutions Inc.**

1445 South Spectrum Blvd., Suite 102

Chandler, AZ, 85286

USA

North America: (Toll Free) 1-844-GO-VIAMI / 1-844-468-4284

All Other Regions: [www.viavisolutions.com/contacts](http://www.viavisolutions.com/contacts)