

Manual for **Basic**

FOMA® N900iS '04.6



DoCoMo W-CDMA System

- Thank you for choosing the FOMA N900iS.
This Manual for FOMA N900iS 『Basic』 contains the following 7 sections: “Getting Started”, “Basic Operations”, “Advanced Operations”, “Using Network Services”, “Entering Characters”, “Appendix” and “Troubleshooting”.
- Please read this Manual for FOMA N900iS 『Basic』 and the separate manual 『Application』 carefully before and during using the FOMA N900iS for the effective operation.

Before using your FOMA terminal

- FOMA terminals operate using radio waves, so phone calls cannot be made in locations where radio waves cannot be received. You cannot use the FOMA terminal in tunnels, underground areas, inside buildings, and outdoor locations where reception is poor, or out of the service areas. You may also experience difficulties making phone calls from the upper floors of tall buildings, even if there is no obvious physical obstruction. When reception is good (i.e. the reception level indicator shows 3 bars) and you do not move during the call, you may still find that your call is cut off.
- When you use your FOMA terminal in public places, particularly where it is crowded or quiet, be mindful of not disturbing the people around you.
- Because the FOMA terminal uses radio waves to communicate, there is always the risk of your calls being intercepted by a third party. However, the W-CDMA system automatically supports tapping prevention for all calls. In this way, even if a third party succeeds in intercepting your call, only incomprehensible noise will be heard.
- The FOMA terminal communicates via radio waves by converting voices into digital signals. If you move into an area where signal reception is poor, the digital signals may not be accurately decoded and what you hear may differ slightly from what was actually said.
- It is the user's responsibility to keep a separate record of all data (names, phone numbers, e-mail addresses, etc.) stored on your FOMA terminal. NTT DoCoMo shall not be held liable for any loss of stored data.
- The user hereby agrees that the user shall be solely responsible for the results of using SSL. Neither NTT DoCoMo nor the certifier as listed herein makes any representation or warranty as to security in the use of SSL. In the event that the user shall sustain any damage or loss due to the use of SSL, under no circumstances shall either NTT DoCoMo or the certifier be held responsible for any such damage or loss.
Certifier: VeriSign Japan K.K., Baltimore Technologies Japan Co., Ltd.
- The FOMA terminal can be used only via the FOMA network provided by DoCoMo.

Read this manual carefully before using your FOMA N900iS and FOMA card. Before using the battery pack and the various adapters (including the charger), carefully read their respective manuals also. Should you have further questions regarding the manuals, contact NTT DoCoMo at any of the following numbers:

○ **Inquiries (NTT DoCoMo Group):**

From an ordinary (landline) phone:



0120-005-250 (toll free) (in English)

※ You can call this number from any type of phone, including DoCoMo mobile phones and PHS phones.
※ Check the phone number carefully before dialing.

From a DoCoMo mobile phone or PHS phone:

151 (no area code) (toll free) (in Japanese only)

※ You cannot call this number from an ordinary (landline) phone.

Note that the **FOMA N900iS** is referred to simply as “FOMA terminal” in this manual for **FOMA N900iS 『Basic』**.

- The Internet function used in this product is NetFront® v3.0 for FOMA.
NetFront v3.0 is a product from ACCESS CO., LTD.
- NetFront and **NetFront** are registered trademarks or trademarks of ACCESS CO., LTD. in Japan and other countries.
Copyright© 1996-2004 ACCESS CO., LTD.
- Software used for this product contains a module developed by Independent JPEG Group.

Copyrights and portrait rights

The copyright laws prohibit unauthorized use of photographs or movies and site (program) or Web page information obtained by using the FOMA terminal without the permission of the relevant copyright holders except for personal use.

Any unauthorized reproduction or editing, and the use of reproduced or edited products, without the copyright of reproduced products or the permission for reproduction or edition by copyright holders, is an infringement of the copyright law and related laws. Such abuse may lead to the payment of damages to the copyright holders and other concerned parties, so please refrain from such usage.







Besides the above action, changing, modifying and processing other people's portraits without permission is in breach of portrait rights. Please refrain from reproducing, editing and processing photographs and movies taken or recorded with the FOMA terminal.

Note that filming or recording plays, entertainment, and exhibitions may be prohibited even if for personal use.

Please also be aware of copyrights and portrait rights when releasing filmed or recorded data on Web pages, etc.

Trademarks and registered trademarks

All brand names and product names are registered trademarks or trademarks of their respective companies.

- "FOMA", "mova", "i-mode", "i-αppli", "i-αppli DX", "WORLD CALL", "Driving mode", "QUICKCAST", "Multi access", "i-motion", "i-motion mail", "movie ringtone", "Deco-mail", "Chara-den", "i-anime", "Dual network", "M-stage V live", "FirstPass" and "FOMA" "i-mode" logos are trademarks or registered trademarks of NTT DoCoMo.
- Licensed by QUALCOMM Incorporated under one or more of the following United States Patents and/or their counterparts in other nations:
4,901,307 5,490,165 5,056,109 5,504,773 5,101,501
5,506,865 5,109,390 5,511,073 5,228,054 5,535,239
5,267,261 5,544,196 5,267,262 5,568,483 5,337,338
5,600,754 5,414,796 5,657,420 5,416,797 5,659,569
5,710,784 5,778,338
- miniSD™ is the trademark of SD Association. 
- Java and all Java-related trademarks and logos are trademarks or registered trademarks of US Sun Microsystems, Inc. in the US and other countries.
- LC Font, LC FONT® and the LC logo are registered trademarks of Sharp Corporation. 
- T9 Text Input® and T9 logo are registered trademarks of Tegic Communications. 
- T9 Text Input® is patented or under patent application worldwide.
- Dialog Clarity, WOW, SRS and the  symbol are trademarks of SRS Labs, Inc. The Dialog Clarity technology and WOW technology are industrialized based on the license from SRS Labs, Inc.  
- Catch Phone (Call waiting service) is a registered trademark of Nippon Telegraph and Telephone Corporation.
- QR Code is the registered trademark of Denso Wave, Inc.
- Macromedia® Flash™ technology from Macromedia, Inc. is used in this product. Copyright © 1995-2004 Macromedia, Inc. All right reserved.
Macromedia, Flash, and Macromedia Flash are trademarks or registered trademarks of Macromedia, Inc. in the US and other countries.
- "Super CCD honeycomb" is a registered trademark of Fuji Photo Film Co., Ltd.
- "Dimo" is the trademark or registered trademark of Buena Vista Internet Group.
- © 2004 DEVILROBOTS

How to Use The Instruction Manual

This 『Basic』 manual covers the following:

“Getting Started” :

Describes how to prepare your FOMA terminal to use and things you should know before first use.

- Component names and functions
- Menu operations
- How to install/remove the FOMA card, and how to charge the battery pack

“Basic Operations” :

Describes the basic operations of your FOMA terminal.

- Making/receiving a voice call/videophone call, and how to store an entry in the phonebook

“Advanced Operations” :

Describes the functions to use your FOMA terminal more conveniently.

“Using Network Services” :

Describes useful network services such as Voice mail service.

“Entering Characters” :

Describes how to enter characters with your FOMA terminal.

“Appendix” :

Lists the glossary and menu functions.

“Troubleshooting” :

Lists malfunction checklist and error messages.

- **Before using your FOMA terminal, please be sure to read the “Safety Precautions” and “Handling and Care” in this manual to use the N900iS correctly.**
- **This manual describes the basic operation procedure for the FOMA terminal. If you are using the FOMA terminal for the first time, please be sure to read this manual first before reading 『Application』.**

In addition to this manual 『Basic』, the following manual is supplied with your FOMA terminal:

『Application』

- Describes how to use the i-mode, mail, and camera functions, and how to set up data communications using a PC.

“Quick Manual” provides the end of 『Application』 (p.492).

Please keep these manuals in a safe place for future reference.

Contents

Copyrights/Trademarks	1
How to Use The Instruction Manual	2
How to Use This Manual	3
Contents	4
Special Features of the FOMA N900iS	10
Mastering the FOMA N900iS !	12
Safety Precautions (ALWAYS FOLLOW THESE DIRECTIONS)	14
Handling and Care	26
Checking the Package	29

Getting Started

External Features of the FOMA N900iS

Component Names and Functions	32
How to View the Display	37
How to View the Indicator Display (Rear Panel Display)	40

About the Menus

Menu Functions	42
Menu Operations	44

Before Using

Setting the FOMA Card	51
FOMA Card Operational Restriction Function	53
FOMA Card Versions	54
Charging the Battery Pack	55
Power On/Off	62
Checking the Battery Level	63
Switching the Screen Display to English	65
Setting the Date and Time	65
Notifying Your Phone Number to the Other Party	66
Checking Your Own Phone Number	67
Blocking Nuisance Calls	68

Basic Operations

Making/Receiving Phone Calls

Making a Call	70
Dialing a Previously Dialed Number	72
Making International Calls	73
Receiving a Call	75
Checking Missed Calls and New Mail	76
Adjusting the Earpiece Volume	78
Adjusting the Ring Volume	79
Hands-free Compliant Devices Ready for Use	80

Settings for When You Cannot Take Calls

Putting Calls on Hold When You Cannot Answer Immediately	81
When You are Driving and Cannot Take Calls	82
Having the Caller Leave a Message	84

Making/Receiving Videophone Calls

About a Videophone Call	87
Making a Videophone Call	88
Receiving a Videophone Call	92
Enjoying a Chara-den	94
Settings for Making a Videophone Call	95
Setting the Image to be Sent to the Other Party	96
Setting the Image to be Displayed During a Videophone Call	100
Setting the Remote Monitor	102

Using the Phonebook

Phonebook Available with the FOMA Terminal	106
Storing an Entry in the Phonebook	108
Searching the Phonebook	116
Editing the Phonebook	119
Distinguishing Incoming Calls for Each Phone Number and Group	120
Setting Up Phonebook Functions	124
Deleting an Entry in the Phonebook	128
Changing a Group Name	128
Saving the Phonebook in the FOMA Card	130

Checking the Storage Status of the Phonebook	134
--	-----

Setting Manner Mode

Turning Off Sounds Emitted by the FOMA Terminal	135
Changing the Manner Mode Setting	136

Advanced Operations

Using Phone Functions

Setting the Time Until the Ringing Operation Starts	140
Restricting Incoming/Outgoing Calls to/from Each Specified Number	141
Rejecting Calls from the Phone Number not Stored in the Phonebook	144
Rejecting Calls with No Caller ID	145
Sending Push Signals for Easy Operation	146
Attaching a Number Before the Phone Number	149
Setting for Subaddress Support	150
Using Dialed or Received Calls Records	151
Making Your Phone Conversation Clearer	156
Setting Notification of a Dropped Line	157
Setting Alarm Notification of a Bad Connection	158
Selecting the Guidance for Holding Calls	158
Setting to Stop the Ring Tone Quickly	159
Setting Operations When the FOMA Terminal is Folded During a Call	160
Displaying the Call Duration During a Call	161
Checking/Resetting the Total Call Duration	161

Changing Tone Settings

Selecting a Ring Tone for Incoming Calls and Mail	163
Using Vibration to Notify You Incoming Calls and Mail	167
Turning Off the Keypad Sound	168
Setting the FOMA Terminal to Emit the Charge Sound	169

Changing the Display and Keypad Settings

Using the Desktop Icons	170
Displaying Your Favorite Image on the Screen	177
Setting the Display of Images Stored in the Phonebook	181
Setting the Image Viewer Display	181
Changing the Display Color	182

Setting Whether to Turn On/Off the Display Light for the Display and Keys	183
Setting the Incoming Call Lamp to Flash at Incoming Call	185
Setting the Incoming Call Lamp to Flash During a Call	186
Setting the Way the Indicator Display is Displayed	187
Switching the Fonts	190
Setting the Clock Display	191

Restricting Phone Operations

Utilizing PIN Number	192
Changing Your Security Code	193
Setting PIN Codes	194
Entering the PIN1 Code When the Power is Turned On	197
Canceling PIN Lock	198
About Lock Function	199
Preventing Other People from Using Your FOMA Terminal	200
Preventing Other People from Seeing Your Phonebook and Schedule	201
Restricting Private Information Operations	204
Prohibiting a Call by Dialing	205
Setting Dialed or Received Call Record not to be Displayed	206
Prohibiting Incoming/Outgoing Communication	207
Disabling the Side Keys While the FOMA Terminal is Folded	208

Using Alarm Notification Functions

Using Alarm Notification	209
Using the Alarm Clock Function	213
Using the Schedule Function	216
Listing Things to Do	228

Using Useful Tools

Using the Calculator Function	234
Creating a Text Memo	234
Using Dictionaries	237

Using Other Functions

Storing/Editing Your Own Data	239
Changing the Menu Display	243
Recording Your Voice or the Other Party's Voice	246
Playing/Deleting Record Messages and Voice Memos	247

Recording/Playing an Alarm or Hold Tone	249
Setting the Neuropointer	251
Resetting the Settings	254
Setting the Communication Service Company	259
Using an Earphone	259

Multi Access/Multi Task

Multi Access	263
Multi Task	267

Using Network Services

Using Network Services

Network Services Available for the FOMA Terminal	272
Voice Mail Service	273
Call Forwarding Service	278
Call Waiting Service	281
Bar Nuisance Call Service	284
Notify Caller ID Service	285
Caller ID Request Service	286
Dual Network Service	287
English Guidance	289
Service Dial	290
Setting the Way to Handling Incoming Calls During a Call	291
Controlling Network Services Remotely	294
Storing a New Service	295

Entering Characters

Entering Characters

About Character Entry	300
Entering Characters in 5-touch	303
Copying/Cutting/Pasting Characters	319
Storing Frequently Used Words	321
Setting the Dictionary to Use	323
Creating and Changing Common Phrases	324
Setting a Character Input Method	326

Entering Characters in T9 (Mode 3)	332
Entering Characters in 2-touch (Mode 2)	336
Switching the Screen to Operate	338

Appendix

Appendix

Glossary	340
Overview of the Keypad Charecter Assignments (5-touch Input)	341
Overview of the Keypad Charecter Assignments (T9 Input)	342
Overview of the Keypad Charecter Assignments (2-touch Input)	343
Symbols and Special Characters List	344
Lists of Pictographs and Smiley Face Symbols	345
Lists of Common Phrases	346
Kuten Code List	347
Multi Access Combination Patterns	351
Multi Task Combination Patterns	352
Services Available for the FOMA Terminal	353
Options and Accessories	354
Menu Function List	355
Major Specifications	362

Troubleshooting

Troubleshooting

Malfunction Checklist	364
Resetting to the Default Setting	369
List of Error Messages	370
Warranty and After-Sales Service	373
About Software Update	375
Index	381

The Quick Manual is provides the end of "Application" manual (p.492).

Special Features of the FOMA N900iS

FOMA (Freedom of Mobile multimedia Access) is the name of DoCoMo's service based on the W-CDMA system approved as one of the global standards for third-generation mobile telecommunication systems (IMT-2000).

Supports packet transmission at speeds of up to 384 kbps, and high-speed data transmission

- Connecting an external device such as a PC to the FOMA terminal enables speedy packet transmission providing a maximum speed of 384 kbps for downloading. The FOMA terminal supports 64K data communication.
- An external device such as a PC is necessary for data communication.

Compatible with i-mode service and more user-friendly mail service

- You can comfortably use the site (program) connection services, internet connection, i-αppli and i-motion with the high-speed packet communication capability of up to 384 kbps for receiving. Also, SMS (free) used without a specific application for the service and i-mode mail (charged) used as mail through the Internet are available.
- A separate subscription (charged) is required for the i-mode service.

More compatible with multi access and multi task functions

- By Multi access that enables the FOMA terminal to handle a voice call and packet transmission at the same time, you can talk while enjoying the i-mode service or exchange mails during a call. The FOMA terminal also supports the multi task function that allows multiple applications simultaneously.
- A separate subscription (charged) is required for the i-mode service.
- In addition to multi access, you can use the SMS at the same time.

Supports the FOMA card

- The FOMA card is an IC card that holds your private information such as telephone number. You can use multiple FOMA terminals according to applications by switching your FOMA card.

Videophone

You can talk on the videophone to the other party with videophone-capable terminals face to face. If you switch to the handsfree mode, you can hear the other party's voice from the speaker. By operating Chara-den instead of displaying your own image, you can enjoy making Chara-den do various actions during a call.

It supports the remote monitor with the camera function to check the behavior of your pet in your home from outside, or observe the local conditions such as a plant or operation status from a remote location. Your FOMA terminal can work as a terminal for both sending and receiving remote monitor data.

p.87

Camera

You can take pictures (still images), continuous multiple pictures and movies using the two cameras, in-camera and out-camera. The out-camera has a Super CCD honeycomb of 2 million recordable pixels (1 million valid pixels) and is capable of taking a large picture of 1616 × 1212 dots.

It also loads the "Chance capture" function, which records movies retroactively from the point you end shooting, and the "Picture voice" function, which adds voice to pictures (still images) taken. Movies shot with these functions are saved in the Movie player as movies and can be sent with i-mode mail.

Application
p.254

Speed photo mail

You can send a picture (still image) taken during a voice call to the other party you are talking with easily. This function allows you to send not only a picture (still image) taken during a voice call but also a saved picture (still image) in the FOMA terminal.

Application
p.169

Deco-mail (Decoration mail)

You can change the color of the character of the body and compose and send mail decorated with subtitle flashing, etc. (Deco-mail). You can also receive Deco-mail to enjoy expressive mail.

Application
p.173

miniSD memory card

You can transfer data such as phonebooks, schedule, mail and images between the FOMA terminal and the miniSD memory card. You can also display and/or delete data stored in the miniSD memory card and connect it to a PC to use the miniSD reader/writer function. In addition, the long time movie mode of the camera function allows you to store shot movies directly into the miniSD memory card and shoot movies for up to one hour.

Application
p.365

Template

You can compose greeting cards such as daily mail and birthday card using the templates stored in your terminal. You can send/receive fun mail using greeting cards.

Application
p.180

T9 (Mode)

The more advanced T9 (Mode) word conversion enable you to input characters with less key operations

p.332

Dictionary

You can use three types of easy-to-use dictionaries; English-Japanese, Japanese-English and Japanese. You can search words at the same time you compose mail.

p.237

Read out

The message of received mail can be read out in male, female or robot voice according to the settings. For mail received from the address with an image stored in the phonebook, the stored image is displayed during the read out.

Application
p.232

Rich network services

Dual network service (charged)

- A separate subscription is required.

p.287

Voice mail service (charged)

- A separate subscription is required.

p.273

Call forwarding service (free)

- A separate subscription is required.

p.278

Short message service (SMS) (free)

- No subscription is required.

Application
p.198

i-mode functions

i-mode (charged)

This is an online service used by i-mode-compatible mobile phones. The i-mode services include site (program) connection, which gives users access to services provided on those sites by IPs (information providers); Internet connection, which provides users with access to Web pages; and i-mode mail, which allows users to exchange e-mail messages with Internet users.

- A separate subscription is required.

Application
p.24

i-mode mail

You can call up the mail menu by just pressing  while the standby display is displayed. You can save up to 1,000 received messages and 400 sent messages on your FOMA terminal.

Application
p.136

i-motion

You can download audio and video data into your FOMA terminal from i-motion supported sites to play and save it for later replay. The saved i-motion can be used as a ring tone.

Application
p.95

i-motion mail

You can send movies recorded with the built-in camera and i-motion downloaded from sites or Web pages as an i-mode mail attachment.

Application
p.164

i-appli

You can use the FOMA terminal conveniently by downloading i-appli software from sites.

For example, you can enjoy various games on your FOMA terminal by downloading game programs.

Application
p.66

Mastering the FOMA N900iS !

Visual communication with the FOMA N900iS

“Video-phone” enables you to talk to the other party face-to-face

Videophone lets you see the other party in real time while talking. p.87

You can talk to the other party face-to-face while listening to his/her voice through the speaker.

Switching the in-camera and out-camera enables the other party to see the scenery.



Instead of your self-portrait, you can display a substitutive animated image and move its mouth and limbs.

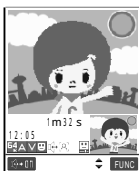

“Greeting card” allows you to send greeting cards in easy operation “Greeting cards”

Sending greeting cards using a wide array of templates. p.180 in ^FApplication

You can create various types of fun mail messages ranging from daily messages to birthday cards.

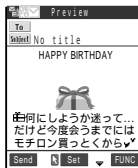

“Speed photo mail” sends a picture (still image) during a voice call

During a voice call, you can take a picture such as a scenic shot and send it immediately.

p.169 in ^FApplication



“Picture voice” sends a picture (still image) with your voice

You can send a picture (still image) with your voice message.
p.266 in ^F Application _a

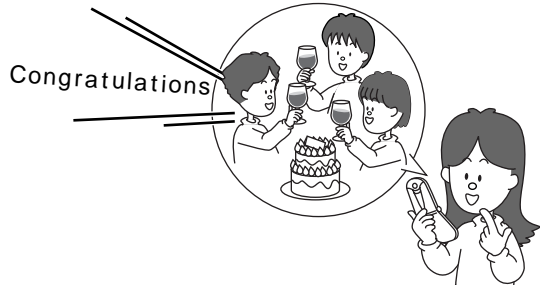

“Camera” can be used just like a digital camera or digital video recorder.

Taking a picture (still image) or shooting movie. p.254 in ^F Application _a

Take a picture (still image) in “Photo mode”, “Mega pixel mode” and save it. You can attach it to mail, set it to the standby display or incoming call display, and edit it with a frame or character stamps.

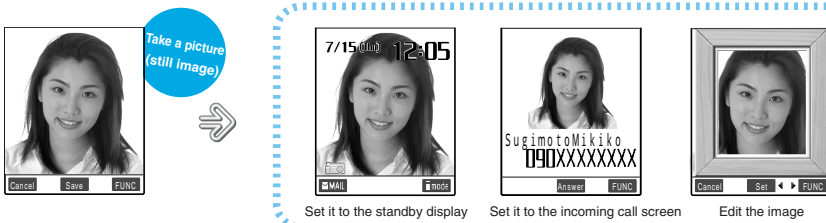

Take continuous multiple pictures in “Continuous mode” and save them. You can view them like animation, select your favorite ones among these pictures and save them.



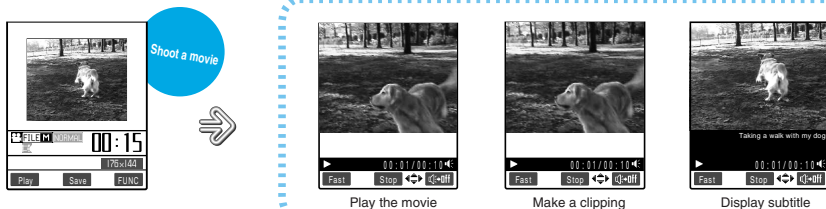

Shoot a movie in “Movie mode”, “Chance capture” or “Long duration mode” and save it. With “Chance capture” mode, you can shoot it without missing the important scenes. With “Long duration mode”, you can shoot it until the storage limit of miniSD memory card is reached. The shot movie can be attached to mail, clipped as a still image, or edit a subtitle.









- To ensure that you use your FOMA terminal correctly, read this “Safety Precautions” carefully prior to use. Keep this manual in a safe place for future reference.
- These safety precautions must be observed at all times since they contain information intended to prevent bodily injury and damage to property.
- The following symbols indicate the different degrees of injury and damage that may occur if the information provided is not observed and the FOMA terminal is used incorrectly.

 DANGER
This symbol indicates that death or serious bodily injury may directly and immediately result from improper use.

 WARNING
This symbol indicates that death or serious bodily injury may result from improper use.

 CAUTION
This symbol indicates that serious bodily injury and/or property damage may result from improper use.

- The following symbols indicate specific directions:

 Don't	Indicates a prohibited action.
 No disassembly	Indicates not to disassemble the device.
 No wet hands	Indicates not to handle the device with wet hands.
 No liquids	Indicates not to use the device near water, and not to get it wet.
 Do	Indicates a compulsory action for the described direction.
 Unplug	Indicates that the power cord should be unplugged from the power outlet.

- “Safety Precautions” are explained in the following categories:

1. Handling the FOMA Terminal, Battery Pack and Adapter (including a Charger) (Common)	15
2. Handling the FOMA Terminal	17
3. Handling the Battery Pack	20
4. Handling the Adapters (including a Charger)	22
5. Handling the FOMA Card	24
6. Handling Mobile Phones near Electronic Medical Equipment	25

1. Handling the FOMA Terminal, Battery Pack and Adapter (including a Charger) (Common)

DANGER



Do

Use only the battery packs and adapters (including a Charger) specified by NTT DoCoMo for use with the FOMA terminal.

The use of devices other than those specified by DoCoMo may result in the battery pack and other parts leaking, overheating, exploding or catching fire.

Battery Pack N06 Desktop Holder N04 AC Adapter N03 DC Adapter N03
Data Communication Adapter N01

For information on other compatible products, contact a DoCoMo service counter.

WARNING



Don't

Do not place the FOMA terminal, battery pack, charger or adapters inside cooking appliances such as microwave ovens or in a pressure cooker.

The battery pack may leak, overheat, explode or catch fire, and the FOMA terminal, charger and adapters may overheat, emit smoke, catch fire or suffer damage to internal circuitry.



Don't

Do not use the FOMA terminal in locations where there is a risk of explosion or fire, such as gas stations.

Use of the FOMA terminal in dusty environments or in locations where there are flammable gases such as propane or gasoline may cause an explosion or fire.



Don't

Do not drop, throw or subject the FOMA terminal, battery pack, charger or adapters to strong force or impacts.

The battery pack may leak, overheat, explode or catch fire. Other electronic components may also be damaged or catch fire.

 **CAUTION**



Do

If the FOMA terminal is used by children, the children's parent or guardian should teach them how to use the FOMA terminal and make sure that they always use the FOMA terminal correctly, as instructed.

Improper usage could result in bodily injury.



Don't

Do not leave the FOMA terminal on a sloping or unstable surface.

The FOMA terminal may fall and cause an injury or be damaged.



Do

Keep the FOMA terminal out of the reach of young children.

A small child may swallow one of the components or suffer other bodily injury.



Don't

Do not keep the FOMA terminal in locations that are very humid or dusty or subject to high temperatures.

Doing so may damage the FOMA terminal and cause it to malfunction.



Don't

Do not use or leave the FOMA terminal, battery pack, charger or adapters in locations subject to high temperatures, such as in direct sunlight or inside a car on a hot day.

The battery pack may leak, overheat, explode or catch fire, and the FOMA terminal may become deformed or malfunction.

Part of the casing may also become hot and cause burns.

2. Handling the FOMA Terminal

WARNING



Don't

Never use the FOMA terminal while driving a vehicle.

Doing so may interfere with safe driving and cause an accident. Stop your vehicle in a safe place before using the FOMA terminal. In addition, prohibited acts, such as using the phone while driving, may be punishable by law.



No disassembly

Do not attempt to disassemble or modify the FOMA terminal

Doing so may cause a fire, bodily injury, electric shock or equipment malfunction.



Do

Turn off the FOMA terminal in areas where the use of mobile phones is prohibited, such as in aircraft or hospitals.

The FOMA terminal may interfere with the operation of sensitive devices and electronic medical equipment. Before turning the FOMA terminal off, ensure that the Auto power ON function, if available, is set to "OFF". Follow the instructions given by the respective medical facility regarding the use of mobile phones on their premises. In addition, prohibited acts, such as using the phone in an aircraft, may be punishable by law.



Do

If you have a weak heart, you should take extra precautions when setting functions such as the Vibrator and Ring volume functions for incoming calls.

Your heart may be adversely affected.



Don't

Do not use or leave the FOMA terminal in locations subject to high temperatures, such as near a fireplace or heating appliance.

The FOMA terminal may overheat, catch fire or cause a malfunction.



Don't

Do not aim or direct the infrared data port towards another person's eyes when using infrared communication.

Doing so may cause eye injury. Also, do not aim or direct the infrared data port towards another infrared device as this may cause the device to malfunction.



Do

Turn the FOMA terminal off near high-precision electronic equipment or devices that use weak electronic signals.

The FOMA terminal may interfere with the operation of sensitive electronic equipment.

※ Take particular care with the following devices:

Hearing aids, implantable cardiac pacemakers, implantable cardioverter-defibrillators, and other electronic medical equipment fire alarms, automatic doors and other equipment controlled by electronic signals. If you use an implantable cardiac pacemaker, implantable cardioverter-defibrillator or other electronic medical equipment, contact the respective manufacturer or vendor to check whether the operation of the equipment is affected by radio waves.



Don't

If you are wearing electronic medical equipment on your body, do not put the FOMA terminal in your breast pocket or in the inside pocket of your jacket.

The FOMA terminal is a folding mobile phone and uses magnets to detect that it is closed. Using the FOMA terminal in close proximity to electronic medical equipment may cause the equipment to malfunction.



Do

Hold the FOMA terminal off your ear and keep enough distance with it when you talk in the handsfree mode with the speaker.

It may affect your hearing or cause interference to your ears.



Don't

Do not shine the light at anyone driving a car or other vehicle.

This will interfere with safe driving and could cause an accident.



Don't

Keep the miniSD memory card out of reach of children.

Children may accidentally swallow it.

- If this occurs, contact a doctor immediately.

2. Handling the FOMA Terminal (continued)

CAUTION



Do

In some types of vehicle, use of the FOMA terminal in the vehicle may interfere with the operation of the vehicle's electronic equipment.

Do not use the FOMA if the terminal might impair safe driving.



Don't

Never swing the FOMA terminal by its strap or other parts.

The FOMA terminal may strike you or others around you, resulting in bodily injury or damage to the FOMA terminal or other property.



No liquids

Keep the FOMA terminal dry.

Exposing the FOMA terminal to liquids such as water or pet urine may cause overheating, malfunction, electric shock or injury. Be careful where and how you use the FOMA terminal.



Don't

Do not put fluids such as water or objects such as pieces of metal or flammable materials into the miniSD memory card slot.

Such actions could cause fire, electric shock or fault.



Do

Take care when loading or removing the miniSD memory card.

Injury to hands or fingers could occur.



Don't

Do not pour liquid like water or insert a metal piece or any inflammable pieces into the FOMA card insertion slot of the FOMA terminal.

Such actions could cause fire, electric shock or fault.



Don't

Do not let the FOMA terminal come close to or sandwich magnetic cards and other magnetic recording media between the FOMA terminal.

The stored magnetic data in cash cards, credit cards, telephone cards and floppy disks, etc. may be erased.



Do

If you hear thunder while using the FOMA terminal outdoors, immediately turn off the FOMA terminal and take shelter in a safe location.

There is a risk of being struck by lightning and suffering an electric shock.

CAUTION



Do

If in the event that the display or camera lens breaks, be careful of the broken glass.

The surface of the display and camera lens is covered by a plastic panel so as to minimize the possibility of glass scattering. However touching a broken display or camera lens may result in injury.



Don't

Do not leave the built-in camera lens exposed to direct sunlight for a long period of time.

The light-collecting nature of the lens may cause fire or failure.



Don't

Do not switch the light on when the FOMA terminal is close to your eyes. Take care also not to bring the light close to your eyes or look directly into the light while it is lit.

This could cause impaired vision or otherwise adversely affect your eyes. Accidents such as injury may also happen due to sudden movement from an unexpected occurrence.



Don't

Do not use the light for other use than shooting with the built-in cameras.

The light will be off after approximately 30 seconds of no operation. Using it for purposes outside of shooting with built-in cameras (such as using it as an electronic torch) will cause the light run out suddenly which may lead to an accident.



Do

Use of the FOMA terminal may cause skin irritations such as itch, rashes or eczema in some people. If this occurs, immediately stop using the FOMA terminal and seek medical treatment.

Metal is used in the following locations.

※Location used: Material

Lens selection switch, Multi-function keys, Function key 1 & 2 and Neuropointer key

: Chrome-plated, undercoat;

Nickel-plated and copper-plated

Part of front case (display area)

: Magnesium alloy MD1D (JIS) or equivalent

3. Handling the Battery Pack

■ Refer to the information shown on the battery pack label to check the type of battery pack you have.

Label description	Battery type
Li-ion	Lithium-ion

DANGER



Don't

Do not use or leave the battery pack in locations subject to high temperatures, such as near a fireplace or heating appliance.

The battery pack may leak, overheat, explode or catch fire.



Don't

Do not throw the battery pack into a fire.

The battery pack may leak, overheat, explode or catch fire.



Don't

Do not connect metallic objects such as wires across the battery pack terminals, and do not carry or store the battery pack with metallic necklaces, etc.

The battery pack may leak, overheat, explode or catch fire.



Don't

If you are having difficulty in fitting the battery pack to the FOMA terminal, do not use excessive pressure to force the battery into place. Check that the battery pack is facing in the correct direction before you try to attach it.

The battery pack may leak, overheat, explode or catch fire.



Do

If battery fluid comes into contact with your eyes, do not rub your eyes but immediately rinse your eyes with clean water. Then seek prompt medical treatment.

Battery fluid is harmful to your eyes and may result in loss of eyesight.



Don't

Do not puncture the battery pack, hit it with a hammer or step on it.

The battery pack may leak, overheat, explode or catch fire.



No disassembly

Do not attempt to disassemble or modify the battery pack and do not solder it directly to the FOMA terminal.

Doing so may cause the battery pack to leak, overheat, explode or catch fire.



No liquids

Keep the battery pack dry.

Exposing the battery pack to liquids such as water or pet urine may cause overheating, electric shock or malfunction. Be careful where and how you use the battery pack.

WARNING



Do

If the battery pack is not fully charged after the specified charging time has elapsed, stop charging.

Overcharging may cause the battery pack to leak, overheat, explode or catch fire.



Do

If the battery pack leaks or emits an unusual odor, stop using it immediately and move it as far as possible away from any flame or fire.

The battery fluid is flammable and could ignite, causing a fire or explosion.



Don't

If you notice anything unusual about the battery pack, such as an unusual odor, overheating, discoloration or deformation, during use, charging or storage, immediately remove it from the FOMA terminal and do not use it again.

Continued use of a faulty battery pack may cause the battery pack to leak, overheat, explode or catch fire.



Don't

Do not use or leave the battery pack in locations subject to high temperatures, such as in direct sunlight or inside a car on a hot day.

The battery pack may leak, overheat or suffer performance loss and a reduced service life.



Do

If battery fluid comes into contact with your skin or clothing, stop using the FOMA terminal immediately and rinse it off with clean water.

Battery fluid is harmful to your skin.

CAUTION



Don't

Do not dispose of used battery packs in ordinary garbage.

Throwing battery packs out with ordinary garbage constitutes an environmental hazard and may cause the garbage to catch fire. Apply insulation tape to the terminals of used battery packs and return them to a DoCoMo service counter. Alternatively, if there are separate battery disposal facilities in your area, dispose the battery packs in accordance with your local regulations.

4. Handling the Adapters (including a Charger)

WARNING



Do

Always use the specified power supply and voltage.

Using the incorrect voltage may cause a fire or malfunction. Use in overseas countries may cause malfunction, etc.
AC adapter: 100V AC (Plug it to 100V AC power outlet for home use in Japan only.)
DC adapter: 12V DC and 24V DC (specific to vehicle with negative ground)



Don't

The DC adapter is only for use in vehicles with a negative ground. Never use the adapter in positively grounded vehicles.

Use in a positively grounded vehicle may cause a fire.



No liquids

Keep the adapters and the charger dry.

Exposing the adapters and the charger to liquids such as water or pet urine may cause overheating, electric shock or malfunction. Be careful where and how you use the adapters and the charger.



Do

If the fuse in the DC adapter blows, always replace it with a fuse of the specified type.

The use of incorrect fuse may cause a fire or malfunction.
Refer to the respective manuals for information on the correct fuse specifications.



No disassembly

Do not attempt to disassemble or modify the adapters or charger.

Doing so may cause a fire, electric shock or equipment malfunction.



Don't

Never use a damaged adapter's or charger's power cord or DC power cord.

Doing so may cause an electric shock, overheating or fire.



No wet hand

Do not touch the power cords of the adapters and charger or the power outlet with wet hands.

Failure to observe this precaution may result in an electric shock.



Don't

Take care not to short-circuit the charging terminal when the adapter or charger is connected to a power outlet or the cigarette lighter socket in a vehicle. Take care also not to allow any part of your body (fingers, etc.) to come into contact with the charging terminal.

Failure to observe this precaution may result in a fire, electric shock, bodily injury, or equipment malfunction.



Don't

Never use the AC adapter or the desktop holder in humid or steamy locations such as a bathroom.

Doing so may result in an electric shock.



Do

Wipe off any dust on the charger plug or adapter plug.

Dust may cause a fire.



Unplug

Always unplug the adapter or charger from the power outlet when it will be left unused for a long period.

Failure to observe this precaution may result in a fire, electric shock or equipment malfunction.



Unplug

If any water or other liquid gets into the adapter or charger, immediately unplug it from the power outlet or cigarette lighter socket.

Water in the adapter or charger may cause an electric shock, smoke emission or fire.



Don't

Place the charger or desktop holder on a stable surface during charging. Take care also not to cover or wrap the charger or desktop holder with clothing or bedding.

Doing so may cause the FOMA terminal to fall out of the charger or heat to build up, resulting in a fire or malfunction.



Do

When plugging the AC adapter into a power outlet, make sure that no metallic straps or other metallic objects are caught between the plug and the socket.

Failure to observe this precaution may result in an electric shock, short-circuit or fire.

 **CAUTION**



Unplug

Always pull the plug out of the power outlet or cigarette lighter socket before cleaning the adapter or charger.

Failure to observe this precaution may result in an electric shock.



Don't

Do not place heavy objects on the AC or DC power cord for the adapter or charger.

Doing so may cause an electric shock or fire.



Don't

Do not charge the wet battery pack.

The battery pack may overheat, explode or catch fire.



Do

Always grasp the plug when unplugging the adapter or charger from the power outlet or cigarette lighter socket. Do not pull on the cord itself.

Pulling on the cord may damage the cord and cause an electric shock or fire.

5. Handling the FOMA Card

WARNING



Don't

Do not place the FOMA card in cookware for heating, e.g. a microwave oven, etc. or a high pressure vessel such as a pressure cooker.

Failure to observe this precaution may result in melting, overheating, emission of smoke, loss of data or malfunction.

CAUTION



Do

Be careful when dismantling the FOMA card (IC part).

Your hands or fingers may be hurt.



Do

Use the FOMA card with equipment specified by DoCoMo.

If you use a FOMA card with another equipment than specified, it may lead to the loss of data or equipment malfunction. For specified combinations of a FOMA card and equipment, contact a nearby DoCoMo service counter.



No disassembly

Do not disassemble or modify the FOMA card.

Failure to observe this precaution may result in loss of data or malfunction.



Don't

Do not use or leave the FOMA card in locations subject to high temperatures, such as near a fireplace or heating appliance.

Failure to observe this precaution may result in melting, overheating, emission of smoke, loss of data or malfunction.



Don't

Do not incinerate or heat the FOMA card.

Failure to observe this precaution may result in melting, overheating, emission of smoke, loss of data or malfunction.



Don't

Do not tamper or short-circuit the IC part carelessly.

Failure to observe this precaution may result in loss of data or malfunction.



Don't

Do not drop the FOMA card or apply a shock on it.

Doing so may cause malfunction.



Don't

Do not bend the FOMA card or apply weight on it.

Doing so may cause malfunction.



No liquids

Keep the FOMA card dry.

Exposing the FOMA card to liquids such as water or pet urine may cause malfunction.



Don't

Do not scratch the IC part.

Doing so may cause malfunction.



Don't

Do not keep the FOMA card in a dusty place.

Doing so may cause malfunction.



Don't

Do not keep the FOMA card in locations subject to direct sunlight, high humidity, or high temperatures.

Doing so may cause malfunction.



Do

Keep the FOMA card out of the reach of young children.

A small child may swallow the FOMA card or suffer bodily injury.

6. Handling Mobile Phones near Electronic Medical Equipment

■ The following safety precautions conform to the guidelines drawn up during the Electromagnetic Compatibility Conference, Japan, regarding the protection of electronic medical equipment from radio waves emitted by mobile phones.

WARNING



Do

If you use an implantable cardiac pacemaker or implantable cardioverter-defibrillator, keep the FOMA terminal at a distance of at least 22 cm.

Radio waves may affect the operation of implantable cardiac pacemakers or implantable cardioverter-defibrillators if used in close proximity.



Do

Turn off the FOMA terminal in crowded places such as rush-hour trains in case somebody nearby is using an implantable cardiac pacemaker or implantable cardioverter-defibrillator.

Radio waves may affect the operation of implantable cardiac pacemakers or implantable cardioverter-defibrillators if used in close proximity.



Do

Observe the following in hospitals or other medical facilities:

- Do not take your FOMA terminal into operating rooms, ICUs (Intensive Care Units) or CCUs (Coronary Care Units).
- Turn off your FOMA terminal inside hospital wards.
- Turn off your FOMA terminal even when you are in an area outside hospital wards, such as a hospital lobby, since electronic medical equipment may be in use nearby.
- Where a medical facility has specific instructions prohibiting the carrying and use of mobile phones, observe those instructions strictly.
- If your FOMA terminal has the Auto power ON function, disable this function before turning your FOMA terminal off.



Do

Patients receiving medical treatment away from a hospital or medical facility (e.g. home treatment) who are using electronic medical equipment other than implantable cardiac pacemakers or implantable cardioverter-defibrillators should consult the respective manufacturers for information regarding the effects of radio waves on the equipment.

Radio waves may affect the operation of implantable cardiac pacemakers or implantable cardioverter-defibrillators if used in close proximity.

General Notes

Do not expose to water.

- The FOMA terminal, battery pack, adapters and charger are not waterproof. Do not use them in humid or steamy locations such as bathrooms, and avoid exposing them to rain and other forms of moisture. If you carry your FOMA terminal close to your skin, sweat may cause internal components to corrode and result in a malfunction. Note that if the problem is found to be due to moisture, it will not be covered by the warranty and in some cases may be irreparable. Even where repairs are possible, repair charges will be incurred since the damage is not covered by the warranty.

Clean only with a soft, dry cloth.

- Rubbing the LCD of the FOMA terminal with a dry cloth to clean it may scratch the LCD surface. Handle the FOMA terminal carefully and clean it using a soft dry cloth (of the type used for eyeglasses). Note also that the LCD coating may peel off or stain if moisture or soiling is left on the surface for a long period.
- Never use chemicals such as alcohol, thinners, benzene or detergents as these agents may erase the printing on the FOMA terminal or cause discoloration.

Occasionally clean the connection terminals with a dry cotton bud.

- Soiled connection terminals may result in poor connections and loss of power. Also, as it may cause insufficient charging performance, clean the terminal with a dry cloth or cotton bud.

Do not place the FOMA terminal near an air conditioning vent.

- Condensation may form due to rapid changes in temperature, and this may cause internal corrosion and malfunction.

Do not leave the FOMA terminal in locations where it may be subject to excessive pressure or weight.

- Do not put the FOMA terminal in a bag filled with other objects or in the hip pocket of clothing as you sit down. Such actions may result in faults or damage to the LCD or other internal components. Such damage is not covered by your warranty.

Read the separate manuals supplied with the battery pack, adapters and charger carefully.

Handling the FOMA Terminal

Avoid using the FOMA terminal in extremely high or low temperatures.

- Use the FOMA terminal at temperatures between 5°C and 35°C with humidity between 45% and 85%.

It is normal for the FOMA terminal to become warm while being used or charged. Therefore you can continue to use it.

Using the FOMA terminal close to ordinary (landline) phones, TVs or radios may affect the operation of such equipment. Move as far as possible away from such items before using the FOMA terminal.

It is the user's responsibility to keep a separate record of all data (names, phone numbers, e-mail addresses, etc.) stored in your FOMA terminal.

- Under no circumstances shall NTT DoCoMo be held liable for any loss or damage to the data stored in your FOMA terminal.

Take care not to put the FOMA terminal in the back pocket of your pants or skirt and then sit on it. Also, do not put the FOMA terminal at the bottom of bag where it may be subject to excessive pressure or weight.

- Doing so may damage the FOMA terminal and cause malfunction.

Do not close the FOMA terminal while its strap is caught between the folding parts.

- Doing so may damage the FOMA terminal and cause malfunction.

Always fit the earphone/microphone socket cap, external connector cap and miniSD memory card slot cover before use.

- Failure to fit these covers could result in problems caused by dust or water getting into the FOMA terminal.

The Battery Pack

Battery packs have a limited service life.

- If a battery pack does not work despite fully charging, it has reached the period of replacing the battery pack. Replace it with a new battery pack with the same specifications.

Charge the battery pack in a location within the correct temperature range (5°C to 35°C).

Make sure that the battery is charged when you use the FOMA terminal for the first time or have not used it for a long period of time.

The available operating time of the battery pack differs depending on the conditions in which you are using it and the condition of the battery pack itself.

Do not dispose of used battery packs in the ordinary garbage.

- Apply insulation tape to the terminals of used battery packs, and return them to a DoCoMo service counter. Alternatively, if there are separate battery disposal facilities in your area, dispose the battery packs in accordance with your local regulations.

Handling the Adapters and Charger

Do not charge the battery pack in the following situations:

- Where the ambient temperature is lower than 5°C or higher than 35°C.
- In very humid or dusty locations or in locations exposed to strong vibrations.
- Close to appliances such as ordinary (landline) phones, TVs or radios.

During charging, the adapter, charger may become warm. This is normal, so let the charging continue.

Do not use the DC adapter to charge battery packs when the car engine is not running.

- Doing so may drain the car battery.

If you use an electrical outlet with a disconnection prevention mechanism, follow the instructions of the outlet's user manual.

Handling the FOMA Card

When removing the IC part, never apply force more than necessary.

When inserting the FOMA card into the FOMA terminal, never apply unnecessary force.

During using, the FOMA card may become warm. This is normal, so you can continue using it.

The warranty does not cover damage caused by inserting the FOMA card into some other type of IC card reader or writer. It is the user's responsibility.

Always keep the IC part clean.

Clean the FOMA card with a soft, dry cloth.

It is the user's responsibility to keep a separate record of all data (names, phone numbers, e-mail addresses, etc.) stored on your FOMA card.

- Under no circumstances shall NTT DoCoMo be held liable for any loss or damage to the data stored in your FOMA card.

To preserve the environment, bring used FOMA cards to a DoCoMo service counter.

Avoid using the FOMA card in extremely high or low temperatures.

Handling the miniSD Memory Card

Do not remove the miniSD memory card or switch the FOMA terminal off during miniSD memory card operation.

- Doing so may result in loss of data or FOMA terminal malfunction.

Handling the Camera

If you seriously inconvenience others when using the FOMA terminal, you may be liable to prosecution under respective laws or bylaws (such as Public Nuisance Laws).



Please be considerate of the privacy of individuals around you when taking and sending pictures using camera-equipped mobile phones.

Restrictions on i-motion clip

MPEG-4 technology used for movie and i-motion clip in this product is allowed to use for the following purposes. However, it is prohibited to use for other purposes by patent right regarding this technology.

- Use to play encoded data or information for personal and noncommercial use without any intention to be rewarded.
- Use to play data or information obtained without any charge from other customers who do not work for commercial enterprise.
- Use to play data or information only for personal use.
- Any other usages including individually-permitted ones by the U.S. companies, MPEG LA and L.L.C. which take charge of patent right regarding this technology.

Checking the Package

- Make sure that you have all the items listed below. If any items are missing, contact the retailer where you purchased your FOMA terminal.

FOMA N900iS

(including warranty card, rear cover N02)



Battery Pack N06

(including manual)

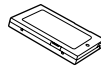

AC Adapter N03

(including warranty card and manual)

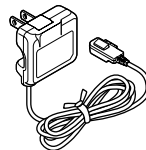

Desktop Holder N04

(including manual)

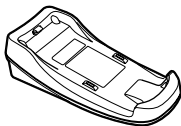

miniSD memory card (16MB)/miniSD memory card adapter

(including soft case and manual)



(sample)



(sample)

Manual for FOMA N900iS Basic (this manual)

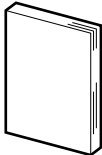

Manual for FOMA N900iS Application

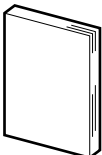

* The Quick Manual provides the end of "Application" manual (p.492).

CD-ROM for FOMA N900iS

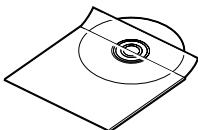



Getting Started

External Features of the FOMA N900iS	32
About the Menus	42
Before Using.	51

Component Names and Functions

In this manual, keys are represented as below icons.

Earpiece speaker

- Allows you to hear the other party's voice.

In-camera

- Used to shoot pictures (still images) and movies or send your video to the other party during a videophone call. →p.87, and p.255 in 『Application』

Display

- How to view the display. →p.37

Home/



+Volume/() key

- Connects to the set site easily. →p.61 in 『Application』
- Lights the display light for the indicator display when pressed with the FOMA terminal folded.
- Increases the earpiece volume during a call. →p.78
- Moves the cursor to the previous character assigned to the same key during character entry. →p.302
- Turns the light on when using a camera. →p.262 in 『Application』
- Scrolls back the display to the previous screens by page.

Memo/Check/

-Volume/() key

- Sets the "Manner mode" during an incoming call and activates the "Record message". →p.136
- Plays recorded messages. →p.247
- Checks for missed calls and new mails with the FOMA terminal folded. →p.77
- Lowers the earpiece volume during a call. →p.78
- Takes pictures (still images) with the FOMA terminal folded. →p.263 in 『Application』
- Scrolls the display to the next screens by page.

(The  and  keys together are called "Side keys" in this manual.)

External connector

- Used to connect optional external devices to the FOMA terminal. →p.58, and p.391 in 『Application』

Light

- Turned on when using a camera. →p.262 in 『Application』

Incoming call/Charge lamp

- This flashes when a voice or videophone call comes in or when mail or Msg. Request/Free is received. You can change the lamp flashing color and synchronize the flashing with a melody such as the ring tone (Illumination). →p.185
- The light turns red during charging.

Rear panel

Out-camera

- Used to shoot pictures (still images) and movies or send images such as scenery to the other party during a videophone call. →p.87, and p.254 in 『Application』

Speaker

- Sounds such as the ring tone and voice of the other party during the handsfree mode are emitted from here.

Indicator display

- Tells you FOMA terminal condition by displaying messages, icons and animations. →p.38 and p.40

miniSD memory card slot

- Insert the miniSD memory card. →p.371 in 『Application』

Rear panel

Rear cover

Charging terminals

Mouthpiece/Front mike

- Sends your voice.
- Do not cover the mouthpiece while you are talking. This may prevent the other party from hearing your voice.
- Used as the microphone when the camera is used in the Movie mode and "Picture voice".

Size (mm) ^{*1}	Width 48 × Height 102 × Depth 26
Mass (g) ^{*2}	Approx. 115g

*1 : Height and depth are for the FOMA when folded.

*2 : When the battery pack is attached.

Multi-function keys

Up key

- Moves the cursor or highlighted display upward (towards the reversed direction).
- Scrolls up the display. Hold the key down to continue scrolling.
- Displays the phonebook menu screen.
- Converts the entered characters into kanji, katakana and numbers. →p.305

Left key/Received call record key

- Moves the cursor to the left.
- Scrolls back the display to the previous screens by page.
- Displays the received call record. →p.151

Neuropointer key

- How to use the Neuropointer →p.35

Right/Redial key

- Moves the cursor to the right.
- Scrolls the display to the next screens by page.
- Displays the redial record. →p.72

Down key

- Moves the cursor or highlighted display downward.
- Scrolls down the display. Hold the key down to continue scrolling.
- Displays the "Search phonebook" menu screen. →p.116
- Converts the entered characters into kanji, katakana, number. →p.303

Function key 1

- Executes an operation displayed on the Soft key placed on the bottom left side of the display. →p.34

Multi-key

- Display the task menu. →p.265

Send key

- Makes a voice call. →p.70
- Answers a voice call. →p.75
- Answers a videophone call with the substitute image. →p.92
- Switches the entered characters into upper or lower case. →p.304

*** /Driving mode key**

- Enters "X", "http://" or other character strings. →p.341
- Enters the pause (p). →p.146

Videophone key

- Makes a videophone call. →p.88
- Answers a videophone call. →p.92
- Switches the substitute image/camera view while making a videophone call. →p.92

Function key 2

- Executes an operation displayed on the Soft key placed on the bottom right side of the display. →p.34

Menu key

- Displays the main menu. →p.44

**Power/Hold/
End of operation key**

- Hold down 1 second or more to turn the power on. →p.62
- Hold down 2 seconds or more to turn the power off. →p.62
- Ends a call. →p.70
- Puts a call on hold. →p.81

Back (clear) key

- Goes back to one step before.
- Puts a call on hold. →p.71
- Deletes the entered phone numbers or characters. →p.71 and p.317

#/Manner key

- Enters "#" or other symbols. →p.341
- Sets the "Manner mode" when a call is received and activates the "Record message". →p.136

Dial keys

- Enters phone numbers. →p.70
- Enters characters and numbers. →p.305

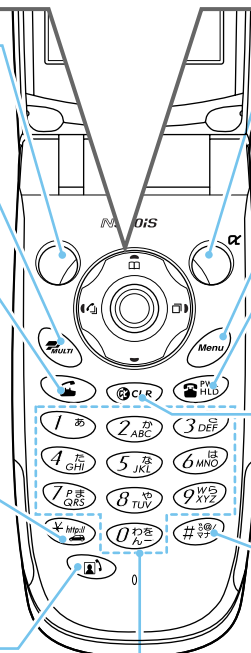

Lens selection switch

- Switches the lens on the out-camera to  (macrolens) to read data through the access reader or bar code reader. →p.283 in 『Application』

Infrared data port

- Window to send/receive infrared rays. →p.348 in 『Application』

Through-hole for strap

- ※:The antenna for the FOMA N900iS is built into the FOMA terminal.

miniSD memory card slot

- Slot for inserting the miniSD memory card. →p.371 in 『Application』

Earphone/Microphone terminal





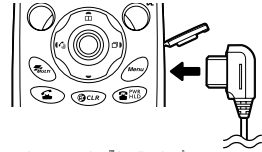





- When a flat-type earphone/microphone with switch (optional) is plugged in, handsfree operation is available. You can use a conventional earphone/microphone with switch by using the earphone jack conversion adapter. →p.259 and p.354

<How to connect earphone/microphone>



Functions that involve holding down keys for 1 second or more



The functions which are available by holding down each key for 1 second or more are as follows:

Key	Function	See Page	Key	Function	See Page
	Display light on/off	p.183		Side keys setting (while the main menu is displayed)	p.208
	Manner mode setting (while the standby display is displayed, during a call or an incoming call)	p.135		Earpiece volume adjustment (while the standby display is displayed or during a call)	p.78
	Driving mode setting (while the standby display is displayed)	p.82		Voice memo recording (only during a call)	p.247
	Multi task switch	p.268		Check new message (while the standby display is displayed)	→p.108 and p.184 in Application
	Standby display (during multi task)	p.268		i-αappli software list display (while the standby display is displayed)	→p.68 in Application

How to use the software keys

During standby or operation, guidance related to operation or settings displayed at the bottom of the display are referred to as software keys. To use the software keys, press the corresponding function keys.



■ To run the software key 1

Press  to run the software key displayed in 1. 1 includes [Mode], [Edit], [Store], [Finish], [Play], , etc.

■ To run the software key 2

Press  to run the software key displayed in 2. 2 includes [Select], [Set], [Play], [Change], etc.

■ To run the software key 3

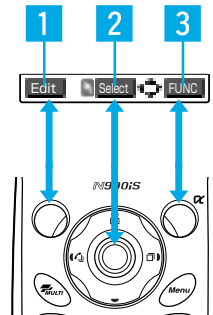

Press  to run the software key displayed in 3. 3 includes [FUNC], [Exit], etc. Press  while [FUNC] is displayed to display the function menu. →p.49



About the software key indication



The software keys are indicated as follows in this manual:

**How to use the Neuropointer**

When  is displayed at the bottom of the screen, slide the Neuropointer to display the pointer (). Moving the pointer by sliding the Neuropointer enables to quickly select an icon or item. When the list screen or function menu spreads across multiple pages, you can scroll a page up and down with the Neuropointer.

- The operating range of the pointer differs depending on a screen displayed.
- To select an item or icon, move the Neuropointer to the center and then press  [Select].
The Neuropointer cannot be pressed except at the center.
- You can change the pointer settings such as pointer display on/off, focus or speed in "Neuropointer". →p.251

Selecting an icon or item with the Neuropointer

- 1** Press  to display the main menu while the standby display is displayed, and then display  by sliding .





- 2** Slide  to  so that it is shown as , and then press  [Select].





The setting screen appears.



NOTE

- The pointer disappears in the following cases:
 - When you select another item by pressing  or other keys
 - When you display another screen
- The pointer disappears in the following cases. If you then slide Neuropointer, the pointer reappears at the position where it disappeared.
 - When you do not operate the Neuropointer for approx. 15 seconds
 - When you fold and reopen the FOMA terminal
- When you move the pointer to a place of no icon/item and press , the nearest icon/item to the pointer is selected, and then the pointer moves there automatically. However, the pointer does not move automatically in the following screens:
 - Screen memos
 - Site screens
 - Details screens for received mail/sent mail
 - Details screens for Msg. request/free
- The moving speed for the pointer differs depending on the operating display.
- You cannot use the neuropointer in some screens using flash images. In this case, "" is not displayed at the bottom of the screen.

1 Scrolling a screen up or down with the Neuropointer

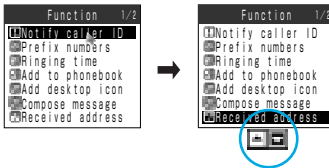
1 Slide  to display , and then move the pointer to the bottom of its operating range.



The pointer changes to .
When the pointer is moved to the top
The pointer changes to .

2 Press  [Select].

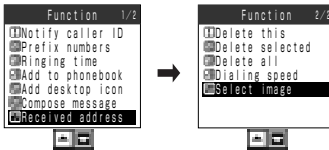

The next page of the function menu appears.

3 Slide  to the left to change  to , and then press  [Select].

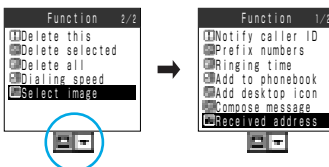









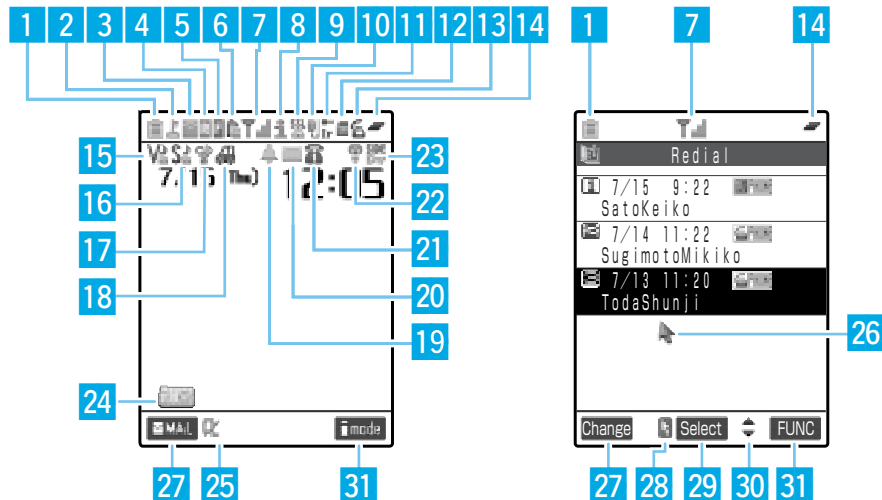











The previous page of the function menu appears.

How to View the Display

The marks (such as , , , etc.) displayed on the display and indicator display are referred to as icons. The icons include the following:

■ Display



- 1  Displays the battery level →p.63
- 2  Displayed while All lock is activated →p.200
- 3  Displayed in the Secret mode or Secret only mode →p.201
- 4  Displayed while PIM lock is activated →p.204
- 5  Displayed while Keypad dial lock is activated →p.205
- 6  Displayed while Keypad dial lock and Secret mode or Secret only mode are set at the same time →p.201 and p.205
- 7  Displayed while PIM lock and Keypad dial lock are set at the same time →p.204 and p.205
- 8  ~  ~  ~  ~  ~  ~  ~  ~  ~  ~  ~  ~  ~ ~

Indicator Display

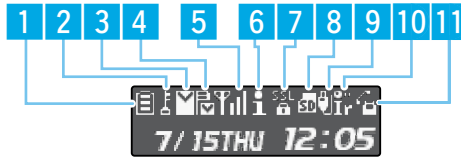

- | | |
|--|---|
| <p>1 Displays the battery level →p.63</p> <p>2 All lock →p.200
 Secret mode, Secret only mode →p.201
 PIM lock →p.204
 Keypad dial lock →p.205
 The Keypad dial lock and the Secret mode or Secret only mode are set at the same time →p.201 and p.205
 The Keypad dial lock and the PIM lock are set at the same time →p.204 and p.205</p> <p>3 →p.15 in 『Application』</p> <p>4 →p.15 in 『Application』</p> <p>5 Radio reception level →p.62
 Displayed when the FOMA is either out of the service area or when the radio wave is out of reach →p.62</p> | <p> Displayed in the Self mode →p.207</p> <p>6 →p.15 in 『Application』</p> <p>7 →p.15 in 『Application』
 Displayed when the Side keys guard is set to “ON” → p.208</p> <p>8 →p.15 in 『Application』</p> <p>9 →p.15 in 『Application』</p> <p>10 →p.15 in 『Application』</p> <p>11 During a voice call →p.70
 →p.15 in 『Application』
 Display the dialing speed of a videophone call →p.88
 Setting Manner mode →p.135</p> |
|--|---|

NOTE

- The display for this FOMA terminal adopts state-of-the-art technology; some dots (points) may not light up while others may constantly light up depending on its characteristics. Note that this phenomenon is not a failure.

Checking the meaning of the displayed icons

You can check the meaning of each icon displayed on the screen. It is useful for checking the functions set to your FOMA terminal via icons displayed on the screen.

1 Select   “Display” ▶ “Icons”.

2 Press  to position the cursor over the icon you want to check the meaning of.



The description of the selected icon appears at the bottom of the screen.

The meaning of the selected icon appears.

How to View the Indicator Display (Rear Panel Display)

The indicator display notifies you of incoming call/mail or alarm notification in various forms such as messages, images and animations so that you can immediately check the information without opening your FOMA terminal.

- The displayed information differs depending on the "Indicator display" settings (p.187).

About the display

■ Clock display

Displays the clock during standby. You can select from the following four types of display or "OFF (not displayed)":



Digital



Analog 1



Analog 2



Analog 3

■ During an incoming call display

Displays the phone number of an incoming call. When the caller's phone number is stored in your phonebook, information such as the caller's name appears. If no phone number is displayed, the reason for no number appears.



When the caller notifies the caller ID



When the caller's name is stored in your phonebook



When no phone number is displayed

■ During a call display

Displays the type of call during a call. Displayed when the FOMA terminal is opened.



During a voice call



During a videophone call



During remote monitor

■ During an outgoing call display

Displayed when the FOMA terminal is opened.



■ Alarm notification

For alarm notification of "Alarm clock", "Schedule" or "ToDo", an alarm notification animation corresponding to the function appears.



"Alarm clock"



"Schedule"/"ToDo"

■ Receiving a new mail

When "Mail" is set to "ON", after "Received message" is displayed, the sender and title are displayed.



■ During packet/64K data communication

Displays the type of communication during packet/64K data communication.



During packet communication



During 64K data communication

Checking the caller or sender

When the indicator display shows "Missed call" or "New message", you can check the caller/sender's name and the title of the mail. Press Δ [Home] with the FOMA terminal folded to display the contents of missed call record or new mails. If you press Δ [Home] again, you can check up to three missed calls or new mails. If you press Δ [Home] again after checking all items, the clock display reappears. If you have both missed calls and new mails, first the missed calls appear and then new mails appear.

- When you display the "Missed calls" record or delete the "Missed call" desktop icon, the missed call display in the indicator display disappears.
- When using the tool group function (p.42), you cannot check missed calls with the indicator display.

■ Missed call display



If you open the FOMA terminal, you can find the "Missed call" desktop icon on the display.



If you open the FOMA terminal, you can find the "Missed calls" record on the display.



After checking all items, the clock display reappears.

■ New mail display



If you open the FOMA terminal, you can find the "New mail" desktop icon on the display.



When the "Mail" is set to "ON", the sender, sent date and title are displayed.



After checking all items, the clock display reappears.

NOTE

- Press Δ [Home] with the FOMA terminal folded to turn the display light up. It is useful for checking the current time in the dark.
- In the power save mode, the indicator display shows nothing. Press Δ [Home] to display the view of the indicator display again.

Menu Functions

To set or check various functions with the FOMA terminal, you can call up each function from the main menu. The structure of the menus is as the following:

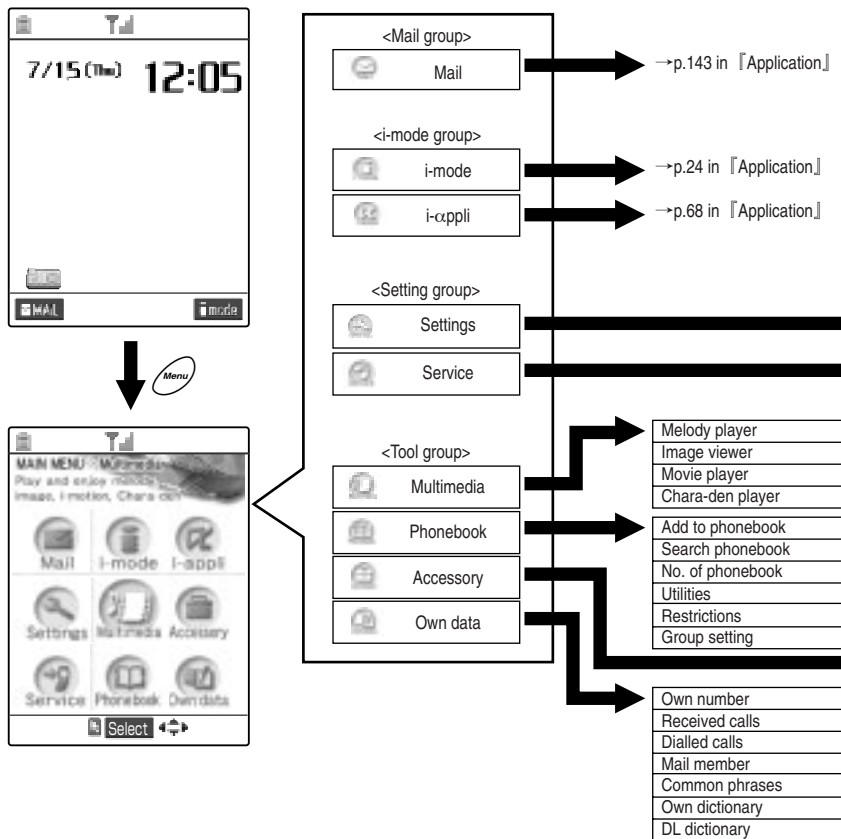

Compatible with Multi task

The FOMA terminal supports "Multi task" that enables you to use multiple functions at the same time: up to three functions from the main menu groups. While the multi task function is used, the in-use groups of the menus are enclosed with a box. For details of multi task, see p.267.





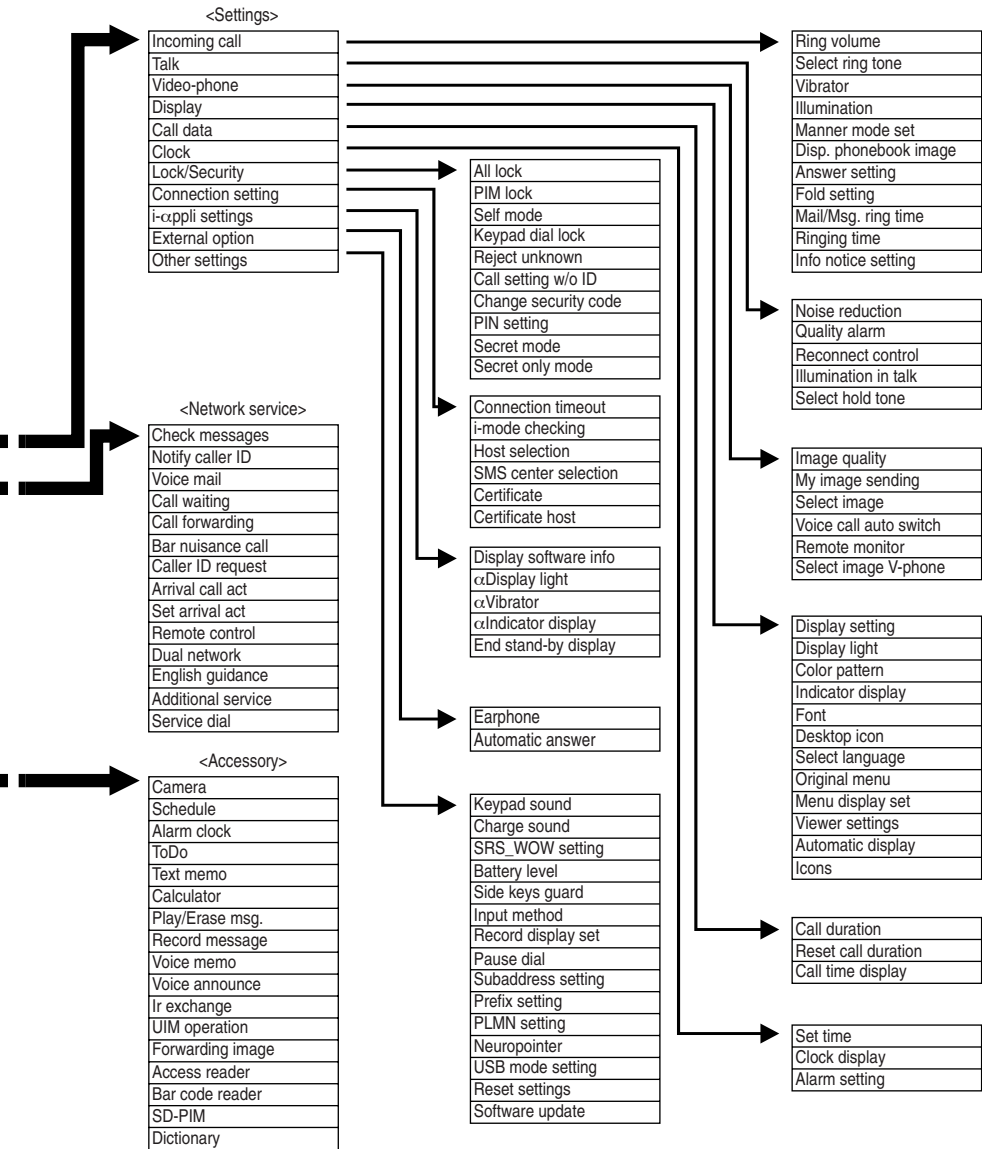



In-use groups are enclosed with a box.



Menu Operations

In the standby display, press  to display the main menu. Select a high level icon from the main menu to display the middle item menu. From the middle item menu, select the desired detail item to display a setting screen or message for checking. Set a function or check the setting according to the menu.

- To select the menu or item quickly, press the dial key with the same number as the desired item <Direct key selection>. This manual uses the following way to explain item selection: “Press  to highlight the item and then press  [Select].”
- Pressing  + the menu number also calls up a setting screen quickly. For details, see “Menu Function List” (p.355).
- After finishing the function settings, the detail item selection screen appears. Pressing  terminates the menu option and the screen returns to the standby. Other activated menu functions are displayed during the multi task.
- To cancel the menu operation, press . The setting operation is canceled and the standby display or the previous screen reappears. Depending on the menu, a message asking whether to void the setting being made or not may appear. In that case, press  to clear the message.
- To operate the menu function, follow the steps below:

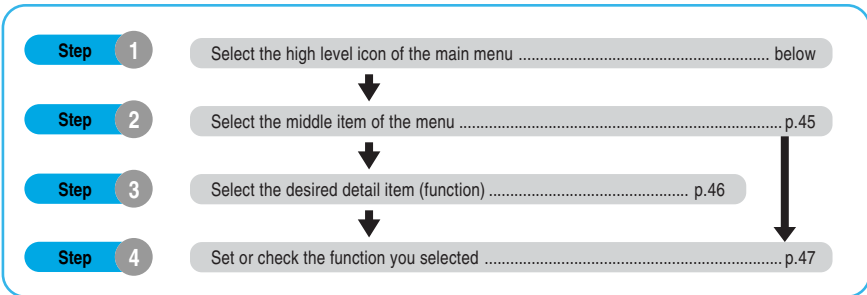

<Example: Setting the flashing color of the “Illumination in talk” function>

Step 1 Select the high level item of the main menu

1 Press .

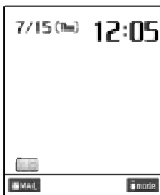

The main menu containing nine high level icons appears. The selected high level icon is embossed in different color.

2 Press to select a high level icon.

After selecting a high level icon, the guidance for the selected icon appears.

When scrolling the guidance continuously

Press and hold down .

When no key is pressed for 15 seconds or more

The main menu closes and the previous screen reappears.

When using the Neuropointer

How to use the Neuropointer → p.35



Guidance for the high level icon

3 Select (Settings), and then press [Select].

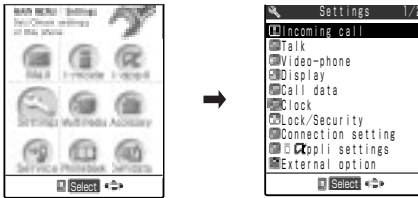

The middle item list screen appears.

NOTE

- You can set the main menu so as not to display guidance in “Menu display set”. → p.243

Step 2

Select the middle item of the menu

1 Press to select the middle item of the menu.

The selected middle item is highlighted.

To scroll items continuously

Press and hold down .

2 Select “Talk”, and then press [Select].

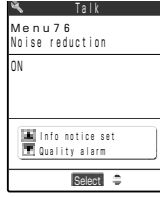
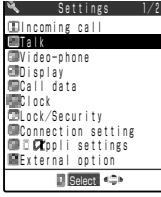

The detail item selection screen (details screen) of “Talk” menu appears.

Step

3

Select the desired detail item (function)

1 Press to select the desired detail item (function).

The details screen of the selected detail item (function) appears. You can check the setting status or menu number of the selected function in the details screen of the detail item.

To scroll items continuously

Press and hold down 

To change the details screen to the list screen

Menu display set → p.243

2 Select “Illumination in talk”, and then press [Select].

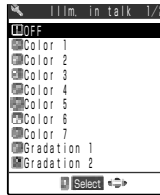
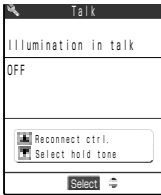

Illumination in talk setting screen appears.

Entering the security code

Depending on the functions, the security code entry screen may appear before the details screen of the selected function.

To display the details screen, enter the security code. → p.192

1 Enter the 4- to 8-digit security code, and then press [Set].

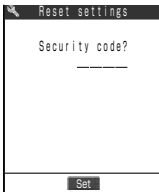

Entered numbers are displayed by “_”.

When the correct security code is entered, the details screen of the function appears.

When incorrect security code is entered

A message notifying you that wrong numbers have been entered appears. Enter the correct security code again.

To set the selected function, there are various ways: selecting an item from the list display, selecting “YES/NO” (p.48), entering numbers (p.48) or marking a checkbox (p.48).

- Depending on the functions, you may have to select a more detail item.
- You cannot select some functions due to settings or other setting conditions.







1 Press to select the item you want to set.

The selected item is highlighted.

To scroll items continuously

Press and hold down .

When items appear in multiple pages

“Current page/Total pages” appears in the upper right corner of the screen. Press  while the top item is selected to display the previous page. Press  while the bottom item is selected to display the next page. To scroll the display by page, press  (or ) for the previous page, press  (or ) for the next page.

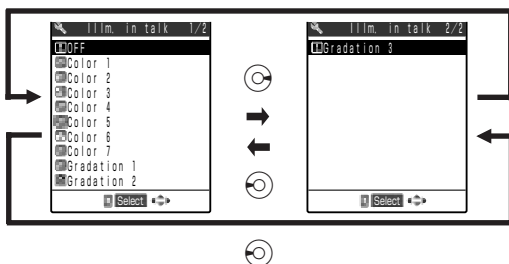

2 Press [Select].



The selected item is set.

3 After operation, press .

The menu operation completes and the standby display reappears. However, it is except when the multi task is being used.

Selecting “YES/NO” or “ON/OFF”

Depending on the functions, you may have to select “YES/NO” or “ON/OFF” from the screen.





- 1 Press  to select “YES” (or “ON”) or “NO” (or “OFF”), and then press  [Select].



The selected item is set.

Entering numbers

Depending on the functions, you may have to enter numbers in the screen.

- 1 Enter numbers by pressing   to  , and then press  [Set].

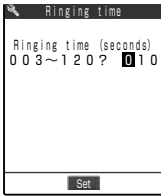

The entered numbers are set.

It may be automatically set if you enter numbers for specified digits. In this case, you do not need to press  [Set].

To enter a 1-digit number in a 2-digit number entry screen

First press , and then enter the desired number.

Enter a 3-digit number in the same manner.

Marking a checkbox

Depending on the functions, you may have to mark a checkbox in the screen. Such a screen mainly appears when selecting multiple items.

- 1 Press  to select (checkbox) to mark.

- 2 Press  [Select].

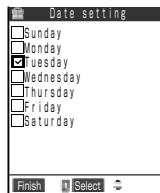
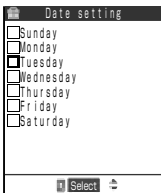



The checkbox changes from to . This is the status of a selected checkbox.





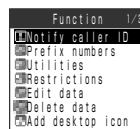
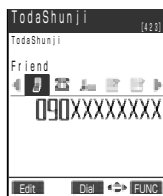

Press  [Select] to toggle and .

When “Finish” appears as a soft key, pressing  [Finish] selects the item selected.

Function menu

When operating a function that can store, edit or delete, “FUNC” appears as a soft key. Press  [FUNC] to display the function menu. Press  to highlight the item which you desire from the function menu, and then press  to select the item.



- When an item appears in multiple pages, “Current page/Total pages” appears in the upper right corner of the function menu. Press  while the top item of the function menu is selected to display the previous page. Press  while the bottom item is selected to display the next page.
To scroll the display by page, press  (or  [Home]) for the previous page, press  (or  [Memo/Check]) for the next page.
- The displayed function menu differs depending on the function in operation.
- You may not select some functions due to settings or other conditions. Unavailable functions are grayed out.

Instructions for menu operations

In this manual, instructions for menu operations are described as follows:

■ The notation for selecting function

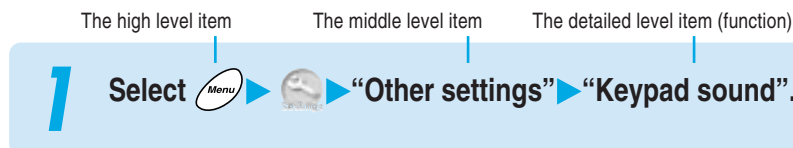

Example: How to select “Keypad sound” from “Settings”.

The notation for this manual:



The actual operations:

1 Press  while the standby display is displayed.

2 Press  on the main menu to select , and then press  [Select].

3 Press  on the middle item selection screen to select “Other settings”, and then press  [Select].

4 Press on the detailed item selection screen to select “Keypad sound”, and then press [Select].

■ The notation for setting function

Example: How to set “Restrictions” for your phonebook.

The notation for this manual:

3 Select the phonebook entry you want to check for the phone number.



The phone number of the selected entry appears.

To cancel the Restrictions setting

Select the phone number you want to cancel.

The actual operations:

1 Press on the list screen of the phonebook to select the phone number you want to check.

2 Press [Select].

■ The notation for selecting menus continuously

Example: How to add to phonebook

The notation for this manual:

2 Select “Add to phonebook” - “Phone”.

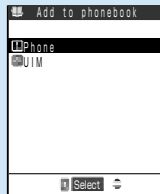
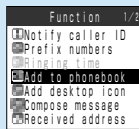

To store the phone number in the FOMA card
Select “UIM”.

The actual operations:

1 Press to select “Add to phonebook” and press [Select].

2 Press to select “Phone” and press [Select].

Setting the FOMA Card

The FOMA card is an IC card that contains private information such as your phone number. By inserting the FOMA card into the FOMA terminal, you can carry out communications including a voice/videophone call, i-mode, mail exchange and packet data communication. In addition, you can use multiple FOMA terminals according to applications by switching your FOMA card.

- You can also save data such as phonebook entries and SMS messages in the FOMA card.
- You can set "PIN1" and "PIN2" codes for the FOMA card. →p.194
- For detailed handling, refer to the manual for the FOMA card.

Inserting/Removing the FOMA card

Before inserting or removing the FOMA card, first turn the power off and remove the battery pack. When inserting or removing the FOMA card, be careful not to touch or scratch the IC accidentally.

■ Inserting

- 1** Put the IC side downward and put the FOMA card into the card inserting slot as shown below.

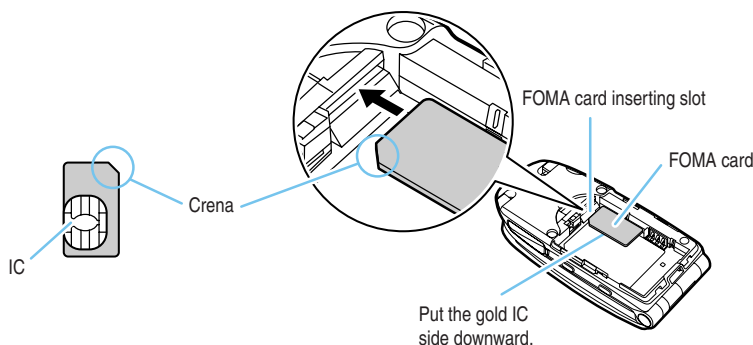

- 2** Insert the FOMA card until it is fixed.

Check that the metallic segment on the lock lever is located at the left edge as shown below.

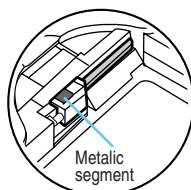

When properly installed

Removing

1 Slide the lock holding the FOMA card.

Be careful not to touch the FOMA card with your fingers.

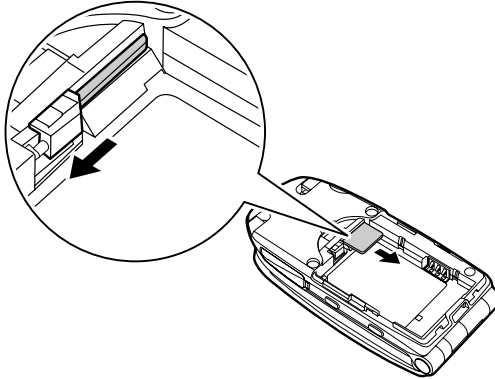

2 The FOMA card is ejected a little. Pull it out straight carefully.

Be careful not to drop the FOMA card when removing it.

NOTE

- Note that if the FOMA card is inserted forcibly, it may be damaged.
- Be careful not to lose the removed FOMA card.
- Do not remove the FOMA card forcibly. It may be deformed or damaged.
- If the FOMA card is difficult to remove, push it until it is fixed and then slide the lock again.

PIN codes for the FOMA card

<PIN1/PIN2 codes>

You can set two PIN (Personal Identification Number) codes, PIN1 code and PIN2 code, for the FOMA card.

PIN1 code is a 4- to 8-digit PIN code to be entered every time the FOMA terminal is turned on to prevent any unauthorized use by third parties. By entering the PIN1 code, you can make/receive calls and operate various communication functions.

PIN2 code is a 4- to 8-digit PIN code to be entered when user authentication is required for online services such as accessing a site or the Internet. This FOMA terminal uses the PIN2 code when you perform the user certificate operation (issuing the user certificate to use FirstPass) and access a FirstPass-compatible site. →p.47 and p.49 in 『Application』

- The default setting for the PIN1 and PIN2 codes is "0000".
- You can change the PIN1 and PIN2 codes. →p.196
- When you purchase a new FOMA terminal and insert your current FOMA card, use the PIN1 and PIN2 codes you set to the current card.

FOMA Card Operational Restriction Function

The FOMA card operational restriction function is a security function to protect your data and files. When you download data from sites or Web pages or receive files attached to i-mode mail, the FOMA card operational restriction function is automatically set. Data and files with this function set are accessible for viewing, playing, editing and attaching to mail and transmitting data via the Infrared communication function only when the FOMA card used for downloading such data or file is inserted.

If you replace the FOMA card with another one, the “” mark is attached with data and files with this function set and the operation above-mentioned does not work.

- Target data and files for the FOMA card operational restriction function are as follows:
 - i-appli, melody, image, Chara-den, downloaded dictionary downloaded from sites or Web pages
 - i-motion downloaded from sites or Web pages
 - Screen memo containing melody, image, i-motion, Chara-den, downloaded dictionary
 - File (melody/image/movie or i-motion) attached to or pasted in i-mode mail in Inbox
 - File (melody/image/i-motion, except for data created or shot with the FOMA terminal) attached to i-mode mail in Outbox/Draft
 - Msg. Request/Free with attached or pasted file (melody/image)
 - Images inserted into the message of decorated mail.
- You can move or delete data and files with this function set even when other FOMA card is inserted.
- Data received via the Infrared communication function, data transmission (OBEX) function or a miniSD memory card and the operation above, does not work and pictures (still images)/continuous multiple pictures/movies shot with the built-in camera are not targeted by this function.

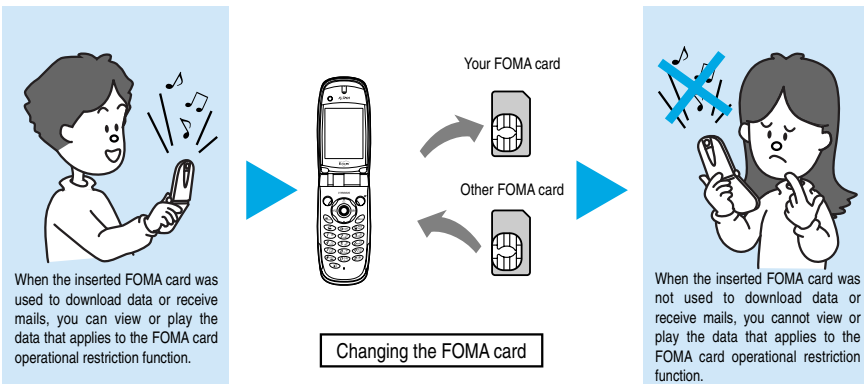

NOTE

- When data or a file with this function set is set to “Display setting” or “Select ring tone”, if you remove your FOMA card or replace it with another one, these settings are reset to the default settings. For example, even if “Melody A” that applies to the FOMA card operational restriction function is specified as a ring tone, the default ring tone sounds when you receive a call. When you reinsert your FOMA card, the FOMA terminal sounds “Melody A” for an incoming call.
- Pre-installed i-αpli can be subjected to this function when it is upgraded or re-downloaded from a site after deleted.
- If the FOMA card operational restriction function is set to your terminal, you cannot activate i-αpli or download i-motion from the mail detail screen of i-mode mail.
- If you replace the FOMA card with another one, in Image viewer or Movie player, an image and a movie with FOMA card operational restriction set are displayed as the right image.



FOMA Card Versions

There are 2 versions in the FOMA card. Please note that there are the following functional differences from “FOMA card (green)” when you use “FOMA card (blue)” on the FOMA terminal.

Feature	FOMA card (blue)	FOMA card (green)	See page
Max number of digits for a phone number to be stored in the FOMA card's phonebook	20 digits	26 digits	p.106
User certificate operation to use FirstPass	Not available	Available	p.49 in 『Application』
WORLD WING	Not available	Available	below

About WORLD WING

WORLD WIND is the FOMA international roaming service that enables you to make and receive calls in overseas countries with the same mobile phone number as you use in Japan by replacing “FOMA card (green)” with an overseas mobile phone (GSM method) card for the service. A separate subscription is required to use WORLD WING. Contact the following for more information:

○Inquiries (NTT DoCoMo Group):

From an ordinary (landline) phone:



0120-005-250 (toll free) (in English)

※ You can call this number from any type of phone, including DoCoMo mobile phones and PHS phones.

※ Check the phone number carefully before dialing.

From a DoCoMo mobile phone or PHS phone:

151 (no area code) (toll free) (in Japanese only)

※ You cannot call this number from an ordinary (landline) phone.

Charging the Battery Pack

Getting the best out of your battery pack

To maintain full performance of the FOMA terminal, use the specified Battery Pack N06 for the FOMA terminal.

■ Battery life

- Batteries have a limited service life. Like all rechargeable batteries, the amount of usable time decreases every time the battery is recharged.
- When a fully charged battery pack only lasts half as long as it did when new, it is time to replace it with a new one.
- In general, the service life of a battery pack is about one year. Note that it may be shortened depending on the frequency of use.



Li-ion

To protect the environment, bring used battery packs to NTT DoCoMo, the agency, or the recycle shop, etc.

■ Battery pack charging

- For details, refer to the manuals for the AC Adapter N03 and DC Adapter N03 <optional>.
- To charge the battery pack using the AC adapter or DC adapter, the battery pack must be attached to the FOMA terminal.
- You can receive calls during charging if the FOMA terminal is turned on. However, the battery level will fall during the call and the time required for charging will increase. Charging time will also increase if the "Display light" (p.183) for "Charging" is set to "All time ON".
- When plugging in or out the connector, do it slowly and securely not to apply an excessive force.

■ **Do not charge the battery pack for a long period of time (several days) with the FOMA terminal turned on.**

If you charge the battery pack for a long period with the FOMA terminal switched on, power to the FOMA terminal will be supplied from the battery pack once charging ends. As a result, you will only be able to use the FOMA terminal for a short time and the low-voltage alarm may sound immediately. In this case, recharge the battery pack correctly. Disconnect the FOMA terminal from the AC adapter (or desktop holder) or DC adapter and then set it again for recharging.

Battery usage time

(The battery duration varies depending on the charging time and the deterioration of the battery.)

Continuous talk time	Continuous standby time
Voice call: Approx. 140 min. Videophone call: Approx. 90 min.	Stationary: Approx. 430 hours Moving: Approx. 350 hours

- The continuous talk time is an estimated time you can talk while radio waves are strong enough to send and receive.
- The continuous standby time is an estimated time when radio waves are strong enough to receive properly with the FOMA terminal folded. Note that the actual continuous talk/standby time may decrease by as much as half depending on the following conditions: the battery level, the function settings, ambient environment such as temperature, the status of radio waves (out of service area or weak radio waves). Using i-mode will decrease the talk (communication) and standby times. Even when you do not talk on the phone or use i-mode, creating i-mode mail or starting up downloaded i-appli and i-appli standby display will also decrease the talk (communication) and standby times.
- The standby time in stationary is the average usage time when the FOMA terminal is folded and standing still, while radio waves can be normally received.
- The standby time in moving is the average usage time when the FOMA terminal is folded under condition of "stationary", "moving", and "out of service area" within the area where radio waves can be normally received.
- Loading the miniSD memory card, performing data communication or multi access or using the camera or the light will also shorten the talk (communication) and standby times.

Attaching/Removing the battery pack

- Be sure to turn the FOMA terminal off before replacing the battery pack.
- When a FOMA Card is installed, make sure it is properly installed (p.51). If the FOMA card is not properly set, the battery pack cannot be attached. If the battery pack is attached forcibly, the FOMA card may be damaged.
- For details, refer to the manual for the Battery Pack N06.

Attaching

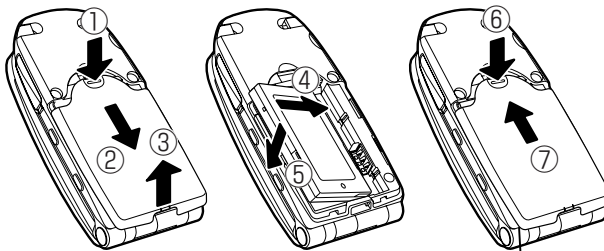

Make sure the rear cover and the FOMA terminal (body) is securely locked.

1 While pressing down the knob of the rear cover in the ① direction, slide the cover in the ② direction and then pull up in the ③ direction to remove it.

2 With the caution label on the battery pack facing upwards, insert it into the notches of the FOMA terminal (body) in the ④ direction and press the battery pack down in the ⑤ direction to clip it into the FOMA terminal. Check that the tabs on the battery pack are slotted into the notches of the FOMA terminal.

3 Place the rear cover into the cavity in the FOMA terminal (body), keeping the rear cover open in about 3 mm. Then push the rear cover in the direction of arrow ⑥ to clip it into the FOMA body, and slide it in the direction of arrow ⑦ until you hear a click.

Removing

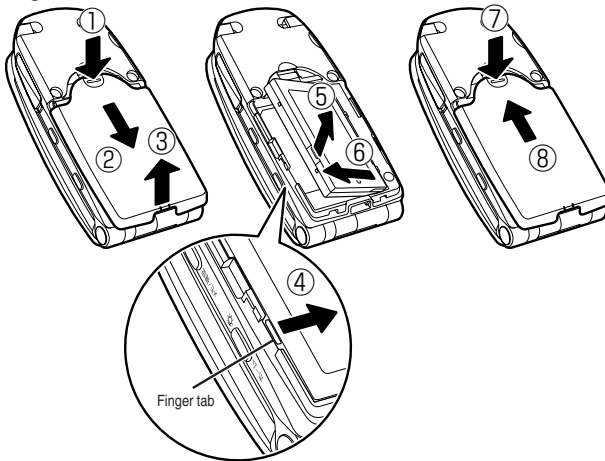

1 While pressing down the knobs of the rear cover in the ① direction, slide the cover in the ② direction and then pull up in the ③ direction to remove it.

2 While pressing down in the ④ direction, lift the tabs of the battery pack up in the ⑤ direction, and then remove it in the ⑥ direction.

3 Place the rear cover into the cavity in the FOMA terminal (body), keeping the rear cover open in about 3 mm. Then push the rear cover in the direction of arrow ⑦ to clip it into the FOMA body, and slide it in the direction of arrow ⑧ until you hear a click.

Charging the battery pack with the AC adapter

Connect the AC Adapter N03 to the FOMA terminal to charge the battery pack.

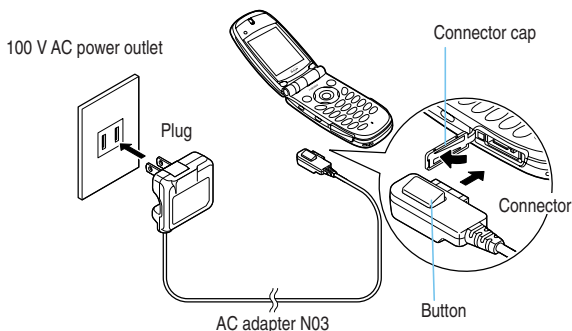



1 Open the external connector cap of the FOMA terminal.

2 Plug the AC adapter connector into the FOMA terminal's external connector in the direction as shown above.

3 Plug the AC adapter into a power outlet.



When the FOMA terminal is turned off

Charging starts. The charge lamp lights in red and “” flashes. The charge lamp turns off and “” lights when charging ends.

Standard charging time

Approx. 120 min.

4 When charging is completed, remove the AC adapter connector from the FOMA terminal while pressing the connector button. Then unplug the AC adapter from the power outlet.

5 Close the external connector cap of the FOMA terminal.

NOTE

- Be sure to put Battery Pack N06 into the FOMA terminal before charging the battery.
- The standard battery charge time is for the FOMA terminal turned off. You can charge the battery with the power ON, but it takes longer to charge the battery than it does with the power off.
- If the battery is dead or the power is off with full data in the phonebook, etc., the battery charging lamp may not glow right away, but the battery charge has actually started.
- The AC adapter, FOMA terminal and battery pack may become warm during the battery charge, it is not abnormal.

Charging the battery pack with the desktop holder

Use the AC Adapter N03 and the Desktop Holder N04 to charge the battery pack. As you can charge the battery pack by simply placing the FOMA terminal in the desktop holder without opening its connector cap, it is convenient.

- You cannot charge the battery pack separately from the FOMA terminal.
- The desktop holder has a screw hole for fixation on the bottom.

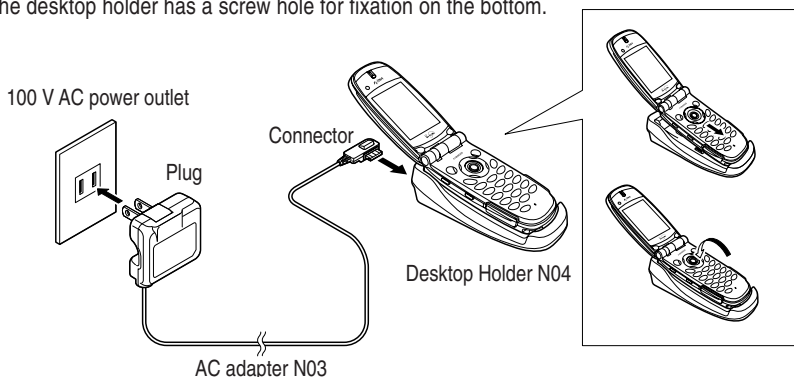

1 Plug the AC adapter connector into the terminal on the rear of the desktop holder in the direction as shown above.

2 Plug the AC adapter into a power outlet.

3 Place the FOMA terminal firmly in the desktop holder as shown above.

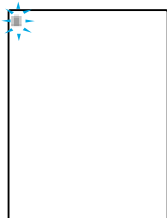

When the FOMA terminal is turned off

Charging starts. The charge lamp lights in red and " " flashes. The charge lamp turns off and " " lights when charging ends.

Standard charging time

Approx. 120 min.

- After charging ends, hold down the desktop holder, grip both sides of the FOMA terminal and lift it up in the arrow direction from the holder.

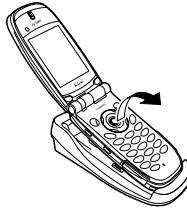

NOTE

- Be sure to put Battery Pack N06 into the FOMA terminal before charging the battery.
- The standard battery charge time is for the FOMA terminal turned off. You can charge the battery with the power ON, but it takes longer to charge the battery than it does with the power off.
- If the battery is dead or the power is turned off with full data in the phonebook, etc., the battery charging lamp may not glow right away, but the battery charge has started.
- The AC adapter, desktop holder, FOMA terminal and battery pack may become warm during the battery charge, it is not abnormal.

Charging the battery pack with the DC adapter (optional)

Connect the DC Adapter N03 (optional) with the FOMA terminal to charge the battery pack. The DC adapter supplies the power for charging from the cigarette lighter socket (12V/24V DC) in a car.

- The DC adapter is exclusively for negative-grounded vehicles. Never use it in positive-grounded vehicles.

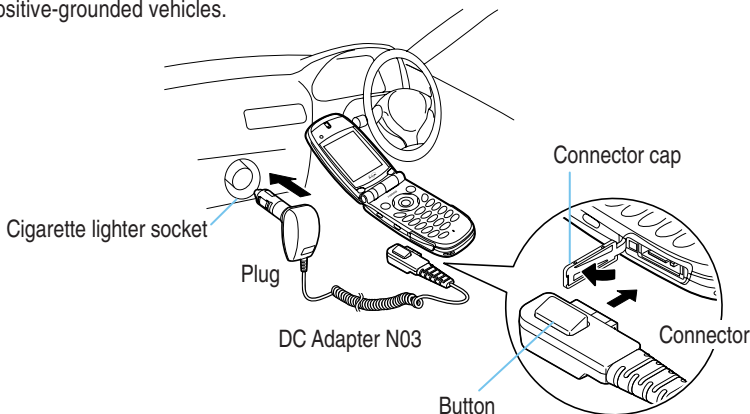

- Open the external connector cap of the FOMA terminal.

- Plug the DC adapter connector into the FOMA terminal's external connector in the direction as shown above.

3 Plug the DC adapter into the cigarette lighter socket in your car.

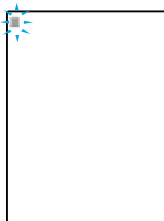

When the FOMA terminal is turned off

Charging starts. The charge lamp lights in red and “” flashes. The charge lamp turns off and “” lights when charging ends.

Standard charging time
Approx. 120 min.

4 When charging is completed, remove the DC adapter connector from the FOMA terminal while pressing the connector button. Then unplug the DC adapter from the cigarette lighter socket in your car.

5 Close the external connector cap of the FOMA terminal.

NOTE

- Depending on your car type, the DC adapter may not be connected.
- When the vehicle engine is not running, use of the DC adapter may drain the car battery. Always start the engine before using the DC adapter. Always disconnect the DC adapter connector from the FOMA terminal and unplug the DC adapter from the cigarette lighter socket when you are not using the DC adapter or when you are not in the car.
- The DC adapter uses a 2A fuse. If the fuse (2A) blows and you need to replace it, always use a fuse with the same specifications. Fuses (2A) are consumable items and replacement fuses can be purchased at your local car accessory shop, etc.
- Please put Battery Pack N06 into the FOMA terminal before charging the battery.
- The standard battery charge time is for the FOMA terminal turned off. You can charge the battery with the power ON, but it takes longer to charge the battery than it does with the power off.
- If the battery is dead or the power is turned off with full data in the phonebook, etc., the battery charging lamp may not glow right away, but the battery charge has started.
- The DC adapter, FOMA terminal and battery pack may become warm during the battery charge. However, it is not abnormal.

Power On/Off

- When you start using the FOMA terminal for the first time (or it has been left unused for a long period), charge the battery. Use the specified AC adapter or DC adapter (optional) for charging.
- No date and time is set by default. Set them in “Set time”. →p.65

Turning the power on

1 Hold down  for 1 second or more.

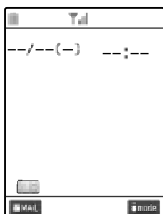

The date/time and the battery level appear (the standby display).

When “” appears

You are outside the FOMA service area or in a place where radio waves do not reach. Move to a place where the radio reception level indication such as “” lights.

Even if the reception level is strong with “” icon displayed and you are not moving, a call may be disconnected.

When you try to use the phonebook, mail or other function immediately after the power on

A message notifying you that the FOMA cannot start up because data is presently being downloaded in a FOMA card may appear. In this case, retry the operation after a while.

When changing an image displayed on the standby display to another image or calendar

“Display setting” →p.177

When the PIN1 code entry set is set to “ON”

The Enter PIN1 code screen is displayed. Enter the correct PIN1 code to display the standby display. →p.197

When “i-αppli stand-by display” is set

A message asking whether to start up “i-αppli stand-by display” (p.86 in [Application]) appears.

Turning the power off

1 Hold down  for 2 seconds or more.



The shutdown screen appears and the power is turned off.

When turning the power off during i-mode

“” flashes and it may take a little longer before the FOMA terminal turns off.

Entering the PIN1 code

When “PIN1 code entry set” (p.195) of “PIN setting” is set to “ON”, enter your 4- to 8-digit PIN1 code after the power is turned on. The default setting is “OFF”.

1 Enter your current PIN1 code.



The PIN1 code entered is displayed by “_”.

2 Press [Set].

When the correct PIN1 code is entered, the standby display appears.

If the PIN1 code is locked after three incorrect entries

Cancel the PIN lock →p.198

Checking the Battery Level

You can check the remaining battery level in the following two ways. The indicated battery level is reference only.

Checking the battery level with icon

When the FOMA terminal is turned on, the icon indicating the remaining battery level is automatically displayed. Check the current battery level with the displayed icon.

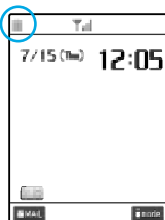

 (green) : Full charge

 (green) : Low charge

 (red) : Almost empty. Charging the battery is recommended. →p.55

Checking the battery level with sound and graphics (animation)

The current battery level is indicated by sound and graphics (animation).

1 Select “Other settings” ▶ “Battery level”.

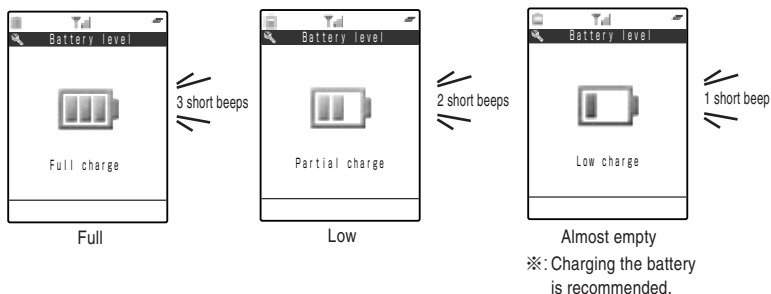

The battery level check screen is displayed, and beeps sound in accordance with the level. The battery level graphics disappears in about three seconds.



NOTE

- The beeps do not sound when “Keypad sound” is set to “OFF” or in the Manner mode.

When the battery runs out <Low-voltage alarm>

When the battery runs out, the screen as shown on the right flashes and the low-voltage alarm sounds. The alarm sounds for about 10 seconds and the power is turned off in about one minute. To stop this alarm, press any keys other than  [Home] or  [Memo/Check].

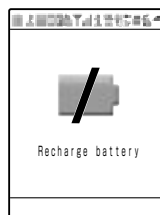

NOTE

- If the battery runs out during a call, the Recharge battery screen above is displayed and short tones “pip-pip-pip” sounds. Note that the call will be disconnected in about 20 seconds and the power turns off in about one minute.
- When “Ring volume” for “Phone/Video-phone” is set to “Silent”, the low-voltage alarm sounds at a constant volume.
- During the “Manner mode”, when the manner mode operation is set to “Manner mode”, “Super silent”, or “Silent” for “Phone vol.”, “OFF” for “LVA tone” in “Original”, no low-voltage alarm sounds.

Switching the Screen Display to English

Default setting | Japanese

You can switch the function name and messages showed between English and Japanese in the display or indicator display .

- When “Japanese” is set, “Language” appears as the function name, and if “English” is set, “Select language” appears.

1 Select   “ディスプレイ” ▶ “Language (Select language)”.



Displayed in Japanese

To switch the display from Japanese to English
Select “English”.



Displayed in English

To switch the display from English to Japanese
Select “日本語”.

NOTE

- If the FOMA cards are replaced, the “Language (Select language)” setting may be changed depending on the current card setting.

Setting the Date and Time

No date or time is set by default. After setting the date and time in “Set time”, the date and time you set appears on displays such as the standby display and indicator display. In addition, you can use various functions such as the schedule.

- This function allows you to set the date and time between 00:00 in January 1, 2003 and 23:59 in December 31, 2099. The date and time will not be updated after 23:59 in December 31, 2099.
- If you set up the clock, the date and time will be displayed in functions such as Standby display, Redial record/Received calls record and Mail.
- If you set up the clock, you will be able to use functions to manage the date and time such as “Alarm clock” and “Schedule”.







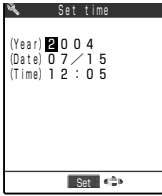





<Example: Setting July 15, 2004, 12:05>

1 Select   "Clock"  "Set time".

2 Enter the year, month, date and time (24-hour format).



Press  to move the highlighted display, and then enter the numbers with the dial keys.

Press , , , , , , , , , , , .

3 When you finished entering the date and time, press  [Set].

NOTE

- If you enter the date and time outside the scope of this FOMA terminal, the date and time are not set. Enter the correct date and time again.
- You can set the date and time during a call.
- If you do not set the date and time, you cannot use functions such as the (authentication) function of SSL communication and the function of automatic run of i-cppli, and you cannot acquire the i-motion with expiration and replay period.
- The FOMA terminal incorporates an built-in backup battery. The date and time you set are retained by the built-in backup battery, so the settings are not lost when you replace the battery pack. However, the date and time may be reset if the battery pack is removed for two weeks or more. In this case, charge the FOMA terminal, then set the date and time again. Charging the battery pack also charges the backup battery.

Notifying Your Phone Number to the Other Party

If the other party's phone is a digital terminal capable of displaying the caller ID, you can display your phone number (caller ID) on the other party's phone (display) when you make a voice or videophone call. Since the caller ID is your important information, please handle with care when you send your caller ID. You can use the following ways to set whether you notify your caller ID to the other party or not.

Function name	Description	See page
Notify caller ID	Set whether to notify your caller ID at one time for all the calls you make.	p.285
"186" / "184" dial	Set whether to notify your caller ID for each call you make by dialing "186" or "184".	p.67
Notify caller ID	Set whether to notify your caller ID from the function menu for each call you make.	p.124

Dial by attaching “186” / “184” before the other party’s phone number

Every time you make a call, you can prefix “186” to the other party’s phone number when you send your caller ID, or “184” when you send no caller ID.

● For international calls, prefixing “186”/“184” is not available.

■ Notifying your caller ID

Voice call : 186 - - 

Videophone call : 186 - - 

■ Notifying no caller ID

Voice call : 184 - - 

Videophone call : 184 - - 

NOTE

- You can also use “*31#” instead of “186” and “#31#” instead of “184”.
- When you hear the guidance asking you to send your caller ID, make a call again with the prefix of “186” or “*31#”.

Own number

Checking Your Own Phone Number



You can display and check your phone number (own number) stored in your FOMA card.

1 Press  .



You can also display your own number by selecting “Menu” - “Own number”. →p.42

NOTE

- Your data (name, home phonenummer, home address and mail address, etc.) can be stored. →p.239
- When an i-mode mail address is stored as your own data, press  to check the stored data.
- An i-mode mail address can be checked by selecting “ Menu” - “Options” - “Mail settings” - “Confirm Mail Address” from the i-mode menu.

Blocking Nuisance Calls

With the FOMA terminal, you can use the following functions to block nuisance calls or malicious calls such as “one-ring calls”.

Function name	Description	See page
Ringing time	Sets the FOMA terminal not to start the ringing operation until the set period has elapsed. You can make a setting so that the missed call record will not list incoming calls that do not meet the set ringing time. This is an effective countermeasure against “one-ring calls” because no missed calls with short ringing time are recorded.	p.140
Reject unknown	Sets the FOMA terminal to reject incoming calls from the phone number not stored in the phonebook. This function is valid for callers whose phone numbers are notified. To reject incoming calls from callers without sending their phone numbers, set “Call setting w/o ID”.	p.144
Call setting w/o ID	Sets the FOMA terminal to reject incoming calls from callers whose phone numbers are not notified. This function rejects or accepts incoming calls depending on the reason for no caller ID. Such reasons include “Not supported”, “Payphone” and “User unset”.	p.145
Call rejection	Sets the FOMA terminal to reject incoming calls from specified phone numbers. Incoming calls from those specified numbers are listed in the received calls record. This function is valid for callers whose phone numbers are notified. To reject incoming calls from callers without sending their phone numbers, set “Call setting w/o ID”.	p.141
Bar nuisance call service	By storing a number to be blocked immediately after receiving the call, the FOMA terminal plays an announcement and rejects the future calls from that number. Since such calls are blocked through the mobile phone network, they are not recorded in the received calls record of the FOMA terminal. Even if you receive calls from the same phone number without caller IDs, the FOMA terminal rejects those calls. A separate subscription is required (subject to the monthly charge).	p.284

NOTE

- Do not call back unfamiliar phone numbers. Particularly, returning calls with your caller ID notified may cause unnecessary problems.
- When the following functions for blocking nuisance calls are set at the same time, they are prioritized as follows. ① has the top priority.
 - If you receive calls from callers whose phone numbers are notified.
 - ① Bar nuisance call service
 - ② Reject unknown/Call setting w/o ID
 - ③ Ringing time
 - If you receive calls from callers whose phone numbers are not notified.
 - ① Bar nuisance call service
 - ② Call rejection
 - ③ Ringing time



Basic Operations

Making/Receiving Phone Calls	70
Settings for When You Cannot Take Calls	81
Making/Receiving Videophone Calls	87
Using the Phonebook	106
Setting Manner Mode	135

Making a Call

Dialing a phone number to make a voice call.

- Before making a call, make sure that there is sufficient battery charge remaining and that the reception is good.
- You cannot make calls to internal office number, etc. which those do not allow you to enter an area code from your FOMA terminal.

1 Dial the other party's phone number, starting with the area code.



Even if you are within the same area code as the number you are dialing, you must enter the full number, including the area code.

[Area code]-[City code]-[Subscriber number]

To call a mobile phone

090-XXXX-XXXX

or

080-XXXX-XXXX

To call a PHS phone

070-XXXX-XXXX

2 Press .

“” lights.

The phone number immediately disappears from the display and reappears from the right side of the screen, and then a call is made.

You can also make a call by pressing  [Dial].

If you hear a busy tone

The other party is engaged on the phone. Press  and call again later.

If you hear an announcement saying that the call did not go through







The other party's mobile phone or PHS phone is not turned on or is in a location of no radio reception. Press  and try again later.

If you hear an announcement requesting your phone number

The other party's Caller ID request service is set to “Activate”. Set your FOMA terminal to notify your phone number and call again. →p.66

3 When you finish the conversation, press .

NOTE



- You can still make a call even during i-mode or while you are sending or receiving mail.
- If you switch to a screen other than the talking screen during a call, press  to return to the talking screen.
- You can still make a call even if you switch the order of steps 1 and 2. If you have entered the wrong phone number, press  to erase the display, and then dial again.
- Press   while making a call or talking switches to the handsfree mode. When the handsfree mode is set, you can talk while listening to the other party's voice from the speaker. However, since the other party's voice will play over the loudspeaker during the handsfree mode, always move to a location where this will not bother others before switching to the handsfree mode. Pressing   again to cancel the handsfree mode.
- You can send a still image photographed with the built-in camera during a call to the other party (Speed photo mail). →p.169 in [Application]
- When the communication line is busy, “Please wait” may be displayed. In this case, call again later.

If you make a mistake when entering a phone number

■ To insert a number

Press  to move the cursor to the number on the right side of where you want to insert a number, and then press the number.

■ To delete a number

Press  to move the cursor to the number you want to delete, and then press . If you hold down  for 1 second or more, all numbers on the right of the cursor will be deleted with the cursor position included.

■ To correct the entire number

Position the cursor at the beginning or end of the number and hold down  for 1 second or more. The standby display will return.

Putting the current call on Hold

<Holding>

You can put the current call on hold.

1 Press during a call.



The caller hears a hold tone.

To end a call while the call is on hold

Press .

If the caller hangs up while the call is on hold

The call ends.

2 When you are ready to answer the call, press , or [Answer].

NOTE

- You can set a hold tone which the other party hears during a call in the "Select hold tone". →p.158
- When you set "Phone/Video-phone" in "Ring volume" to "OFF", or set "Manner mode" or "Super silent" while the manner mode is set, or set "Phone vol." to "OFF" in "Original", the hold tone does not sound (mute).
- If the "Fold setting" (p.160) is set to except "End the call", you can put a call on hold with the FOMA terminal folded.

Dialing a Previously Dialed Number

You can redial previously dialed numbers in a voice/videophone call. This is useful for redialing someone whose phone was busy last time you called.

- The FOMA stores up to 30 numbers of voice/videophone call.
- If you call the same number in the same Phonebook more than once, that number is treated as one record and the most recent call is stored.
- Once the number of records exceeds 30, each new record overwrites the oldest record.
- Calls made by calling up the Phonebooks stored as secret data are not saved as Redial records.

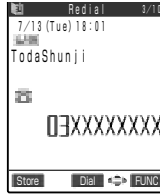

1 Press and select the number you want to redial.



The detail screen of the selected redial is displayed.

The “current redial number/total number of redials” are displayed on the upper right side of the screen. The smaller the number is, the more recent the call was made.

To display the redial before and after the current one

Every time you press  on the detail screen of the redial, the redial before the current one is displayed like the 2nd redial, 3rd redial.... Every time you press , the redial after the current one is displayed like 30th redial, 29th redial....

For the telephone number registered in the phonebook

If a name has been registered, it is also displayed.

2 Press or [Dial].

To make a videophone call

Press .

3 When you finish the conversation, press .

NOTE

- While “PIM lock” is set, only phone numbers are stored even in the case of calls to parties whose names or icons are stored in the Phonebook.
- Phone numbers you have dialed are also stored in the “Dialed calls” (p.151). In the “Dialed calls”, information on each call is recorded as a separate record even when you redialed the same phone number.
- No dialed date and time is displayed when the date and time is not set in “Set time”.
- With redial, you can store recorded phone numbers in the phonebook or compose and send i-mode mails from the function menu in the same manner with dialed record/received call record. →p.151

Deleting a redial record

Turning the FOMA terminal off does not delete the Redial records. To prevent other people from viewing your Redial records, you must delete them.

1 Display the Redial record you want to delete.

2 Select “Delete this” from the function menu.



To delete selected Redial records

Select “Delete selected” from the function menu, and then select the records you want to delete.

To delete all Redial records

Select “Delete all” from the function menu.

NOTE

- If you perform “Delete all”, both “Redial” and “Dialled calls” are deleted. Note that if you perform “Delete this” or “Delete selected” on the Redial, the Dialled calls record is not deleted. About dialed record → p.151

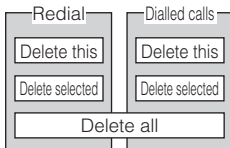

WORLD CALL

Making International Calls

WORLD CALL is a service provided to subscribers to NTT DoCoMo’s digital mobile phone services that allows them to make international calls with their phones.

About WORLD CALL

- You can make calls to about 220 countries and regions around the world.
 - Charges for “WORLD CALL” will be billed together with your monthly FOMA call charge.
 - There is no application or monthly charge for this service.
- All FOMA subscribers can use “World Call” service without additional subscription.

Changing the international call dialing procedure

The “My Line” service is not available for mobile communication devices such as mobile phones. For this reason, the “My Line” service is not available when you use the WORLD CALL service to make an international call from the FOMA terminal. The procedure to make an international call from your FOMA terminal has changed as mentioned below in accordance with the introduction of the “My Line” service. Note that the conventional dialing procedure (excluding “010” from the dialing numbers below) is not available.

WORLD CALL	Inquiries	
	 <p>From an ordinary (landline) phone: 0120-005-250 (toll free) (in English) ※ You can call this number from any type of phone, including DoCoMo phones and PHS phones. ※ Check the phone number carefully before dialing.</p>	<p>From a DoCoMo mobile phone or PHS phone: 151 (no area code)(toll free) (in Japanese only) ※ You cannot call this number from an ordinary (landline) phone.</p>

1 Dial 009130 - 010 - Country code - Area code - the other party's phone number.

If the area code begins with “0”, omit the “0” when you dial. However, you must dial “0” when calling general phones in Italy.

2 Press .

3 Press to end the call.

You can use the “International videophone call” by making a call to an overseas customer*1 who uses a certain 3G mobile phone terminal in the videophone call mode after following the above dialing method.*2

※1 : As of June, 2004, you can communicate with Hutchison3GUK (UK) and Hutchison3GHK (Hong Kong).

※2 : Depending on the terminal the international videophone call is going to be connected to, the other party's image displayed on the FOMA terminal may be disrupted or you may not be able to connect to it.

※1・2 : See DoCoMo's homepage for more information.

NOTE

- “009130-010” is already stored in the “Prefix setting” (p.149).
- If your international phone carrier is not NTT DoCoMo, call your international phone carrier for information on how to make international calls.

Making an international call with easy operation

“WORLD CALL” is set to the “Prefix setting” by default so that you can make an international call with a quick operation.

1 Dial the other party’s number.

Dial “Country code - Area code - The other party’s phone number”.

To display the other party’s number that is stored in your phonebook.

How to search phonebook. →p.116

2 Select “Prefix numbers” - “WORLD CALL” from the function menu.

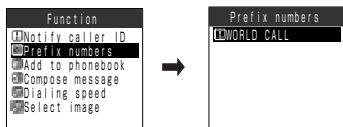

3 Press .

You are connected to an international call.

Receiving a Call

Receiving an incoming voice call

1 When a call comes in, press or [Answer] to receive it.



When a call comes in, the phone rings and the incoming call lamp flashes.

If the “Vibrator” is set to other than “OFF”, the phone vibrates.

To reject an incoming call intentionally

Select “Call rejection” from the function menu.

To forward an incoming call

Select “Call forwarding” from the function menu.

The call will be connected to the forwarding number whether the “Call forwarding” service is set to “Activate” or “Deactivate”.

To connect an incoming call to the voice mail service center

Select “Voice mail” from the function menu.











The call will be connected to the voice mail service center whether the “Voice mail” service is set to “Activate” or “Deactivate”.

To switch to the handsfree mode

Press during a call.

2 When you finish the conversation, press .

NOTE

- Press ,  [Answer] or even any of the following keys to answer an incoming call (Any key answer):  to , , , ,  or . You can set to stop the ring tone by pressing any key. →p.159
- If you press  or  [Memo/Check] during an incoming call, the FOMA terminal enters into the “Manner mode” and activates “Record message” so that you can record the other party’s message. →p.136
- When the caller notifies the caller ID and the caller’s name has already been stored in the phonebook, both the phone number and name appear. If you store an image in the phonebook, the image appears. However, if the caller’s phonebook entry was stored as secret data (p.201), only the caller’s phone number appears with no name and no image. When the caller does not notify the caller ID, the reason for no caller ID informed appears.
- Up to 30 incoming calls can be stored in the “Received calls”. When the caller notifies the caller ID, the caller’s phone number appears. If the caller’s name has already been stored in the phonebook, both the phone number and name appear.
- If you subscribe to the “Call waiting” service and you set “Arrival call act” to “Answer” and “Call waiting” to “Activate”, you will hear a signal tone during a call when another call arrives while you are talking. In this case, you can perform any of the following:
 - Put the current call on hold to answer the incoming call.
 - Forward the incoming call to the voice mail center if you subscribe to the “Voice mail” service.
 - Forward the incoming call to the specified forwarding number if you subscribe to the “Call forwarding” service.
 For details, see p.281.
- When you receive a forwarded call, the phone numbers of the forwarding phone and the caller are displayed. Some source numbers may not be displayed.
- You cannot make calls to a FOMA terminal from internal office numbers, etc. which those do not allow you to enter an area code.

Checking Missed Calls and New Mail

With the FOMA terminal folded, you can check whether you have received missed calls and new mail with sound, vibration, lighting/flashing of the incoming call lamp.

- This function notifies you of the receiving when the “Missed call” or “New mail” desktop icon appears on the standby display.
- You cannot use this function to check a missed call or a new mail in the following cases:
 - ALL lock
 - PIM lock
 - When the Side keys guard is “ON”
 - When the Info notice setting is “OFF”

Setting notification of missed calls or new mail <Info notice setting>

Default setting ON

1 Select   **“Incoming call”** ▶ **“Info notice setting”**.

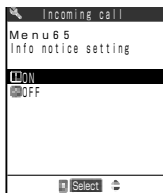

To notify with sound

Select “ON”.

To disable “Info notice setting”

Select “OFF”.

Checking Missed Calls and New Mail

When you press  [Memo/Check] with the FOMA body folded, you can check missed calls and new mails. Checking operation is as follows:

Info notice setting	When there are missed calls or new mail		When there are neither missed calls nor new mail	
	Sound/vibration	Color of the incoming call lamp	Sound/vibration	Color of the incoming call lamp
Sound	Short double tones “pip-pip-pip” sound with about 1 second vibration	The incoming call lamp lights in the color set in “Phone” or “Mail” of the “Illumination” for about 5 seconds. When there are both missed calls and new mails, each color※ lights up alternately.	Short tones “pip-pip-pip” sound with about 0.2 second vibration.	The incoming call lamp flashes in “Color 12” for about 5 seconds.

※: If the incoming call lamp is set to “Gradation”, the lamp flashes in “Color 5” for missed calls and “Color 1” for new mail.

NOTE

- This function cannot check if the i-mode center has stored new mail.
- When the “Vibrator” (p.167) for the “Phone” is set to “OFF”, the FOMA terminal does not vibrate.
- While the manner mode is set (p.135), the FOMA terminal notifies you of missed calls and new mail with vibration without sound. However, if the manner mode operation is set to “Original” and other than “Silent” is set to the “Phone vol.”, the FOMA terminal sounds. If the “Vibrator” is set to “OFF” in “Original”, the FOMA terminal does not vibrate.

Adjusting the Earpiece Volume

Default setting **Level 4**

You can adjust the volume of the other party's voice to any of 6 different levels from "Level 1" (min.) to "Level 6" (max.).

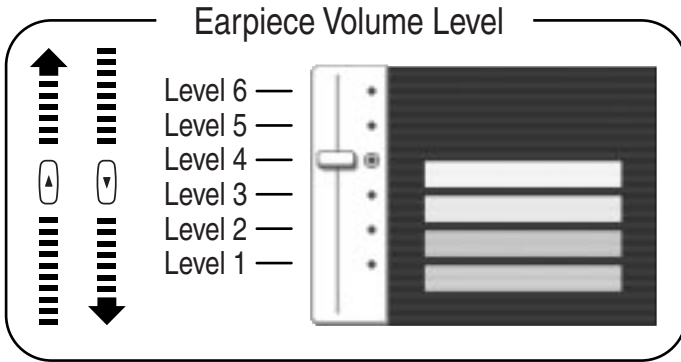

- You can also adjust the volume during a videophone call or in the handsfree mode.
- You cannot adjust the volume when a call is coming in.

Adjusting the earpiece volume during a call

1 Press **▲** or **▼** during a call.

A short beep sounds and the Volume screen is displayed.

2 Adjust the earpiece volume.

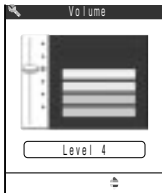

To increase the volume by one level

Press **▲**.

To lower the volume by one level

Press **▼**.



Hold down **▲** or **▼** for 1 second or more to adjust the volume continuously.

If you do not perform any operation for more than 2 seconds or while the earpiece volume display is shown, the volume adjustment is terminated, returning to the call display.

NOTE

- You can adjust the volume by pressing **⏪** or **⏩** for 1 second or more during a call as well.

Adjusting the earpiece volume during standby

1 Hold down  or  for 1 second or more during standby.

2 Press  or  to adjust the earpiece volume.



To increase the volume by one level

Press .

To lower the volume by one level

Press .

Hold down  or  for 1 second or more to adjust the volume continuously.

If you do not press  or  within 2 seconds after displaying the Volume screen, the volume adjustment is terminated, and then the standby display reappears.

Adjusting the Ring Volume

Default setting | Phone/Video-phone: Level 4 | Mail/Message: Level 4

You can adjust the ring volume that notifies you incoming voice/videophone calls, mail or message request/free to any of 6 different levels. You can also mute the ring tone or set it to gradually ring louder (Step).

- You cannot adjust the ring volume during an incoming call.
- The ring volume set in “Phone/Video-phone” in this function will be reflected on following functions; “Movie player”, “Melody player”, “Select ring tone” for voice call or videophone call, alarm sound for “Schedule” or “ToDo”, and the volume to play a melody downloaded from Web pages.
- The ring volume set in “Mail/Message” in this function will be reflected on following functions; “Select ring tone” for mail or Msg. Request and Msg. Free, and the volumes listed in “Mail ring tone” or other functions in utilities.

1 Select   “Incoming call” .

2 Select the item you want to set.

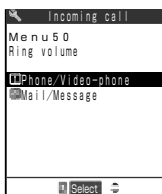

To adjust the ring tone for incoming voice/videophone calls and 64K data communication

Select “Phone/Video-phone”.

To adjust the ring tone for incoming i-mode mail, SMS, message request/free and packet communication

Select “Mail/Message”.

3 Adjust the ring volume.

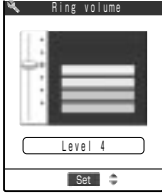

To increase the volume by one level

Press .

To lower the volume by one level

Press .

To set up Step Tone (to turn up the tone gradually)

Press  at Level 6.

If you receive an incoming call at Step Tone, the ring volume becomes louder every 3 seconds from Silence, Steps 1 to 6.

To silence the ring tone

Press  at Level 1.

If the setting is silent, no ring tone will sound.

You can check which functions have been set to “Silent” by the icon displayed on the standby display.

: Set to “Phone/Videophone only”

: Set to “Mail/Message only”

: Set to both “Phone/Videophone” and “Mail/Message”

Hands-free

Hands-free Compliant Devices Ready for Use

By connecting your FOMA terminal with a hands-free compliant device (such as car navigation, etc.), you can operate the device to use functions such as voice call or videophone call.

For details on the operations of hands-free compliant devices, refer to their respective manuals.

- The ring tone and displays during an incoming call operate in accordance with the settings of the FOMA terminal.
- When a hands-free compliant device is connected to the FOMA terminal and is set to sound, even if the FOMA terminal is set to the manner mode or the ring volume is set to “Silent”, the ring tone will sound from the compliant device while the FOMA terminal is receiving a voice call, a videophone call or mail.
- While the driving mode is set, the “Arrival call act” will operate in accordance with the settings for “Driving mode”(p.82).
- While the record message is set, the “Arrival call act” will operate in accordance with the settings for “Record message”(p.84).
- When making a videophone call by using phonebook or redial with the hands-free compliant device, the communication speed will be varied depending on the settings of the hands-free device. If no settings are made, the communication speed automatically turns to 64K.
- When connecting the hands-free device to the FOMA terminal which is set to emit sounds, if you fold the FOMA terminal during a call, it will operate in accordance with “Fold setting”(p.160). If you set the hands-free device to emit sounds, even after the FOMA terminal is folded, the conditions for the call remain unchanged in spite of the settings of “Fold setting”.

* This function is an optional function which will be available at the time when the hands-free compliant devices are finally released. As of., Mar. 2004, no compliant devices have not been released yet.

Putting Calls on Hold When You Cannot Answer Immediately

When you cannot answer a call immediately during an incoming call, you can put the call on hold to keep the other party for a moment.

- The caller is charged for the time that the call is put on hold.

1 Press when a call comes in.

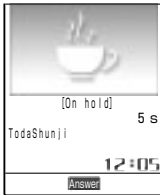

Voice call

3 short tones “pip-pip-pip” sound and the call is put on hold.

The FOMA terminal plays an announcement in Japanese informing the caller that you are unable to answer the call now, asking the caller either to hold on for a moment or to call back a little later, while the call is on hold.

To terminate a call while the call is on hold

Press .

If the caller hangs up while the call is on hold

The call ends.

2 When you are ready to answer the call, press or [Answer].

If you set “Answer setting” (p.159) to “Any key answer”, you can answer the call by pressing

either  ~ , , , , ,  or .

NOTE

- You can set an announcement the other party hears while the call is on hold in the “Select hold tone”.
→p.158
- If you receive a call during 64K data communication, you cannot put it on hold.
- When “Ring volume” (p.79) for the “Phone/Video-phone” is set to “Silent”, or the Manner mode is set to ON (p.135), no 3 short tones “pip-pip-pip” sounds. However, if the manner mode operation is set to “Original” and other than “Silent” is set to “Level”, the FOMA terminal sounds.

When You are Driving and Cannot Take Calls

Driving mode (In-car answering function) is an automatic answering service that helps to ensure your safety while driving. When you set the FOMA terminal to the driving mode, the caller hears an announcement saying that you cannot answer the voice/videophone call because you are driving, and the call is ended.

- You can set or cancel the driving mode only while the standby display is displayed. Even when “” is displayed, you can set or cancel the driving mode.
- You can still make calls as usual when the FOMA terminal is in the driving mode.

Setting the driving mode

- 1 Hold down  for 1 second or more while the standby display is displayed.

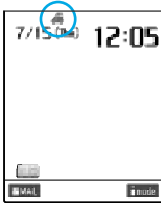

The message indicating that the driving mode is set is displayed and “” appears on the standby display.

To cancel the driving mode

With the driving mode set, hold down  for 1 second or more while the standby display is displayed.



The message indicating that the driving mode is displayed and “” disappears.

NOTE

- If you set the “Record message” (p.84) to “ON”, the announcement of the driving mode is given priority so that the “Record message” function is temporarily disabled.
- If you make an emergency call (110, 119 and 118) during the driving mode, the message notifying of the cancellation of the driving mode is displayed, and then the driving mode is canceled.
- The following do not sound during the driving mode.
 - Ring tone for voice call or videophone call
 - Ring tone for mail
 - Ring tone for Msg. Request or Msg. Free
 - Alarm sound for Alarm clock
 - Alarm sound for Schedule
 - Alarm sound for ToDo
 - Alarm sound when the battery runs out
 - Charge sound
 - i-appli software ring

When the driving mode is set

Your FOMA terminal does not sound even when receiving a voice or videophone call. Instead, the call is recorded as a missed call record in the “Received calls” (p.151) and the “Missed call” desktop icon appears on the standby display.

The FOMA terminal does not sound when receiving mail or 64K data communication as well. Voice callers hear an announcement saying that you cannot answer the call because you are driving, and the call ends. For videophone callers, the message is displayed notifying the caller that you cannot answer the call because you are driving, and the call is ended. However, when the power is off or “” appears on the screen, the caller receives no announcement/message about driving but hears the same announcement when “” is displayed.

When the network services are set and the driving mode is activated

When you receive an incoming voice/videophone call in your FOMA that sets both driving mode and the network service, the terminal operates as follows:

Service	When receiving voice calls	When receiving videophone calls
Voice mail	A message is taken after playing the guidance telling the other party that you are driving. ^{※1}	You cannot use the voice mail service with the videophone call. The call is terminated after displaying to the other party a message saying that you are driving.
Call forwarding	The call is transferred to the forwarding destination after playing the guidance telling the other party that you are driving. ^{※2}	You can use the call forwarding service with the videophone call. The call forwarding service is given priority and an incoming videophone call is immediately forwarded to the forwarding destination. ^{※3}
Bar nuisance call	<ul style="list-style-type: none"> For the telephone number registered in Reject Nuisance Calls, the call is terminated after playing the guidance telling the other party that the incoming call is rejected. For any other telephone numbers, the call is terminated after playing the guidance telling the other party that you are driving. 	<ul style="list-style-type: none"> You can use the bar nuisance call service with the video phone call. For the telephone number stored in Reject Nuisance Calls, the bar nuisance call service is given priority and the call is terminated without playing the guidance telling the other party that the incoming call is rejected. For any other telephone numbers, the call is terminated after playing the guidance to the other party that you are driving.
Caller ID request	<ul style="list-style-type: none"> If the other party does not notify you of his/her telephone number, the call is terminated after playing the guidance asking the other party to notify you of his/her telephone number. If the other party notifies you of his/her telephone number, the call is terminated after telling the other party that you are driving. 	You cannot use the caller ID request service with the videophone call. The call is terminated after displaying to the other party a message saying that you are driving.

※1 : When the ringing time of the voice mail service is set to 0 second, no driving mode announcement is played.

※2 : When the ringing time of the call forwarding service is set to 0 second, no driving mode announcement is played.

※3 : The videophone call cannot be transferred unless the forwarding setting is compatible with 3G-324M (p.87).

Having the Caller Leave a Message

Default setting | Record message: OFF | Answer message: Japanese 1 | Ringing time: 8 seconds

When you are unable to answer voice or videophone calls, you can set the FOMA terminal to record a message from the caller.

- You can set an answer message to be played before a caller leaves a message.
- You can record up to 5 voice messages, each lasting about 20 seconds.
- You can start the record message by using “Quick record message” (p.136) even if the record message is not set.

Setting the record message

1 Select   “Record message”.

2 Select the item you want to set.



To set “Record message”

- Select “ON”
- Go to Step 3.

Not to set “Record message”

- Select “OFF”

3 Select an answer message.



- Japanese 1 : The message “I cannot answer your call right now. Please leave your name and message within 20 seconds after the beep. Even for a videophone call, only voice message can be received.” is played in Japanese.
- Japanese 2 : The message “Thank you for your call, but I can’t take your call right now. Leave me a message after the beep. Only voice message even for a videophone call. Sorry.” is played in Japanese.
- English : The message “I can’t take your call now. Please leave a message. When you call by videophone, you can leave a voice message.” is played.
- Voice announce 1, 2 : The voice you recorded in the “Voice announce” (p.249) is played.
If no announcements are recorded, these are not displayed.
- Highlight Answer message and press  [Play], then the message comes out from the speaker.

4

Enter the ringing time (000 to 120 seconds).

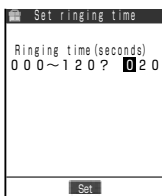

Enter the duration by 3 digits. If you enter a number other than 000-120, a message appears notifying you that the number cannot be specified. Once you enter 3-digit duration, the record message is automatically specified and “” is displayed on the standby display.

To set the display time

Press  [Set] without entering time.

NOTE

- The ringing time of the record message cannot be set to the same time as that of the “Remote monitor” or “Automatic answer”.
- To give a higher priority to the record message function over the “Voice mail” service (p.273) or “Call forwarding” service (p.278) when the service is activated together with this function, set the shorter ringing time for the record message than that for the voice mail service or call forwarding service.
- You can set different answer messages for a specific phone number or group in the “Utilities”.

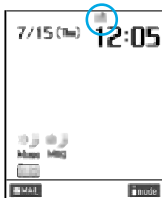

When a call comes in while the record message is set to “ON”



After the specified time passed, the record message function is activated and the caller hears the set answer message. When receiving a videophone call, the caller also receives the “伝言×毛/Record Msg. <音声録音中/Voice Only>” message image.

When a record message starts being recorded, the Recording in screen is displayed. You can hear the other party's voice from the earpiece speaker of the FOMA terminal during the recording.





To answer a voice call

Press  or  [Answer]

To answer a videophone call



If you answer the call with the camera view mode, press , while with a substitute image, press  or  [Answer].

When recording ends, the screen returns to the standby display with the “Missed call” and “Record message” desktop icons.

The “” icon changes to “” when there is 1 recorded message, to “” when 2 recorded messages, and to “” when 3 recorded messages.

Playing/Deleting Record Messages and Voice Memos →p.247

NOTE

- You cannot use Record message when “” is display.
- When receiving a videophone call, only a voice message is recorded.
- During “PIM lock”, even if the record message is set to “ON”, this setting is changed to “OFF”. In this period,  and no “Record message” desktop icon appears.
- Once there are 5 recorded messages on your FOMA terminal, the terminal can no longer record messages from callers and the callers hear no answer message. To record more messages, you must erase recorded messages. →p.248
- When Original Manner mode is set and “Record message” in the Original Manner mode is set to “ON”, a caller can record a message even if “Record message” is not set to “ON”. If there are already 5 messages, the FOMA terminal works according to the manner mode setting.
- When you activate the “Voice mail” service, new voice messages are stored in the voice mail service center even if 5 record messages are already recorded.
- You cannot receive an incoming call while the FOMA terminal is recording a message. The caller hears a busy tone.
- If the caller notifies the caller ID, it is displayed on your FOMA terminal display. If the caller’s name has already been stored in the phonebook, both the phone number and name appear.

Important

The contents of the messages may be lost if the FOMA terminal is damaged, repaired or otherwise handled in a way that causes such information in memory to be lost. It is the user’s responsibility to keep a separate record of all information recorded in voice messages. Under no circumstances shall NTT DoCoMo be held liable for any loss of or damage to the stored data in your FOMA terminal.

About a Videophone Call

You can use the videophone function with another DoCoMo videophone enabled terminal. You can also send substitute images such as still images and messages and Chara-den instead of your self-portrait.

- The videophone function can be enjoyed between the terminals which support the DoCoMo videophone function even if their models differ from each other.
- DoCoMo videophones conform to “3G-324M *1, the international standard established by the 3GPP**2”. You cannot connect with the videophone-support terminal that operates on a different system from the DoCoMo videophone.
 - ※1 : 3G-324M
An international standard for the third generation videophones.
 - ※2 : 3GPP (3rd Generation Partnership Project)
A regional standard organization established for the development of common technological specifications related to the third-generation mobile communication systems (IMT-2000).
- Communication speed of the videophone call is 64K/32K.
 - 64K: Communication speed of 64Kbps.
 - 32K: Communication speed of 32Kbps.

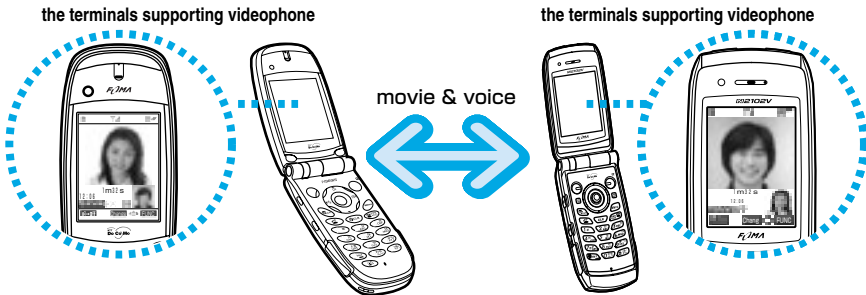

How to view displays during videophone calls

- ① Main display (displays the camera view of the other party by default).
- ② Sub display (displays the camera view of your own by default).
- ③ indicates call time
- ④ indicates current time
- ⑤ indicates the setting status for videophone calls

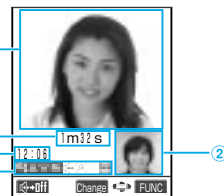

- | | |
|---|-----------------------------------|
| : 64K video calling | : Handsfree OFF |
| : 32K video calling | : Handsfree ON |
| : Voice transmitting | : Photo mode/Close-up |
| : Voice transmitting failure | : Photo mode/Scenery |
| : Video transmitting | : Photo mode/Portrait |
| : Video transmitting failure | : Key operation/DTMF mode** |
| : Camera image transmitting | ※:For details of DTMF, see p.340. |
| : Substitute image set in the “Select image” transmitting | : Key operation/Emot'n action |
| : Chara-den transmitting | : Key operation/Parts action |

Making a Videophone Call

If you make a videophone call, an in-camera image will be sent to the other party. You can also switch it to the out-camera to send the image by pressing  [Change]. You can set it to send other image (an alternative image, etc.) instead of the camera image as well. →p.98

- It is set to making a videophone call at the communication speed of “64K” when shipped. We recommend that you use the communication speed of “64K” to make a videophone call with another FOMA terminal.
- To visually communicate with the other party, use the earphone/microphone with a switch. Please see p.259 for the earphone/microphone with a switch.
- You can use DoCoMo’s international telephone service “WORLD CALL” to have an international videophone call. →p.73
- If the voice or video transmitting fails, the call does not recover automatically. Make a videophone call again.

<Example: Switching to Handsfree mode>

1 Dial the other party’s phone number, starting with the area code.



Even if you are within the same area code as the number you are dialing, you must enter the full number, including the area code.

[Area code]-[City code]-[Subscriber number]

To call a mobile phone

090-XXXX-XXX

or

080-XXXX-XXX

To call a PHS phone



070-XXXX-XXX

To make a call with a “32K” speed that supports the videophone function.

Select the “Dialing speed”-“32K” from the function menu.





2 Press and make a videophone call.



 flashes while a videophone is being dialed and lights during a call. If you make a call with the dialing speed “32K”,  flashes.

The digital communication charge is incurred when this screen is displayed.

3 After the videophone call is connected, press to switch to the handsfree mode.

“” appears and you can hear the voice of the other party over the speaker. When you press   again, the handsfree mode is turned off and “” changes to “”.

The voice of the other party can be heard around your FOMA. Choose the place where the sound does not bother other people to use the handsfree mode.

When sending the out-camera view



Press  [Change].

Pressing  [Change] switches between the in-camera and out-camera (Camera Switch).

To put a videophone call on hold

Press .

The other party can hear the hold tone and view the “保留Holding” image on the videophone display of one’s terminal.

To cancel putting on hold, press . To answer an on-hold videophone call with a camera view, press . To answer with a substitute image, press .

To use an earphone/microphone with switch (optional)

You do not have to switch to the handsfree mode. You can hear the voice of the other party over the earphone.

4 When you finish the conversation, press .

The call duration appears, and then the videophone call ends.

Videophone call functions

You can make various settings on videophone calls such as the size and quality of images you send.

- Handsfree* : Sounds the other party's voice from the speaker.
- Front camera/Rear camera* : Sends the image to the other party by switching between Front camera/Rear camera during a videophone call.
- Zoom* : Zooms in and sends your camera view to the other party. →p.96
- Camera/Other image : You can change the view of the displays during a videophone call. →p.97
- Image quality : Selects the image quality with emphasis on quality or motion. →p.97
- Brightness : Adjusts the brightness of your camera view. The setting operation is the same as that of the camera. →p.275 in 『Application』
- White balance : Adjusts your camera view to natural colors according to the light source. The setting operation is the same as that of the camera. →p.276 in 『Application』
- Color mode set* : Sends your camera view in sepia (dark brown) or black and white. The setting operation is the same as that of the camera. →p.276 in 『Application』
- Photo mode* : Sets the shooting mode according to the situations. The setting operation is the same as that of the camera. →p.275 in 『Application』
- Chara-den : Select the character displayed in Chara-den, display a list of actions and switch the action mode. →p.332 and p.333 in 『Application』
- Display light : Sets the display light for the display during a videophone call. →p.100
- Select image V-phone : Sets the image and its size to be displayed on the main screen. →p.100
- Call time display : Switches ON/OFF of the call time display shown on the screen during a videophone call.
- Send DTMF tone* : Sets/cancels the Send mode of the push signal during the Chara-den. The FOMA terminal always enters the Send mode of the push signal during a videophone call except Chara-den.
- Own number* : Displays your own phone number during a videophone call.
- * : "Handsfree", "Front camera/Rear camera", "Zoom", "Color mode set", "Photo mode", "Send DTMF tone" and "Own number" go back to the default values when you finish the videophone call.

When failing to make a videophone call

When a videophone call fails, the reason for the failure is displayed. However, depending on the situation, the reason for the failure may not appear. Depending on the type of the phone you are connected to or on your network service subscription status, the actual state of the other party and the displayed message may differ.

Message	Reason
Check the number and retry	You have dialed a wrong phone number.
Busy	The line is busy.
Out of service area or power off	The other party's phone is out of the service area or is turned off.
Driving mode	The other party's phone is in the driving mode.
Failed to connect	Reasons other than above.

NOTE

- You can make a videophone call with steps 1 and 2 reversed. In this case, if you call a wrong number, please press  to delete the display and then dial the correct number.
- When making a videophone call, you can use an entry in the phonebook, "Redial" or "Received calls" as well as a voice call.
- When you can make an emergency call (110, 119, and 118) on the videophone from the FOMA terminal, your call is automatically switched to a voice call. However, you cannot make these calls if you set "All lock".
- Connection is not made if you make a videophone call to a phone that does not support the videophone function, the other party's videophone is out of the service area or is turned off. If you make a videophone call to a phone that does not support the videophone function with the "Voice call auto switch" (p.95) set to "ON", your call is rejected before videophone connection is activated and is automatically redialed as a voice call. Note that this operation may not work when you make a wrong call such as a call to the access points for ISDN synchronous 64K or PIAFS, or a call to an ISDN videophone that does not support 3G-324M (p.87) (as of June, 2004). Be aware that you may be charged for a communication charge in this case.
- The "32K" communication speed is to make a videophone call with a device that cannot communicate using "64K" depending on the network conditions, such as PHS. If you make a videophone call in "64K" to a person in a different communication environment such as a "32K" area, it is automatically switched to "32K" and redialed. Please note that even if you make a videophone call in "32K", you will be charged the same digital communication fees as in "64K".
- If your videophone call cannot be connected in a communication speed of "64K" with the "Voice call auto switch" (p.95) set to "ON", it is automatically switched to a communication speed of "32K". If the videophone call cannot still be connected, it is switched to a voice call. When a videophone call fails, the automatic switch of communication speeds and the movements of "Voice call auto switch" are as follows:

	If the communication speed is "64K"	If the communication speed is "32K"
If the "Voice call auto switch" is "ON"	The communication speed is automatically switched to "32K". If the videophone call still cannot be connected, it is switched to a voice call.	The videophone call is switched to a voice call.
If the "Voice call auto switch" is "OFF"	The communication speed is automatically switched to "32K". If the videophone call still cannot be connected, the videophone call is hung up.	The videophone call is hung up.

- Once the videophone call is connected, it is not redialed as a voice call.
- You cannot make a voice call or connect to i-mode during a videophone call.
- When you receive a voice or videophone call during a videophone call, the call is recorded as a "Missed call" record in the "Received calls" (p.151) and the "Missed call" desktop icon appears on the standby display.
- i-mode mail and message request/free cannot be received during a videophone call and are once stored in the i-mode center. Receive these stored i-mode mail and message request/free by "i-mode checking" (p.106 and p.184 in [Application]) after the videophone call ends.
- You can receive SMS during a videophone call.
- When the Low-voltage alarm of "Recharge battery" appears during a videophone call, the other party sees a message saying "カメラオフ Camera Off" and the call is disconnected. Even if you start recharging the battery before the call is disconnected, the message still remains.
- When no image is sent due to the other party's setting, a substitute image is displayed.
- Even when a substitute image is displayed during a videophone call, the digital communication charge is charged.
- You cannot switch to the Handsfree operation while making a videophone call.
- Ending a videophone call turns the handsfree operation OFF.
- You can adjust the "Volume" (p.78) during the Handsfree operation.
- During the Handsfree operation, if you increase the "Volume" level, it may cause noise depending on your surrounding.
- If the background noise is loud during the Handsfree operation, you may not be able to talk in a good condition such as intermittent voice reception. In this case, use the earphone/microphone.
- The videophone call duration is calculated as the "Call time display". →p.161
- You can switch to the handsfree mode when the manner mode is set. You return to the manner mode when you select "OFF" in the handsfree mode or disconnect the call. The handsfree mode can be retained even if you set the manner mode when the handsfree mode is set.

Receiving a Videophone Call

Answering an incoming videophone call.



When you cannot answer a videophone call immediately, you can receive the call with a substitute image without allowing your own camera view to be displayed on the other party's screen.

- You cannot receive a videophone call during a voice call, i-mode operation, i-mode mail transmission and packet data communication.

1 When a videophone call comes in, press  to answer it.



To answer with a substitute image

Press  or  [Answer].

The substitute image is displayed on the other party's display.

Even after answering with the substitute image, you can switch to the camera view by pressing .

When using the earphone/microphone with switch (optional)

Press the switch of the earphone/microphone with switch.

You can answer the videophone call with a substitute image. When "Automatic answer" (p.262) is "ON", you can automatically answer a videophone call with a substitute image after the specified ringing time has elapsed.



To switch between the camera view and a substitute image

Press .

While the earphone/microphone with switch is connected, the same operation can be performed.

To put an incoming videophone call on hold

Press .

The image of "On hold" is displayed on the other party's video screen. Press  to answer the videophone call put on hold with a camera image, and  or  [Answer] to answer it with a substitute image.

To reject an incoming videophone call intentionally

Select "Call rejection" from the function menu.





To forward an incoming videophone call

Select "Call forwarding" from the function menu.

A subscription to the "Call forwarding service" (p.278) is required. The call will be connected to the forwarding number whether the "Call forwarding" service is "Activate"/"Deactivate".

2 After the videophone call is connected, press to switch to the handsfree mode.

"" appears and you can hear the voice of the other party over the speaker. When you press

  again, the handsfree mode is turned off and "" changes to "".

The voice of the other party can be heard around your FOMA. Choose the place where the sound does not bother other people to use the handsfree mode.

To send the out-camera view



Press  [Change].

Pressing  [Change] switches between the in-camera and out-camera (Camera Switch).

To put a videophone call on hold

Press .

The other party can hear the hold tone and view the "保留 Holding" image on the videophone display of one's terminal. To cancel putting on hold, press .

To answer an on-hold videophone call with a camera view, press . To answer with a substitute image, press .



When using an earphone/microphone with switch (optional)

You do not have to switch to the Handsfree mode. You can hear the voice of the other party over the earphone.

3 When you finish the conversation, press .

The call duration appears, and then the videophone call ends.

NOTE

- You cannot take a videophone call by the "Any key answer" function even when the "Answer setting" (p.159) is set to "Any key answer". (If "Answer setting" is set to "Quick silent", pressing any key stops the ring tone only.)
- Even while a substitute image is displayed during a videophone call, the digital communication charge is charged to the videophone caller.
- You can change a substitute image in the "Select image" (p.98).
- Even if the "Voice mail" service is "Activate", an incoming videophone call cannot be connected to the voice mail service center. An incoming videophone call is continued.
- Even if "Call forwarding" service is "Activate", an incoming videophone call cannot be forwarded unless the destination is a videophone-support device that conforms to 3G-324 (p.87). Make sure the forwarding destination before making the forward setting. The videophone caller cannot view the guidance for forwarding calls.
- When no image is sent to your FOMA terminal due to the other party's setting, a substitute image is displayed.
- You cannot switch to the handsfree operation while receiving a videophone call.
- Ending a videophone call turns the handsfree operation OFF.
- You can adjust the "Volume" (p.78) during the Handsfree operation.
- When the earphone/microphone with switch is connected, you can answer a videophone call with the camera view by pressing  or with a substitute image by pressing  as same as the case with no earphone connected.

Enjoying a Chara-den

When you make a videophone call, send a substitutive animated image instead of your image.

You can put expression on a Chara-den substitutive animated image by moving its mouth in reaction to sound or moving its limbs with key operation.

- Please set up the following functions in advance in order to enjoy Chara-den:
 - Set the “Camera off” to “Chara-den”. →p.98
 - Set the “My image sending” to “OFF”. →p.98
- When you receive a videophone call, press to answer it in Chara-den.
- To switch from Camera image to Chara-den, press .
- For details of Chara-den such as switching to Chara-den or checking its action, refer to p.332 and p.333 in 『Application』.

1 Press the dial key to operate Chara-den

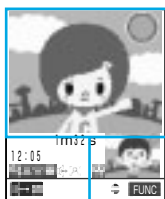

Chara-den

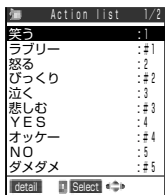

Action list

Pressing the dial key expresses the action assigned to that particular button.

To switch the Action mode

Select “Chara-den”-“Change action” from the function menu.

Every time when you select “Change action”, you can switch the “whole action” and “parts action”.

The “whole action” is an action mode to express movements of the whole Chara-den such as feelings. Press ~ or ~ to express them.

The “parts action” is an action mode to express partial movements of Chara-den such as a face and arms and legs. Press ~ to express them.

To confirm the action

Select “Chara-den”-“Action list” from the function menu.

The actions that can be operated and the buttons assigned to those actions are displayed.

You can select an action using to execute it.

Press to display the list of actions.

To switch to another Chara-den

Select “Chara-den”-“Switch Chara-den” from the function menu.

NOTE

- If “Send DTMF tone” is selected from the function menu, pressing a key sends the pulse signal so that you cannot move Chara-den with key operation. Selecting “DTMF tone OFF” from the function menu enables to move Chara-den with key operation.
About DTMF →p.340

Settings for Making a Videophone Call

You can set for redialing a failed videophone call as a voice call and set the communication speed for making a videophone call.

Automatically redialing a failed videophone call as a voice call <Voice call auto switch>

Default setting OFF

You can redial automatically as a voice call if the recipient cannot receive the videophone call when the recipient has the non-videophone call terminal, or uses the mova terminal in “Dual Network Service” (p.287).

1

Select   “Video-phone”  “Voice call auto switch”.

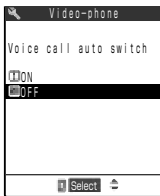

To redial automatically as a voice call

Select “ON”.

To not redial automatically as a voice call

Select “OFF”.

NOTE

- When redialing a failed videophone call as a voice call, you are charged for a voice call charge.
- When redialing the same number more than once, that number is recorded as one record and the most recent call in the “Dialed calls”.
- Once a videophone call is connected, redialing to the same phone number as a voice call is not performed.
- The redial may not be implemented even when “Voice call auto switch” is set to “ON” depending on the network or recipient’s status, for example, when the recipient is in out of service area, or is on another line.

Setting the communication speed for making a videophone call

You can set the communication speed for each videophone call you make.

- The connection at the communication speed of “64K” is recommended for videophone calls between FOMA terminals.
- After hang up the videophone call, the setting of the communication speed automatically returns to “64K”.

1

Display a phone number on the screen, and then select “Dialing speed” from the function menu .

When you display the phone number from the phonebook, select “utilities” from the function menu, and then select “Dialog speed”.

2 Select the connection speed.



- 64K : Set to make a videophone call with the "64K" communication speed.
- 32K : Set to make a videophone call with the "32K" communication speed.

To cancel the set connection speed
Select "Release".

3 Press to make a videophone call.

You can make the call at your favorite communication speed.

NOTE

- Digital communication charge is fixed for any communication speed.
- You can set the communication speed for each phone number or group in the phonebook. →p.120

Setting the Image to be Sent to the Other Party

You can set the image to be sent to the other party during a videophone call.

Zooming in the image to be sent

You can enlarge and send your camera view to the other party during a videophone call.

- The maximum magnification is about 2 times (2 steps) for sending the in-camera view and about 4.2 times (16 steps) for sending the out-camera view.
- If you switch the in-camera and out-camera during a videophone call, each zoom ratio remains. When you exit the videophone call, the zoom returns to the normal.
- When sending a substitute image, you cannot zoom in the image during a videophone call.
- You cannot zoom in the other party's camera view.

1 Press during a videophone call to display the zoom bar.

2 Adjust the zoom ratio.



To zoom in
Press .

To zoom out
Press .

Switching camera images on the other party's and your own sides

Default setting	Main screen : The other party's camera image
	Sub screen : The camera image on your own side

You can switch the main screen to the camera image on your own side and the sub screen to that on the other party's side during a videophone call. It will be convenient to use this function if you want to check the image being sent to the other party on the main screen, etc.

- 1 Select "Camera image/Other image" from the function menu during a videophone call.



Every time you select "Camera image/Other image", the images on the main and sub screens switch.

Setting the image quality for transmitting images

Default setting	Normal
-----------------	--------

You can select the image quality for images transmitted from/to the other party with emphasis on image quality or motion.

- Even though a videophone call is finished, the settings of this function are kept.

- 1 Select   "Video-phone"  "Image quality".

- 2 Select the image quality for transmitting images.

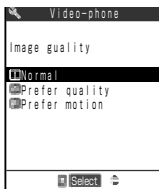

Normal : Displays image quality and motion at standard settings.
 Prefer quality: Transmits images with fine quality (in frame-by-frame motion). Effective when significantly motionless.
 Prefer motion: Transmits images in smooth motion (with rough image quality). Effective when significantly active.

NOTE

- You can also set the image quality during a videophone call by selecting "V-phone settings"- "Image quality" from the function menu. However, after the videophone call ends, this temporary setting returns to the default setting.

Setting whether to send a camera view image while making a call

Default setting **ON**

You can select the image to be sent to the other party from between the camera view and a substitute image when making a videophone call.

- Even though a videophone call is finished, the settings of this function are kept.

1 Select   “Video-phone”  “My image sending”.



To send the camera view
Select “ON”.

To send a substitute image
Select “OFF”.

NOTE

- Regardless of the setting of this function, you can switch between the camera view and a substitute image during a videophone call.
- You can change a substitute image to be sent in the “Select image” settings.

Setting the image to send during a videophone call

Default setting **On hold, Holding, Record message: Pre-installed Camera off : Chara-den**

You can set a image to send instead of your camera view.

- The image that can be set for this function is a JPEG file with the VGA size (640×480 dots) or less. Please note that if you set up an image exceeding the Mail (Large) size (176×144 dots), it is reduced to the Mail (Large) size (176×144 dots).
- Even though a videophone call is finished, the settings of this function are kept.

<Example: Setting a substitute image>

1 Select   “Video-phone”  “Select image”.

2 Select “Camera off”.



Set a substitute image to send instead of your camera view during a videophone call.

To set an image to send while a call is on hold

Select “On hold”.

To set an image to send while a call is holding

Select “Holding”.

To set an image to send while an answer message for record messages is playing

Select “Record message”.

3 Select an image to send.



To send a message only

Select “Pre-installed”.

To send a message with an image

Select “Original” and then select the image to send.

How to set an image →p.309 in 『Application』

To send Chara-den

Select “Chara-den”.

The Cara-den set in the “Substitute image” for Chara-den player is sent.

About Chara-den player →p.332 in 『Application』

To check the set image

Highlight the item you want to check, and then press  [Play].

Messages to be sent

Messages to be sent are as follows:

While a call is on hold	: “応答保留中 On Hold”
While a call holding	: “保留 Holding”
When a substitute image is sent	: “カメラオフ Camera Off”
While an answer message is operating	: “伝言メモ/Record Msg. <音声録音中/Voice Only>”

NOTE

- When an image of the Mail (Large) size or larger is reduced, the aspect ratio may be changed.
- The image is reduced only on the display with no influence on the original image data.
- You can set an image to send by selecting “Select image” from the function menu in the details screens of the dial input screen, phonebook, redial, and dialed/received calls. You can also set it by selecting “Select image” in the Phone to function (p.113 in 『Application』). However, when the videophone call ends, this temporary setting return to the original setting.
- Even if a substitute image is set to “Chara-den”, while shooting in the continuous mode or displaying the check mode screen, the Chara-den is not sent but the “Pre-installed” image is sent.

Setting the Image to be Displayed During a Videophone Call

You can set the image to be displayed during a videophone call and the display light.

Setting the image and its size to be displayed on the main screen <Select image V-phone>

Default setting | Main display: Other image | Change display size : Main display size

- Even though a videophone call is finished, the settings of this function are kept. In addition, if you change the settings of this function during the videophone call, the changed settings are reflected.

1 Select   “Video-phone”  “Select image V-phone”.

2 Select the item you want to set.



To switch the camera view between main and sub screens

Select “Main display”.

Select the main screen image from the other party’s image (Other image) or your own image (Camera image).

To set the image display size

Select “Change display size”.

Select the image display size from “Main display size/Real size”.

NOTE

- You can also make the above settings during a videophone call by selecting “Change display size” from the function menu. In that case, the original setting is also changed.
- If the display is not in motion smoothly during the videophone call, “Real size” is recommended to set “Change display size”.

Setting the display light during a videophone call

Default setting | All time ON

- Even though a videophone call is finished, the settings of this function are kept.

1 Select “Display light” from the function menu during a videophone call.



2 Select the item you want to set.



To turn the display light on all the time during a videophone call
Select "All time ON".

To turn the display light on for 15 seconds during a videophone call

Select "15 seconds ON".

NOTE

- The setting of this function is given priority over that in the "Display light" (p.183) for the "Display" during a videophone call.

Setting the Remote Monitor

Default setting | Other ID: Not stored | Ringing time: 5 seconds | Set: OFF

Through the camera view of your FOMA terminal, you can check the behavior of your pet in your home from outside. You can also check local conditions such as a plant or operation status from a remote location.



Remote monitoring can be activated between a videophone-support terminal conforming to 3G-324M (p.87) and a FOMA terminal, or between FOMA terminals. Your FOMA terminal can work as a terminal for both sending and receiving remote monitor data.

- You can carry out remote monitoring only if the recipient of the remote monitor has the telephone number of the person who monitors registered in advance and the remote monitor setting is "ON".

Preparing the called side terminal

At the receiving terminal of remote monitoring (the called side), perform the remote monitor settings such as the calling side's phone number (Other ID) and the time until remote monitor operation starts (Ringing time).

- Up to 5 phone numbers can be stored for the Other ID.
- If the "Manner mode" or "Driving mode" is set to the called side, remote monitor data cannot be received.

1 Select   "Video-phone"  "Remote monitor", and then enter the security code.

Security code → p.192

2 Select "Other ID".

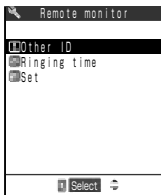

3 Select the item <Not stored>.

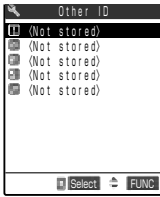

To change previously stored other ID

Select the other ID to be changed.

To enter from the “Phonebook”, “Dialled calls” or “Received calls”
Select “Look-up address” from the function menu, then select the item.

To delete one Other ID

Highlight the one you want to delete and select “Delete this” from the function menu.

To delete all the Other IDs

Select “Delete all”.

4 Enter the Other ID.

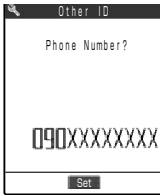

If you enter, the list of the Other ID reappears. Press  to return to the remote monitor screen.

5 Select “Ringing time” and enter the ringing time (003 to 120 seconds).

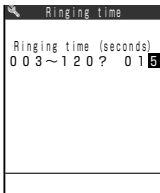



Enter the time in 3 digits. After entering a 3-digit time, the ringing time is set.

To set the displayed time

Press  [Set] without entering a number.

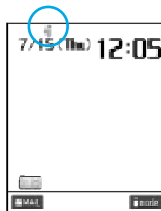
6 Select “Set” on the Remote monitor screen, and select “ON”.



The remote monitor is set and the “” appears on the standby display.

To receive no remote monitoring
Select “OFF”.

7 Set up the FOMA terminal.

In remote monitoring, the in-camera view is transmitted to the calling side. Therefore, set up the FOMA terminal of the called side with the power on and opened. If set with folded, the remote monitoring incoming call is disabled and the call is rejected.

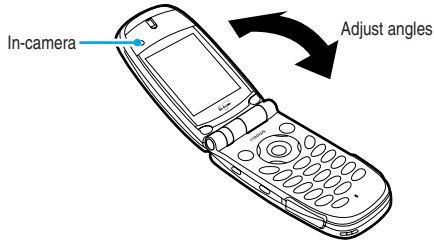

NOTE

- The ringing time cannot be set to the same time as that for the “Record message” or “Automatic answer”.
- If the ringing time for the “Call forwarding” service set at the called side is shorter than that set for remote monitoring, “Call forwarding” is given priority. To give a higher priority to remote monitoring, set the shorter ringing time than that set for the “Call forwarding” service.
- If you delete all Other IDs after setting the remote monitoring to “ON”, the setting is still active and “” still remains on the screen. In this case, however, you cannot perform the remote monitoring.

Performing remote monitor

Make a videophone call to the called side FOMA terminal to check the camera view of the called side.

- To perform remote monitoring, you must make a videophone call from the FOMA terminal that is stored at the called side terminal as Other ID with caller ID informed.
- At the called side, no camera view of the calling side appears and no voice sounds.
- You cannot switch the image to be sent to a substitute image on the called side FOMA terminal during remote monitoring.
- When the called side terminal is set to the “Manner mode” or “Driving mode”, no remote monitoring is performed.

1 Make a videophone call to the called side.

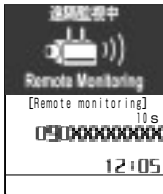

Screen of the called side

After the ringing time set at the called side has elapsed, the remote monitor starts.

The camera view of the called side is displayed at the calling side and voice sounds.

If you switch to the Handsfree mode by pressing , you can hear the called side's voice from the speaker. When the earphone/microphone with switch (optional) is connected, you can hear the called side's voice from the earphone without switching to the Handsfree mode.

To answer a videophone call at the called side without receiving remote monitoring

Press to display your camera view or to display a substitute image before the ringing time is over.

NOTE

- You can receive an incoming call from the number stored in the Remote Monitor while All lock is set.
- When the caller ID is not notified, the remote monitor does not start and the incoming call is treated as a usual videophone call.
- When “Call acceptance” is set at the called side for a phone number other than Other ID, or “Call rejection” is set for a phone number of Other ID, incoming videophone calls are rejected and the remote monitor cannot be performed.
- You cannot perform the remote monitor when you set the remote monitor and the following functions at the same time:
 - Driving mode
 - Manner mode
 - Call rejection/acceptation
 - Reject unknown
- When you set the Remote monitor and Record message at the same time, the Remote monitor is given priority even if the ringing time of Record message is set shorter than that of the remote monitor setting.
- When the earphone/microphone with switch (optional) is connected, the ring tone sounds through both the earphone and speaker regardless of the “Earphone” setting.
- The FOMA terminal emits the ring tone exclusively for the remote monitor and you cannot change it.
- The ring tone for the remote monitor sounds at the level set in the “Ring volume”. If you set it to “Silent”, “Level 1” or “Step”, the ring tone sounds at the “Level 2”.
- The flashing color and pattern become “Gradation” and “Standard” respectively regardless of the “Illumination” setting when a remote monitoring incoming call comes.
- You cannot put a call on hold while a remote monitoring incoming call comes. Press  to end the remote monitor.
- When the remote monitor setting is “ON” at the called side, an incoming videophone call from a phone number stored as Other ID is recorded as a received call record of the remote monitor. If the remote monitor is not performed, the call is recorded in the “Received calls” (p.151) as a missed call record of the remote monitor.
- Folding the FOMA terminal of the called side during remote monitoring causes the following behavior according to the setting in “Fold setting”.
 - Hold : The holding image is sent to the calling side.
 - No tone : The substitute image is sent to the calling side.
 - End the call: Remote monitoring is terminated.
 However, when the earphone/microphone with switch is connected, a substitute image is displayed regardless of the setting in “Fold setting”.
- During remote monitoring, both the calling and called sides cannot receive a voice or videophone call. If you receive a voice or videophone call during remote monitoring, the call is recorded as a missed call record in the “Received calls” and the “Missed calls” desktop icon appears on the standby display.
- During remote monitoring, Message Request/Free and i-mode mail are not received at the calling and called sides, and are stored in the i-mode center instead. After remote monitoring ends, receive these message by “Check new message” (p.106 and p.184 in 『Application』). However, you can receive SMS during remote monitoring.
- You can keep the FOMA terminal stable for remote monitoring by placing a tripod on the desktop holder.

Ending remote monitor

1

Press .

The call duration appears, and then the remote monitor ends.
Pressing  at the called side also ends the remote monitor.



Please be considerate of the privacy of individuals around you when taking and sending pictures using camera-equipped mobile phones. If you are seriously inconvenient to others when using the FOMA terminal, you may be liable to prosecution under respective laws or bylaws (such as Public Nuisance Laws).







Phonebook Available with the FOMA Terminal

The FOMA terminal provides the following two types of phonebooks: the FOMA terminal (main unit) phonebook to which various functions can be set and the FOMA card phonebook that can be used in any FOMA terminal. Use these phonebooks properly according to your applications.

Differences between the FOMA terminal (main unit) and FOMA card phonebooks

Stored entries

The stored entries to the phonebook in the FOMA terminal (main unit) and FOMA card are shown as follows:

Stored entries	FOMA terminal (main unit) phonebook	FOMA card phonebook
Maximum number of phonebook entries**1	Maximum 700	50
Storing name	By family name and first name separately	By full name
Maximum number of groups**2	00-19	00-10
Storing phone number**3	Up to 4 phone numbers can be stored per phonebook entry, and up to 700 phone numbers in the phonebook. You can store a person's mobile phone number and office phone number, etc. as a single phonebook entry.	One phone number can be stored per phonebook entry.
	You can select and store an icon from 24 icons such as “  ” and “  ” for phone numbers, so that categories such as “mobile phone number” and “office phone number” can be seen at a glance.	These icons cannot be selected. “  ” is automatically stored.
Storing mail address	Up to 3 mail addresses can be stored per phonebook entry, and up to 700 mail addresses in the phonebook. You can store a person's home mail address and office mail address, etc. as a single phonebook entry.	One mail address can be stored per phonebook entry.
	You can also select and store an icon from 5 icons such as “  ” and “  ” for mail addresses, so that categories such as “home mail address” and “office mail address” can be seen at a glance.	These icons cannot be selected. The icon “  ” is automatically stored.
Storing image	One still image and one movie can be stored per phonebook entry. Up to 100 still images and 100 movies can be stored in the phonebook.	—
Storing other data	One postal code, address and memo can be stored per phonebook entry. They can be stored as a single phonebook entry together with phone number and mail address, etc.	—

※1 : The maximum number of the phonebook entries may be actually decreased depending on the stored content of each phonebook data.

※2 : You can change a group name of “Group 01” - “Group 19” (“Group 01” - “Group 10” in the FOMA card phonebook). Assigning your favorite group name before storing is useful. →p.128

※3 : You can enter 0-9, #, *, p in the phonebook. If you use a subaddress (p.150), enter *.

Characteristics of the phonebook of FOMA terminal (main unit)

If you register information into the phonebook of the FOMA terminal (terminal), you can use the following convenient functions:

- If you specify Memory Number “000” to “009”, you can use the “Two-touch dial” in which you can make a phone call by pressing 2 buttons. →p.110
- You can use “Utilities” and “Group utilities” in which you can set the incoming and outgoing call settings by telephone number, by mail address and by group. →p.120
- You can use “Restrictions” to put restrictions on outgoing and incoming calls by telephone number. →p.141
- You can register a phonebook which you don’t want other people to know as secret data in the “Secret Mode” and “Secret only mode”. →p.201
- You can set the “Secret code”. →p.127

Characteristics of Phonebook of FOMA card

Since data on the phonebook is registered in the FOMA card, you can use the same phonebook in another FOMA terminal by inserting the FOMA card into it. It is convenient if you want to use multiple FOMA terminals for different purposes.

Name display

Voice/Videophone calls

When a call comes in with the caller ID informed and the caller’s name has already been stored in the phonebook, both the phone number and the name are displayed.



If a still image or movie is stored in the phonebook and the “Disp. phonebook image” (p.181) setting is “ON”, the still image or movie is also displayed.



The caller’s name is also displayed in the “Received calls”, “Dialled calls” and “Redial”.

i-mode mail/SMS

When an i-mode mail/SMS comes in and the sender's i-mode mail address/phone number has already been stored in the phonebook, the sender's name appears on the received mail list screen and details screens. If you send an i-mode mail/SMS to that party, his/her name also appears on the sent mail list screen and details screens.

In addition, the other party's name also appears on the "Received address" and "Sent address".

NOTE

- When a phonebook entry is stored in the "Secret mode" or "Secret only mode", only the caller/sender's phone number/mail address is displayed without the name.
- When "Restrict dialing" (p.141) is set, if the caller's phone number is not specified under the "Restrict dialing", only the phone number is displayed without the name.
- If the same phone number/mail address is stored in multiple phonebook entries with different names, the phonebook is searched by reading (p.116) and the name of the first displayed phonebook entry is displayed.

Storing an Entry in the Phonebook

- You must enter a "family name" or "first name". If no family name and no first name are entered, a phonebook entry cannot be stored in the phonebook.

Storing an entry in the FOMA terminal (main unit) phonebook

1 Select   "Add to phonebook".

2 Select "Phone".

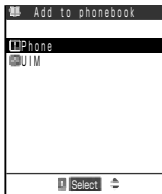

3 Enter the family name.

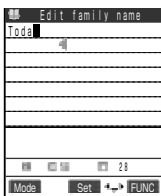

Enter the family name using kanji, hiragana, katakana, alphabets, numbers, symbols and pictographs.
Up to 16 full-pitch or 32 half-pitch characters can be entered for the full name.
You can enter only the first name without entering the family name.
Entering characters →p.300

4 Check the reading of the entered family name.

If the reading is incorrect

Enter the correct reading using half-pitch katakana, alphabets, numbers and symbols.
Up to 32 half-pitch characters can be entered for the full name.
The -reading search of the "Search phonebook" (p.116) searches entries by using the combination of the family and first names' readings entered in this step.

5 Enter the first name.

Enter the first name in the same manner as the family name.
You can enter only the family name without entering the first name.

6 Check the reading of the entered first name.

If the reading is incorrect, correct it in the same manner as the reading of the family name.

7

Set the respective items.



 Group

: Select the group to be stored from “00” to “19”. Group “00” is automatically stored if you do not select any group.



Telephone number

: Enter a telephone number and select the icon. You can enter up to 26 digits.

After registering the first telephone number, “ <Not stored>” is displayed on the edit screen of the phonebook. If you select this item, you can register a new telephone number.

If you want to register the telephone number of a general telephone machine, be sure to enter the telephone number, starting with the area code even if your telephone number has the same area code.



Mail address

: Enter a mail address and select the icon.

You can enter up to 50 characters including half-pitch alphabetical characters, numbers and symbols.

If you register the first mail address, “ <Not stored>” is displayed on the edit screen of the phonebook. You can select this item to register a new mail address.

How to enter characters →p.300



Address

: Enter a postal code and address. Enter 7 half-pitch numbers for the postal code. You can enter up to 46 full-pitch or 93 half-pitch characters including Kanji, Hiragana, Katakana, alphabetical characters and numbers for the address.



Memo

: Enter a memo. You can enter up to 50 full-pitch or 100 half-pitch characters including Kanji, Hiragana, Katakana, alphabetical characters and numbers.



Still image

: Select a still image to be displayed for incoming calls from data stored in the “Image viewer”.

How to select a still image →p.302 in [Application]



Movie

: Select a movie to be displayed for incoming calls from data stored in the “Movie player”.

How to select a movie →p.316 in [Application]







Memory no.

: Memory number is assigned when you store an entry in the phonebook. You can also change the memory number to your favorite number between 000-699.

8

Press  [Finish] to store a phonebook.

Two-touch dialing

If you assign phone numbers to the memory numbers “000” to “009”, you can dial quickly those phone numbers by simply pressing two keys: one of  to , and  or  [Dial] ( for a videophone call).

NOTE

- If you enter “フ (full-pitch lower case character)” for the first or family name, “フ (half-pitch upper case character)” is displayed for reading. If you enter symbols and pictographs, entered characters are not reflected to readings. Characters entered with Kuten code are changed to spaces. However, when characters entered with Kuten code are also listed in a half-pitch character (katakana or alphabet), they are reflected to readings.
- If you enter (edit) additional characters after entering first and last name, and pressing  [Set], those characters are not reflected on reading.
- The phonebook stored using symbols or pictographs may not be displayed properly when you perform memory forwarding etc.
- Enter correct mail address correctly including a domain name.
Domain name is to the right of the @ (at mark) in a mail address.
(Example) docomo.taro.△△@docomo.ne.jp
You cannot use the following functions if the whole mail address including the domain name is entered incorrectly:
 - Utilities and Group utilities →p.120
 - Displaying the mail sender's name →p.152 in 『Application』
 - Automatically sorting received mail →p.207 in 『Application』
 - Mail with photo →p.153 in 『Application』
- If a person's mail address is “phone number@docomo.ne.jp”, store only the phone number for the mail address.
- If original data of still images and movies registered in the phonebook are updated and/or deleted, the still images and movies in the phonebook are also updated and/or deleted.
- To display the stored still image or movie for an incoming call, set the “Display phonebook image” (p.181) to “ON”.
- When a stored still image or movie exceeds the image display area in the phonebook details screen, the image or movie is reduced with the same aspect ratio. If the still image or movie is smaller than the image display area, the display is centered.
- When a call comes in from a phone number stored in the phonebook with a still image or movie, if the image or movie exceeds the image display area set for “Calling” in the “Display setting” (p.177), the image or movie is reduced with the same aspect ratio. If the still image or movie is smaller than the image display area, the display is centered.
- It is recommended that you keep the data registered in the phonebook separately by taking notes or using a miniSD memory card (p.373 in 『Application』). You can also keep the data in your own PC by using the Data Link Software (p.472 in 『Application』) and the USB cable (optional).

Storing an entry in the FOMA card phonebook

- You must enter “name”. If no “name” entered, a phonebook entry cannot be stored in the phonebook.

1 Select   “Add to phonebook”.

2 Select “UIM”.

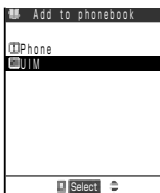

3 Enter a name.

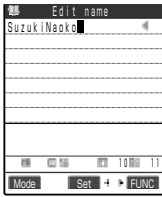

Enter a name by using kanji, hiragana, katakana, alphabets, numbers and symbols.
Up to 10 full-pitch characters or 21 half-pitch alphanumeric characters (including some half-pitch symbols) can be entered.
Entering characters →p.300

4 Check the readings of the entered name.

If the reading is incorrect

Enter the correct reading by using katakana (full-pitch only), alphabets, numbers and symbols.
Up to 12 full-pitch characters or 25 half-pitch alphanumeric characters (including some half-pitch symbols) can be entered.
The “-reading search” of the “Search phonebook” (p.116) searches entries by using the readings of the name stored in this step.

5 Set the respective items.

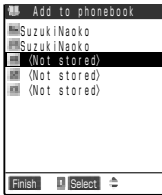

Group

: Select a group to be stored from “00” to “10”.
“00” is automatically used if you do not select any group.



Telephone number:

Enter a telephone number. You can enter up to 20 digits for the blue FOMA card and up to 26 digits for the green FOMA card.
To register the telephone number of a general telephone machine, be sure to enter the area code in front of the telephone number even if it has the same area code as yours.



Mail address

: Enter a mail address. You can enter up to 50 characters including half-pitch alphabetical characters, numbers and symbols.
Entering characters →p.300

6 Press [Finish] to store a phonebook.

NOTE

- If you enter “㇇ (full-pitch lower case character)” for the name, “㇈ (full-pitch upper case character)” is displayed for reading. However, you can enter “㇇ (full-pitch lower case character)” in reading input. If you enter symbols, entered characters are not reflected to readings. Characters entered by using Kuten code are changed to spaces. However, when characters entered with Kuten code are also listed in a half-pitch character (katakana or alphabet), they are reflected to readings.
- If you enter (edit) additional characters after entering first and last name, and pressing  [Set], those characters are not reflected on reading.
- The phonebook stored using symbols may not be displayed properly when you perform memory forwarding, etc.
- Enter a mail address including a domain name correctly. Domain name is a character string that follows @ (at mark).
(Example) docomo.taro.△△@docomo.ne.jp
You cannot use the following functions if the mail address including the domain name is not entered correctly:
 - Displaying the mail sender's name →p.152 in 『Application』
 - Automatically sorting received mail →p.207 in 『Application』
- If a person's mail address is “phone number@docomo.ne.jp”, store only the phone number for the mail address.

Storing data in the phonebook from received/sent call/mail record

You can store phone numbers directly to the phonebook from the “Received calls”, “Dialled calls”, “Redial”, “Received address” and “Sent address” or store a new phone number to the phonebook after dialing it.

- To add new phone numbers/mail addresses to an existing entry in the phonebook, call up the entry and then you can add new data to it.

<Example: Adding a new phone number to the FOMA terminal (main unit)
Phonebook from the “Received calls”>

- 1 Display the Received calls screen for the phone number you want to store.



How to display the received calls →p.151

- 2 Select “Add to phonebook”-“Phone” from the function menu.

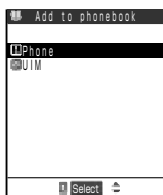

To store the phone number in the FOMA card
Select “UIM”.

3 Select “Add”, and search the phonebook entry where you will store the number.

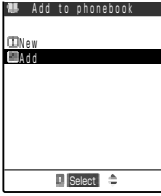

How to search a phonebook. →p.116

To store a phone number in a new phonebook entry
Select “New”.

When storing in the FOMA card
Select “New” or “Overwrite”.

4 Display the phonebook details screen, and then press [Select].



The phone number is automatically entered and the Edit phonebook Screen appears.

How to edit phonebook →p.119

5 When you finish editing, press [Finish].

When a message is displayed whether to overwrite or not
Select “YES”.

NOTE

- The caller ID setting (“Notify”/“Not notify”) displayed in the “Dialled calls” and “Redial” are not stored in the phonebook.
- Received addresses that cannot be used for return cannot be stored in the phonebook.

When phonebook editing is interrupted

When the “Alarm of battery exhaustion” rings or the tool group task is newly started by Multi task (p.267) during an edit of the phonebook, the editing of the phonebook is suspended. The phonebook that you are editing is automatically saved as temporary editing data. To restart the edit, call up the editing data.

1 Select   “Add to phonebook”.

2 Select “Phone” or “UIM”.

3 Select “Recall”.



You can resume editing the phonebook entry that was interrupted. If you resume editing the phonebook entry and stop editing without storing the editing data, the data will be erased.

To store a new phonebook entry

Select “New”.

NOTE

- Only the most recent data is saved as the data being edited.
- When you receive a voice or videophone call during phonebook editing, you can answer the call while keeping the phonebook data as it is.
During a voice call, press  to display the task menu, and then select the item being edited from the list screen to return to the phonebook edit screen. After ending a voice or videophone call, the phonebook edit screen reappears.

Important

- The first time you use the FOMA terminal after purchasing it, or if the FOMA terminal has been left for a month or more with no battery pack fitted or a run out battery pack fitted, you must recharge the internal backup battery. Charge the FOMA terminal with the battery pack fitted. This also charges the internal backup battery.
- We recommend you keep a separate record of data stored in the “Phonebook” in a notebook or the miniSD memory card (p.365 in 『Application』). If you have a PC, you can transfer the data stored in the “Phonebook” by using the data link software (p.472 in 『Application』) and a USB Connection Cable (Optional).
- The FOMA terminal (main unit) phonebook data will be retained for up to a month even if the battery pack is left removed from the terminal. However, the stored data may be lost if the FOMA terminal is left for longer periods with no power. The stored data may also be lost if the FOMA terminal is damaged, repaired, replaced, or otherwise handled in a way that causes such data to be lost.
- “The first phone number”, “Kana•Kanji full name”, “Group setting”, “The first mail address”, “Bookmark” and “Secret setting” can be copied to the new terminal at a DoCoMo service counter. Please note that it may not be possible to copy data which is stored in the FOMA terminal, depending on specifications of the new terminals.

Under no circumstances shall NTT DoCoMo be held liable for any loss of or damage to the stored data such as the phonebook data in your FOMA terminal.

In addition, you can forward the content of the phonebook to a PC and keep it by using data link software (p.472 in 『Application』).

Searching the Phonebook

You can call up a phonebook entry by using any one of 7 search methods: reading, name, phone number, mail address, memory number, group and column of reading (Japanese syllabary: order of a, ka, sa, ta and na).



- Phonebook entries stored as secret data are not displayed unless you set the FOMA terminal to the “Secret mode” or “Secret only mode”.
- You can make a call from the called up phonebook.

Search result display

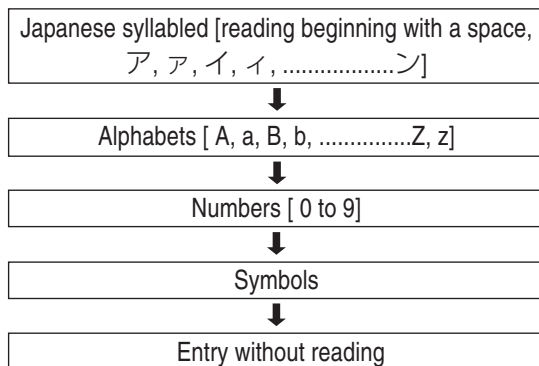
Except for memory number search, the phonebook entry is searched in the following order according to the reading entered when data is stored in the phonebook and the results are displayed.



1 Select “Search phonebook”.

You can display the phonebook search screen by pressing  to select “Search phonebook” or pressing .

2 Select the search method.



To display the search method with priority

Highlight the search method you want to display with priority, and then press  [Prefer].

“★” is attached to the search method with priority.

When you press  while the standby display is displayed at the next search, the set search method screen is displayed.

To cancel the search method with priority

Highlight the search method with “★”, and then press  [OFF].

3 Search the phonebook.

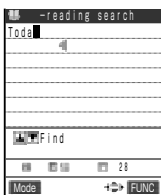

To search by reading

Enter part of the reading and then press or .

Enter the reading from the first in the order of the family and first name. You do not have to enter the entire reading you are searching for.

Entering characters →p.300

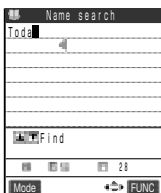

To search by name

Enter part of the name and then press or .

Enter the name from the first in the order of the family and first name. You do not have to enter the entire reading you are searching for.

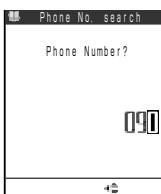

To search by phone number

Enter part of the phone number and then press or .

You only need to enter a first few digits or part of the phone number to search the entry.

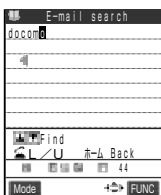

To search by mail address

Enter part of the mail address and then press or .

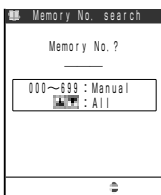

To search by memory number

Enter the 3-digit memory number.

The FOMA card phonebook cannot be searched by memory number.



To search by group

Select the desired group.

Groups of the phonebook of the FOMA card are different from those of the phonebook of FOMA terminal (main unit).

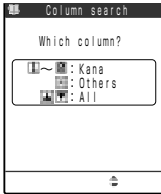

To search by column (in the order of Japanese syllabary)

Press the key corresponding to the column you want to search.

- : Displays only entries whose reading begins with the line of ア (A)
- : Displays only entries whose reading begins with the line of カ (Ka)
- : Displays only entries whose reading begins with the line of サ (Sa)
- : Displays only entries whose reading begins with the line of タ (Ta)
- : Displays only entries whose reading begins with the line of ナ (Na)
- : Displays only entries whose reading begins with the line of ハ (Ha)
- : Displays only entries whose reading begins with the line of マ (Ma)
- : Displays only entries whose reading begins with the line of ヤ (Ya)
- : Displays only entries whose reading begins with the line of ラ (Ra)
- : Displays only entries whose reading begins with the line of ワ (Wa), ヲ (Wo) or ッ (N)
- : Displays all other entries

When the search ends, a list of phonebooks that meet the searching conditions is displayed.

“” is displayed for the FOMA card phonebook entries on the search result list screen.

If no phonebook entry that satisfies the search conditions is stored, a message notifying you that there is no data is displayed.

To display a list of all phonebooks registered

Press or without entering any searching conditions.

Please note that you cannot display a list of all phonebooks if the searching method is “Group search”.

To make a call from List screen

Highlight the phonebook from which you want to make a call and press or .

A voice call will be made if you press , and a videophone call will be made if you press . If multiple telephone numbers are registered in the highlighted phonebook, the telephone number on the top of the list will be called.

4 Select the desired phonebook entry.



The detail screen of a phonebook is displayed.

If multiple telephone numbers are registered in the same phonebook

If you press , you can switch the telephone number displays.

To make a call from the detail screen of the phonebook

Display the telephone number to call and press or .

A voice call will be made if you press

, and a videophone call will if .

NOTE

- If you do not set the search method with priority, the phonebook search screen appears when you press , and the search method selected last will be highlighted.

Editing the Phonebook

Follow the procedure below to edit entries in the phonebook.
You can store an edited entry as a new phonebook entry.

- 1** Display the details screen for the phonebook entry you want to edit, and then press  [Edit].

How to search the phonebook →p.116

- 2** Edit the respective items.



Edit the items you need to change in the same operation as described for “Add to phonebook”.

How to add to phonebook →p.108

To store the edited entry under a new memory number.

Select “” to enter the memory number (000 to 699).

The original entry remains unchanged, and the edited entry is stored under a different memory number.

- 3** When you finish editing, press  [Finish], select “YES” and then press  [Select].

To store the edited entry in the FOMA card phonebook

Press  [Finish] and select “Overwrite”/“Add”.

If you select “Overwrite”, the existing entry is overwritten with the edited data.

If you select “Add”, the original entry remains unchanged, and the edited entry is stored as a new entry.

NOTE

- You cannot modify the phonebook when “PIM lock”, “Keypad dial lock” or “Restrict dialing” is set.
- You can only modify the phonebook of secret data in “Secret mode” or “Secret only mode”.

Distinguishing Incoming Calls for Each Phone Number and Group

Default setting | All canceled

You can set a different ring tone or answer message of the record message for each phone number, mail address or group in the phonebook. It is useful when distinguishing the caller of an incoming call by only a ring tone. You can set the following Utilities functions:

Purpose		Utilities	See page
Incoming	To distinguish the callers of incoming calls by a ring tone, image, etc.	By a ring tone* ¹	Ring tone p.163
		By the flashing color of the incoming call lamp* ¹	Illumination p.185
		By an image	Image p.177
	To set a different answer message for each phonebook entry when the record message is activated* ²		Answer message p.84
	To distinguish the senders of incoming mail by a ring tone, etc.	By a ring tone	Mail ring tone p.163
By the flashing color of the incoming call lamp		Mail illumination p.185	
Outgoing	To set a different communication speed for each phonebook entry when making a videophone call	Dialing speed p.95	

※1 : Incoming calls can be distinguished when received through 64K data communication.

※2 : You must set the “Record message” (p.84) to “ON” beforehand.

- You can set these functions for all phone numbers, mail addresses and all groups except “Group 00” stored in the FOMA terminal (main unit) phonebook.
- You cannot set these functions for the phonebook entries stored in the FOMA card.
- You cannot set these functions for the phonebook entries stored in the “Secret mode” or “Secret only mode”.
- When the caller restricts the phone number display, the Utilities are invalid. “Caller ID request” setting is useful. →p.286

Making incoming/outgoing setting for each phone number or mail address

You can follow the same procedure to set the incoming/outgoing utilities to phone numbers and mail addresses stored in the phonebook.

1 Display the details screen for the phonebook entry you want to set the Utilities functions.

How to search the phonebook →p.116

When multiple phone numbers are stored in a single phonebook

Press  to display the desired phone number.

2 Select “Utilities” from the function menu.

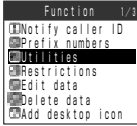

3 Select the item you want to set, and set its content.



“★” is attached to the function you have set.

To cancel the set function

Select the function with “★”.

The function is canceled and “★” disappears.

When you set the Utilities functions

Icons to check the Utilities functions are displayed on a phonebook details screen.



- : Indicates that “Ring tone” is set.
- : Indicates that “Illumination” is set.
- : Indicates that “Image” is set.
- : Indicates that “Answer message” is set.
- : Indicates that “Mail ring tone” is set.
- : Indicates that “Mail illumination” is set.
- : Indicates that “Dialing speed” is set to “64K”.
- : Indicates that “Dialing speed” is set to “32K”.

NOTE

- Note that the Utilities functions are canceled if you change a phone number or mail address.
- To change the Utilities functions you have set, first cancel the current settings.

Making incoming/outgoing setting for each group

You can follow the same procedure to set the incoming/outgoing utilities to groups stored in the phonebook.

- 1 Select “Group setting”.

2 Highlight the group which you want to set, and select “Utilities” from the function menu.



3 Select the function you want to set, and set the contents of the respective function.



“★” mark is attached to the function you have set.

To cancel the set function

Select the function with “★”.

The function is canceled and “★” disappears.

NOTE

- If the same phone number or mail address has been stored in multiple groups, the priority is given to the settings specified for the group that contains the phone number or mail address found first in the line search order (p.116).
- You can set the Utilities functions for groups containing both phonebook entries (Secret data) stored in the “Secret mode” or “Secret only mode” and ordinary phonebook entries and groups containing secret data only. However, note that these functions are disabled for incoming calls from callers stored as secret data.
- To change the items you have set, first cancel the current settings.

Operational priority when settings are overlapped

When the Utilities settings are overlapped with other function settings, or multiple mail or message request/free with different settings are received, the FOMA terminal operates as follows:

Movements of incoming call lamp if incoming call settings overlap

The priorities are as follows. ① has the highest priority.

- ① Illumination settings of the Utilities
- ② Illumination settings of the Group Utilities
- ③ Illumination settings

Movement of ring tone if ring tone settings overlap

The priorities are as follows. ① has the highest priority.

- ① The ring tone of the Utilities
- ② The ring tone of the Group Utilities
- ③ Select ring tone

Incoming call display if incoming call settings overlap

The priorities are as follows. ① has the highest priority. However, if an i-motion operates as a ring tone, the i-motion will appear.

- ① i-motion of the phonebook registration image
- ② The Image of the Utilities
- ③ The image of the Group Utilities
- ④ The image of the phonebook registration image
- ⑤ Display settings

When communication speed settings are overlapped

The priorities are as follows. ① has the highest priority.

- ① The communication speed setting selected from the function menu when making a videophone call
- ② Utilities settings specified for each phone number
- ③ Utilities settings specified for each group

When receiving multiple mails or message requests/free simultaneously

	Ring tone/Illumination operations
Only multiple mail is received	Operate according to the conditions set for the last received mail.
Message requests and message free are received simultaneously	Operate according to the conditions set for message request.
Mail and message requests/free are received simultaneously	Operate according to the conditions set for the last received mail.

Checking the Utilities settings

You can check the phonebooks and groups that are set in “Utilities” by function. At the same time, you can also cancel each setting.

1 Select   “Utilities”.

2 Select the function with “★”.



The items of the function you selected are displayed.
“★” appears on the items that are set in Utilities.

To cancel the settings of the function at once

Highlight the function with “★”, and select “Release settings” from the function menu.

3 Select the item with “★”.

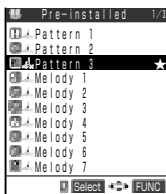

Ring tone

The list screen listing the names of phonebook entries and groups for which the selected settings have been specified appears.

“” is prefixed to the group names.

To cancel the settings of the function at once by item

Highlight the item with “★”, and select “Release settings” from the function menu.

4 Check the phonebook entries and groups for which the Utilities function is set.

To display a phonebook entry details screen

Select the phonebook entry you want to display.

To cancel the Utilities function set for a phonebook entry

Select the phone number and mail address you want to cancel on the details screen.

To cancel the Utilities function set for a group

Select the group you want to cancel.

Setting Up Phonebook Functions

Setting Notify/Not notify caller ID to a phonebook entry <Notify caller ID>

You can set whether to notify the other party of your caller ID or not every time you make a voice or videophone call.

- The setting of this function is not stored in the phonebook. You must make this setting for each voice or videophone call you make. If you omit this setting, the “Notify caller ID” service setting (p.285) applies.

1 Display the phonebook details screen you want to set.

How to search the phonebook →p.116

When multiple phone numbers are stored in a single phonebook

Press  to display the details screen for the phonebook entry for which you want to set.

2 Select “Notify caller ID” from the function menu.

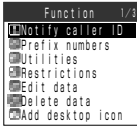

3 Select an item you want to set.



To not notify the other party of your caller ID

Select “OFF”.

“Not notify” appears.

When selecting a phone number prefixed with “186/184”, “186/184” is deleted.

To notify the other party of your caller ID

Select “ON”.

“Notify” appears.

When selecting a phone number prefixed with “186/184”, “186/184” is deleted.

To cancel the Notify caller ID

Select “Cancel prefix”.

When selecting a phone number prefixed with “186/184”, “186/184” is deleted and the “Notify caller ID” service setting (p.285) appears.

NOTE

- When you make a call with “Notify”/“Not notify” set, your phone number is stored in the “Dialled calls” and “Redial” with the same “Notify”/“Not notify” attached.
- When you dial a phone number or display it from the “Received calls”, “Dialled calls” or “Redial”, you can also set Notify caller ID in the same way.

Setting the FOMA terminal to display a phone number by just unfolding <Automatic display>

Default setting | OFF

You can set up the FOMA terminal to automatically display a specified phone number when you unfold it While the standby display is displayed. You can then call the displayed phone number by simply pressing . When you do not call the number, press , or to return to the standby screen.

- You can specify one phone number for the automatic display. No mail address can be specified.
- You cannot specify phone number for the phonebook entries stored in the FOMA card.
- You cannot specify phone number for the phonebook entries stored in the “Secret mode” or “Secret only mode”.
- The specified phone number is not displayed when you unfold the FOMA terminal while operating other functions or entering characters, or in the Secret only mode.
- You cannot select other phone numbers stored in the same phonebook entry during the automatic display.

Activating the automatic display

1 Select “Display” “Automatic display”.

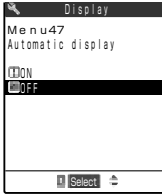

To display a specified phone number automatically
Select “ON”.

To display no phone number automatically
Select “OFF”.

Selecting a phone number to display automatically

1 Display the details screen for the phonebook entry for which you want to set this function.

How to search the phonebook →p.116

When multiple phone numbers are stored in a single phonebook

Press  to display the desired phone number.

2 Select “Automatic disp.” from the function menu.



“★” is attached to “Automatic display”.

To cancel the automatic display

Select “Automatic disp. ★” from the function menu.

The automatic display function is canceled, and “★” disappears.

NOTE

- In the following cases, the Utilities settings are invalid.
 - While PIM lock is set
 - While ALL lock is set
 - While Secret only mode is set
 - While Restrict dialing is set
 - During a talk

Setting a secret code in a mail address

To send i-mode mail to a recipient who has stored a secret code with his/her mail address (p.246 in 『Application』), you must add the secret code to the mail address. If you have set a secret code with the recipient's mail address, the code is automatically added when you send a mail to that address.

- You can also set a secret code for a phone number to send i-mode mail to an i-mode terminal only by referring to its phone number.
- Secret codes are added to mail addresses only when the destination mail address is a "phone number" or "phone number@docomo.ne.jp". For other kinds of mail addresses, secret codes cannot be added.
- You cannot set a secret code for the phonebook entries stored in the FOMA card.

1 Display the details screen for the phonebook entry for which you want to set a secret code.

How to search the phonebook →p.116

When multiple phone numbers or mail address are stored in a single phonebook

Press  to display the desired phone number or mail address.

2 Select "Secret code" from the function menu, and then enter the security code.



Security code →p.192

3 Select "Set code".



To check the set secret code

Select "Check code".

To cancel the set secret code

Select "Release code".

4 Enter the 4-digit Secret code.

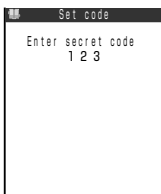

"0000" cannot be set.

Deleting an Entry in the Phonebook

Follow the procedure below to delete an entry stored in the phonebook. You can also select and delete only a phone number, mail address, address, memo, still image or movie from an entry.

To delete all or multiple entries in the Phonebook → p.132

1 Display the details screen for the phonebook entry you want to delete.

How to search the phonebook → p.116

To delete only a phone number, mail address, address, memo, still image or movie

Press  to display the item you want to delete.

2 Select “Delete data” from the function menu.

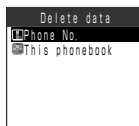

To delete a phonebook entry

Select “This phonebook”.

To delete only item displayed in Step 1

Select “Phone No./Mail address/Address/Memorandums/Delete image/Delete movie” according to the item to be erased or deleted.

NOTE

- You cannot delete the phonebook when “PIM lock”, “Keypad dial lock” or “Restrict dialing” is set.
- You can only modify the phonebook of secret data in “Secret mode” or “Secret only mode”.

Group setting

Changing a Group Name



Default setting FOMA terminal (main unit): Group 01 to Group 19
 FOMA card: Group 01 to Group 10

You can separate the phonebooks by use. For example, you can group them by category like “Companies” and “Friends” or hobby like “Baseball” and “Pottery”. Groups whose names can be changed and maximum number of characters are as follows:

	Groups whose names can be changed	Maximum number of characters
FOMA terminal (main unit)	Group 01 to Group 19	10 full-pitch or 21 half-pitch characters
FOMA card	Group 01 to Group 10	10 full-pitch or 21 half-pitch characters

- You cannot change the group name “Group 00”.
- You can set the “Utilities” functions for Group 01 to Group 19 in the FOMA terminal (main unit).
 → p.120

Changing a group name

1 Select   “Group setting”.

2 Select the group you want to change.



3 Enter a group name.

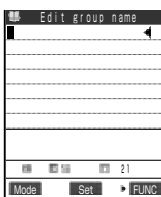



“” is attached to the groups in the FOMA card.

If you assign the same group name to the FOMA terminal (main unit) and FOMA card, the group is displayed as different two groups.

Entering characters → p.300

Resetting a group name

Reset group names you have changed to their default settings.

1 Select   “Group setting”.

2 Highlight the group name to reset, and select “Reset group name” from the function menu.



NOTE

- If you reset a group name, the “Utilities” setting set to the group is not canceled.

Saving the Phonebook in the FOMA Card

Data in the phonebook and SMS can be transferred between the FOMA terminal (main unit) and the FOMA card. You can also delete data in the phonebook and SMS stored in the FOMA terminal (main unit) and the FOMA card.

- During data copying or deleting, you cannot make or receive a voice/videophone call, or send or receive mail. In addition, you cannot activate other functions.
- Even in the “Secret mode” or “Secret only mode”, phonebook entries stored as secret data cannot be copied or deleted with this function.
- You cannot copy items that cannot be stored in the phonebook of the FOMA card. For items and the total number of stored items that can be copied, see p.106.

Copying data between the FOMA terminal (main unit) and FOMA card

Follow the procedure below to copy data in the phonebook and SMS between the FOMA terminal (main unit) and the FOMA card.

- Original data in the FOMA terminal (main unit) or the FOMA card remains after data copying.
- This function is not available when the FOMA card is not inserted.

1 Select ► “UIM operation”, and then enter the security code.

After the security code is entered, the terminal's communication function such as receiving a call is disabled and the “” icon appears.

If you receive a communication such as an incoming call before the security code is entered, the UIM operation ends.

Security code → p.192

2 Select “Copy”.

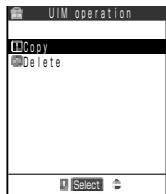

3 Select the direction in which the data is copied.

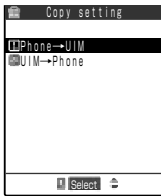

To copy data stored in the FOMA terminal (main unit) to the FOMA card

Select "Phone→UIM".

To copy data stored in the FOMA card to the FOMA terminal (main unit)

Select "UIM→Phone".

4 Select an item you want to copy.

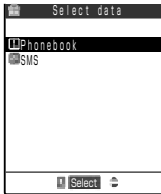

To copy phonebook data

Select "Phonebook".

Search the phonebook, and then display the phonebook list screen.

How to search phonebook →p.116

To copy SMS data

Select "SMS".

Select "Inbox" or "Outbox", and then display the SMS list screen.

5 Select the data to copy, and then press [Finish].



Phonebook

6 Select "YES".

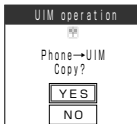

When you do not copy the data

Select "No".

NOTE

- When data that cannot be copied or the digits of a phone number is not compatible with the FOMA card, the message is displayed asking you whether to copy that data.
- If the maximum number of entries is already stored (saved) in the destination phonebook during copying, the message is displayed indicating you that data is full. Delete unnecessary data from those already stored (saved), and then copy the remaining data again.
- The number of phone numbers or mail addresses that can be stored as a single phonebook entry differs between the FOMA terminal (main unit) and the FOMA card. Therefore, the phone numbers or mail addresses stored as the second or subsequent ones in the FOMA terminal (main unit) phonebook cannot be copied to the FOMA card. Only the first phone number or mail address is copied and “☎” or “✉” icon appear.
- Since character types available with the FOMA terminal (main unit) and that with the FOMA card differ, some characters may be converted to spaces or different characters as follows.
 - When you copy the phonebook of the FOMA terminal (main unit) to the FOMA card, pictographs will be converted to spaces.
 - When you copy the SMS of the FOMA terminal (main unit) to the FOMA card, the pictographs other than “☎” and “✉” will be converted to spaces.
 - When you copy the phonebook of the FOMA card to the FOMA terminal (main unit), “フ” (full-pitch/lower case character) will be converted to “フ” (half-pitch/upper case character).
- When copying the FOMA card data that was stored using another FOMA terminal, the following characters are converted to spaces: the Latin and Greek characters and some symbols that are not half-pitch alphanumeric characters (excluding ◦「」、-° °), and full-pitch characters that are not in the Kuten code list.
- You cannot copy only SMS reports (p.199 in 『Application』). However, when the SMS report of a sent SMS is in the Inbox, if this sent SMS is copied, the SMS report saved in the sent SMS can also be copied.
- Display the phonebook details screen, and select “Copy to UIM” (or “Copy from UIM” when copying from the FOMA card) from the function menu to copy one entry at a time.
- Display the SMS details screen or highlight an SMS to copy on the SMS list screen, and select “UIM operation” from the function menu to transfer or copy one SMS at a time. →p.219 in 『Application』

Deleting data in the phonebook and SMS

Follow the procedure below to delete data stored in the FOMA terminal (main unit) and FOMA card. You can delete all data at once, or multiple data after selecting. To delete data in the Phonebook one by one → p.128

- 1** Select   “UIM operation”, and then enter the security code.

About security code →p.192

- 2** Select “Delete”.



3 Select the destination in which you want to save the deleted data.



To delete the data in the FOMA terminal (phone)

Select "Phone".

To delete the data in a FOMA card

Select "UIM".

4 Select the data to delete.

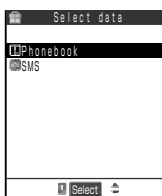

To delete phonebook data

Select "Phonebook".

Search the phonebook, and then display the phonebook list screen.

How to search phonebook → p.116

To delete SMS data

Select "SMS".

Select "Inbox" or "Outbox", and then display the SMS list screen.

5 Select the data to delete, and then press [Finish].



To delete all data

Select "Select all" from the function menu.

6 Select "YES".



When you do not delete the data

Select "NO".

Checking the Storage Status of the Phonebook

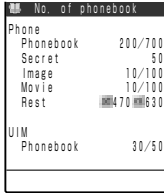

You can check the storage status of the phonebook such as the total number of entries stored and the remaining number of entries that can be stored.

1 Select   “No. of phonebook”.



No. of phonebook	
Phone	
Phonebook	200/700
Secret	50
Image	10/100
Movie	10/100
Rest	470/630
UIM	
Phonebook	30/50

Phone (Phonebook entries stored in the FOMA terminal)

- Phonebook** : Displays the number of entries stored.
Number of stored entries/700 (Maximum number of entries that can be stored)
- Secret** : Displays the number of entries stored as secret data.
Displayed only in the “Secret mode” or “Secret only mode”.
- Image** : Displays the number of images stored in the phonebook.
Number of stored images/100 (Maximum number of images that can be stored)
- Movies** : Displays the number of movies stored in the phonebook.
Number of stored movies/100 (Maximum number of movies that can be stored)
- Rest**  : Indicates the remaining number of phone numbers that can be stored.
-  : Indicates the remaining number of mail addresses that can be stored.

UIM (Phonebook entries stored in the FOMA card)

- Phonebook** : Displays the number of entries stored.
Number of stored entries/50 (Maximum number of entries that can be stored)

NOTE

- The number of entries stored in the Phone (FOMA terminal) phonebook include the number of secret data entries.

Turning Off Sounds Emitted by the FOMA Terminal

Manner mode provides a quick and convenient way of muting the FOMA terminal's ring tones and keypad sound to avoid disturbing people around you.

- Regardless of the manner mode setting, the shutter sound for taking a still image, the starting/ending sounds for recording movie and the self-timer starting sound are emitted.
- In the manner mode, vibration is used in place of the following sounds:
 - Ring tone*
 - Alarm tones for Alarm clock, Schedule and ToDo*
 - Missed calls Tone/New mail tone when the FOMA terminal is folded.
 - ※ : The FOMA terminal vibrates in the pattern specified in the "Vibrator" (p.167) setting. If the "Vibrator" is set to "OFF", the FOMA terminal vibrates in "Pattern 2".
- You can select any of the following 3 types of manner mode operation from the "Manner mode set": "Manner mode", "Super silent" and "Original". →p.136
- If the manner mode operation is set to "Original", the settings determine whether the alarm or tone sounds.

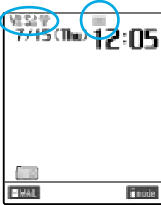

1 Hold down for 1 second or more while the standby display is displayed or during a call.







The manner mode is set and  appears.

While talking, a short double beep "pipipi" sounds and a message is displayed notifying you that the manner mode is set.

While the manner mode is set,  appears. In addition, the contents you have set in the "Manner mode set" also appears.

、、 : Indicates that the "Vibrator" (p.167) notifies you of an incoming call.

、、 : Indicates that the "Ring volume" (p.79) has been set to "Silent".

 -  : Indicates that the "Record message" (p.84) has been set to "ON". The number indicates the number of messages recorded.

To cancel the manner mode

With the manner mode set, hold down  for 1 second or more while the standby display is displayed or during a call.

Manner Mode is canceled and  disappears.

While talking, a short double beep "pipipi" sounds and a message is displayed notifying you that the manner mode is canceled.

Setting the manner mode while receiving a call <Quick record message>

If you press **#39#** or **[Memo/Check]** during an incoming call, the FOMA terminal enters the manner mode and activates the "Record message." (p.84) so that you can record the other party's message.

- Even if the "Record message" is not set to "ON", the "Record message" is activated.
- If the manner mode operation is set to "Original" and the "Record message" to "OFF", the "Record message" is activated.
- If there are already 5 messages, the FOMA terminal works according to the manner mode setting without activating the "Record message".
- When the call ends, the terminal is still in the manner mode. Hold down **#39#** for 1 second or more to cancel the setting.
- While "PIM lock" is set, even if you set the manner mode, the "Record message" is not activated.

Manner mode set

Changing the Manner Mode Setting

Default setting | Manner mode

You can select the FOMA terminal operation of when the manner mode is set.

● The default setting for "Original" is as follows:

- Record message : OFF
- Vibrator : ON
- Phone vol. : Silent
- Mail vol. : Silent
- Alarm vol. : Silent
- VM tone : ON
- Keypad sound : OFF
- Mic sensitiv. : Up
- LVA tone : OFF

1 Select **[Menu]** ▶ **[Incoming call]** ▶ **"Incoming call"** ▶ **"Manner mode set"**.

2 Select the item you want to set.

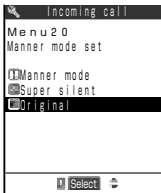

Proceed to step 3 when "Original" is selected.

Manner mode : Mutes all sounds emitted through the FOMA terminal's speaker. The ring tone and other tones are notified with the vibrator (vibration).

However, confirmation tones (when you press **[Memo/Check]** in the Voice memo or Play/Erase msg.) emitted through the earpiece speaker are not muted.

Super silent : Mutes all sounds emitted through the FOMA terminal's speaker and confirmation tones emitted through the earpiece speaker. The ring tone and other tones are notified with the vibrator (vibration).

Original : You can customize the way the FOMA terminal operates in the manner mode. For example, you can specify in advance how the terminal responds to incoming calls in the manner mode and the alarm volume for the alarm clock.

3 Specify the setting for each item.



- Record msg. : Specify whether the record message function activates (ON/OFF) when a call comes in.
Record message →p.84
- Vibrator : Specify whether to use the vibrator (ON/OFF) to notify you of incoming calls or alarms.
Vibrator →p.167
- Phone vol. : Set the ring volume for incoming voice/videophone calls.
Ring volume →p.79
- Mail vol. : Set the ring volume for incoming mail or message request/free.
Ring volume →p.79
- Alarm vol. : Set the alarm volume for the alarm clock.
Alarm clock →p.213
- VM tone : Specify whether to mute confirmation tones (ON/OFF) for the "Record message" and "Voice memo".
- Keypad sound : Specify whether to mute the keypad sound (ON/OFF).
- Mic sensitiv. : Specify whether to increase (Up/Normal) the sensitivity of the front mike during a call.
- LVA tone : Specify whether to mute the Low-voltage alarm (ON/OFF).

4 Press [Finish] and set the original manner.

In the manner mode

Each manner mode is set as follows:

	Manner mode	Super silent	Original (lists setting items in the Original)
Low-voltage alarm	OFF		Setting value of "LVA tone" Even when this is set to "ON", the Low-voltage alarm does not sound if the "Phone vol." in this function is set to "Silent".
Front mike sensitivity during a call*	Up		Setting value of "Mic sensitiv."
Ring volume for voice and videophone calls	Silent		Setting value of "Phone vol."
Ring volume for mail and message request/free	Silent		Setting value of "Mail vol."
Vibrator	ON		Setting value of "Vibrator"
Hold tone during a call or on hold	OFF		Setting value of "Phone vol." If this is set to other than "Silent", the tone sounds little.
Activating record message	OFF		Setting value of "Record msg."
Missed calls tone/New mail tone when the FOMA terminal is folded	OFF		Setting value of "Phone vol." If this is set to "Step", the tones sound at a constant volume.
Keypad sound	OFF		Setting value of "Keypad sound"
Alarm tone for alarm clock	Silent		Setting value of "Alarm vol."
Alarm tone for schedule/ToDo	Silent		Setting value of "Phone vol."
Starting/ending sounds for voice memo or record message	ON	OFF	Setting value of "VM tone"
Reading out for received mail	Setting value of "Phone vol." If this is set to "Step" or "Silent", the voice sounds little.		

* : When the Mic sensitiv. is set to Up, your voice can be heard clearly by the other party even when you speak quietly during a call. However, when filming movies with the "Camera", set the mike sensitivity to "Normal".

NOTE

- If you have set the vibrator to ON during the Manner mode, be careful that the FOMA terminal will not approach fire (e.g. a heater) or fall from a desk due to vibration of incoming calls.



Advanced Operations

Using Phone Functions	140
Changing Tone Settings	163
Changing the Display and Keypad Settings	170
Restricting Phone Operations	192
Using Alarm Notification Functions	209
Using Useful Tools	234
Using Other Functions	237
Multi Access/Multi Task	261

Setting the Time Until the Ringing Operation Starts

Default setting | Set mute seconds: 0 second | Missed calls display: Display

You can set a mute time for incoming calls from callers whose phone numbers are not stored in the phonebook between receiving the call and starting the ringing operation (notifying an incoming call). You can also set the FOMA terminal to not record such calls in missed calls to prevent unintentional callback from received calls to a nuisance call or malicious call with a short ringing time.

- The incoming call screen is displayed when a call comes in until the time specified in “Set mute seconds” has elapsed. No other call alert operations (playing a ring tone, vibrator, turning the incoming call lamp on) are performed. However, press  before the ringing operation starts to answer the call.

1 Select   “Incoming call”  “Ringing time”.

2 Select the item you want to specify.



To set a mute time until the ringing operation starts

Select “Set mute seconds”.

Set the start time in the range of 00 to 99 seconds. Enter the time as 2 digits.

To set whether missed calls during the mute time are displayed

Select “Missed calls display”.

Select the Missed calls display setting from “Display/Not display”.

NOTE

- When the following functions for restricting incoming calls are set at the same time, they are prioritized as follows. ① has the highest priority.
 - If you receive calls from callers whose phone numbers are notified.
 - ① Bar nuisance call service
 - ② Reject unknown/Call acceptance/Call setting w/o ID
 - ③ Driving mode
 - ④ Ringing time
 - If you receive calls from callers whose phone numbers are not notified.
 - ① Bar nuisance call service
 - ② Call rejection
 - ③ Driving mode
 - ④ Ringing time

Restricting Incoming/Outgoing Calls to/from Each Specified Number

Default setting | All canceled

To prevent personal calls from being made or to prevent nuisance calls, you can set restrictions for incoming calls and outgoing calls for each phone number stored in the phonebook.

You can set the following Restrictions functions:

Object		Function	Function description
Restrict outgoing calls	Prevent personal calls from being made.	Restrict dialing	You can only call specified phone numbers.
Restrict incoming calls	Prevent nuisance calls.	Call rejection	You cannot receive calls from specified phone numbers. “Call rejection” is valid when receiving data through 64K data communication.
		Call acceptance	You can receive calls only from specified phone numbers. “Call acceptance” is also valid for the videophone or when receiving data through 64K data communication.
	Set specified numbers to automatically be forwarded to a specified number or voice mail center.	Call forwarding	You can automatically forward calls from specified phone numbers to a specified phone number regardless of whether the “Call forwarding” is “Activate” or not. The call cannot be forwarded unless the destination is a videophone-support terminal that conforms to 3G-324M (p.87).
		Voice mail	You can set calls from specified numbers to automatically be forwarded to the voice mail service center regardless of whether the “Voice mail” is “Activate” or not. The incoming videophone call continues without connected to the voice mail service center.

- You can specify up to 20 phone numbers for each function.
- You cannot set the restrictions functions for the phonebook entries stored in the FOMA card.
- When the caller sends no caller ID, the restrictions functions are disabled. The “Caller ID request” service (p.286) and “Call setting w/o ID” (p.145) are useful if you have set them.
- You cannot set both the “Call rejection” and “Call acceptance”, or the “Call forwarding” and “Voice mail” to the same phone number at the same time.
- You cannot set this to the phonebook saved in “Secret mode” or “Secret only mode”.
- Changing or deleting specified numbers on phonebook will cause the Restriction functions to cancel. However, if “Restrict dialing” has been set, you cannot change or delete any numbers in your Phonebook.

Setting restrictions to phone numbers for incoming/outgoing calls

The procedures to set restrictions to phone numbers stored in the phonebook for incoming/outgoing calls are the same way.

1 Display the phonebook details screen you want to set.

How to search the phonebook →p.116

2 Select “Restrictions” from the function menu, and then enter the security code.



Security code →p.192

3 Select the function you want to set.

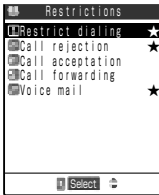

The “★” mark is attached to the set function.

To cancel the set function

Select the function with the “★” mark.

The function is canceled and the “★” mark disappears.

To set each function of restricting incoming/outgoing calls to multiple phone numbers

Press **CLR** to go back to the phonebook details screen and display the phone number you want to set by pressing **OK**, and then follow steps 2 and 3.

If you go back to the standby display by pressing **END**, you cannot additionally set the “Restrictions”. In that case, first cancel all the “Restrictions” settings from the phone numbers already set, and then specify it to an additional one as well as to the canceled ones.

NOTE

<Restrict dialing>

- When you set “Restrict dialing”, the following operations are disabled: storing, modifying, copying between FOMA terminal (main terminal) and FOMA card, phonebook operation using the “UIM operation”, all the dial calling including the specified phone numbers, and calling from the received calls.
- When you set “Restrict dialing”, the “Dialled calls” and “Redial” are deleted. The dialed calls after this function is set will be recorded in the “Dialled calls” or “Redial”.
- If you want to use the “Automatic display” (p.125) together with “Restrict dialing”, set this function to the phonebook entry specified for the “Automatic display”.
- Note that “Restrict dialing” may become invalid when you send data from an external device such as a PC.
- Even if “Restrict dialing” has been set, you can make an emergency call (e.g. 110, 119, and 118).

<Call rejection/Call acceptance>

- “Call rejection” and “Call acceptance” become valid only when the caller notifies you his/her caller ID. It is recommended that you should set the “Caller ID request” service (p.286) and “Call setting w/o ID” (p.145).
- “Call rejection” and “Call acceptance” become valid when receiving data through 64K data communication (p.386 in 『Application』).
- You can receive i-mode mail or SMS regardless of “Call rejection” and “Call acceptance” functions.
- When “PIM Lock” (p. 204) is set, the call rejection and call acceptance are disabled.
- When receiving a call from the caller whose phone number is set to Call rejection or is other than those set to Call acceptance, this call is recorded as “Missed call” in “Received calls” (p.151) and the “Missed call” desktop icon appears on the standby display.
- When you are receiving a call from the caller whose phone number is set to Call rejection or is other than those set to Call acceptance, even if you set the “Voice mail” service (p.273) or “Call forwarding” service (p.278) to “Activate”, the call is rejected. However, if you set the ringing time to 0 second for the “Voice mail” service or “Call forwarding” service, or if you are outside the service area or the power is turned off, the “Voice mail” service or “Call forwarding” service is activated. Note that this call is not recorded in “Received calls” and no “Missed call” desktop icon appears on the standby display.

<Call forwarding/Voice mail>

- “Call forwarding” and “Voice mail” become invalid when the “PIM lock” is set.
- If you have a call from the caller whose phone number is set to Call forwarding or Voice mail, the ring tone sounds for 1 second and then the call will be forwarded to the specified phone number or voice mail service center. In this case, the call is recorded as “Missed call” in “Received calls” (p.151) and the “Missed call” desktop icon appears on the standby display. Note that the operational priority is given to “Call forwarding” and “Voice mail” over the “Call waiting” service and “Arrival call act”.
- When the forwarding number is not set, or if you do not subscribe to the “Call forwarding” service or “Voice mail” service, the call from the number set to the “Call forwarding” will be a “Missed call”.

Checking the Restrictions settings

You can check the phone numbers on which “Restrictions” have been set for each function. You can also cancel the functions that have been set while checking the restrictions settings.

1 Select “Restrictions”, and then enter the security code.

Security code →p.192

When no phone number is set

A message notifying you that there is no set phone number appears.

2 Select a function with the “★” mark.

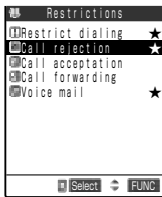

The phonebook list screen for the selected set function appears.

To cancel all the phone numbers on which the function has been set at once

Highlight the function with “★” mark, and then select “Release settings” from the function menu.

3 Select the phonebook entry you want to check for the phone number.



The phone number of the selected entry appears.

To cancel the Restrictions setting

Select the phone number you want to cancel.

Reject unknown

Rejecting Calls from the Phone Number not Stored in the Phonebook

Default setting | **Accept**

You can set the FOMA terminal to reject incoming calls from phone numbers not stored in the FOMA terminal (main unit) and FOMA card phonebooks.

- When the caller sends no caller ID, or when “PIM lock” is set, this function is disabled.

1 Select “Lock/Security” “Reject unknown”, and then enter the security code.

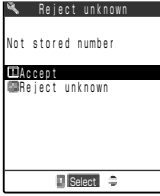

Security code →p.192

To accept incoming calls from phone numbers not stored in the phonebook

Select “Accept”.

To reject incoming calls from phone numbers not stored in the phonebook

Select “Reject”.

NOTE

- When this function is set to “Reject”, if you receive a call from the caller whose phone number is stored in the phonebook, this call is recorded as “Missed call” in the “Received calls” (p.151) and the “Missed call” desktop icon appears on the standby display.
- When the following functions for restricting incoming calls are set at the same time, they are prioritized as follows. ① has the highest priority.
 - If you receive calls from callers whose phone numbers are notified.
 - ① Bar nuisance call service
 - ② Reject unknown/Call acceptance/Call setting w/o ID
 - ③ Driving mode
 - ④ Ringing time
 - If you receive calls from callers whose phone numbers are not notified.
 - ① Bar nuisance call service
 - ② Call rejection
 - ③ Driving mode
 - ④ Ringing time

Call setting w/o ID

Rejecting Calls with No Caller ID

Default setting **Accept/Same as ring tone**

You can set the FOMA terminal to reject incoming calls according to the reason for no caller ID.

1 Select “Lock/Security” “Call setting w/o ID”, and then enter the security code.

Security code →p.192

2 Select the reason for no caller ID you want to set.



Not supported : Set whether to connect (Accept) or not connect (Reject) an incoming call from the network that cannot send the caller ID, such as a call from overseas or a forwarded call from a general phone.

However, depending on the intermediary phone companies, the caller ID may be informed.

Payphone : Set whether to connect (Accept) or not connect (Reject) an incoming call from a pay phone.

“Payphone” appears when a call arrives from an NTT pay phone, etc.

User unset : Set whether to connect (Accept) or not connect (Reject) an incoming call from a caller who deliberately notifies no caller ID.

3 Select the item you want to set.

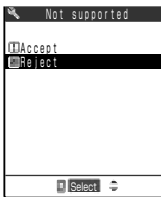

To accept incoming calls from phone numbers those do not notify the caller ID

Select “Accept”, and select a ring tone from the Select ring tone screen.

Selecting a ring tone → p.163

To reject incoming calls from phone numbers those do not notify the caller ID

Select “Reject”.

NOTE

- When receiving a call with no caller ID whose no caller ID reason has been set to “Reject”, this call is recorded as “Missed call” in the “Received calls” (p.151) and the “Missed call” desktop icon appears on the standby display.
- If you receive a call with no caller ID whose no caller ID reason has been set to “Accept”, the reason for no caller ID appears.
- If you set “Same as ring tone” to a ring tone when “Accept” is set, the ring tone specified in “Phone” of “Select ring tone” sounds.
- If you receive a videophone with no caller ID, the ring tone specified in “Video-phone” of “Select ring tone” sounds.
- You can receive i-mode mail or SMS regardless of “Call rejection” and “Call acceptance” functions.

Pause dial

Sending Push Signals for Easy Operation

You can send a message to the QUICKCAST*, make a ticket reservation or check your bank account balance by sending push signals from your FOMA terminal.

Storing dial data using the pause dial function

Store dial data to be sent as push signals in the pause dial in advance. Inserting a pause (p) allows you to send dial data with a pause where you pressed the pause key.

- You can store only one set of dial data, each can contain up to 128 characters.
- You can enter the following characters for dial data : 0 to 9, #, * and a pause (p).
- You cannot insert a pause (p) at the beginning of dial data or successively.
- If you insert a pause (p) at the end of dial data, the pause will automatically be deleted when storing the dial data.

1 Select   “Other settings” ▶ “Pause dial”.

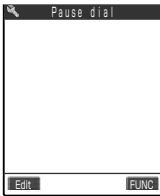

When dial data is already stored
The stored dial data is displayed.

2 Press  [Edit] and enter the dial data.

Press  to ,  and , and then enter the dial data.

To insert a pause (p)

Hold down  for 1 second or more.

Sending dial data using the pause dial function

1 Select   “Other settings” ▶ “Pause dial”.

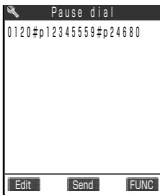



To delete dial data
Select “Delete” from the function menu.

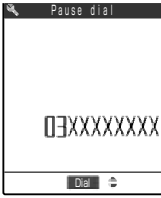

2 Press [Send] and enter the destination phone number.



To enter the phone number from the phonebook

Enter part of the phone number, and then press  to search for the number.

Press  to select a search method from the phonebook search screen.



Press  to search the received call record, or  to search the redial record.

3 Press or [Dial].



A call is made to the entered phone number, and when the call is connected, the stored dial data until the first pause (p) is displayed. No pause (p) appears.



4 Press or [Send] to send the dial data.

Each time you press  or  [Dial], dial data until the next pause (p) is sent. Once the last number is sent, the talking screen reappears.

To send all dial data at one time

Hold down  for 1 second or more, and select "Send at one time" from the Send pause dial menu.

NOTE

- You can send dial data to the other party you are talking by displaying the pause dial screen during a call and pressing  [Send].
- You can also send dial data by entering the pause dial directly on the standby display. In this case, first dial the other party's phone number, enter a pause (p), and then enter dial data you want to send. After entering, press  to make the call. Once you are connected, press  again to send the dial data until the next pause (p).
- The videophone call disables the pause dial and you cannot send dial data after the pause.
- The signal may not be received depending on the device of the called side.

Attaching a Number Before the Phone Number

Default setting "WORLD CALL" (009130010)

You can set your frequently called numbers (prefix) in advance. Once you have set, you can dial a phone number with a prefix at its head by using "Dialing", "Phonebook", "Received calls", "Dialled calls" or "Redial". The number for "Notify caller ID", etc. is useful if you have set it.

- Up to 7 prefixes can be stored.
- You can enter the following characters for a prefix number: 0 to 9, # and *.

1 Select   "Other settings" ▶ "Prefix setting".

2 Highlight <Not stored> and then press  [Edit].



To change the contents of a stored prefix

Select a prefix name you want to change.

To delete a prefix

Highlight the item you want to delete, and select "Delete this" from the function menu.

To delete all prefixes

Select "Delete all" from the function menu.

3 Enter the entry name.

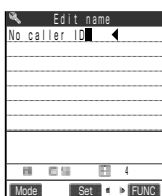

Up to 8 full-pitch or 16 half-pitch characters can be entered for a prefix name.

Entering characters →p.300

4 Enter the number (prefix).

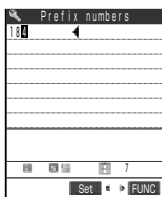

The prefix number can be up to 10 digits long.

NOTE

- You can add a prefix to a phone number by selecting “Prefix” from the function menu when dialing, or displaying the phonebook details screen, “Received calls”, “Dialled calls” and “Redial”.
- You can edit the preset “WORLD CALL” (009130010) stored at purchase.

Subaddress setting

Setting for Subaddress SupportDefault setting **ON**

You can use “X” in a phone number as the delimiter and set the number after “X” as a subaddress. A subaddress is used for specified communication to a certain communication device through ISDN or the content selection from the “M-stage V Live”.

1

Select

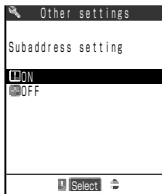

“Other settings” ▶ “Subaddress setting”.

**To activate the Subaddress function**

Select “ON”.

To deactivate the Subaddress function

Select “OFF”.

NOTE

- In the following cases, “X” does not work as the subaddress delimiter and is recognized an ordinary phone number including “X”.
 - “X” is placed at the beginning of a phone number.
 - “X” is placed immediately after the prefix number “186/184”.
 - When there is a “X” mark right after the numbers entered in “Prefix”.

Using Dialed or Received Calls Records

When you make a call or receive a mail, your FOMA terminal records the caller's phone number or the sender's mail address as a record. You can use those records to check the caller or the sender, call a recorded phone number, or send a mail to a recorded mail address.

Using dialed/received calls record

Information such as a phone number you called, the caller's phone number and date and time is recorded as the dialed or received call record. If you cannot answer a call, the call is recorded as the missed call record. Voice calls, videophone calls, packet communication and 64K data communication for the dialed/ received/ missed call records are distinguished with their icons so that you can see the type of a record at a glance.

- Up to 30 dialed voice/videophone calls and up to 30 sent packet/64K data communications for a total of 60 records can be recorded in the dialed record. Likewise, up to 30 received voice/videophone calls and up to 30 received packet/64K data communications for a total of 60 records can be recorded in the received call record
- When the number of records exceeds the maximum number, the oldest records are automatically deleted.
- The dialed/received call record cannot be displayed during a videophone call.
- The access point (APN) of the sender is displayed for received packet communication.
- No date and time is recorded when the date and time is not set in "Set time".

The differences between Dialed calls record and Redial

There are the differences between Dialed calls record and Redial.

	Dialed calls record	Redial
Type of record that is stored	Voice call, videophone call, packet communication, 64K data communication	Voice call, videophone call
When you call the same phone number	Stored as a separate record	Overwritten and stored as the most recent call

※: When you perform "Delete all", both "Redial" and "Dialed calls" will be all deleted. Even if you perform "Delete this" or "Delete selected" for the Dialed calls, the redial is not deleted. Note that the records of the redial remain. Deleting the redial →p.73

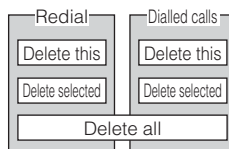

<Example: Using the received calls>

1 Select   "Received calls".

You can also call up "Received calls" by pressing .

To use the dialed calls record

Select "Dialed calls".

2 Select the display type of received calls.

Received calls	
All calls	20
Missed calls	08
Unknown calls	3

Select

To display all received call records

Select "All calls".

To display missed calls records only

Select "Missed calls".

Unknown calls shows the number of records which have not been checked.

3 Select the record that you want to see.

Received calls 1/4	
7/15 11:34	TodaShunji
7/15 8:40	SugimotoMikiko
7/14 18:15	08XXXXXXXX
7/14 15:23	NakanishiTetsuya
7/12 22:46	TodaShunji

Change Select +> FUNC

To delete a record

Highlight the record you want to delete, and select "Delete this" from the function menu.

To delete multiple records

Select "Delete selected" from the function menu, and then select the records you want to delete.

To delete all records

Select "Delete all" from the function menu.

To display the ringing time for missed calls from all calls list screen

Select "Ringing time" from the function menu.

Only missed calls with each ringing time are displayed on the list screen. Press  to return to the received calls list screen.

Check the contents of a record.

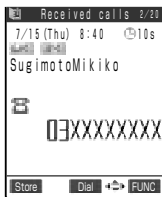

“Current record number/Total record number” appears in the upper right corner of the screen. The smaller the record number, the newer the record. In case of missed calls, the ringing time is displayed next to the date and time.

To check the previous and next records

Press or .

Press to display the previous (later) record, to display the next (older) record.

However, for the dialed calls record, press to display the previous (later) record, to display the next (older) record.

To make a voice call to the displayed phone number

Display the record for which you want to make a voice call and press .

To make a videophone call to the displayed phone number

Display the record for which you want to make a videophone call and press .

To set an image to be sent during a videophone call

Select “Select image” from the function menu.

If you select “Me”, the image of the in-camera will be sent. About other substitute images, see p.98.

To store the displayed phone number in the phonebook

Display the phone number you want to store, and select “Add to phonebook” from the function menu.

Storing data in the phonebook → p.108

To send an i-mode mail from a record

Display the record from which you want to send an i-mode mail, and select “Compose message” from the function menu.

Displays a new mail creation page with the mail address stored in a phonebook entry entered in the address field.

Composing i-mode mail → p.154 in 『Application』

Dialed/Received calls record icons



: Indicates that you made a voice call or had an incoming voice call.



: Indicates that you made a videophone call or had an incoming videophone call.



: Indicates that you had an incoming videophone call for the remote monitor.



: Indicates that you made a call for the packet communication.



: Indicates that you had an incoming call, etc. for the packet communication.



: Indicates that you made a call for the 64K data communication.



: Indicates that you had an incoming call, etc. for the 64K data communication.

Missed calls record icons



: Indicates that you did not answer a voice call.



: Indicates that you did not answer a voice call, and the caller left the message in “Record message”.



: Indicates that you did not answer a videophone call.



: Indicates that you did not answer a videophone call, and the caller left the message in “Record message”.



: Indicates that you did not connect to a videophone call for the remote monitor.



: Indicates that you did not answer an incoming call, etc. for the packet communication.



: Indicates that you did not receive an incoming call, etc. for the packet communication.



: Indicates that you did not answer an incoming call, etc. for the 64K data communication.



: Indicates that you did not receive an incoming call, etc. for the 64K data communication.



: Indicates that it is an unchecked missed call.

NOTE**<Common>**

- Switching the terminal off does not delete Dial records/Received calls. If you do not want other people to see the Dialed/Received phone numbers, either delete the record or set "Received calls" and "Redial/Dialed calls" in "Record display set" (p.206) to "OFF".
- When you receive a call while displaying Received calls, the record data may be updated and a message "Updating info" may appear. You cannot switch to other record displays while this message is showing.
- While "PIM lock" is set, only phone numbers are recorded even for calls to/from parties whose names are stored in the phonebook.

<Dialed calls record>

- When making calls by calling up a phonebook stored as secret data in the "Secret mode" or "Secret only mode", these calls are not recorded in the dialed record.
- When you set "PIM lock", "Keypad dial lock" or "Restrict dialing", all the dialed records until then are deleted. The dialed calls after these functions are set will be recorded in the dialed record.

<Received calls record>

- "Missed calls" and "Unknown calls" are not displayed if there are no missed calls.
- The number of missed calls which have not been checked in yet will decrease as you check in.
- When the caller notifies his/her phone number, and the caller's phone number has already stored in the phonebook, both the phone number and name are recorded in the received call record. If the caller does not notify the phone number, the reason for no caller ID appears.
- When you set "PIM lock" or "Keypad dial lock", all the received call records are deleted. After these functions are set the received calls will be recorded in the received call record.
- When a call comes from a party that is not in the phonebook set in "Restrict dialing" if "Restrict dialing" is set, only the phone number is recorded.
- When the other party uses the dial-in service, the different phone number from its dial-in number may appear.
- You cannot use the received call record for packet and 64K data communication for storing data in the phonebook or composing a new mail.

Using sent/received address record

Information such as a mail address you sent, the sender's mail address and date and time is recorded as the sent/received address lists. You can check the contents of the sent/received address list and use them for composing and sending a mail and storing a phone number in the phonebook. In addition, i-mode mail and SMS are distinguished with their icons in the sent/received address lists so that you can see the type of a record at a glance.

- Up to 30 records such as i-mode mail addresses and SMS phone numbers can be recorded in the sent/received address lists respectively.
- When the number of records exceeds the maximum number, the oldest records are automatically overwritten.
- The sent/received address lists cannot be displayed during a videophone call.

<Example: Using the sent address record>

1 Select   "Dialed calls".

To use the received address record
Select "Received calls".

2 Press [Change].



The sent address list appears.

3 Select the address that you want to see.



To delete an address

Select the record you want to delete, and select “Delete this” from the function menu.

To delete multiple addresses

Select “Delete selected” from the function menu, and then select the records you want to delete.

To delete all addresses

Select “Delete all” from the function menu.

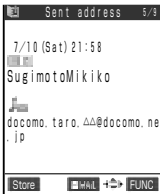

4 Check the contents of the address.





“Current address number/Total address number” appears in the upper right corner of the screen. The smaller the address number, the newer the address.

To check the previous and next addresses

Press  or .

Press  to display the previous (later) address,  to display the next (older) address.

However, for the received address list, press  to display the previous (later) record,  to display the next (older) record.

To send an i-mode mail to the displayed mail address

Display the address for which you want to send an i-mode mail, and select “Compose message” from the function menu.

Composing i-mode mail → p.154 in 『Application』

To store the displayed phone number or mail address in the phonebook

Display the phone number or mail address you want to store, and select “Add to phonebook” from the function menu.

How to store data in the phonebook → p.108

To make a voice call to the displayed phone number

Display the address you want to call and select from the function menu “Dialing” – “Voice phone”.

Make a call to the phone number stored at the top of the phonebook.

To make a videophone call to the displayed phone number

Display the address you want to call and select from the function menu “Dialing” – “32K V-phone” or “64K V-phone”.

NOTE

- Switching the terminal off will not delete sent/received address lists. If you do not want to other people to see your sent/received addresses, either delete them or set “Received calls” and “Redial/Dialled calls” in “Record display set” (p.206) to “OFF”.
 - When you receive a mail while displaying the received address list, you will see a message “up date” until the receiving process is complete. You cannot switch to other record displays while this message is showing.
 - When you set “PIM lock” or “Keypad dial lock”, all the sent/received address lists are deleted. The mail addresses sent/received after these functions are set will be recorded in the sent/received address lists.
 - When the security is set to the Inbox or Outbox with “Security”, sent addresses are not recorded. Likewise, mail addresses stored in the phonebook as secret data in the “Secret mode” or “Secret only mode” are not recorded in the sent address list.
- <Sent address record>
- For addresses in the phonebook set with secret codes, the data except for the secret codes are displayed in the sent address record.

Sent address record icons



: Indicates that you sent an i-mode mail.



: Indicates that you sent an i-mode mail and its transmission failed.



: Indicates that you sent an SMS.



: Indicates that you sent an SMS and its transmission failed.

Received address record icons



: Indicates that you received an i-mode mail.



: Indicates that you received an SMS.

Noise reduction

Making Your Phone Conversation Clearer

Default setting ON

The Noise reduction is a function that reduces ambient noise. This function enables to send your clear voice to the other party during a voice or videophone call even in the noisy place.

1

Select  ▶  ▶ “Talk” ▶ “Noise reduction”.

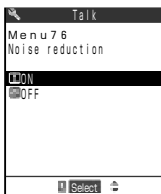

To activate the Noise reduction
Select “ON”.

To deactivate the Noise reduction
Select “OFF”.

Reconnect control

Setting Notification of a Dropped Line

Default setting | No tone

Even if your connection drops out due to poor radio wave condition, the FOMA terminal automatically tries to reconnect to the dropped phone number as soon as reception is restored. You can also set the alarm tone ringing pattern when a call is reconnected.

- During i-mode operation, no alarm sounds regardless of the “Reconnect control” setting.
- The wait time for call reconnection differs depending on radio wave condition and how the phone is used. In general, reconnection is possible in about 10 seconds.
- If radio wave condition suddenly becomes bad, a call may be disconnected with no alarm.

1 Select   “Talk”  “Reconnect control”.

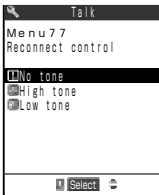

Not to sound an alarm

Select “No tone”.

To sound a high-tone alarm

Select “High tone”.

To sound a low-tone alarm

Select “Low tone”.

NOTE

- Waiting for call reconnection (in about 10 seconds at the longest) is also charged.
- The other party hears no sound during disconnection.

Setting Alarm Notification of a Bad Connection

Default setting | High tone

The FOMA terminal notifies you with an alarm tone immediately before a call is to be disconnected due to an exceedingly weak radio wave while you are talking on the voice call. It is useful for taking appropriate countermeasures such as moving to a place where radio wave conditions is good or ending the call and redialing with the other party's permission before the call is disconnected.

- If radio wave condition suddenly becomes bad, a call may be disconnected with no alarm.
- This function does not work with a videophone call.

1 Select   "Talk"  "Quality alarm".

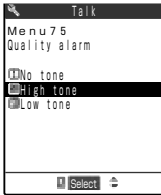

Not to sound an alarm

Select "No tone".

To sound a high-tone alarm

Select "High tone".

To sound a low-tone alarm

Select "Low tone".

Selecting the Guidance for Holding Calls

Default setting | On hold tone: Tone 1 | Holding tone: Melody

You can select a guidance message to be played while an incoming voice/ videophone call or the current call is put on hold.

You can set the following guidance messages:

Item	Type of guidance	Guidance description
On hold tone	Tone 1	"Sorry, unable to respond now. Wait or call later." (in Japanese)
	Tone 2	"Sorry, unable to respond now. Call later." (in Japanese)
	Voice announce 1 [※] , Voice announce 2 [※]	Your message recorded with the "Voice announce" → p.249
Holding tone	Melody	—
	Voice announce 1 [※] , Voice announce 2 [※]	Your message recorded with the "Voice announce" → p.249

※ : Voice announce 1 or Voice announce 2 cannot be set unless you record voice with the "Voice announce".

1 Select   "Talk"  "Select hold tone".

2 Select the item you want to set.

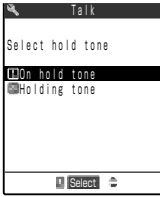

To set an on hold tone
Select "On hold tone".

To set a holding tone
Select "Holding tone".

3 Select a guidance message you want to set.

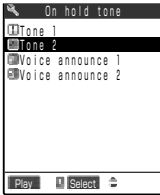

On hold tone

To hear a guidance message

Press [Play].

You will hear guidance once.

Press to stop the guidance.

Answer setting

Setting to Stop the Ring Tone Quickly

Default setting | Any key answer

You can set your FOMA terminal to stop its ringing tone immediately when a call comes in. It is useful for answering an incoming call in a place where this may bother people around you.

You can set the following operations:

Item	Description
Any key answer	You can press any of the following keys to answer an incoming call: to , , , , , or as well as . However, videophone calls are not supported.
Quick silent	You can stop the ring tone and vibrator by pressing any of the following keys or opening the FOMA terminal when a voice or videophone call comes in: to , , , , or . Even if the ring tone has been muted, the other party still hears the ring tone. For an incoming voice call, you can answer the call by pressing or [Answer]. For an incoming videophone call, you can answer the call by pressing with the camera view or by pressing or [Answer] with a substitute image.
OFF	For an incoming voice call, you can answer the call only by pressing or [Answer]. For an incoming videophone call, only by pressing , or [Answer] (When you press or [Answer], you can respond to the videophone call with a substitute image.).

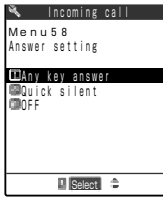

1

Select  ▶  ▶ “Incoming call” ▶ “Answer setting”.



To answer a call with the any key answer mode
Select “Any key answer”.

To answer a call with the Quick silent mode
Select “Quick silent”.

To answer a call by only pressing ,  [Answer] or 
Select “OFF”.

NOTE

- Even if you set to “Quick silent”, when the “Manner mode” is on, the FOMA terminal operates during the “Any key answer” mode.
- Even if this function is set to “Quick silent...” will not appear in case a call comes from the caller in which images are stored in the phonebook when the videophone and “Display phonebook image”(p.181) are set to “ON” or in case a movie ringtone is set to “ON”.

Fold setting

Setting Operations When the FOMA Terminal is Folded During a Call

Default setting | End the call

You can set how your FOMA terminal operates when it is folded during a voice or videophone call.

You can set the following operations:

Item	Description
No tone	During a voice call, voice is muted. During a videophone call, voice is muted and the “Camera off” (p.98) is sent to the other party. No hold tone sounds. Unfolding the FOMA terminal returns to the previous conditions. However, if you fold the FOMA terminal while holding and then unfold it again, the terminal returns to the usual call condition.
Tone on	A call is put on hold (holding). During a voice call, the other party hears the hold tone set in the “Select hold tone” (p.158) while your FOMA terminal is folded. The hold tone can also be heard from your FOMA terminal speaker. During a videophone call, the hold tone set in the “Select hold tone” is played and the my image sending (p.98) is sent to the other party. Unfolding the FOMA terminal returns to the previous conditions. However, if you fold the FOMA terminal while holding and then unfold it again, the terminal returns to the usual call condition.
End the call	A call is terminated. This has the same effect as pressing  .

- When the earphone/microphone with switch is connected, this function is disabled. Folding the FOMA terminal during a call does not change the call status. However, during a videophone call with camera view, folding the FOMA terminal switches to the substitute image.

1

Select  ▶  ▶ “Incoming call” ▶ “Fold setting”.

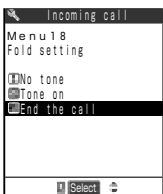

To mute voice when the FOMA terminal is folded
Select “No tone”.

To play a hold tone when the FOMA terminal is folded
Select “Tone on”.

To end a call when the FOMA terminal is folded
Select “End the call”.

NOTE

- Even if you set to “No tone” or “Tone on”, this function is disabled while a voice memo is recorded.
- Even if you set to “Tone on”, when you fold the FOMA terminal while you are talking to the 2nd person using the “Call waiting” (p.281), “No tone” works.

Call time display

Displaying the Call Duration During a Call

Default setting | ON

You can set whether to display the current call duration during a voice or videophone call.

- When the call duration exceeds “19h59m59s”, the count will start from “00s”.
- The displayed call duration is a rough estimation, so it may differ from the actual call duration.
- The communication time for i-mode and packet communication is not counted.

1

Select   “Call data” ▶ “Call time display”.

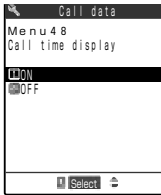

To display the call duration during a call
Select “ON”.

Not to display call duration during a call
Select “OFF”.

Checking/Resetting the Total Call Duration

You can check the call duration of your last call and the total call duration for voice and videophone calls, and reset them to “0”. It is useful for checking the total call duration for voice calls and digital calls separately or checking the monthly total call duration.

Checking the call duration

You can display and check the call duration of your last call, the total call duration and the date and time when the call duration was last reset for voice calls, videophone calls, and 64K data communication.

- When the all calls duration exceed “199h59m59s”, the count will start from “00s”.
- The displayed call duration is a rough estimation, so it may differ from the actual call duration.
- The communication time for i-mode and packet communication is not included in the call duration.

1

Select   “Call data”  “Call duration”.

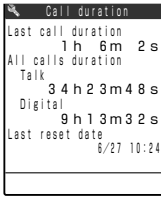

- Last call duration : Displays an estimation of the call duration on your immediate last made or received call.
- All calls duration : Displays the total call duration since the last reset (reset to “00s”). “Talk” indicates the total call duration of voice calls, while “Digital” indicates that of videophone calls and 64K data communication.
- Last reset date : Displays the date and time when the call duration was last reset.

NOTE

- If the power is turned off or the FOMA card is removed, the display of the last call duration becomes “00s”.
- Turning the FOMA terminal off does not delete the all calls duration information.
- The last reset date shows “-/-/ -:-:--” in case of default or when date and time are not set in the “Set time”.

Resetting the call duration

You can reset the last call duration and the all calls duration displayed in the “Call duration” to zero.

1

Select   “Call data”  “Reset call duration”, and then enter the security code.

Security code →p.192

2

Press  [Select] and select “YES”.

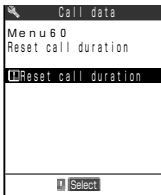

To cancel resetting
Press  [Select] and select “NO”.

NOTE

- You can check the date and time when the call duration was last reset on the “Call duration”.



Selecting a Ring Tone for Incoming Calls and Mail

Default setting Phone: Pattern 1 Video-phone: Pattern 1 Mail: Pattern 2
Msg. Request: Pattern 3 Msg. Free: Pattern 3

You can set a different ring tone for incoming voice calls, videophone calls, mail, Msg. Request and Msg. Free. You can also set each different ring tone for calls/mail from a specified phone number/mail address/group in the phonebook.

→p.120

- You can set i-motion downloaded from a site or Web page to the ring tone.
- You cannot set “i-motion”(movie ringtone) for mail, Msg. Request/Free and 64K data communication.
- When you receive mail, Msg.Request/Free while the screen is displayed other than the standby display, the ring tone will not sound.
- To set “Voice announce 1” and “Voice announce 2”, you must first record your message with the “Voice announce”.
- While “PIM lock” is set, data other than pre-installed patterns, sound effects and melodies cannot be set. While “PIM lock” is set, you cannot set movie ringtone to the ring tone.

1 Select   “Incoming call”  “Select ring tone”.

2 Select the item for which you want to set a ring tone.

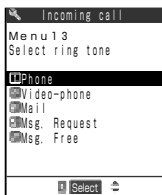

- Phone : Sets a ring tone for voice calls and 64K data communication
- Video-phone : Sets a ring tone for videophone calls
- Mail : Sets a ring tone for i-mode mail, SMS and packet communication
- Msg. Request : Sets a ring tone for Msg. Request
- Msg. Free : Sets a ring tone for Msg. Free

3 Select a ring tone category.



- Melody : Select from the 3 preset patterns, 8 sound effects, and 10 melodies in “Pre-installed” folder or a maximum of 160 melodies downloaded from sites and Internet websites located in the “INBOX” or your original folder.
- i-motion : Select an i-motion video clip you have imported/downloaded to your FOMA terminal from [INBOX], [Pre-installed] folder or folders you have created. When a call comes in, sounds and images are played in accordance with the selected i-motion (movie ringtone function).
i-motion (movie ringtone) cannot be selected to specify for the ring tone of mail, message request/free and 64k data communication.
About the movie ringtone function → p.101 in [Application]
- Voice announce : Select a ring tone from “Voice announce 1” or “Voice announce 2” recorded with the “Voice announce” (p.249) function. When a call comes in, your recorded voice plays.
- Random melody : Select a folder in which melodies are saved. When a call comes in, the stored melodies are randomly selected and played.
- OFF : No ring tone sounds.

4 Select a melody to be set as a ring tone.

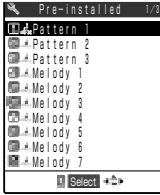

- Highlight the melody to play the melody. Press any button of , , , or to stop.
- When selecting i-motion**
Press [Play] to play the selected i-motion.

Pre-installed ring tone/melody list

Display
Pattern 1-3
Melody 1
Melody 2
Melody 3
Melody 4
Melody 5
Melody 6
Melody 7
Melody 8
Melody 9
Melody 10
Alarm 1
Alarm 2
Alarm 3
Alarm 4
Alarm 5
Alarm 6
Alarm 7
Alarm 8

Permit No.: T-0440033 

Pre-installed movie ringtone list

Display
i motion 1 *

Permit No.: T-0001633JRCL 

Music : Provided by Sony Music Records Inc.

*This is a song for movie ringtone which is stored in the "Pre-installed" folder in "i-motion".

NOTE

- You can only set the preset ring tone while the “PIM Lock” is set. However, you cannot set the preset movie ring tone.
- When you receive a call during “PIM lock”, if the ring tone is set to data or file other than pre-installed ring tones, the ring tone of the default setting sounds.
- When the vibration pattern is set to “Melody linkage” in “Vibrator” (p.167), if a melody with vibration pattern specified is set to the ring tone, the FOMA terminal vibrates in accordance with the pattern of the melody. The FOMA terminal does not vibrate in accordance with movie ring tone.
- When the flashing pattern is set to “Melody linkage” in “Illumination” (p.185), if a melody with illumination pattern specified is set to the ring tone, the incoming call lamp flashes in accordance with the pattern of the melody. The incoming call lamp does not flash in accordance with movie ring tone.
- If “Ring tone” is set in the Melody player, the same setting applies to “Ring tone” of the “Select ring tone”. →p.341 in [Application]
- If “Ring tone” for “Phone” and “Video-phone” are set in the Movie player, the same setting applies to “Phone” and “Video-phone” of the “Select ring tone”. →p.329 in [Application]
- When data or a file with the “FOMA card operational restriction function” (p.53) set is set to the ring tone, if you remove the FOMA card or replace it with another one, the ring tone setting is reset to the default setting (The settings will not change, so if you put the FOMA card back in, your set ring tone will play again).
- The ring volume that sounds during ring tone selection for calls or mail/messages is the same volume as set in the “Ring volume” (p.79) for “Phone/Video-phone” or “Mail/Message”. If the “Ring volume” is set to “Silent”, no ring tone sounds.
- The play part may have already been specified in the melodies with “ $\underline{\text{A}}$ ” or “ $\underline{\text{B}}$ ”. If it is set to a ring tone, etc. only the specified part will be played.
- The i-motion unavailable for a ring tone is grayed out.
- If you set i-motion having an image and sound to the ring tone, an image set in “Display setting” is not displayed but the i-motion image is displayed.
- The ring tone for voice calls with no caller ID, you can set it in the “Call setting w/o ID” (p.145). The ring tone for the videophone call with no caller ID is subject to the “Video-phone” setting of this function.
- When the functions of the mail ring tone are set at the same time, they are prioritized as follows. ① has the highest priority.
 - ① The mail ring tone of the Utilities
 - ② The mail ring tone of the Group Utilities
 - ③ The mail ring tone of the Select ring tone
- When you set i-motion such as the pre-installed movie ringtone to the ring tone of “Phone”, “Ring tone 1” will be emitted during 64k data communication.

Using Vibration to Notify You Incoming Calls and Mail

Default setting OFF

You can set each vibration pattern for incoming voice calls, videophone calls, mails, Msg. Request and Msg. Free.

- When the manner mode is set to “Original” and the vibrator in the “Original” is set to “OFF”, the FOMA terminal does not vibrate.

1 Select   “Incoming call”  “Vibrator”.

2 Select the item for which you want to set the vibrator.



3 Select the vibration pattern.

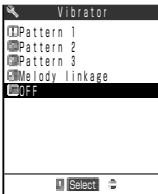

Highlight the vibration pattern. The FOMA terminal vibrates in the highlighted pattern.

Pattern 1 to 3 : The FOMA terminal vibrates in a specific pattern.

Melody linkage : The FOMA terminal vibrates in accordance with the pattern of the melody set to the ring tone.

However, if no vibration pattern is set to the melody or i-motion is set to the ring tone, the terminal vibrates in Pattern 2.

OFF : The FOMA terminal does not vibrate.

The icon at the standby display indicates the items where the vibrator is set.

 : Indicates that the vibrator is set to a voice call and video-phone.

 : Indicates that the vibrator is set to mail.

 : Indicates that the vibrator is set to a voice call, video-phone and mail.

Vibrator settings for Msg. Request/Free cannot be confirmed with icons.

NOTE

- When “Mail/Msg. ring time” (p.240 in 『Application』) is set to “OFF”, no “V” appears and the FOMA terminal does not vibrate for incoming Msg. Request/Free.
- When the sound effect of the flash image emits, even if the vibrator is set, the FOMA terminal does not vibrate.
- If you have set the vibrator to ON, be careful that the FOMA terminal will not approach fire (e.g. a heater) or fall from a desk due to vibration for incoming calls.



Keypad sound

Turning Off the Keypad Sound

Default setting ON

You can mute the keypad sound when the key is pressed to avoid disturbing other people around you.

- When the Keypad sound function is set to “OFF”, the following tones will not sound:
 - Various alarm tones
 - Battery level indication tone
 - Volume adjustment startup tone
 - Snooze cancel tone for Alarm clock
- Regardless of this function setting, the following operations play the keypad sound:
 - When you press [Memo/Check] with the FOMA terminal folded
 - When you take a picture/movie with the camera
 - When the low-battery alarm sounds
 - When the messages are played/ended (through the earpiece speaker)
 - When you start/stop recording a voice memo during standby (through the earpiece speaker)
 - When you start/stop recording your message with the Voice announce function (through the earpiece speaker)
- The volume of the Keypad sound will not change, regardless of the settings made at “Ring volume”.

1 Select   “Other settings” ▶ “Keypad sound”.

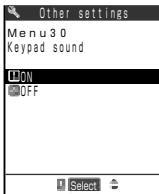

To sound the keypad sound
Select “ON”.

To turn the keypad sound off
Select “OFF”.

Setting the FOMA Terminal to Emit the Charge Sound

Default setting | ON

To avoid leaving the FOMA terminal with the power charged, you can set it to emit the charge sound “pippi” when charging starts and ends.

- Regardless of this function setting, the FOMA terminal does not emit the charge sound during the following situations:
 - When a screen other than the standby display is displayed
 - While the driving mode is set
 - While the manner mode is set
 - When the power is off
 - While the “Phone/Video-phone” in “Ring volume” is set to “Silent”

1 Select   “Other settings” ▶ “Charge sound”.

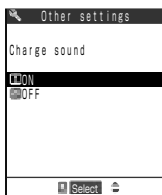

To emit the charge sound

Select “ON”.

To turn the charge sound off

Select “OFF”.

Using the Desktop Icons

You can paste a phone number or function frequently used as a desktop icon on the standby display. The desktop icons allow you to display a phone number or call up a function with a quick operation.

- The icons you can paste on the desktop are as follows:
 - Phone number, Mail address, URL, Melody, Image, Movie, i-motion, Chara-den and i-appli software
 - Camera, ToDo list screen, Access reader, Bar code reader, Dictionary and each function in the Original menu
- You can paste up to 15 desktop icons.
- You cannot paste a melody or image pre-installed in the FOMA terminal or an original animation on the desktop.

Pasting desktop icons

<Example: Pasting phone numbers in the phonebook>

1 Display the phone number you want to set.

How to search the phonebook →p.116

When multiple phone numbers are stored in a single phonebook

Press  to display the desired phone number.

When pasting a phone number from the “Received calls”, “Dialled calls” or “Redial”

Highlight the phone number you want to display on the list screen or display the detailed screen.

2 Select “Add desktop icon” from the function menu.

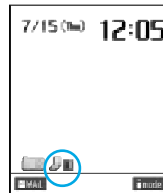

NOTE

- You cannot paste a phone number from a phonebook which is stored as a secret data.
- You cannot paste a phone number, mail address, URL, image, movie or i-motion saved in the miniSD memory card as a desktop icon.
- During “PIM lock”, you cannot check the details of a desktop icon, edit a title, delete a desktop icon or reset a desktop.

Pasting other desktop icons

Mail address

To paste the mail address in the phonebook

Display the details screen of the mail address you want to paste.

To paste the received mail sender or sent mail destination

Display the mail details screen of the received mail sender or sent mail destination you want to paste.

The sender's address with " [] " cannot be pasted.

To paste the mail address in the received address list or sent address list

Highlight the mail address you want to paste on the list screen.

SMS address (phone number)

To paste the received SMS sender or sent SMS destination

Display the mail details screen of the received mail sender or sent mail destination you want to paste.

To paste the SMS address in the received address list or sent address list

Highlight the SMS address you want to paste on the list screen.

SMS address cannot be pasted from a phonebook.

URL

To paste a URL of a site

Display the URL you want to paste.

To paste a bookmark URL

Highlight the title you want to paste on the bookmark list screen.

To paste a URL in the URL history

Highlight the URL you want to paste on the URL history screen.

Up to 256 characters can be pasted for one URL.

If the URL of a site that contains images or melodies is pasted, it may not be possible to display this site from the desktop icon.

➔ Select "Add desktop icon" from the function menu.

Data of melody, image, movie, i-motion and Chara-den

Highlight the melody you want to paste on the "Melody player" list screen.

Highlight the image you want to paste on the "Image viewer" list screen.

Highlight the movie or i-motion you want to paste on the "Movie player" list screen.

Highlight the Chara-den you want to paste on the "Chara-den player" list screen.

i-αppli software

Highlight the software you want to paste on the software list screen.

"Camera" function

Display the camera menu screen.

"ToDo" list

Display the "ToDo" list screen.

"Access reader" function

Display the "Access reader" list screen or details screen.

"Bar code reader" function

Display the "Bar code reader" list screen.















"Dictionary" function

Display the "Dictionary" screen.

"Original menu"

Display the "Original menu" addition screen.

Title of pasted desktop icons

Icon displayed	Type	Title
	Phone number	Name stored in phonebook (if not, phone number)
	Mail address	Name stored in phonebook (if not, mail address)
	SMS address	Name stored in phonebook (if not, phone number)
	URL	Page title (if not, URL without "http://" or "https://" is displayed)
	Melody	Melody title (if not, "Melody")
	Image	Image file name (if not, "Image")
	Movie or i-motion	Movie or i-motion title (if not, "i-motion")
	Chara-den	Chara-den title (if not, "Chara-den")
	i-appli software	Software name
	Camera	Each function name
	ToDo	
	Access reader	
	Bar-code reader	
	Dictionary	
	Original menu	

※ : When a desktop icon is selected, the first 11 full-pitch or 22 half-pitch characters will be displayed for the title.

Calling up the data or function from desktop icons



1 Press  while the standby display is displayed.

2 Position the cursor over the desktop icon you want to use.



















The desktop icon title at the cursor point is displayed.

If there are more than 6 desktop icons stored

You will see " 

 on both sides of the display. Press  to scroll across the desktop icons.

3 Press [Select].

-  : The pasted phone number is displayed in the dial screen. Press  or  to make a voice call or videophone call.
-  : The New mail composing screen is displayed with the pasted mail address entered. →p.154 in 『Application』
-  : The New SMS composing screen is displayed with the pasted SMS address (phone number) entered. →p.198 in 『Application』
-  : The page is displayed by connecting to that pasted URL site. →p.42 in 『Application』
-  : The pasted melody is played with the “Melody player”. →p.341 in 『Application』
-  : The pasted image is displayed with the “Image viewer”. →p.302 in 『Application』
-  : The pasted movie or i-motion is played with the “Movie player”. →p.316 in 『Application』
-  : The pasted Chara-den is played with the “Chara-den player”. →p.333 in 『Application』
-  : The pasted i-αappli software started. →p.73 in 『Application』
-  : The “Camera” is started. →p.254 in 『Application』
-  : The “ToDo” list screen is displayed. →p.228
-  : The “Access reader” is started. →p.284 in 『Application』
-  : The “Bar-code reader” is started. →p.289 in 『Application』
-  : The “Dictionary” is started. →p.237
-  : The “Original menu” is displayed. →p.244

NOTE

- When “PIM Lock” is on, you will see no desktop icon for phone number, mail addresses, SMS addresses, URLs, melodies, images, movies or i-motions, Chara-dens, or i-αapplis. Cancel “PIM lock” to bring them back.
- The pasted data can only be played or displayed from the melody, image, movie, i-motion, Chara-den or i-αappli desktop icons.
- If you paste data, such as a melody or image, as a desktop icon and delete the original data, you cannot also call it up from the desktop icon.

Checking the information of a desktop icon

You can check information such as the detail and title you have pasted on the desktop icons.

1 Select  ►  ► “Display” ► “Desktop icon”.

2 Select the desktop icon title you want to check.

NOTE

- On the desktop icon details screen, press  to scroll the screen and check all the URL.

Changing the title of a desktop icon

You can change the title you have pasted on the desktop icons.

- Your title can be up to 16 full-pitch or 32 half-pitch characters. However, the title that will be displayed when you select the desktop icon will only be up to the first 11 full-pitch characters or 22 half-pitch characters.

1 Select  ►  ► “Display” ► “Desktop icon”.

2 Highlight the title you want to change and select “Edit title” from the function menu.



3 Change the title.

Entering characters → p.300

NOTE

- Even if the desktop icon title is changed, the title of the pasted original data remains unchanged. Moreover, even if the original data title is changed, the desktop icon title remains unchanged.

Deleting a desktop icon pasted on the standby screen

1 Select   “Display” ▶ “Desktop icon”.

2 Highlight the desktop icon you want to delete and select “Delete this” from the function menu.

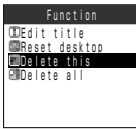

When you want to delete all
Select “Delete all”.

Resetting the desktop icons to the default setting <Reset desktop>

You can delete all the desktop icons other than the camera desktop icon, which is included at the time of purchase.

1 Select   “Display” ▶ “Desktop icon”.









2 Select “Reset desktop” from the function menu.













Information notified by the desktop icons

A desktop icon appears to notify you of information such as an incoming new mail.

You can make an access to the related function with the same operation as a pasted desktop icon.

Icon	Information	What is displayed/started after operation	See page
	Notifies you that there is a new mail.	The received mail list screen in the Inbox containing the latest mail will appear.	p.182 in 『Application』
	Notifies you that there is a missed call.	The “Missed calls” will appear.	p.151
	Notifies you that there is a recorded message.	The “Play/Erase msg.” will be started.	p.247
	Notifies you that there is a voice mail stored in the voice mail service center.	The “Voice mail” will be started.	p.273
	Notifies you that there is a missed alarm of Alarm clock, Schedule or ToDo.	The latest missed alarm information will appear.	p.212
	Notifies you that an i-αppli software could not automatically startup.	The Auto start info screen will appear.	p.81 in 『Application』
	Notifies you that i-αppli standby screen was abnormally ended.	The Security error record will appear.	p.91 in 『Application』
	Notifies you that the “Software update” has completed.	After entering the PIN code, the update result display screen will appear.	p.375

NOTE

- Even when the “” is not displayed, you may have some messages left in the Voice Mail Service Center.
- Selecting “” displays the “Missed calls” record and an icon shows whether it was a voice call or a videophone call that you missed.
For details about the icons displayed in the missed calls record. →p.153
- When the “PIM lock” is set while “”, “”, “”, “”, “”, “” are displayed, these desktop icons disappear, but the icons will reappear after canceling the “PIM lock”.
If you receive a mail during PIM lock, “” will appear after canceling the PIM lock.
- To delete a desktop icon notifying information, hold down  for 1 second or more. (This clears only the icon but the contents are not deleted.)
- The desktop icons notifying information are not deleted even though the power is turned off, but deleted when the battery pack is removed.
- If you access from each desktop icon to each function or from the menu to each function, the desktop icon disappears. However, “” do not appear unless the record message is played or erased.

Displaying Your Favorite Image on the Screen

Default setting Stand-by display: Aqua Wake-up display: Tropical Fish
 Dialing : Standard Calling: Standard Mail sending: Standard
 Mail receiving: Standard Checking: Standard

You can set your favorite image such as a photographed still image or downloaded image on the display.

You can set an image as follows:

Item (Display)	What can be stored
Stand-by display	Set a calendar or image* to be displayed on the standby display. You can also set a movie, i-motion or i-appli standby display, or set no image (OFF).
Wake-up display	Set a message or image* to be displayed when the power is turned on. You can also set no message/image (OFF).
Dialing	Set an image* to be displayed when you make a voice call/videophone.
Calling	Set an image* to be displayed when you receive a voice call/videophone.
Mail sending	Set an image* to be displayed when you send a mail.
Mail receiving	Set an image* to be displayed when you receive a mail or Msg. Request/Free.
Checking	Sets an image* to be displayed when you perform the Check messages (p.276), the Check new message or the Check new SMS (p.106, p.184 and p.202 in [Application]).

* : In addition to a still image, an animation and an original animation are also available.

- Images, movies and i-motions stored in a miniSD memory card cannot be set in this function.

Setting the display for the standby display

- You cannot select a "Calendar" when the date and time is not set in "Set time".

1 Select   "Display" ► "Display setting".

2 Select "Stand-by display".



3 Select the item you want to set.



To display no image

Select "OFF".

To display a calendar

Select "Calendar".

Select "Background"/"No background".

When you set to "Background", select a background image.

How to select an image → p.302 in 『Application』

To display an image

Select "Image" and select an image.

How to select an image → p.302 in 『Application』

To display a movie or i-motion

Select "i-motion" and select a movie or i-motion.

Some i-motion may not be available for the display.

How to select a movie/i-motion → p.316 in 『Application』

To set the i-appli standby display

Select "i-appli display" and select software.

When "i-appli" is set, "★" appears.

For the details of "i-appli display" → p.86 in 『Application』

When the calendar is set to the standby display

The calendar appears on the standby display. You can check the previous or next month calendar or set your schedule with a quick operation.

To check the previous or next month calendar

While the standby display is displayed, press [Select] or slide to have the pointer on a calendar so that you can select the calendar. Press [Select] again or select the calendar with the pointer. Then press to display the previous month calendar or to display the next month calendar.







When a "Desktop icon" has been pasted on the standby display, pressing [Select] selects the Desktop icon or calendar used last. If the Desktop icon is selected, select the calendar. And Press [Select] again or select the calendar with the pointer. Then press or to display the previous or next month calendar.

When you want to start up Schedule function.

Select a calendar and press [Select] to start the Schedule function, so that you can enter the schedules for the displayed month.

Public holidays are based on the "国民の祝日に関する法律及び老人福祉法の一部を改正する法律(平成13年法律第59号) (Law Partially Revising the National Holidays Law and Old-Age Welfare Law)". (As of June, 2004)

NOTE

- When a Pre-installed animation or an animation stored in the Image is set and the FOMA terminal is opened, the first frame of the animation appears as the standby display. However, in case of SWF*, pressing either  or  stops playing the animation and the stopped animation is displayed as a standby display.
※ : SWF is a file format of Flash image. →p.46 in 『Application』
- If a movie and i-motion is your standby display, that movie or i-motion will be played when you open your FOMA terminal. Press  or  to stop playing the movie or i-motion. Also, when the terminal is set to the manner mode, you will only see the image. Icons displayed in the second row of the standby display such as “”, “” or “”, clock or desktop icons are not displayed while you play the movie or i-motion.
- You cannot use the “Phone To function”, “Mail To function” and “Web To function” (p.113, p.114 and p.115 in 『Application』) from the i-motion standby display.
- When “Automatic display” (p.125) is set, the setting of “Automatic display” is given priority over this function. Opening the FOMA terminal displays no image.
- The setting of “i-appli standby display” (p.86 in 『Application』) is given priority over this function setting if the “i-appli standby display” is set.

Setting the display for the Wake-up display

1 Select   “Display”  “Display setting”.

2 Select “Wake-up display”.

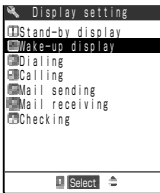

3 Select the item you want to set.



To display no image

Select “OFF”.

To display a message

Select “Message” and enter a message.

Up to 50 full-pitch or 100 half-pitch characters can be entered.

Entering characters →p.300

To display an image

Select “Image” and select an image.

How to select an image →p.302 in 『Application』

Setting an image for incoming/outgoing calls or mail

1 Select   “Display” ▶ “Display setting”.

2 Select the item for which you want to set an image.



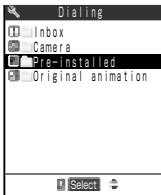

- Dialing : It will set the image displayed when you make a voice call/videophone.
- Calling : It will set the image displayed when you receive a voice call/videophone.
- Mail sending : It will set the image displayed when you send an i-mode mail or SMS.
- Mail receiving : It will set the image displayed when you receive an i-mode mail, SMS, Msg. Request/Free.
- Checking : It will set the image displayed when you make inquiries to the service or check i-mode or SMS.

3 Select the item you want to set.



If there are your original folders, you can select an image from them.
How to select an image →p.302 in 『Application』

To check the image

- Highlight the item to be checked and press  [Play].
- Press  to return to the list screen of image data.

NOTE

- If the Called settings confront with each other, the priority of the image displays is as follows. ① has the highest priority. However, if an i-motion operates as a ring tone, the i-motion will appear.
 - ① i-motion set in the phonebook registration image
 - ② The incoming call image of the Utilities
 - ③ The incoming call image of the Group Utilities
 - ④ The image of the phonebook registration image
 - ⑤ The screen display settings

Display phonebook image

Setting the Display of Images Stored in the Phonebook

Default setting ON

When you receive a voice call or videophone call from a telephone number registered with a still image or movie, you can set whether or not to display the image.

1 Select   “Incoming call” ▶ “Disp. phonebook image”.



To display the image stored in the Phonebook
Select “ON”.

To display the image set in “Display setting”
Select “OFF”.

NOTE

- If the Called settings confront with each other, the priority of the image displays are as follows. ① has the highest priority. However, if an i-motion operates as a ring tone, the i-motion will appear.
 - ① i-motion set in the phonebook registration image
 - ② The incoming call image of the Utilities
 - ③ The incoming call image of the Group Utilities
 - ④ The image of the phonebook registration image
 - ⑤ The screen display settings
- Regardless of the settings made in this function, you will not see any images on the secret data (p.201) phonebook.

Viewer settings

Setting the Image Viewer Display

Default setting Picture

When displaying the still images stored in the “Image viewer”, you can either display them by picture (thumbnails) or by title (file names).

Four images per screen appear in the picture display (thumbnails).

- Original animation cannot be displayed by pictures (thumbnails).
- For more information about operating the “Image viewer”, see p.302 in 『Application』.

1 Select “Display” ▶ “Viewer settings”.



When listing by picture (thumbnails)

Select “Picture”.

When listing by title (file name)

Select “Title”.

Color pattern

Changing the Display Color

Default setting | Pattern 1

You can select the display color pattern such as characters and background.

1 Select “Display” ▶ “Color pattern”.

2 Select a color pattern.

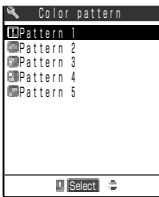

While selecting a color pattern, the display color pattern changes to the selected color pattern.

NOTE

- Icons and images will not change even if this setting is changed. In addition, there are some data or functions, such as i-motion site screen, which have color pattern that will not change even if this setting is changed.

Setting Whether to Turn On/Off the Display Light for the Display and Keys

Default setting **Lighting: ON+Saver (Light time: 5 minutes)** **Charging: Standard**
Area: LCD+Keys **Brightness: Level 2**

You can set how the display light for the display and keypad is turned on/off. You can set the following items:

Purpose	Item	Description	
Display light on/off setting	Lighting	ON	When the FOMA terminal is opened, the display light for the display and keypad* is ON for about 15 seconds.
		OFF	The display light for the display and keypad is OFF.
	Charging	Standard	The same setting as “ON” for “Lighting”.
		All time	When the FOMA terminal is opened, the display light for the display and keypad* is ON all the time.
Power saver mode setting	Power saver mode (Set from the “Lighting” setting)	ON	After the specified light time elapses, the standby display and the indicator display is turned off (Power saver mode).
		OFF	The power saver mode will not be activated.
Display light area setting	Area	LCD+Keys	The display light for the display and keypad is ON.
		LCD	The display light for the display is ON.
Display light brightness setting	Brightness	Selects from “Level 1” (dark), “Level 2” (normal) or “Level 3” (bright).	

※ : If the “Area” is set to “LCD”, the display light is OFF.

<Example: Setting the display light for the usual time>

1 Select   “Display” ▶ “Display light”.

2 Select “Lighting”.

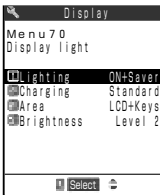

To set the display light during charging

Select “Charging”.
 Select the display light setting from “Standard”/“All time”.

To set the area where the display light is ON

Select “Area”.
 Select the display light area from “LCD+Keys”/“LCD”.

To set the brightness of the display light

Select “Brightness”.
 Select the brightness of the display light from “Level 1”, “Level 2” and “Level 3”.

3 Select the item to be set.

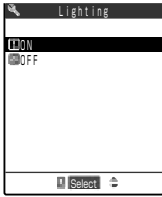

To turn the display light on

Select "ON".

Select the power saving mode from "Valid/Invalid" (ON/OFF).



If it is set to "ON", you set up the time shifting to the power saving mode in the range between 02 and 20 minutes.

If you do not want to turn the display light on

Select "OFF".

"" is displayed on the standby display.

NOTE

- During a videophone call, the "Display light" setting in the videophone is given priority.
- When the Power saver mode starts with the FOMA terminal opened, the display light for the display is turned off, and  and  flash at intervals of 5 seconds. Press keypad and the Power saver will be disabled.
- Even if you set "Charging" to "All time" and "Area" to "LCD+Keys" in charging during a videophone call, the display light for the keypad is turned off with no operation for about 15 seconds.
- If you do not operate any function for about 15 seconds even when recharging the battery with the setting of "All time ON" in "Charging", the display light for the display is turned on at "Level 1" to increase the recharging efficiency.
- Hold down  for 1 second or more to turn on/off the display light. However, you cannot switch on/off during character entry, videophone call, remote monitoring or i-αppli. If you perform these operations during charging, the "Charging" setting in Display light setting will not be changed.
- The light works with the setting of "Lighting" when charge ends and the charging indicator disappears, even if "All time" is set for "Charging".
- The power saver mode is not activated when the standby display is displayed from the task menu while a menu function is running, or "i-αppli standby display" (p.86 in 『Application』) is set.

Setting the Incoming Call Lamp to Flash at Incoming Call

Default setting	Phone: Color 5 Video-phone: Color 5 Mail: Color 1 Msg. Request: Color 1 Msg. Free: Color 1 Set pattern: Standard Color name: Color 1 to 12
-----------------	--



You can set the flashing color and flashing pattern of the incoming call lamp that alerts you to incoming voice/videophone calls, mail or Msg. Request/Free. You can also change the flashing color name or adjust the color tone.

You can set the following items:

Item		Description
Set color	Phone	Select the flashing color ^{※1} of the incoming call lamp when receiving voice calls and 64K data communication.
	Video-phone	Select the flashing color ^{※1} of the incoming call lamp when receiving videophone calls.
	Mail	Select the flashing color ^{※1} of the incoming call lamp when receiving i-mode mail, SMS and packet communication.
	Msg. Request	Select the flashing color ^{※1} of the incoming call lamp when receiving Msg. Request.
	Msg. Free	Select the flashing color ^{※1} of the incoming call lamp when receiving Msg. Free.
Set pattern	Standard	Set the incoming call lamp to flash in fixed intervals.
	Melody linkage	Set the incoming call lamp to flash in accordance with the melody ^{※2} .
Adjust color	Edit color name	Change the color name for Color 1 to 12.
	Adjust color tone	Adjust the color tone for Color 1 to 12.

※1 : Select the flashing color from Color 1 to 12 or Gradation.

※2 : When no flashing pattern is set to the melody, or movie ring tone is set, the incoming call lamp flashes in "Standard".

- The flashing pattern of  and  is the same as that of the incoming call lamp, but their flashing color is orange only.
- You can set a flashing color for incoming calls or mail from each specified phone number, mail address or group. →p.120

1 Select   "Incoming call"  "Illumination".

2 Specify the setting for each item.

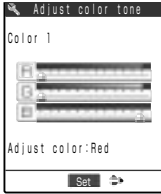

Set color:

Sets the flashing color of the incoming call lamp at incoming calls or mail.

Select the item which you want to set from “Phone”, “Video-phone”, “Mail”, “Msg. Request” and “Msg. Free”, and then set a flashing color. While selecting a flashing color, the incoming call lamp flashes in the selected color.

Set pattern:

Select the flashing pattern of the incoming call lamp from “Standard” and “Melody linkage”.

Adjust color:

Sets “Edit color name” and “Adjust color tone” for the incoming call illumination.

In “Edit color name”, select a color you want to change and enter a new color name.

Up to 10 full-pitch or 20 half-pitch characters can be entered.

Entering characters → p.300

In “Adjust color tone”, select a color you want to adjust and adjust its color tone. As the color types of Color 1 to 12 are different, they cannot be adjusted to the same color tone. The gradation cannot be adjusted.

NOTE

- When a voice message recorded with the “Voice announce” function is set to the ring tone, the incoming call lamp flashes in a fixed pattern regardless of this setting.
- When “Pattern 1”, “Pattern 2” or “Pattern 3” is set to the ring tone, the incoming call lamp flashes in accordance with the melody regardless of this setting.
- When remote monitoring is received, the flashing color is “Gradation” and the flashing pattern is “Standard” regardless of the settings of this function.
- When exchanging between a miniSD memory card and data, the light will flash in “Color 5”, regardless of the settings made here.
- During charging and shooting, the color and flashing color of the incoming call lamp is red regardless of the “Adjust color tone” setting.

Illumination in talk

Setting the Incoming Call Lamp to Flash During a Call

Default setting OFF

You can set the flashing color of the incoming call lamp during a voice or videophone call.

- You can select the flashing color from seven kinds of colors and three kinds of gradations.

1 Select   “Talk”  “Illumination in talk”.

2 Select the flashing color you want to set.



When you do not want to flash the lamp during the call
Select "OFF".

Setting the Way the Indicator Display is Displayed

Default setting	Setting: Display information Contrast: Level 5 Clock type: Digital Phone No.: ON Mail: OFF Connection: ON (Display light: OFF)
-----------------	--

You can set how a clock and messages are displayed in the Indicator display and adjust the LCD contrast.

1 Select "Display" ► "Indicator display".

2 Select how you want the display.

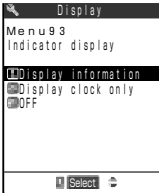

- Display information : It will display clock, message, and animation to the indicator display.
- Display clock only : It will only display clock on the indicator display. There will be no caller's number or animation displayed.
- OFF : It will display no indicator display at all. You cannot set any detail items at Step 3, if you set this to "OFF".

3

Specify the setting for each item.

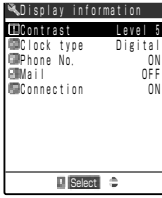





When Display information is selected

- Contrast** : Use  to adjust the LCD contrast from 9 levels: Level 1 (light) to 9 (deep).
While setting the contrast, the display contrast will change according to the level selected.
 - Clock type** : Select the type of clock among the 3 choices in analog and 1 in digital.
 - Phone No.**※ : Select whether or not to display the caller's number (or name if the number is registered in your Phonebook) when you receive a voice call by ON/OFF.
 - Mail**※ : Select whether or not to display the sender's mail address, subject, date and time received by ON/OFF.
 - Connection**※ : Select whether or not to display an image that indicates you are dialing a voice call/videophone call, using infrared communication or data communication by ON/OFF. If you set to "ON", you can select whether to turn the display light on by ON/OFF.
- ※ : This setting is only available when the display at Step 2 is set to "Display information".

NOTE

- When “Phone No.” is set to “ON”, the caller’s name (stored name) and the icon are displayed if the caller’s phone number is stored in the phonebook. When the caller does not notify his/her caller ID, the reason for no caller ID appears. If “Phone No.” is set to “OFF”, “Calling” is displayed.
- When you receive a new mail, “New message” appears. Depending on the “Mail” setting, the display changes as follows:
 - When the “Mail” is set to “ON”

Press  [Home] to display the sender’s mail address and subject. Press  [Home] again to return to standby display. Also, if the sender’s mail address is already registered in your Phonebook, you will see the sender’s name (registered on the Phonebook). If you receive multiple mails, you will see the mail address or name and subject of the three latest senders (p.41). However, you will not see any sender’s identity and subject if you received a mail from someone whose address is set in the “Auto sort address” (p.207 in 『Application』) to sort into a folder with “Security” (p.223 in 『Application』).
 - When “Mail” is set to “OFF”

Even if you press  [Home], “New message” remains to be displayed.
- The display “New message” will also disappear if you erase the  in desktop icon. If  [Home] is pressed when receiving a mail from the sender who has been stored in the phonebook as secret data in the “Secret mode” or “Secret only mode”, the sender (name), the subject and the received date and time are displayed. The sender (mail address) and the subject are displayed for the usual time.
- The time displays when you set “Clock type” to “Analog clock 1-3” are just examples.
- When “Display clock only” is set, messages such as “Missed call” or animations such as alarm notifications for the schedule or alarm clock are not displayed.
- When you set “ α illumination window” to “Software-dependent” and set i-appli that is compatible with illumination window display to the standby display, the software has the priority to display the illumination window.
- The display light ON/OFF setting for the indicator display is subject to the “Lighting” setting in “Display light”. While charging with the external power source such as an AC adapter, the display light setting for the indicator display is subject to the “Charging” setting in “Display light”.

Switching the Fonts

Default setting | Type: Font 1 Thickness: Medium

You can change character font displayed on the display or indicator display to your favorite font (typeface).

1 Select   “Display”  “Font”.

2 Select the item you want to set.



To select the font type

Select “Type”.

Select font type between “Font 1/Font 2”.

Example of Font 1:

あいうABC123

Example of Font 2:

あいうABC123

To set the font thickness

Select “Thickness”.

Select the font thickness from “Thin”, “Medium” and “Bold”.

NOTE

- Characters which can be switched to “Font 2” are alphabets (full- and half-pitch), numbers (full- and half-pitch), hiragana, katakana (full- and half-pitch), some symbols, Greek characters and Russian characters only. All other characters such as kanji are displayed in “Font 1”. The characters of entered phone number and clock display and others cannot be switched to “Font 2”.
- Characters are displayed in “Thin” on the screens such as the i-mode site screen, i-mode mail browse screen, editing screen, the detail screen of the Deco-mail, the characters of the indicator display, and the i-appli software screen regardless of the Font setting.

Setting the Clock Display

Default setting | Display: ON Size: Big

You can set the clock display and change the clock display size in the standby display. You can also set the standby display to display no date and no time.

1 Select   “Clock” ▶ “Clock display”.

2 Select the item you want to set.



To set the way the clock display is displayed
Select “Display”.

Select the display from “ON” and “OFF”.

To set the clock display size

Select “Size”.

Select the display size from “Big” and “Small”.

NOTE

- If “Display” is set to “OFF”, when “Alarm clock”, “Schedule” or “ToDo” is set, “🔔” and “📅” which appear in the standby display are not displayed.

Utilizing PIN Number

The FOMA terminal provides you with many convenient functions. To use some functions, you must enter the security code. Also, there is a NW security code and i-mode password that you will use in network services. Please set or activate them to suit your purpose to utilize the FOMA terminal.

- Note that if you forget any of these security codes, you will have to bring your FOMA terminal and your personal ID (e.g. your driver's license) to a DoCoMo service counter.
- To prevent unauthorized use by others, change these security codes (excluding the NW security code) to your desired numbers after purchase. Be sure to remember your new security codes by keeping a separate record.

Security code

A security code is a 4- to 8-digit security code that is required when setting a security function, deleting data, or resetting. You can change this code to the number of your choice using your FOMA terminal. →p.193

NW security code

A NW security code is a 4-digit security code that you have to enter when using some of the network services. You can set your own NW security code at the time of purchase. You cannot change your NW security code using your FOMA terminal or any other phone.

PIN <PIN1/PIN2 codes>

You can set PIN1 code and PIN2 code for the FOMA card.
For details of PIN1 code and PIN2 code, see p.194.



i-mode password

An i-mode password is a 4 digit password that you have to enter to register or delete sites from My menu, use message services, and to subscribe/cancel any paid i-mode services. Refer to 『Application』 for details. At the time of purchase, the i-mode password is set to "0000" (four zeros) by default. You can change this number to the number of your choice. In addition to your i-mode password, other information service providers may also require passwords of their own to use their services.

Changing Your Security Code

Default setting 0000 (four zeros)

To protect your important data stored in your FOMA terminal and enjoy your FOMA terminal more effectively, you can change your own security code (4- to 8-digit).

1 Select   “Lock/Security”  “Change security code”, and then enter the security code.

2 Enter a new 4- to 8-digit security code.



3 Select “YES”.

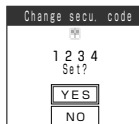

To cancel the security code change
Select “NO”.

Setting PIN Codes

Default setting PIN1 code: 0000 (four zeros)
 PIN2 code: 0000 (four zeros) PIN1 code entry set: OFF

The PIN1 code is a 4- to 8-digit number (code) to be entered each time when the FOMA terminal is turned on to prevent any unauthorized use of your FOMA card. The PIN2 code is a 4- to 8-digit security code to be entered when user authentication is required for online services such as accessing sites or the Internet. This FOMA terminal uses the PIN2 code when you perform the user certificate operation (issue of the user certificate to use FirstPass) and access sites compatible with FirstPass. →p.47 and p.49 in 『Application』

- When you purchase a new FOMA terminal, you can use the current PIN1 and PIN2 codes you have set.
- The PIN1 code and PIN2 code are stored in the FOMA card.
- If you fail to enter PIN1 code/PIN2 code for a total of 3 times, the PIN will automatically be locked, and you cannot use the PIN code anymore. Be sure to keep a separate record of your codes in case you forget them.
- Your copy of the FOMA subscription application form contains your PUK code. A PUK code is an 8 digit number to cancel the PIN lock when PIN1 code/PIN2 code is locked.
- If the PUK code is entered incorrectly 10 times in succession, the FOMA card will be locked completely. Keep your copy of the FOMA subscription application form in a safe place.
- If you forget your PUK code or your FOMA terminal is completely locked, contact a DoCoMo service counter.

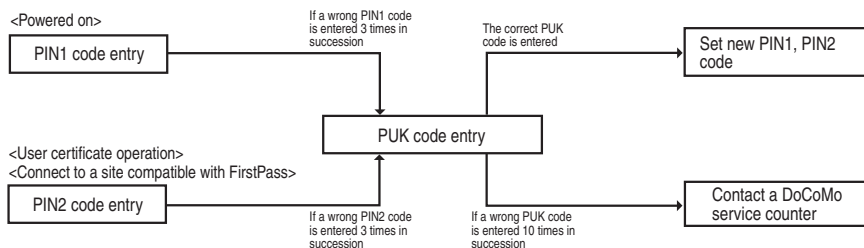

Setting the PIN1 code entry when the power is turned on <PIN1 code entry set>

To prevent any unauthorized use of your FOMA card, set the FOMA terminal to prompt to enter the PIN1 code when the power is turned on.

1 Select   “Lock/Security” ▶ “PIN setting”, and then enter the security code.

2 Select “PIN1 code entry set”.



3 Select the item you want to set.



To enter PIN1 code when the terminal is turned on
Select “ON”.

Not to enter PIN1 code when the terminal is turned on
Select “OFF”.

Changing the PIN1/PIN2 code

● To change the PIN1 code, “PIN1 code entry set” must be set to “ON”.

<Example: Changing the PIN1 code number>

1 Select   “Lock/Security”  “PIN setting” and enter security code.

2 Select “Change PIN1 code”, and enter your current 4- to 8-digit PIN1 code.



To change the PIN2 code

Select “Change PIN2 code”, and enter your current 4- to 8-digit PIN2 code.

3 Enter a new 4- to 8-digit PIN1 code.

To change the PIN2 code
Enter a new 4- to 8-digit PIN2 code.

4 Enter the new PIN1 code again.

To change the PIN2 code
Enter the new PIN2 code again.

Entering the PIN1 Code When the Power is Turned On

When “PIN1 code entry set” is set to “ON”, turning on the power displays the PIN1 code entry screen. Enter your PIN1 code.

- Note that if you do not enter the PIN1 code and leave the entry screen displayed, you cannot use the FOMA terminal and the following operation is not available.
 - Incoming voice and videophone calls
 - Alarm notification for “Schedule” or “ToDo”
 - Receiving mail and Msg. Request/Free
 - Activating i-appli software automatically
 - Reserved update of software

1 Turn the FOMA terminal on.

2 Enter your 4- to 8-digit PIN1 code.



When the correct PIN1 code is entered, the standby display appears.

Canceling PIN Lock

If you enter a wrong PIN1/PIN2 code three times in the PIN1/PIN2 code entry screen, the PIN1/PIN2 code will be locked. In this case, cancel the PIN1/PIN2 code lock, and then set a new PIN1/PIN2 code.

- For the PUK code, check with (your copy of) the FOMA subscription application form supplied to you when you subscribe to the FOMA service.

<Example: Canceling the PIN1 code lock>

1 Enter the 8-digit PUK code.



2 Enter a new 4- to 8-digit PIN1 code.

To cancel the PIN2 code lock
Enter a new 4- to 8-digit PIN2 code.

3 Enter the new PIN1 code again.

To cancel the PIN2 code lock
Enter the new PIN2 code again.

About Lock Function

The FOMA terminal has the lock function to prevent other people from using it without permission or viewing your phonebook and mail. The functions you can set are as follows.

Purpose	Description	Function	See page
To prevent other people from using the FOMA terminal	Disables all operations except for turning the power ON/OFF and receiving the remote monitoring.	All lock	p.200
To prevent other people from viewing data such as "Phonebook" and "Schedule"	Stores data such as "Phonebook" and "Schedule" as secret data that cannot be called up unless the "Secret mode" or "Secret only mode" is set and calls up such data (The "Secret only mode" calls up secret data only.).	Secret mode/Secret only mode	p.201
To prevent other people from seeing or rewriting your private information	Disables the display and editing of private information such as "Phonebook", "Schedule" and "Mail". The "i-mode" and "i-αppli" software start-up are also disabled.	PIM lock	p.204
To prevent personal calls from being made	Disables call making and mail sending by dialing. Only phone numbers and mail addresses stored in the phonebook, Dialed calls and Sent address are available.	Keypad dial lock	p.205
To prevent other people from seeing the dialed/received call records	Disables the display of "Received calls", "Dialed calls" and "Redial".	Record display set	p.206
To use the FOMA terminal without being concerned about an incoming voice or videophone call	Disables voice/videophone call dialing/receiving, i-mode connection and mail transmission.	Self mode	p.207
To prevent unintentional key operation	Disables the side key functions.	Side keys guard	p.208

Preventing Other People from Using Your FOMA Terminal

Default setting | Canceled

When the All lock is set, all operations except for turning the power ON/OFF are unavailable. This function prevents other people from using your FOMA terminal without permission.

- During the All lock, you cannot make and receive voice/videophone calls.
- Turning the FOMA terminal off does not cancel the All lock.

Setting the All lock

- 1 Select   “Lock/Security” ▶ “All lock”, and then enter the security code.

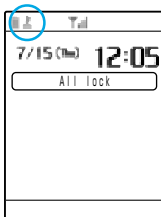



When the All lock is set, “All lock” and “” are displayed.
Security code →p.192

Canceling the All lock

- If you fail to cancel the All lock 5 times in succession, your FOMA terminal is turned off. However, you can turn it on again.

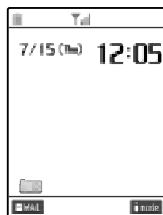
- 1 Enter the security code in the security code entry screen during the All lock and press .



The All lock is canceled and “” disappears.
Security code →p.192

NOTE

- During the All lock, you cannot make even an emergency call (e.g. 110, 119, and 118).
- If you set an animation for the standby display, only the first frame of the animation appears when the FOMA terminal is opened during the All lock.
- During the All lock, no ring tone sounds for incoming voice/videophone calls. After canceling the All lock, the “Missed call” desktop icon appears on the standby display.
- “Remote monitor” is available even when All lock is on.
- When All lock is on, you will receive no alarm notification even if you set them in “Alarm clock”, “Schedule” or “ToDo”. After you cancel All lock, you will see the desktop icon “Missed alarm” on the standby display.
- When the All lock is on, you can receive automatically the Msg. Request/Free, i-mode mails and SMS, but you will not see receiving display and the receiving result. Cancel the All lock and you will see the icon that indicates the type of message you have received.

Secret mode/Secret only mode

Preventing Other People from Seeing Your Phonebook and Schedule

Default setting | Secret mode: Canceled | Secret only mode: Canceled

You can store data such as data in the “Phonebook” and “Schedule” that you do not want other to know as secret data, which cannot be called up without entering the security code. To make secret data, register “Phonebook” or “Schedule” in Secret mode or Secret only mode.



In Secret mode, you can call up all data in “Phonebook” or “Schedule” including secret data. In Secret only mode, you can only call up secret “Phonebook” or “Schedule” data.

- If you perform operations for setting the Secret mode or Secret only mode during the Secret mode or Secret only mode, the current mode is canceled.
- If you make or receive a voice/videophone call during the Secret mode or Secret only mode, the current mode is canceled.
- You cannot store phonebook entries as secret data in the FOMA card.
- The Secret mode or Secret only mode is canceled when the terminal power is turned off.



Storing data in the phonebook and Schedule as secret data

- The operation method for the “Phonebook” and “Schedule” in the Secret mode and Secret only mode set is the same as that without the Secret mode and Secret only mode set.

<Example: Storing data in the Secret mode>

- 1** Select   “Lock/Security”  “Secret mode”, and then enter the security code.



When the Secret mode is set,  appears. If “Keypad dial lock” is already set,  appears.
Security code →p.192

To cancel the Secret mode

Press .

The secret mode is canceled and  disappears.

2 Store data in “Phonebook” or “Schedule”.



The data is stored as secret data.

How to store entries in Phonebook →p.108



How to store entries in Schedule →p.218

NOTE

- When the “Phonebook” or “Schedule” is called up in the Secret mode,  flashes for secret data.
- “Phonebook” and “schedule” entries stored as secret data cannot be called up, corrected or deleted unless you set the FOMA terminal to the secret mode or Secret only mode. For the “schedule”, alarm notification is given in the normal mode but no alarm message appears.
- If you store phonebook entries in the memory number “000” to “009” as secret data, you cannot dial these numbers by using the “Two-touch dialing” unless the Secret mode or Secret only mode is set.
- When the caller whose phone number and name are stored in the phonebook as secret data makes a call with his/her caller ID informed, the stored name is not displayed even during the Secret mode or Secret only mode. In addition, the caller’s phone number is recorded in the “Received calls”, but his/her stored name is not recorded.
- The following functions cannot be set for Phonebook entries stored as secret data:
 - Automatic display →p.125
 - Restrictions →p.141
 - Utilities →p.120
- When you modify “Phonebook” or “Schedule” in Secret mode, the modified data becomes a secret data. Moreover, if you modify even 1 phone number or mail address, all the rest of the numbers and addresses stored in the modified memory number will become secret data.
- When a phonebook entry with the “Utilities” function set is stored as secret data, the “Utilities” setting for the entry is canceled.
- When a phonebook entry with the “Utilities” set is stored as secret data, the “Utilities” setting becomes invalid. If you change the Phonebook entry stored as secret data to the normal “phonebook” entry, the “Utilities” setting becomes valid.

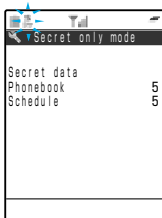
- 1 Select   “Lock/Security” ► “Secret only mode”, and then enter the security code.



When the Secret only mode is set, “” flashes and the number of secret data is displayed. If “Keypad dial lock” is already set, “” flashes.

After a few seconds the standby display will reappear.

Security code →p.192

To cancel the Secret only mode

Press .

The secret only mode is canceled and “” disappears.

- 2 Search the phonebook or check the schedule.

How to search the phonebook →p.116

How to check the schedule →p.222

NOTE

- If you make a call by calling up secret data, the call is not recorded in the “Dialled calls” and “Redial”.

Changing secret data to normal data

You can change data stored as secret data to normal data.

- 1 Call up a phonebook entry or schedule you want to delete in the Secret mode or Secret only mode.

How to search the Phonebook →p.116

How to check the Schedule →p.222

- 2 Select “Release secret” from the function menu.



In case of Phonebook

The secret is canceled. During the Secret mode, “” stops flashing and changes lighting.

Restricting Private Information Operations



Default setting Canceled

To prevent other people from seeing or rewriting your private information, you can lock the functions such as “Phonebook”, “Schedule” and “Mail”.

- You cannot use “Utilities”, “Restrictions”, name display for incoming/outgoing voice/ videophone calls and “Automatic display” set to phonebook entries.
- When the PIM lock is set, “Received calls”, “Dialled calls”, “Redial”, “Received address” and “Sent address” up until the entry are all deleted. Phone numbers/mail addresses recorded after this function is set, however, the caller/sender’s name does not appear even if he/she is stored in the phonebook.
- Turning the FOMA terminal off does not cancel the PIM lock.

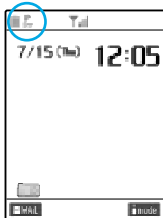
1 Select   “Lock/Security”  “PIM lock”, and then enter the security code.



When the PIM lock is set, “” appears. If “Keypad dial lock” is already set, “” appears.
Security code →p.192

To cancel the PIM lock

Perform the same procedure as the setting during the PIM lock.
The PIM lock is canceled and “” disappears.

NOTE

- If you perform a prohibited operation during the PIM lock, a message indicating that the PIM lock is being set appears.
- When the FOMA terminal is connected to an external device such as a PC, the PIM lock setting may become invalid. To prevent other people from using the phonebook, store data in the “Secret mode” or “Secret only mode”. →p.201
- When the PIM lock is on, you will receive no alarm notification even if you set them in “Alarm clock”, “Schedule” and “ToDo”. After you cancel the PIM lock, you will see the desktop icon “Missed alarm” on the standby display.
- When the PIM lock is on, you can automatically receive the Msg. Request/Free, i-mode mails and SMS, but you will not see receiving display and the receiving result. Cancel PIM lock and you will see the icon that indicates the type of message you have received.
- When the PIM lock is on, you cannot display or play the movie/i-motion clip, melodies except pre-installed ones, images and chara-den. When you set the movie/i-motion clip, melodies except pre-installed ones and images to the ring tone or standby screen, or set PIM lock, these functions are activated with default setting.

Prohibiting a Call by Dialing

Default setting | Canceled



When this function is set, voice or videophone calls by dialing with the keypad are prohibited. Dialing from previously stored “Phonebook” entries before setting keypad dial lock and from “Dialed calls” or “Redial” entries after setting keypad dial lock is possible.

If the FOMA terminal is used for business, private use can be prevented by previously storing necessary phone numbers in the Phonebook and by setting this function.

- When the Keypad dial lock is on, voice/videophone call, i-mode mail and SMS composition from the following operations cannot be done.
 - Dialing · Received calls · Received address · Mail member
 - Desktop icons · Access reader · Bar code reader · Play the record message
- When the Keypad dial lock is on, the following operations cannot be done.
 - Storing/editing*/deleting Phonebook entries
 - ※: Depending on the i-αpli DX (p.66 in 『Application』), the names for group 01 to 19 in the phonebook can be changed.
 - Using “Phone To” or “Mail To” functions
 - Entering mail addresses using keypads
 - Replying to mail addresses that are not stored in you phonebook
 - The phonebook data transmission by “lr exchange” function
 - Copying and deleting the phonebook by “UIM operation”
 - Importing the phonebook from the miniSD memory card
- When “Keypad dial lock” is set existing, “Received calls”, “Dialed calls”, “Redial”, “Received address” and “Sent address” are all deleted. However, “Received calls”, “Dialed calls” and “Redial” for calls received/dialed and “Received address” and “Sent address” for mail received/sent after this function is set are recorded. For unsent mail stored with address and body entered, the address is deleted but the body is left. Unsent mail stored with the address only is deleted.
- Turning the FOMA terminal off does not cancel the Keypad dial lock.

1 Select “Lock/Security” “Keypad dial lock”, and then enter the security code.



The Keypad dial lock is set and “” appears. If the “Secret mode” or “Secret only mode” is already set, “” appears. If the “PIM lock” is already set, “” appears.
Security code →p.192

To cancel the Keypad dial lock

Perform the same procedure as described above for the Keypad dial lock.

The Keypad dial lock is canceled and “” disappears.

NOTE

- Even if the Keypad dial lock is set, you can make a voice call to emergency numbers (e.g. 110, 119, and 118) by dialing with the keypad.
- If you perform a prohibited operation during the Keypad dial lock, a message indicating that the Keypad dial lock is being set appears.
- The FOMA card inserted while setting the Keypad dial lock enables storing of phonebook entries when it is inserted into another FOMA terminal. Note that calls can be made from the other FOMA terminal to phone numbers not stored in the phonebook.

Record display set

Setting Dialed or Received Call Record not to be Displayed

Default setting	Received calls: ON Redial/Dialed calls: ON
-----------------	---

You can set your FOMA terminal not to display the “Received calls”, “Dialed calls”, “Redial”, “Received address” and “Sent address”. It is useful for preventing other people from viewing your dialed or received call records.

- Even after the FOMA terminal is set not to display record, the information of “Received calls”, “Dialed calls”, “Redial”, “Received address” and “Sent address” are recorded.
- The settings for the Record display set remain unchanged even if the terminal power is turned off.

1

Select   “Other settings” ▶ “Record display set”, and then enter the security code.

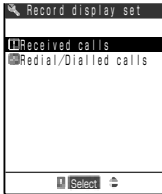

Security code →p.192

To set the display of “Received calls” or “Received address”

Select “Received calls”.

Select “display the Received calls/not display the received calls” (ON/OFF).

To set the display of “Redial”, “Dialed calls” or “Sent address”

Select “Redial/Dialed calls”.

Select “display the Redial/Dialed calls/not display the Redial/Dialed calls” (ON/OFF).

NOTE



- When “Received calls” is set to “OFF” and a call is missed, the “Missed call” desktop icon appears on the standby display. If you try to display “Received calls” from the “Missed call” desktop icon, a message indicating you that the “Received calls” is set to “OFF” appears. In this case, the desktop icon does not disappear. To delete the “Missed call” desktop icon, hold down  for 1 second or more.
- Even while the “Received calls” is set to “OFF”, “Record message” can be played.

Prohibiting Incoming/Outgoing Communication

Default setting | Canceled

You can set to disable voice/videophone call dialing/receiving, i-mode connection and mail transmission. It is useful for using your FOMA terminal without concerning about an incoming voice or videophone call.

- If a voice or videophone call comes in during the Self mode, the caller hears an announcement informing that you are out of the service area or the power is off. When you are using the “Voice mail” service (p.273) or “Call forwarding” service (p.278), you can use these services in the same manner as when the FOMA terminal is turned off.
- During the Self mode, no desktop icons such as “Missed call” appears.
- During the Self mode, data communication with the Ir exchange or an external device is not possible.
- Turning the FOMA terminal off does not cancel the Self mode.

1 Select   “Lock/Security” ▶ “Self mode”.

2 Select “YES” and then press  [Select].

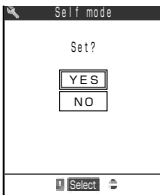

The Self mode will come on and you will see “self”.

Not to set the Self mode

Select “NO”.

To cancel the Self mode

Perform the same procedure as described above during the Self mode.

The self mode is canceled and “self” disappears.

NOTE

- Even if the “Self mode” is set, you can make a voice call to emergency numbers (e.g. 110, 119, and 118). The self mode is canceled when a voice call to an emergency number is made.
- If you perform a prohibited operation during the Self mode, a message indicating that the Self mode is being set appears.
- Msg. Request/Free and i-mode mail received during the Self mode are stored in the i-mode center, and SMS are stored in the SMS center instead. After canceling the Self mode, receive these Msg. Request/Free, i-mode mail and SMS stored in these centers by “Check new message” and “Check new SMS”. →p.106, p.184 and p.202 in 『Application』
- During the Self mode, some i-appli software that requires communications may not work.

Disabling the Side Keys While the FOMA Terminal is Folded

Default setting | ON when closed

The Side keys guard function is useful for preventing the side keys from being accidentally pressed when the FOMA terminal is folded and placed in your bag, etc..

- The side key functions will be enabled regardless of the settings made here in the following situations. However, you cannot activate the camera function by pressing [Memo/Check] more than 1 second :
 - When the FOMA terminal is open
 - When the earphone/microphone with switch (optional) is connected to the FOMA terminal
 - When an external device such as a PC is connected to the external connector and “” is displayed on the screen.
- The setting for Side keys guard remains unchanged even if the terminal power is turned off.

1 Select ► ► “Other settings” ► “Side keys guard” .



To enable the side key functions
Select “OFF”.

To disable the side key functions
Select “ON”.

“” appears on the standby display.

NOTE

- To switch between ON and OFF, press and hold down for 1 second or more.
- When this function is set to “ON”, you cannot check missed calls or new mail with your FOMA terminal folded even if the “Info notice setting” (p.77) is set to “ON”. In addition, you cannot check “Missed calls” (p.151) as well.
- Even if this function is set to “ON”, pressing the side key turns on the display light for the indicator display.
- When this function is set to “ON”, you cannot take pictures (still images) (using the shutter and light) with your FOMA terminal folded.

Using Alarm Notification

Default setting | Alarm preferred

You can specify whether the alarm notification of the “Alarm clock” (p.213), “Schedule” (p.216) and “ToDo” (p.228) are set to “Operation preferred” or “Alarm preferred”. If you set the alarm notification to “Operation preferred”, an alarm sounds only while the standby display is displayed. Select this setting if you do not want an alarm to sound while you are using the FOMA terminal. If you set the alarm notification to “Alarm preferred”, an alarm sounds even while you are using the FOMA terminal or talking. Select this setting if you want an alarm to sound at any time.

1 Select   “Clock” ▶ “Alarm setting”.

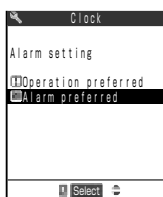

To give priority to operations
Select “Operation preferred”.

To give priority to alarm notification
Select “Alarm preferred”.

Alarm notification operations

When you set alarm notification for the “Alarm clock”, “Schedule”, and “ToDo”, an icon appears indicating that the alarm notification has been set on the standby display. At the specified time, an alarm sounds according to each function.

When you set alarm notification

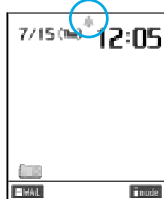

When you set alarm notification for the “Alarm clock”, “Schedule”, and “ToDo”, an icon appears on the standby display.

When an alarm is set for today (excluding alarms that have already been activated)

“” appears.

When an alarm is set for tomorrow or a later date

“” appears.

When the specified time is reached

The alarm notification is made for each function with the following operations:



Alarm clock



Schedule**





ToDo**

Status	Function	
	Alarm clock	Schedule/ToDo
While the standby display is displayed	If “Snooze setting” is set to “OFF”, an alarm tone sounds continuously for about 5 minutes. If “Snooze setting” is set to “ON”, an alarm tone sounds continuously for about 1 minute, repeating 6 times at intervals of about 5 minutes. An animation appears on the display and the indicator display.	An alarm tone sounds continuously for about 5 minutes, and an animation appears on the display and the indicator display.
When the power is off	No alarm notification is provided even at the specified time. If the FOMA terminal is past the specified time while being turned off, the setting is set to “OFF” when it has been set to be non-repeated (“No setting”), and the setting for tomorrow or a later date will be available when it has been set to be repeated (“Everyday” or “Specify”).	No alarm notification is provided even at the specified time, however the setting will be remained.
During a call	The clock alarm tone (pippipi...) sounds 3 times from the earpiece speaker. An animation appears on the display.	
When receiving/making a call	Alarm notification is provided in the same way as “during a call”. When receiving a call, alarm notification is provided in the same way as “during a call” as you answer the call.	
During i-mode/mail transmission	Alarm notification is provided in the same way as “while the standby display is displayed”.	
When operating Ir exchange or SD-PIM, or during data transmission with OBEX.	No alarm notification is provided even at the specified time. After the transmission is finished, “Missed alarm” desktop icon appears on the standby display. → p.212	
When the earphone/microphone is connected	An alarm tone sounds for about 20 seconds from the earphone. After about 20 seconds, an alarm tone sounds from both the earphone and speaker. An animation appears on the display and the indicator display.	
When “PIN1 code entry set” is set to “ON” and PIN1 code entry screen after turning on the power is displayed	Alarm notification is provided in the same way as “while the standby display is displayed”. If you clear the alarm notification display, the PIN1 code entry screen reappears.	Alarm notification is provided after you enter the correct PIN1 code.
During All lock/PIM lock	No alarm notification is provided even at the specified time. After canceling the All/PIM lock, “Missed alarm” desktop icon appears on the standby display (p.212). When the power is off during the All/PIM lock, the power is not turned on even at the specified time and the “Missed alarm” desktop icon does not appear even after canceling the All/PIM lock.	No alarm notification is provided even at the specified time. After canceling the All/PIM lock, “Missed alarm” desktop icon appears on the standby display. → p.212

** : Animations displayed at the alarm notification of “Schedule” and “ToDo” vary according to icons or categories set.

NOTE

- When the alarm notification settings for the “Alarm clock”, “Schedule” and “ToDo” are set to the same time, the priority is given as follows. ① has the top priority.
 - ① Alarm clock
 - ② ToDo
 - ③ Schedule

If alarm notification could not be provided, “” (Missed alarm) desktop icon appears on the standby display. When the power is off, “” (Missed alarm) desktop icon does not appear.
- At the alarm notification for “Schedule” entries stored as secret data, a secret animation appears with no alarm message. At the alarm notification when the “Secret mode” or “Secret only mode” is set, the stored message and animation appear. Regardless of whether the “Secret mode” or “Secret only mode” is set, the specified alarm tone sounds.
- The alarm tone for the “Schedule” and “ToDo” sounds at the volume set in the “Phone/Video-phone” of the “Ring volume” (p.79).
- During a call, the clock alarm tone sounds at the volume set in the “Volume”(p.78).
- During the manner mode, the alarm tone sounds at the volume set in the “Manner mode set”(p.136).
- If the “Vibrator” is set to other than “OFF”, an alarm tone sounds with vibration.

To stop an alarm tone**Alarm tone for Alarm clock****When “Snooze setting” is set to “OFF”**

If you press any key, the alarm tone stops and the animation changes to a still image. If you press any key again, two short cancellation tones “pipip” sound and the alarm notification display is cleared.

When “Snooze setting” is set to “ON”

If you press any key, the alarm tone stops, the animation changes to a still image, and the alarm message “Snooze···” appears. While “Snooze···” is displayed, the alarm notification is provided again after about 5 minutes. If you press  while “Snooze···” is displayed, two short cancellation tones “pipip” sound and the snooze function is canceled.

Alarm tone for Schedule and ToDo

If you press any key, the alarm tone stops, the animation changes to a still image, and the alarm message remains displayed. If you press any key again, the alarm message disappears. However, if you press the side key with the FOMA terminal folded, the alarm notification display remains displayed.

When you receive a call during alarm notification

The FOMA terminal stops the alarm notification and incoming call receiving starts. The snooze function for the “Alarm clock” is canceled.

NOTE

- If the “Keypad sound” (p.168) is set to “OFF”, no cancellation tone for the snooze notification sounds.

Checking the contents of alarm notification that could not be provided

When alarm notification could not be provided, “” (Missed alarm) desktop icon appears on the standby display. You can check the contents of the missed alarm (Missed alarm) from this desktop icon.

- The Missed alarm screen records the contents of the latest missed alarm for any of “Alarm clock”, “Schedule” or “ToDo”.

1 Press  on the standby display and select “”.



The missed alarm information for the “Alarm clock”, “Schedule” or “ToDo” appears.

To delete “” desktop icon

Hold down  for 1 second or more.

After “” desktop icon is deleted, you cannot check the missed alarm information.

2 After checking the contents, press .

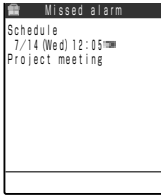

The standby display reappears and “” (Missed alarm) desktop icon disappears.

NOTE

- When the alarm settings for the “Alarm clock”, “Schedule” and “ToDo” are set to the same time and the alarm notification could not be provided, each missed alarm information appears.

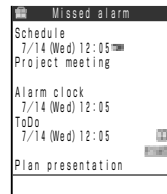

Using the Alarm Clock Function

Default setting | OFF

You can use your FOMA terminal as an alarm clock. At the set time, the FOMA terminal notifies you by emitting an alarm tone and displaying an animation. If the power is off, the FOMA terminal is not automatically turned on or the time is not notified even when the set time comes.

- Up to 3 alarm clock settings can be stored. Only one setting can be enabled.
- Make sure that you set the date and time in the “Set time” beforehand. → p.65
- During the “PIM lock”, you cannot set the Alarm clock.
- For the alarm notification for the Alarm clock, see p.209.

Setting the time for the alarm clock

1 Select   ► “Alarm clock”.

2 Press  [Set].

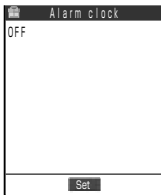

When no alarm clock setting is set

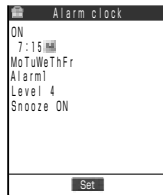

When the alarm clock settings are set

The list screen for stored alarm clock settings appears.

When no alarm clock setting is set
The alarm clock setting operation starts. Go to Step 4.

3 Highlight “<Not stored>” and press  [Edit].





To change the stored alarm clock setting

Highlight the item with the time set and press  [Edit].

4

Specify the respective settings in order.



- Time setting : Set the time when an alarm sounds.
- Repeat : Set the repeat pattern for the alarm clock. If "1 time" is set, an alarm sounds only on the day when the alarm clock is set. If "Daily ()" is set, an alarm sounds daily at the set time. If "Select day ()" is set, an alarm sounds on selected days of the week.
- Alarm tone : Set the alarm tone from "INBOX" folder, your original folder, "Pre-installed" folder("Clock Alarm" (pippipi, pippipi), "Pattern 1 to 3", "Melody" and "Alarm"), "Voice announce" and "OFF".
Selecting a tone →p.163
- Volume : Select the alarm volume from one of 8 levels: "Step", "Level 1 to 6" or "Silent". If "Step" is set, the alarm volume increases gradually. The alarm volume increases from Level 1 to Level 6. If "Silent" is set, no alarm tone sounds.
- Snooze setting : Set whether to set the Snooze (repeated notification) ON/OFF. If "ON" is set, an alarm tone sounds continuously for about 1 minute, repeating 6 times at intervals of about 5 minutes. If "OFF" is set, an alarm tone sounds continuously for about 5 minutes.

Changing the alarm clock setting

You can change the alarm clock setting to other stored setting.

1 Select   ► "Alarm clock".

2 Press  [Set].

The list screen for stored alarm clock settings appears.

3 Select the item you want to set.



To disable the alarm clock setting

Select "OFF".

To change the settings

Highlight the item you want to change and press  [Edit].

Canceling an alarm clock setting

You can delete a stored alarm clock setting.

● If you delete the current alarm clock setting, the "Alarm clock" setting becomes "OFF".

1 Select   "Alarm clock".

2 Press  [Set].

The list screen for stored alarm clock settings appears.

3 Highlight the item you want to delete and select "Release this" from the function menu.



To delete all items

Select "Release all".

Using the Schedule Function

If you set a scheduled event, an alarm sounds at the specified date and time and a message along with an animated cartoon will let you know about the schedule details. You can also set holidays and anniversaries. You can easily check the set schedules and holidays at the calendar. The calendar can be either monthly or weekly for you to check the number of scheduled events and their details. You can manage your schedule in various ways: storing a regular event such as a regular meeting at the fixed date and time every week, setting an appropriate alarm sound and animation to the contents of a scheduled event, or storing two or more schedules events on the same day.

- Up to 100 scheduled events, 100 holidays and 100 anniversaries can be stored, excluding the number of pre-installed national holidays.
- You can store multiple scheduled events on the same day, but only 1 holiday and 1 anniversary.
- Make sure that you set the date and time in the “Set time” beforehand. →p.65
- For the alarm notification for the Schedule, see p.209

Switching the schedule display

Default setting | Monthly display

The calendar displaying the schedule has the 2 types of displays: “Monthly display” and “Weekly display”. If you press  to highlight the date you want to check, the number of scheduled events and schedule icons stored in the selected date are displayed.

1 Select   ► “Schedule”.

2 Select the item from the function menu.



To switch from monthly display to weekly display
Select “Weekly display”.

To switch from weekly display to monthly display
Select “Monthly display”.

Calendar display



Displays the number of scheduled events stored in the morning and afternoon of the day and schedule icons.

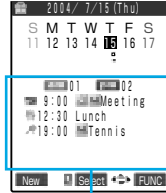

Displays the number of scheduled events stored in the morning and afternoon of the day, schedule icons and the contents of the events.

Date in blue : Saturday

Date in red : Sunday · public holidays

○ : Anniversary

— : Today

□ : Scheduled events in the morning have been stored.

■ : Scheduled events in the afternoon have been stored.

NOTE

- When “Calendar” is set to “Stand-by display” for “Display setting”, dates stored as anniversaries are not displayed in “○” in the calendar on the standby display.
- If you store a scheduled event with the “Holiday” icon set, the assigned date is marked with “□” (AM) or “■” (PM) indicating the schedule, not marked in red indicating a holiday.
- Public holidays are based on the “国民の祝日に関する法律及び老人福祉法の一部を改正する法律(平成13年法律第59号)(Law Partially Revising the National Holidays Law and Old-Age Welfare Law)” (As of June, 2004). If the national holidays are changed or added, store new holidays. Holidays can be changed, deleted and reset them to the original setting.

Storing holidays and anniversaries

You can set birthdays, wedding anniversaries and new national holidays as a holiday or an anniversary. Dates stored as holidays are displayed in red in the calendar. Dates stored as anniversaries are displayed with “○” in the calendar display for the schedule function.

<Example: Setting an anniversary>



2 Press [New] and select “Anniversary”.



To store a holiday
Select “Holiday”.

3 Specify the setting for each item.



Date setting

: Enter the year, month and day of the holiday or anniversary.



Repeat

: Set the repeat pattern for a holiday or anniversary. If “1 time” is set, a stored holiday or anniversary is set only for this year. If “annual ()” is set, a stored holiday or anniversary is set as an annual holiday or anniversary.



Alarm message

: Enter the details of a holiday or anniversary. (the details of a holiday or anniversary)

You can enter up to 10 full-pitch or 20 half-pitch characters.
Entering characters → p.300

4 Press [Finish] to store the anniversary.

NOTE

- If a holiday or anniversary has already stored in the date you set, a message confirming whether you overwrite it or not appears.
- If “annual” is set on February 29 in a leap year, the holiday or anniversary is set only for the year containing February 29.

Storing a scheduled event

If you store a trip or an appointment as a scheduled event, an alarm tone and an animation will inform you of your schedule at the specified date and time.

- Scheduled events are not automatically deleted even if their specified date and time have passed. If you try to store the 101st scheduled event, a message notifying you that storing is not possible anymore appears.
Delete unnecessary scheduled events and store a new event again.
- Be sure to enter the “Alarm message (schedule details)”. You cannot store the schedule if you do not enter the alarm message.

1

Select











▶ “Schedule”.

2 Press [New] and select “Schedule”.



3 Specify the setting for each item.



-  **Date setting (from)** : Enter the start date and time of the scheduled event.
-  **Date setting (to)** : Enter the end date and time of the scheduled event. The dates must be on and after the start time.
-  **Repeat** : Set the repeat pattern for the scheduled event. If “1 time” is set, an alarm sounds only on the day when the scheduled event is set. If “Daily ()” is set, an alarm sounds daily at the specified time. If “Select day ()” is set, an alarm sounds on selected days of the week.
-  **Alarm** : Set the type of alarm notification at the start time. If “ON” is set, an alarm notification is provided at the set data and time. If “ON/Set time” is set, enter the advance notification time in the range of 01 to 99 minutes and the alarm notification is provided at the time. If “OFF” is set, no alarm notification is provided even when the specified time has arrived.
-  **Clock Alarm Tone** : Set the alarm tone from “Inbox” folder, your original folder, “Pre-installed” folder (“Clock Alarm Tone) (pippipi, pippipi), “Pattern 1 to 3”, “Melody”, “Alarm”, “Voice announce”, and “OFF”.
-  **Alarm message (the details of a scheduled event)** : Enter the message to be displayed at the alarm notification and select the icon. You can enter up to 256 full-pitch or 512 half-pitch characters.
Entering characters →p.300

4 Press [Finish] to store the scheduled event.



NOTE

- If you try to store 2 scheduled events at the same date and time, a message confirming whether you overwrite it or not appears.
- Only the combination of “Repeat” (Daily/Select day) and “1 time” (no setting) can be stored at the same date and same time. In this case, the event set to “1 time” is given priority.
- When the day for the date set in “Date setting (from)” and the day specified in “Date setting” for “Repeat” are different, the latter is given priority. Therefore a scheduled event is stored on the first day after the date set in “Date setting (from)”.
- If you store a scheduled event during a call, no alarm tone will sound while you are selecting an alarm tone.
- Scheduled events stored as secret data are not displayed unless you set the FOMA terminal to the “Secret mode” or “Secret only mode”. →p.201
- When you set the calendar on the standby display, you can store a scheduled event from the calendar. →p.177

Important

- We recommend you keep a separate record of schedule data in a notebook or the miniSD memory card (p.365). If you have a PC, you can transfer schedule data by using the data link software (p.472 in 『Application』) and a USB Connection Cable (Optional).
- A breakdown of FOMA terminal or repairing the terminal may cause loss of schedule data. Under no circumstances shall NTT DoCoMo be held liable for any loss or damage to the stored data in your FOMA terminal. Please keep a separate record of schedule data in your notebook.

Setting your favorite image as a user icon

You can set an image or an animation stored in the “Image viewer” (p.302 in 『Application』) as a user icon. The user icons you set will be displayed as “” to “” on the icon selection screen. If you set a user icon, the image or animation you set appears at alarm notification. In addition, “” appears on the indicator display.

- Up to 5 user icons can be set.

1 Select   ▶ “Schedule”.

2 Select “User icon settg.” from the function menu.



3 Select “Not stored”.



To change a user icon that has been set

Select the item for which the user icon has been set.

To cancel all user icons

Select “Release all”.

Only when the user icon has been set, you can release.

4 Select the folder in which you saved images.



If there are your original folders, you can select an image from them. Selecting the images → p.302 in 『Application』

To cancel the user icon of the selected item

Select “Release this”.

Only when you select the item for which the user icon has been set, you can release.

5 Select the item you want to set .



To preview

Highlight the item you want to display and press  [Play].



To switch to the title list display

Select “Title” from the function menu.

To switch to the 4-image display

Select “Picture” from the function menu.

NOTE

- When an image set to a user icon is larger than the display, the image is displayed in the area set in “clipping area” for the “Image viewer” (p.311 in 『Application』).
- If a user icon you want to change has already been used as a schedule icon, a message confirming whether you overwrite it or not appears. If you overwrite the user icon, the schedule icon using it is also changed to .
- If a user icon you want to cancel has already been used as a schedule icon, a message confirming whether you cancel it or not appears. If you cancel the user icon, the schedule icon using it is also changed to .

Checking the contents of a scheduled event

You can display the detailed screen to check the contents of a stored scheduled event.

1 Select   "Schedule".

2 Select the date on which the scheduled event you want to check has been stored.

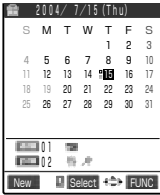







The list screen of the stored scheduled events is displayed.

3 Select the item you want to check.



In the list screen, the following icons appear:

-  : Indicates that a scheduled event has been stored with the set schedule icon.
-  : Indicates that a holiday has been stored.
-  : Indicates that an anniversary has been stored.
-  : Indicates that alarm notification has been set.
-  : Indicates that daily repetition has been set.
-  : Indicates that selected-day repetition has been set.
-  : Indicates that annual repetition has been set.

4 Check the contents.

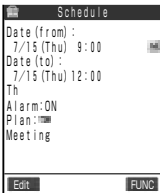

The schedule detailed screen



The holiday detailed screen





The anniversary detailed screen

NOTE

- The schedules set as secret data cannot be displayed unless you switch to "Secret mode" or "Secret only mode".

Displaying scheduled events by icons

You can display scheduled events, holidays or anniversaries by icon set at storing.

1 Select   ▶ “Schedule”.

2 Select “Icon display” from the function menu.



3 Select an icon.



A list of the scheduled events for which the selected icon has been set appears.

NOTE

- In the list screen of scheduled events by icon, repeated scheduled events (“□” or “■”) appear as a single event, and the date of the next closest scheduled event appears.

Checking the number of stored schedules

You can check the number of schedules stored and the remaining number that can be stored.

- The number of stored secret data is included in the number of stored schedules.

1 Select   ▶ “Schedule”.

2 Select “No. of schedules” from the function menu.

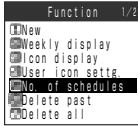

3 Check the number of stored schedules.

A screenshot of the 'Schedule' list screen. It shows a table with the following data:

Schedule	21/100
Holiday	6/100
Anniversary	13/100
Secret	8

- Schedule** : Displays the number of stored schedules.
Number of stored schedules/Maximum number of schedules that can be stored
- Holiday** : Displays the number of stored holidays.
Number of stored holidays/Maximum number of holidays that can be stored
- Anniversary** : Displays the number of stored anniversaries.
Number of stored anniversaries/Maximum number of anniversaries that can be stored
- Secret** : Displays the number of schedules stored as secret data.

NOTE

- Only when the “Secret mode” or the “Secret only mode” is set, their stored number will appear on the display.

Changing the contents of a scheduled event

1 Display the detailed screen of the scheduled event you want to change.

How to display the detailed screen →p.222

2 Press [Edit].

How to edit the schedule →p.218

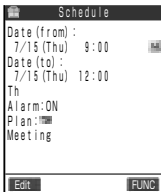

Resetting public holidays

Even if you delete public holidays that have already been registered, you can reset them to the original setting. Go to “Monthly display” or “Weekly display” and select “Reset holiday” from the function menu.

NOTE

- You can also change the schedule by pressing the  [Edit] at Schedule list screen.

Copying a scheduled event

When you store a new scheduled event, you can copy a similar one from the stored schedules. All the contents of the copied source are copied without change except “Date (from)”.

1 Display the detailed screen of the copy source.

How to display the detailed screen →p.222

2 Select “Copy” from the function menu.



3 Store a new scheduled event.

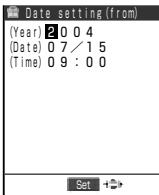

First, the start time setting screen appears. After the start time is set, the schedule entering screen appears. Set the items as necessary.

How to store the schedule →p.218

NOTE

- Even if the repetition setting for the copy source Schedule is set to “Daily (📅)” or “Select day (📅)”, the setting is changed to “1 time (no repeat)” for the copy destination.

Deleting scheduled events

You can delete stored scheduled events, holidays or anniversaries one by one or all at once.

Follow the procedure below to delete scheduled events.

Delete pattern	Description	Executable screen
Delete this	Only one selected item is deleted.	List screen Details screen
Delete past	All items before the selected date are deleted. Select from "Schedule", "Holiday", "Anniversary" or "All".	Calendar screen List screen Details screen
Delete select	Mark the checkbox of the item you want to delete. Only selected items are deleted.	List screen Details screen
Delete all	All the contents of selected items are deleted. Select from "Schedule", "Holiday", "Anniversary" or "All".	Calendar screen

- Even if you select "Delete past" or "Delete select", the holidays stored at purchase are not deleted. If you select "Delete all", the holidays are reset to the default setting.

Deleting one scheduled event

1 Display the list screen of the date of the scheduled event you want to delete.

How to display the list screen →p.222

2 Highlight the item you want to delete and select "Delete this" from the function menu.



Deleting only selected scheduled events

1 Display the list screen of the date of the scheduled event you want to delete.

How to display the list screen →p.222

2 Select “Delete select” from the function menu, and then select the scheduled events you want to delete.



■ Deleting all scheduled events

1 Select “Schedule”.

2 Select the date, and select “Delete past” from the function menu.



To delete all scheduled events
Select “Delete all” from the function menu.

3 Select the item you want to delete.



To delete all the items
Select “All”.

NOTE

- If you try to select Delete this or Delete select for the scheduled event with the repetition setting (“Daily” or “Select day”), a message confirming whether you delete the event or not appears. Select “YES” to delete all the repetition events.
- If you select Delete past for the scheduled event with the repetition setting (“Daily” or “Select day”), all scheduled events up to the day before are deleted. The scheduled events on the selected day or later are not deleted.

Listing Things to Do

If you store your planned events, an alarm sounds at the specified date and time and an alarm message and an animation inform you of your schedule. The icons for planned events after due date are displayed in red. You can manage your schedule in various ways: dividing your planned events into 6 categories such as the event details and due date, assigning priorities to events to confirm them in order of importance, or extracting events that are in a specific status such as “Plan” or “Completion”.

- Up to 100 ToDo entries can be stored.
- Make sure that you set the date and time in the “Set time” beforehand. →p.65
- For the alarm notification for the ToDo, see p.209
- If you paste a ToDo entry as a desktop icon on the standby display, you can quickly call up the function. →p.170

Storing planned events

If you store your important business such as a meeting or Irip in the ToDo, an alarm tone and an animation will inform you of your schedule at the specified date and time.

- Be sure to enter the planned event. You cannot set the ToDo if you do not enter the planned event.

1 Select  ►  ► “ToDo”.







2 Press  [New].

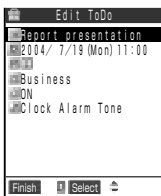

When a planned event is already stored
Select “New” from the function menu.

3 Specify the setting for each item.



-  **Edit ToDo** : Set the details of the planned event. Up to 100 full-pitch or 200 half-pitch characters can be entered.
-  **Due date** : Set the due date of the planned event. To directly enter a due date with the keypad, select "Enter date". To select a due date from the calendar, select "Choose date". To set no due date, select "No date".
-  **Priority** : Set the priority of the planned event.
-  **Category** : Set the category of the planned event. When the category is set, planned events can be displayed by category.
-  **Alarm** : Set the type of alarm notification at the due date. If "ON" is set, an alarm notification is provided at the set date and time. If "ON/Set time" is set, enter the advance notification time in the range of 01 to 99 minutes and the alarm notification is provided at the time. If "OFF" is set, no alarm notification is provided even when the due date has arrived.
-  **Clock Alarm Tone** : Select the alarm tone from "Inbox" folder, your original folder, "Pre-installed" folder ("Clock Alarm Tone (pippipi, pippipi)", "Pattern 1 to 3", "Melody", "Alarm"), "Voice announce" or "OFF".

4 Press [Finish] to store the planned event.

NOTE



- If you store a planned event during a voice call, no alarm tone will sound while you are selecting an alarm tone.

Important

- We recommend you keep a separate record of ToDo data in a notebook or the miniSD memory card (p.365). If you have a PC, you can transfer ToDo data by using the data link software (p.472 in 『Application』) and a USB Connection Cable (Optional).
- A breakdown of FOMA terminal or repairing the terminal may cause loss of ToDo data. Under no circumstances shall NTT DoCoMo be held liable for any loss or damage to the stored data in your FOMA terminal. Please keep a separate record of ToDo data in your notebook.

Checking planned events

You can display the detailed screen to check the contents of a stored planned event.

- 1 Select   "ToDo".

2 Select the planned event you want to check.

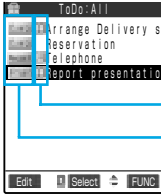

Indicates the priority status.

Indicates the status of the planned event.

3 Check the planned event.

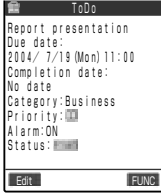

NOTE

- If the due date for an incomplete planned event has already passed the current date/time, the icon for that planned event will turn red. However, that is not the case when the status is set to "Completion".

Changing the way planned events are displayed

You can display stored planned events by category, sort them in chronological order or in the order they were stored, or extract only events that are in a specific status. It is useful for displaying only events in a specific category or displaying incompleting events preferentially.

1 Select   "ToDo".

2 Select “Category display” or “Sort/Filter” from the function menu.



To display events by category

Select “Category display” to choose the category of your choice.



To sort events or extract events in a specific status only

Select “Sort/Filter” to sort or choose the way of filter.

NOTE

- When events are sorted by “By due date”, they are sorted in the due date order from the oldest.
- When events are sorted by “By due date” or “By completed”, events with no due date or completion date are displayed last.
- When events are sorted by “By due date” or “By completed” and the same due date or completion date is set to multiple events, they are displayed by priority beginning with the highest event. Furthermore, if their priority is the same, they are displayed in the order in which they were stored.

Changing the status of a planned event

You can set the status of planned events from among “Plan”, “Acceptance”, “Request”, “Provisional plan”, “Confirmation”, “Denial”, “Completion” and “Substitution”. When you finish your planned event and alarm notification is not necessary anymore, change its status to “Completion”.

1 Select   “ToDo”.

2 Highlight the planned event you want to set and select “Change status” from the function menu.



3 Select an item you want to set.



When “Completion” is selected

Set the completion date. Select an entry method from “Enter date”, “Choose date” or “No date”, and then set the completion date.

NOTE

- You can also set the status from the ToDo detailed screen by selecting “Change status” from the function menu.

Changing planned events

1 Select   “ToDo”.

2 Highlight the item you want to change, and then press  [Edit].

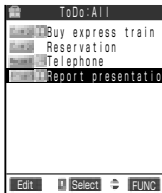

Editing ToDo entries →p.228

NOTE

- You can also change the contents of a planned event by pressing the  [Edit] at the detailed screen of a planned event.

Deleting planned events

You can delete stored planned events one by one or all at once.

1 Select   “ToDo”.

2 Highlight the planned event you want to delete, and select “Delete this” from the function menu.



To select multiple events and delete all of them

Select “Delete select” and select the events you want to delete.

To delete only events with the status set to “Completion”

Select “Delete completed”.

To delete all events

Select “Delete all”.



NOTE

- You can also delete planned events on the ToDo detailed screen from the function menu.

Using the Calculator Function

You can use your FOMA terminal to perform four simple operations (+, -, ×, ÷). The calculator display indicates the Multi-function keys and its surrounding so that pressing the key of the FOMA terminal highlights the corresponding key on the display. Use the keypad to enter numbers.

- Up to 10-digit numbers can be displayed. Up to 9 digits after the decimal point can be displayed.
- If the calculation result exceeds 10 digits, “E” appears.

1 Select  ►  ► “Calculator”.

2 Calculate.

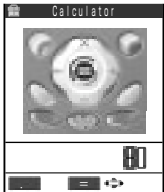

The numbers you entered and the result appear.

To calculate “23+57”









To calculate negative numbers

Only when you attach “-” to the beginning of the first figure, calculation of negative numbers can be implemented.



NOTE

- Press  ( or ) to clear the calculation result or the numeric figures entered.  key is displayed as  immediately after any of “+”, “-”, “×”, “÷” or “=” is entered, and as  during the entry of numerical figures or a decimal point.

Creating a Text Memo

You can make a simple message as a text memo. A stored text memo can be pasted into the contents of the Schedule or into the body of a mail.

- Up to 10 text memos can be stored.
- Up to 256 full-pitch or 512 half-pitch characters can be entered in a text memo.

Storing a text memo

1 Select  ►  ► “Text memo”.

2 Highlight <Not stored> and press [Edit].



To change the contents of a stored text memo
Highlight the text memo you want to change, and then press  [Edit].

3 Enter the text.

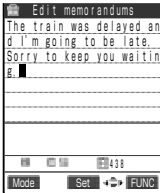

Entering characters →p.300

NOTE

- You can also enter/change the text memo by selecting “Edit” from the function menu.

Important

- We recommend you keep a separate record of Text memo data in a notebook or the miniSD memory card (p.365). If you have a PC, you can transfer Text memo data by using the data link software (p.472 in 『Application』) and a USB Connection Cable (Optional).
- A breakdown of FOMA terminal or repairing the terminal may cause loss of Text memo data. Under no circumstances shall NTT DoCoMo be held liable for any loss or damage to the stored data in your FOMA terminal. Please keep a separate record of Text memo data in your notebook.

Checking the contents of a text memo

You can display the detailed screen to check the contents of a stored text memo.

1 Select   “Text memo”.

2 Select the item you want to check.



3 Check the contents.

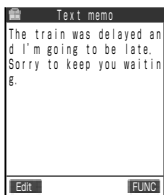

To check the created date and time

Select "Text memo info" from the function menu.

Make date, Last modify date and Category can be checked.

To categorize text memos

Select "Category" from the function menu.

To store the contents of a text memo in the schedule

Select "Edit schedule" from the function menu.

Storing the schedule →p.218

To send the contents of a text memo with an i-mode mail

Select "Compose message" from the function menu.

Composing i-mode mail →p.154 in 『Application』

NOTE

● You can also select the function menu from the text memo list screen.

Deleting text memos

You can delete stored text memos one by one or all at once.

1 Select   "Text memo".

2 Highlight the text memo you want to delete, and select "Delete this" from the function menu.



To select multiple text memos and delete all of them

Select "Delete selected" and select the text memos you want to delete.

To delete all text memos

Select "Delete all".

NOTE



● You can also delete text memos on the text memo detailed screen from the function menu.

Using Dictionaries

There are three types of dictionaries available; English-Japanese, Japanese-English and Japanese.

- You can promptly activate the dictionary function by pasting it as a desktop icon on the standby screen. → P.170
- When there is no perfect match for the word you enter, a list of similar words will be displayed. When there is no similar word, top of the selected dictionary will be displayed.

Activating the Dictionary Function

1 Select   ► “Dictionary”.

2 Select “Enter word”.



To search using words which were looked up previously
Select “Reference history” and then select a word from the Reference history and proceed to step 4.

To paste the dictionary function on the desktop
Select “Add desktop icon” from the function menu.

3 Enter a word you want to look up and then press  [Set] .

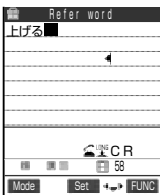

You can enter up to 32 full-pitch or 64 half-pitch characters.

Entering characters → p.300

You can search words in dictionary using hiragana, katakana (full/half-pitch), kanji or alphabets (full/half-pitch).

Only alphabets are searchable in English-Japanese dictionary, and characters except alphabets are searchable in Japanese-English and Japanese dictionary.

4 Select dictionary type.



You can use the Neupointer.

How to use the Neupointer → p.35

5 Select a word from the Reference result and then press [Select].

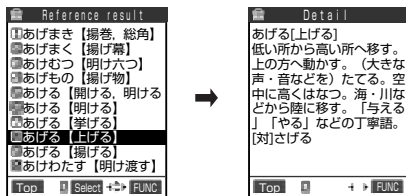

To display lists above or below the list currently displayed.

Press while displaying the list or use the neuro pointer.

To display words above or below the word currently displayed.

Press while displaying the word or use the neuro pointer.

To search entered words using another type of dictionary

Select [Refer dic.] from the function menu.

NOTE

- If you select [Copy] from the function menu, you can copy the words inside **【 】** in the highlighted words while displaying the list, and the words by specifying the range while displaying the details. Copying words → p.319
- Up to 10 words that you searched are stored in the “Reference history”. If the search item exceeds 10, the item is automatically deleted from the oldest one. When you want to delete the reference history, display the reference history and highlight the item you want to delete and then select “Delete this” or “Delete all” from the function menu.

Advanced Lookup from the Detail Screen of Reference Result



You can select a word from the Reference result detail screen and conduct an advanced lookup.

1 Activate the dictionary to look up a word and display the detail screen of Reference result.

2 Select “Re-reference” from the function menu.



3 Press at the beginning of the word you want to look up and then press [Start].

4 Press  at the end of the word you want to look up. The word will be highlighted, and then press  [End].

5 Select a dictionary type.

6 Select a word from the Reference result and press  [Select].

Own number

Storing/Editing Your Own Data

Default setting | Your phone number only

You can store your profile such as your name, home phone number, and mail addresses, etc. If you set your profile, it can be used to check the owner of the FOMA terminal or quote the data entered in the text entry (edit) display.

- Your own number cannot be changed or deleted.
- Your private information other than the own number is stored in the FOMA terminal. If you insert another FOMA card, your private information you stored other than the own number appears.

Storing your personal data

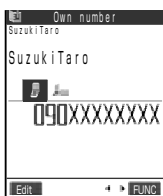

1 Select   ► “Own number”.

2 Press  [Edit] and enter the Security code.



Security code →p.192



NOTE

- When storing your mail address, storing your i-mode mail address as the first mail address is recommended. Pressing   displays the own number as well as the first mail address. Therefore you can check both your own number and mail address at the same time.
- Your i-mode mail address can be checked from the i-mode optional settings. →p.242 in 『Application』
- Even if you change your mail address or store your secret code, the mail address in this profile cannot automatically change. Update the mail address in this profile.
- When a stored image exceeds the image display area in the Own number screen, the image is reduced with the same aspect ratio. If the image is smaller than the image display area, the display is centered.

Viewing your personal data

When this function is started, only your name, own number and the first mail address can be displayed. Enter your security code to display all of your personal data.

1 Select    “Own number”.

You can also display your name, your own number and the first mail address by pressing  and .

2 Select “Display all data” from the function menu, and then enter the security code.



Security code →p.192

3 Press  to check the information in your personal data.



To copy personal data

Display the item you want to copy, and select “Copy name” or “Copy phone No./Copy mail add./Copy address/Copy memorandums” from the function menu.

You can paste the copied data on the character entry screen.

→p.319

To delete personal data

Display the item you want to delete, and select “Erase phone No./Erase mail add./Erase address/Erase Memorandums/Delete image” from the function menu.

NOTE

- You can delete the first mail address without displaying all of your personal data, but entering the security code is required.

Resetting your personal data

You can reset (delete) your personal data other than your own number to return to the default setting.

1 Select   ► “Own number”.

2 Select “Reset” from the function menu, and then enter the security code.



Security code → p.192

When all data is displayed

You do not have to enter the security code.

3 Select “YES”.

To cancel resetting
Select “NO”.

NOTE

- Even if you reset your personal data with this function, your actual mail address is not reset. To reset your actual mail address to “phone number@docomo.ne.jp”, perform “Reset Mail Address” in i-mode option settings. → p.245 in 『Application』

Changing the Menu Display

You can change the menu display that suits your convenience, by changing the way menus are displayed or storing an original menu.

Setting the way menus are displayed

<Menu display set>

Default setting | Guidance: ON | Menu display: Detail

You can set whether to display or not the guidance for a main menu icon selected on the main menu item selection screen, or whether to display the “Settings” menu detail items (functions) in “List” or “Detail”.

With each setting, the screen is displayed as follows:

- The “Original menu” is displayed in “List” regardless of the setting of this function.

About Guidance display



“ON”



“OFF”

About Menu display

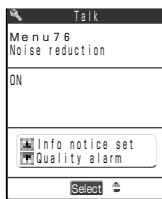

“Detail”

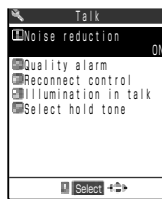

“List”

1 Select   “Display” ▶ “Menu display set”.

2 Select the item you want to set.

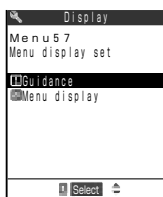

To set the guidance display for high level items

Select “Guidance”.

Select “display the guidance/not display the guidance” (ON/OFF).

To set how the detail items are displayed

Select “Menu display”.

Select the detail item display from “Detail” or “List”.

Displaying your original menu

You can display the functions you stored with the “Original menu” (shown below). Select a function from the original menu to startup the selected function.

- The original menu is displayed in “List”.
- If you paste the original menu as a desktop icon on the standby display, you can quickly call up the function. →p.170



Pressing  switches between the main menu and the original menu.

NOTE

- When you return to the standby display from the original menu, or when you return to the standby display from the original menu after calling up a function from the original menu and performing operations, press  to display the original menu.
- If no function is stored in the original menu, a message asking whether you store functions to the original menu or not appears.

Creating your original menu

<Original menu>

Default setting	Own number, Check new messages, Ring volume, Vibrator, Alarm clock, Change security code
-----------------	--

If you store your frequently used functions, you can quickly call them up from the “Original menu”. Since you do not have to select items in turn from the main menu, the high level item→middle item→detail item, you can easily start up a function you want to use.

- Up to 10 items can be stored in the original menu.
- You can store the following functions in the original menu: The high level items of “Mail”, “i-mode” and “i-αpli” and the middle items and detail items of “Settings”, “Multimedia”, “Accessory”, “Service”, “Phonebook” and “Own data”.
- You cannot store the same function.

1 Select   “Display” ▶ “Original menu”.

2 Select <Not stored>.



To change a stored function

Select the item for which the function is stored.

To cancel a stored function

Highlight the item you want to cancel, and select “Release this” from the function menu.

To cancel all stored functions

Select “Release all” from the function menu.

To reset to the default setting

Select “Reset org. menu” from the function menu.

3 Select a category for the menu.



...

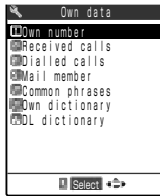

4 Select the functions you want to store.



When the category is “i-mode”

You can select only from among the high level items of “Mail”, “i-mode” and “i-appli”.

NOTE

- You can change or delete the pre-installed functions.
- If you try to store a function in the item already being used, a message confirming whether you overwrite it or not appears.

Recording Your Voice or the Other Party's Voice

There are 2 voice memo functions: the “Voice memo during standby” function, which lets you record your own voice while the standby display is displayed, and the “Voice memo during a call”, which lets you record the other party's voice during a voice/videophone call. It is useful for making a memo of a small task in voice.

- You can record only one Voice memo: either a voice memo during standby or a voice memo during a call. The recorded voice memo is overwritten every time a new Voice memo is recorded.
- The maximum recording time is about 20 seconds.
- For how to play or delete a recorded voice memo, see p.247

Recording your voice

By using “Voice memo”, you will be able to record your own voice.

1 Select   “Voice memo”.

2 Select “YES”.

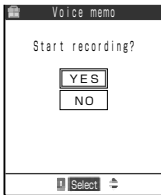



To cancel recording of voice memo
Select “NO”.

3 Record a voice memo.



When a short beep sounds, talk to the mouthpiece. A short beep sounds again about 5 seconds before the recording time (about 20 seconds) ends. When recording ends, a short double beep “pippi” sounds, “Recording” disappears and the previous display reappears.

To cancel the recording after it has started

Press  [Stop],  or .

If you press , the standby display reappears, but the recorded voice is saved.

NOTE

- During a call, “Voice memo during stand-by” changes to “Voice memo during a call”.

Recording the other party's voice during a call





You can record the caller's voice during a voice or videophone call. Simply pressing the key one time records necessary information quickly.

1 Hold down  [Memo/Check] for 1 second or more during a call.



A short beep sounds and recording starts. A short beep sounds again about 5 seconds before the recording time (about 20 seconds) ends. When recording ends, a short double beep "pipipi" sounds, "Recording" disappears and the talking screen reappears.

To cancel the recording after it has started

Press , [Stop], ,  or  for more than 1 second.

If you press , the call also ends.



NOTE

- If you receive a voice/videophone call, 64K data communication or an alarm for "Alarm clock", "Schedule" or "ToDo", or you use other functions during recording, the recording stops.

Playing/Deleting Record Messages and Voice Memos

You can play or delete a message recorded with the "Record message" or "Voice memo".

Playing

For record messages of voice calls, "" appears; for record messages of videophone calls, "" appears. When a voice memo is recorded, "★" appears.

- If the caller notifies his/her caller ID, the caller's phone number appears while playing the record message. If the caller is stored in the phonebook, the caller's name also appears.

1 Select    ▶▶ "Play/Erased msg."

2 Select the item you want to play.



A short beep sounds and playing starts. When playing ends, a short double beep “pippi” sounds and “Playing” disappears.

To play the next message

Press [Memo/Check].

Pressing [Memo/Check] plays the next new message. The voice memo is played last.

To cancel the playing after it has started

Press [CLR].

To make a voice call to the displayed phone number during playing a message

Press [Call].

To make a videophone call to the displayed phone number during playing a message

Press [VCall].

To delete the message being played

Press [Erase].

NOTE

- You can also play a message by pressing [Memo/Check] while the standby display is displayed.
- If no “Record message” and no “Voice memo” is recorded, a message notifying you that there is no message recorded appears.

Deleting

1 Select ► ► “Play/Erase msg.”.

2 Highlight the item you want to delete, and select “Delete this” from the function menu.



To delete all record messages

Select “Delete rec. msg.”.

To delete all record messages and a voice memo

Select “Delete all”.

NOTE

- Press [Erase] during playing a message to delete the message being played.

Important

The contents of the messages may be lost if the FOMA terminal is damaged, repaired or otherwise handled in a way that causes such information in memory may be lost. It is the user’s responsibility to keep a separate record of all information recorded in voice messages. Under no circumstances shall NTT DoCoMo be held liable for any loss of or damage to the stored data in your FOMA terminal.

Recording/Playing an Alarm or Hold Tone

You can record your voice and set it as an original ring tone or answer message.

- You can record 2 voice messages: “Voice announce 1” and “Voice announce 2”.
- The maximum recording time is about 15 seconds.
- You can set your voice messages recorded with this function for the following functions:
 - Ring tone
 - Ring tone for Call setting w/o ID
 - On hold tone
 - Holding tone
 - Answer message for Record message
 - Alarm tone for Alarm clock
 - Alarm tone for Schedule
 - Alarm tone for ToDo
- Melody player can also play recorded voice. →p.341 in 『Application』

Recording voice data

1 Select   ▶ “Voice announce”.

2 Select the item you want to record.

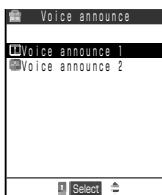



3 Select “Record” to start recording your voice.



A short beep sounds and recording starts. Talk to the mouthpiece. A short beep sounds again about 5 seconds before the recording time (about 15 seconds) ends.

When recording ends, a short double beep “pippi” sounds, “Recording” disappears and the previous display reappears.

To cancel the recording after it has started

Press ,  or .

If you press  during recording, the standby display reappears, but the recorded voice is saved.

NOTE

- When there is recorded voice data, a message notifying you that the voice data has already been recorded appears. If you select “YES” and record new voice data, the existing voice data is overwritten.
- If you receive a voice/videophone call, 64K data communication or an alarm for “Alarm clock”, “Schedule” or “ToDo”, or you use other functions during recording, the recording stops.

Playing recorded voice data

1 Select   “Voice announce”.



2 Select the item you want to play.



3 Select “Play” to start playing voice data.



To cancel the playing after it has started

Press  [Stop],  or .

To delete voice data

Select “Erase”.

To set whether to emit the start tone before alarm notification

Select “Set start tone”.

Specify whether or not to emit (ON/OFF) the start tone before alarm notification.



If “ON” is set, “★” is displayed and a short double beep “pipip” sounds before the recorded voice plays as an alarm tone for the “Alarm clock”, “Schedule” or “ToDo”.

NOTE









- If you delete the voice data set to the ring tone, alarm tone, answer message or hold tone, the setting of each function returns to the default setting. In case of “Melody player”, the program editing data will be deleted.

Setting the Neuropointer

Default setting | Pointer: ON Focus: Follow

To increase the usability of the pointer ( :Blue /  :White) operated with the Neuropointer key “”, you can change its operational setting such as the display ON/OFF, the focus setting and its moving speed.

You can set the following items:

Item		Description	See page
Pointer		Sets whether to display the pointer or not (ON/OFF). If “OFF” is set, no pointer appears even if you slide  .	below
Focus		Sets the pointer operation whether to select an item automatically in accordance with its movement or not (Follow:  (Blue)/Nonfollow:  (White)). If “Follow:  (Blue)” is set, an item under the pointer is automatically selected so that you can select the item by simply pressing  . If “Nonfollow:  (White)” is set, move the pointer over the item you want to select and press  to highlight the item, and then press  again to select it.	below
Speed	Standard	Adjusts the pointer speed for standard screens such as the list screen and icon selection screen.	p.252
	MainMenu	Adjusts the pointer speed for the main menu.	
	T9/Prediction	Adjusts the pointer speed for the T9 (Mode 3) reading candidate screen and prediction screen.	
	Software	Adjusts the pointer speed for screens during activating i-αppli.※	
	Reset	Resets the pointer speed to the default setting.	
Slide	Adjust	Adjusts the maximum slide range of the Neuropointer key to move the pointer properly.	p.253
	Reset	Resets the slide adjustment value to the default setting.	

※ : Depending on the i-αppli software, this setting may not be effective.

● You can use the pointer on the screens with “” displayed.

1 Select   “Other settings”  “Neuropointer”.

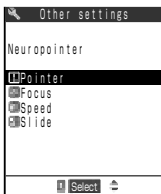

To set the display

Select “Pointer”.

Set whether to display the pointer or not (ON/OFF).

To set the focus

Select “Focus”.

Select the pointer’s focus type from “Follow/Nonfollow”.

To adjust the speed

Select “Speed”.

To adjust the slide range

Select “Slide”.

NOTE

- Even if “Pointer” is set to “OFF”, “” is displayed on the bottom of the screen on which the pointer is available.

Adjusting the pointer speed

You can adjust the pointer speed as you like. If you use the pointer to adjust the speed, the value being adjusted is reflected to the pointer. Therefore you can adjust the speed while checking it.



- To adjust the pointer speed correctly, adjust in the order of “① Initial speed”, “② Low speed area” and “③ High speed area”.

1 Select “Speed” on the Neuropointer setting screen (p.251).

2 Select the item for which you want to adjust the speed.



To reset the speed adjusted value
Select “Reset”.

3 Press  to select “ I ”, “ L ” or “ H ”, and then press  to adjust the speed.

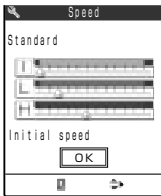

You can adjust each speed to one of 0 (left edge) to 11 (right edge) levels. Moving  to the right increases its speed, and to the left decreases its speed.
Speed adjustment → p.253

4 Select “OK”.



Speed adjustment

The pointer speed increases in 3 steps as the Neuropointer key is slid: “① Initial speed”→“② Low speed area”→“③ High speed area”. The speed for each step is as follows: “① Initial speed” is the adjusted value for “① Initial speed”; “② Low speed area” is the total of the adjusted values for “① Initial speed” and “② Low speed area”; and “③ High speed area” is the total of the adjusted values for “① Initial speed”, “② Low speed area” and “③ High speed area”. Accordingly, if the adjusted values for “② Low speed area” and “③ High speed area” are set to 0 (left edge), the pointer speed remains at “① Initial speed” because nothing is added to the value for “① Initial speed”. If the adjusted values for “② Low speed area” and “③ High speed area” are set to 1 or larger, the pointer speed increases as the Neuropointer key is slid because the values for “② Low speed area” and “③ High speed area” are added to that for “① Initial speed”.

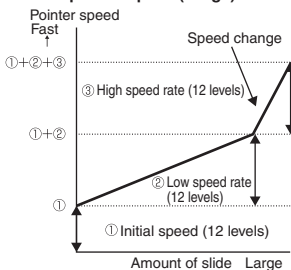
Relation between the amount of slide and the pointer speed (Image)



NOTE

- Even if “Pointer” is set to “OFF”, pressing  adjusts the pointer speed. However, you cannot adjust the speed, checking it with the pointer.
- The speeds such as the pointer speed or the speed for automatic item selection in  (Follow) may differ depending on the screen to be operated.

Adjusting the slide range

If the pointer movement becomes unstable, adjust the maximum slide range of the Neuropointer key.

- Adjust the slide in the order of upper, lower, left and right direction.

1 Select “Slide” on the Neuropointer setting screen (p.251).

2 Select “Adjust”.



To reset the slide adjusted value
Select “Reset”.

3 Select “YES”.



To cancel slide adjustment
Select “NO”.

4 Slide the Neuropointer key according to the guidance on the screen.

Slide the Neuropointer key all the way upward/downward/left/right, and hold it until the guidance disappears.

After adjusting in upper/lower/left/right direction, a message notifying you that the slide adjustment is completed appears.

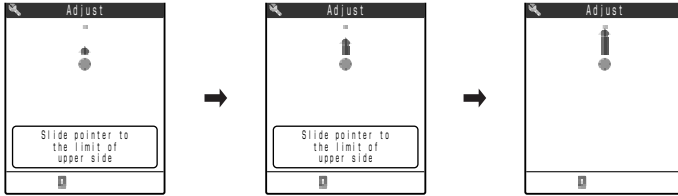

NOTE

- If you receive a voice/videophone call, 64K data communication or an alarm for “Alarm clock”, “Schedule”, “ToDo”, or you use other functions during slide adjustment, the adjusted value is destroyed. When the operation of other function is finished, the slide adjustment screen reappears. Adjust the slide again from the upper direction.

Reset settings

Resetting the Settings

You can reset the settings for various functions to the default setting.

- The settings cannot be reset while the “PIM lock” is set.
- During connecting to external devices such as PC, “USB mode setting” does not reset to the default.
- To reset the i-mode function settings to the default settings, perform “Reset settings”. →p.126 in 『Application』
- Please refer to p.369 for the settings that cannot be reset with this function.

1 Select   “Other settings”  “Reset settings”, and then enter the security code.

Security code →p.192

2 Select “YES”.





To cancel resetting
Select “NO”.

Functions that can be reset

Function		Default setting	
Settings	Incoming call	Ring volume	Phone/V-phone: Level 4 Mail/Message: Level 4
		Select ring tone	Phone: Pattern 1 Video-phone: Pattern 1 Mail: Pattern 2 Msg. Request: Pattern 3 Msg. Free: Pattern 3
		Vibrator	Phone: OFF Video-phone: OFF Mail: OFF Msg. Request: OFF Msg. Free: OFF
		Illumination	Phone: Color 5 Video-phone: Color 5 Mail: Color 1 Msg. Request: Color 1 Msg. Free: Color 1 Pattern: Standard Color setting: Color 1 to Color 12 Adjust color tone: Reset
		Manner mode set	Manner mode Original settings Record msg.: OFF Vibrator: ON Phone vol.: Silent Mail vol.: Silent Alarm vol.: Silent VM tone: ON Keypad sound: OFF Mic sensitiv.: Up LVA tone: OFF
		Disp. phonebook image	ON
		Answer setting	Any key answer
		Fold setting	End the call
		Mail/Msg. ring time	Mail: ON Set ringing time: 5 seconds Msg. Request: ON Set ringing time: 5 seconds Msg. Free: ON Set ringing time: 5 seconds
		Ring time	Set mute seconds: 0 second Missed calls display: Display
		Info notice setting	For Japanese : Beep For English : ON
		Talk	Noise reduction
	Quality alarm		High tone
	Reconnect control		No tone
	Illumination in talk		OFF
	Select hold tone		On hold tone: Tone 1 Holding tone: Melody

Function		Default setting		
Settings	Video-phone	Image quality	Normal	
		My image sending	ON	
		Select image	On hold: Pre-installed Holding: Pre-installed Camera off: Chara-den Record message: Pre-installed	
		Voice call auto switch	OFF	
		Remote monitor	Other ID: Not stored Ringing time: 5 seconds Set: OFF	
		Select image V-phone	Main display: Other image Change display size: Main display size	
	Display	Display setting	Stand-by display: Aqua Wake-up display: Tropical Fish Wake-up message: None Dialing: Standard Calling: Standard Mail sending: Standard Mail receiving: Standard Checking: Standard	
		Display light	Lighting: ON + Power saver mode ON + Light time 5 minutes Charging: Standard Area: LCD+Keys Brightness: Level 2	
		Color pattern	Pattern 1	
		Indicator display	Display information Contrast: Level 5 Clock type: Digital Phone No.: ON Mail: OFF Display connection: ON + Display light OFF Display clock only Contrast: Level 5 Clock type: Digital	
		Font	Type: Font 1 Thickness: Medium	
		Original menu	Own number Check new messages Ring volume Vibrator Alarm clock Change security code	
		Menu display set	Guidance: ON Menu display: Detail	
		Viewer settings	Picture	
		Automatic display	OFF	
		Call data	Call time display	ON
		Clock	Clock display	Display: Same as the setting in "Language" Size: Big
	Alarm setting		Alarm preferred	

	Function	Default setting	
Settings	Lock/Security	Self mode	OFF (Canceled)
		Keypad dial lock	OFF (Canceled)
		Reject unknown	Accept
		Call setting w/o ID	All Accept/Same as ring tone
	Connection setting	Connection timeout	60 seconds
		i-mode checking	Mail: ON Msg. Request: ON Msg. Free: ON
		Host selection	i モー ド (i-mode) User defined host: Back to Not stored
		SMS center selection	DoCoMo
		Certificate	All valid
		Certificate host	DoCoMo User defined host: Back to Not stored
		i-αplli settings	Display software info
	αDisplay light		Depend on system
	αVibrator		Depend on system
	αIndicator display		Depend on system
	External option	Earphone	Earphone+Speaker
		Automatic answer	OFF Ringing time 6 seconds
	Other settings	Keypad sound	ON
		Charge sound	ON
		SRS_WOW setting	ON
		Side keys guard	OFF
		Input method	Input mode: All valid Prior mode: Mode 1 (5-touch) Prediction: ON Guidance: ON T9 Change mode: T9 Kanji change mode
		Record display set	Received calls: ON Redial/Dialled cal.: ON
		Subaddress setting	ON
		Prefix setting	Prefix name: WORLD CALL Prefix: 009130010 (User setting: Back to Not stored)
		Neuropointer	Pointer: ON Focus: Follow Speed: Initial speed
		USB mode setting ^{** 1}	Communication mode

Function		Default setting
 Accessory	Camera	Camera setting: Rear camera Interval: 0.5 second Number: 5 CHG cont. mode: Auto Format setting Megapixel mode: 1616 × 1212 Photo mode, Continuous mode, Picture voice: Mail (L) (176 × 144) Movie mode, Chance capture, Long duration mode: size Large (176 × 144) File size setting: Mail attachment Storage setting: Normal File restriction: File unrestricted Auto save set: OFF Auto timer: 10 seconds White balance: Auto Shutter sound: Sound 1 Display size: Actual size Image tuning: Auto
	Schedule	Monthly display User icon: Back to Not stored
	Alarm clock	OFF
	Record message	OFF Answer message: Japanese 1 Ringing time: 8 seconds
	Voice announce	Set start tone: ON
	Forwarding image	ON
 Service	Arrival call act	Answer
 Phonebook	Utilities	All OFF
	Restrictions	All OFF
 Own data	Common phrases	Preset common phrases: Reset (Reset Folders 1 and 2 including folder names)
 Multimedia	Image viewer	Set image disp.: Actual size
	Movie player	Listing: Title + image Change display size: Actual size
	Chara-den player	Rec. Chara-den: Photo mode Substitute image: (Dimo) Set image display: Fit in display Display size: size Large (176 × 144) Movie type: Normal Storage setting: Standard
Other settings	Volume	Level 4
	Manner mode	OFF
	Driving mode	OFF
	V-phone setting	Adjusting brightness: 0
	Display light for V-phone	All time ON
	Last one function for phonebook search ^{※2}	Reading search
	Last one function for desktop icon ^{※2}	Left edge on the first page

※1 : The setting cannot be reset while the FOMA terminal is connected by a USB cable.

※2 : The "Last one function" is a function that sets the function selected in the last operation to be the one selected for the next operation.

Setting the Communication Service Company

※ You do not need to change the setting if you are using DoCoMo.

Default setting | DoCoMo

You can set the PLMN (telecommunication carrier) that provides you with the FOMA service.

● As of June 2004, you cannot select telecommunication carriers other than DoCoMo.

1 Select  ►  ► “Other settings” ► “PLMN setting”.

2 Select “Manual”.

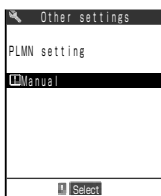

3 Select the PLMN (telecommunication carrier).

Using an Earphone

If you use the earphone/microphone with switch, you can hear the other party's voice through it so that you can talk without worrying about voice leaking out. To connect the earphone/microphone with switch to the FOMA terminal, open the cover of the earphone/microphone socket of the terminal and plug the earphone/microphone with switch. →p.34

Using an earphone

- Plug the earphone/microphone securely into the FOMA terminal. If not, you may not hear any sound.
- Note that an incoming call may be answered if you connect the earphone/microphone after ringing starts.
- Do not wrap the cord of the earphone/microphone around the FOMA terminal. The radio reception level may be reduced.
- A snap sound may be emitted at the moment of power-on. This phenomenon is not a failure.
- If the plug of the earphone/microphone is not firmly inserted, you may hear a beep tone during a call. This phenomenon is not a failure.

Receiving a call with the earphone/microphone with switch

While you are using the earphone/microphone with switch, you can answer an incoming voice or videophone call by only pressing the earphone switch.

- For the earphone/microphone with switch available for use with the FOMA terminal, see “Options and Accessories” (p.354).
- The earphone/microphone with switch can also be used while the FOMA terminal is folded.
- Regardless of the “Keypad sound” (p.168) setting, a tone for connecting and disconnecting a call sounds.

1 When receiving a call, press the switch on the earphone/microphone with switch.

Voice calls

You will hear a short beep before you can answer the call.

Videophone calls

You will hear a short beep before you can respond to the videophone call in a substitute image. Press  to switch to camera view.



2 When you finish the conversation, hold down the switch on the earphone/microphone with switch for 1 second or more.

A short double beep “pipipi” sounds and the call is disconnected.

To end a call with the FOMA terminal

Press .

NOTE

- Even when the earphone/microphone with switch is connected, you can still respond to the phone call by using the FOMA terminal key. Press  to answer the voice call. Press  to answer the videophone call with the camera view. Press  to answer the videophone call with a substitute image.
- You can mute the speaker when the earphone/microphone with switch is connected by “Earphone”. However, the ring tone of remote monitoring incoming calls and the shutter sound of the camera sound from the speaker.
- You can answer an incoming call automatically without pressing the switch on the earphone/microphone with switch if “Automatic answer” is set to “ON”. →p.262
- When the “Ring volume” for the “Phone/Video-phone” is set to “Silent” or during the manner mode, no ring tone sound. However, if the manner mode is set to “Original” and other than “Silent” is set to “Phone vol.”, the ring tone sounds.
- Holding down the switch on the earphone/microphone with switch for 1 second or more during a call does not switch to the handsfree mode. Note that the call is disconnected if you hold down the switch for 1 second or more.
- Subscribers to the “Call waiting” service (p.281) can use the switch on the earphone/microphone with switch to answer a second call while you are talking. However, you cannot end the call with this switch.
- Do not press the switch on the earphone/microphone with switch repeatedly. This may cause calls to be received automatically.

Turning off sounds emitted by the speaker when the earphone/microphone is connected <Earphone>

Default setting | Earphone+Speaker

You can mute the speaker when the earphone/microphone with switch (optional), etc. is connected by “Earphone”.

- Even if you mute the speaker, both the earphone and the speaker emit the sound after a ring tone or an alarm tone for “Alarm clock”, “Schedule” or “ToDo” continue to sound for twenty seconds.
- Regardless of the FOMA terminal setting, the ring tone of the remote monitor and the shutter sound of the camera will be out of the speaker.
- When the earphone/microphone is connected, the speaker does not emit the sound even if you switched to the handsfree mode regardless of this function setting.

1 Select   “External option”  “Earphone”.



To hear the sound from both the earphone and the speaker
Select “Earphone+Speaker”.

To hear the sound only from the earphone
Select “Earphone”.

NOTE

- Even if this function is set to “Earphone”, the sound emits from the speaker when the earphone/microphone is not connected.
- When this function is set to “Earphone+Speaker”, if the earphone/microphone is inserted and extracted repeatedly, the quality of the sound emitted from the speaker may be changed.

Receiving a call automatically with the earphone<Automatic answer>

Default setting | Automatic answer: OFF | Ringing time: 6 seconds

When the earphone/microphone with switch (optional),etc. are connected, you can automatically receive incoming voice or videophone calls without pressing the switch.

- To receive a call, set the ringing time in the range of 1 to 120 seconds.
- The ringing time of Automatic answer cannot be set to the same time as that of the “Record message” or “Remote monitor”.
- Calls from the following phone numbers are not received automatically:
 - Phone numbers for which “Call rejection” is set
 - Phone numbers for which “Voice mail” is set
 - Phone numbers other than those for which “Call acceptance” is set
 - Phone numbers for which “Call forwarding” is set
- Calls are not automatically received during 64K data communication.

1 Select “External option” ▶ “Automatic answer”.

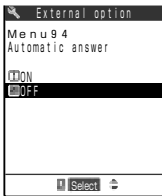

To activate the Automatic answer

Select “ON” and set “Ringing time” in the range of 1 to 120 seconds.

To deactivate the Automatic answer

Select “OFF”.

NOTE

- When this function is set to “OFF”, you can answer a call by pressing the switch on the earphone/microphone with switch.
- When a videophone call is automatically received by this function, the substitute image is displayed at the other party’s side. Pressing  during a videophone call switches between the substitute image and the camera view.
- To give a higher priority to the Automatic answer over the “Voice mail” service (p.273) or “Call forwarding” service (p.278) when the service is activated together with this function, set the shorter ringing time for this function than that for the “Voice mail” service or “Call forwarding” service.

Multi Access

Multi access is a function to allow you to simultaneously use a voice call, packet communication and SMS. With this function, you can make multiple communications at the same time such as receiving a mail during a voice call or making a call during i-mode.

Communication lines available simultaneously

With this multi access function, the FOMA terminal can use the following three lines simultaneously:

Communication sector	Connection
Voice call	One line
i-mode, i-appli, i-mode mail	Any one line
Packet communication by connecting to PC	
SMS	One line

- For the Multi Access Combination Patterns, see p.351.

NOTE

- During the multi access (when using i-mode during a voice call), communication charge is required for each communication line.
- During a videophone call, the multi access is not available but SMS is available for only receiving messages.
- During 64K data communication, the multi access is not available but SMS is available for both receiving and sending.

Receiving a call during communication

When receiving a call from another line during communication, you can make second communication simultaneously without interrupting the first communication.

Receiving an i-mode mail during a voice call

When receiving an i-mode mail during a voice call, the i-mode mail is received on the talking screen. You can read the received i-mode mail without ending the call.

1 Hold down  for 1 second or more.

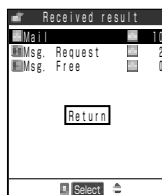

The i-mode mail received result screen appears.

To switch the screen from the task menu

Switching of the task menu → p.268

2 Read the i-mode mail.





How to read i-mode mail → p.185 in 『Application』

3 Hold down for 1 second or more.

The display changes to the talking screen.

NOTE

- No ring tone sounds and “Mail” icon notifies by turning on or flashing when you receive an i-mode mail or Msg. Request/Free during a voice call.
- If you receive an i-mode mail during a voice call when “Receiving display” (p.228 in 『Application』) is set to “Alarm preferred”, “” flashes and the display changes to the i-mode receiving screen. After receiving, press  [Select] to read the i-mode mail. In addition, the talking screen will reappear if you did not operate for about fifteen minutes from receiving.

Receiving a voice call during i-mode/packet communication

When receiving a voice call during i-mode connection, mail transmission or packet communication, the display changes to the incoming voice call screen. You can answer the call without disconnecting these communications.

- You cannot receive videophone calls when you are using i-mode.

1 Press .



The display changes to the talking screen, and you can talk.

To return to the i-mode screen without answering the call

Hold down  for 1 second or more.

The other party does not hear the message and is waiting for you to answer the call.

2 When you finish the conversation, press .

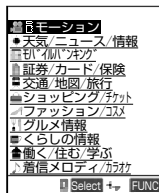

The call ends and the i-mode screen reappears.

To return to the i-mode screen while talking

Hold down  for 1 second or more.

Receiving a voice call during 64K data communication

When receiving a voice call during 64K data communication, the ring tone sounds and the incoming call message appears. Perform any of the following operations because the voice call cannot be used during 64K data communication:

- Continue 64K data communication without answering the incoming voice call
- Connect the incoming voice call to the “Voice mail” service
- Connect the incoming voice call to the “Call forwarding” service
- Disconnect 64K data communication and answer the incoming voice call

<Example: Disconnecting 64K data communication to answer the incoming voice call>

1 Press [Select] in the voice call receiving screen.

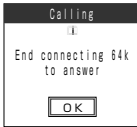

Disconnect 64K data communication on a PC.

2 Press .



64K data communication is disconnected and the voice call is connected.

To reject the incoming call

Select “Call rejection” from the function menu.

To forward the call to the specified phone number

Select “Call forwarding” from the function menu.

To connect the call to the voice mail service center

Select “Voice mail” from the function menu.

NOTE

- To disconnect 64K data communication and answer a voice call, first disconnect the active dial-up connection.

Using another communication during communication

You can implement second communication simultaneously by using another line without interrupting the current communication.

- To switch the display while using the multi access function, hold down  for 1 second or more, or select a function you want to display from the task menu. →p.268

Connecting to i-mode during a voice call

Press  during a voice call to display the i-mode menu from the main menu. From the i-mode menu, connect to the i-mode. →p.42 in 『Application』

Sending an i-mode mail during a voice call

Press **Menu** during a voice call to display the mail menu from the main menu. From the mail menu, you can compose and send an i-mode mail.

1 Press **Menu during a voice call, and select the mail menu.**



Menu operations →p.44

2 Compose and send an i-mode mail.



Composing/Sending i-mode mail →p.154 in 『Application』

3 Hold down **MULTI for 1 second or more.**

The talking screen reappears.

Making a voice call during i-mode

You can make a voice call during i-mode connection or mail transmission without ending i-mode.

1 Hold down **Menu for 1 second or more during i-mode.**

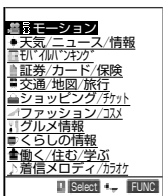

The standby display is displayed.

2 Make a voice call.



How to make a voice call → p.70

3 When you finish the conversation, press .

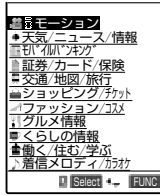

The call ends and the i-mode screen reappears.

To return to the i-mode screen while talking

Hold down  for 1 second or more.

NOTE

- If you make a videophone call during i-mode, a message saying “Disconnecting” will appear, and then you can make a videophone call. When you finish a videophone call, the i-mode screen will reappear.

Multi Task

Multi task is a function to allow you to simultaneously use multiple functions. You can use up to 3 functions simultaneously from the following main menu groups, one function from each group.

Group	Task
Mail group	Menu functions in Mail
i-mode group	Menu functions in i-mode and i-appli
Setting group	Menu functions in Settings and Service
Tool group	Menu functions in Multimedia, Phonebook, Accessory and Own data



- As for i-mode group, Setting group and Tool group, you cannot use two or more functions of the same group simultaneously.
- You are charged for a call charge even while using other functions during a call.
- See p.352 for details on multi task combinations.

Calling up task function

Follow the procedure below to call up the second and third tasks.

1 Hold down for 1 second or more.

The standby display appears.

2 Select a task of a group that has not been activated.

To call up from the main menu

Press , and select the task. →p.44

To call up from the menu number

Enter the menu number of the task you want to call up. →p.355

To call up the mail menu

Press  →p.143 in 『Application』

To call up the i-mode menu

Press  →p.32 in 『Application』

You can check which tasks are called up with the following icons.

 : Indicates that multiple tasks have been called up.

 : Indicates that a single task has been called up.

No icon : No task has been called up.

NOTE

- The task in the same group has already been called up when you try to call up a task, there are two patterns for switching the task: 1) A message appears asking you whether to switch the task or not; 2) The menu function is automatically switched (while the mail menu or i-mode menu is displayed). If the message appears, select “YES” to call up a new task. In this case, the previous task ends and data being edited is automatically saved. Depending on a task, data being edited may not be saved.
- If you try to startup the fourth task when three tasks are already started simultaneously, a message notifying you that functions cannot operate any more appears.

Switching task

When several tasks are activated, you can switch the task to operate. To switch task, there are two ways: 1) press  to display the task menu, and then select a task you want to use; and 2) hold down  for 1 second or more to switch a task by screen.

Switching task with the task menu

When multiple tasks are activated, press  to display the task menu in a list. If you select a task from the list, the selected task appears on the display.

- The standby display is always displayed at the end of the task menu.
- During a voice call, the standby display is not displayed in the task menu.

1 Press .

The task menu is displayed in a list.

2 Select the task you want to use.

The selected task appears on the screen.



Switching task by screen

Hold down  for 1 second or more to switch the task in the order they were started. Switching the task does not end a task in operation or disconnect a voice call.

- While the main menu is displayed, the task does not switch even if you hold down  for 1 second or more.

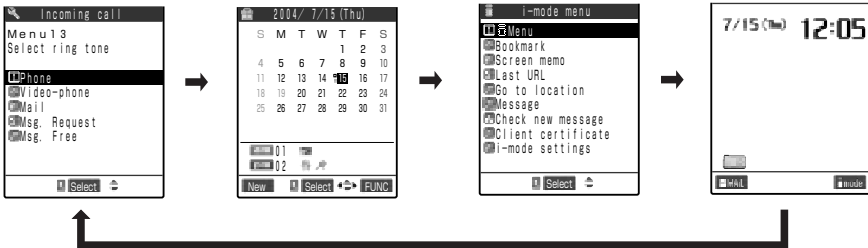





NOTE

- If you display the standby display during the Multi task, the screen set in "Stand-by display" for "Display setting" appears even if the "i-αppli standby display" (p.86 in 『Application』) has been set. The standby display cannot be displayed while other task is operating even if software has the capability to return to the standby display after it is started as i-αppli. Depending on software, during an attempt to return to the standby display, a message notifying you that operation cannot be continued any more and the software ends may appear. In addition, the standby display setting may be canceled.

Terminating task

How to end tasks is as follows.

- Switch to the task you want to terminate, and press .
- Highlight the task you want to terminate while the task menu is displayed, and press .
- Press   while the task menu is displayed to terminate all tasks.

NOTE

- Turning the FOMA terminal off terminates all tasks.



● Using Network Services

Network Services Available for the FOMA Terminal

With the FOMA terminal, you can access the useful DoCoMo network services. For the outline of each service and how to access them, see the table below.

Service name	Description	Subscription	Monthly charge	See page
Voice mail service	Stores messages from callers on your behalf.	Necessary	Charged	p.273
Call forwarding service	Forwards calls to the specified phone number.	Necessary	Free	p.278
Call waiting service	Receives another incoming call from another party during a call.	Necessary	Charged	p.281
Bar nuisance call service	Automatically blocks nuisance calls or frequent malicious calls.	Necessary	Charged	p.284
Notify caller ID service	Informs of your FOMA terminal's phone number to the called party.	Unnecessary	Free	p.285
Caller ID request service	Responds to calls that do not provide a Caller ID by playing a guidance announcement that requests a Caller ID.	Unnecessary	Free	p.286
Driving mode	Will respond to calls by playing a guidance announcement saying that you cannot answer the call because you are driving.	Unnecessary	Free	p.82
Dual network service	Uses the same phone number for both the FOMA terminal and the mobile phone.	Necessary	Charged	p.287
English guidance	Sets voice guidance for incoming and outgoing calls and network service settings to English.	Unnecessary	Free	p.289
Short Message Service (SMS)	Sends/receives short text messages easily.	Unnecessary	Free	p.136 in 『Application』
i-mode	Uses site (program) connection and i-mode mail, etc.	Necessary	Charged	p.24 in 『Application』

- In case of the network services that require connecting to the network service center, you cannot use these while “” is displayed.
- When DoCoMo provides a new network service, you can store the new service into your Menu. →p.295
- Refer to 『FOMA Network Services User's Guide』 for details.

“Voice mail” service, “Call forwarding” service, “Call waiting” service, “Bar nuisance” call service, “Dual network” service and “i-mode” are services which you need to subscribe to. For the network services, contact any of the following numbers (Dial after you check it carefully.);

○ **Inquiries (NTT DoCoMo Group):**

From an ordinary (landline) phone:



0120-005-250 (toll free) (in English)

※ You can call this number from any type of phone, including DoCoMo mobile phones and PHS phones.
※ Check the phone number carefully before dialing.

From a DoCoMo mobile phone or PHS phone:

151 (no area code) (toll free) (in Japanese only)

※ You cannot call this number from an ordinary (landline) phone.

You can subscribe to "Voice Mail Service", "Call Waiting Service", "Call Forwarding Service", "Nuisance Call Blocking Service" and "i-mode Service" via the DoCoMo e-site.



- Using i-mode (no packet communication charge): iMenu ▶ ⑨ Info&Help ▶ DoCoMo e-site
- Using PC:

Access from the DoCoMo website

Access from the DoCoMo website: <http://www.nttdocomo.co.jp> ▶
Online applications/inquiry service ▶ e-site website

Access e-site directly

<http://www.esite.nttdocomo.co.jp>

*You need the network PIN that you specified at the time of application to use e-site via i-mode.

There is no charge for packet communication accessing e-site via i-mode, however some packet communication charges may apply.

*You need a user ID and password to access e-site via your PC.

*If you do not have or forgot your "network PIN", "user ID" and/or "password", please contact the inquiries numbers shown at the bottom of p.272.

*There are times when the site may not be available due to system maintenance, etc.

Voice Mail Service

Subscription Necessary

Monthly charge Charged

When you are having your FOMA show " " or when your FOMA terminal is turned off, this service answers calls with the answer message and stores caller's voice mail messages on your behalf.

You can access the stored voice mail messages from anywhere in Japan.

- You cannot operate the voice mail service with your FOMA terminal when you are having your FOMA show " ". If you set the remote operation for this service in "Remote control" (p.294) beforehand, you can remotely control the voice mail service from general push-key is phones or pay phones by using the "NW security code" (p.192) when your FOMA terminal is unavailable.
- The voice mail service requires a call charge for playing stored voice mail messages in addition to the monthly charge.

About the voice mail service

- Up to 20 voice mail messages can be recorded, each can be recorded up to about 3 minutes long.
- The voice mail messages are stored for up to 72 hours.
- When you receive a videophone call, even if the voice mail service is set to "Activate", the videophone call cannot be connected to the voice mail service center, while the videophone call is continuing.
- If you set the "Call forwarding" service (p.278) to "Activate", the voice mail service is automatically deactivated.
- When receiving a voice call with no caller ID when the "Caller ID request" service (p.286) is set to "Activate", a guidance requesting the caller to notify his/her caller ID is played. The voice mail messages cannot be stored.

Basic flow of the voice mail service

Activate the voice mail service.



Your FOMA terminal receives a voice call.



If you do not receive the voice call, it is connected to the voice mail service center.



A caller records a message.

By pressing **#59#** during the answering message, a caller who is in a hurry can skip the message and proceed directly to recording his or her message.



You are notified that the voice mail service center stores a new voice mail message.



Play the caller's message.

NOTE

- There is also a guide function just to inform the caller that you are unavailable. Set this function in "Voice mail settings".
- You can make or receive voice calls as usual even when the voice mail service is set to "Activate".
- If you receive a voice call when the voice mail service is set to "Active", the ring tone set in "Select ring tone" sounds. If you answer the call while ringing, you can talk. If you do not answer the call, the call is connected to the voice mail service center. The call is recorded as a "Missed calls" in the "Received calls" and the "Missed call" desktop icon appears on the standby display.
- You can also connect a call received during a call to the voice mail service center. →p.293
- Voice calls from the phone numbers specified in the "Restrictions" (p.141) can automatically be connected to the voice mail service center regardless of the voice mail service settings.

Activating the voice mail service

1

Select   "Voice mail".

2

Select "Activate".



To change the ringing time only

Select "Set ringing time".

To stop the voice mail service

Select "Deactivate".

3 Select “YES”.

Not to start the voice mail service
Select “NO”.

4 Enter the ringing time (000 to 120 seconds).

If “0 second” is set, calls are not recorded in the “Received calls”.
If you enter a value outside the range of 000 to 120, a message indicating you that the value is unacceptable appears.

Checking the voice mail service settings

You can check the settings for the voice mail service by inquiring at the voice mail service center. While checking, you can also change the settings.

1 Select   “Voice mail”.

2 Select “Check setting”.

3 Check the settings.



The current settings for the voice mail service appear.

To start the voice mail service

Select “Activate” from the function menu.

To stop the voice mail service

Select “Deactivate” from the function menu.

To change the ringing time

Select “Set ringing time” from the function menu.

Changing the voice mail service settings with the voice guidance

According to the voice guidance, you can play stored messages or change the settings for a function informing that you are unavailable and an answer message.

● You cannot use the voice guidance during a call.

1 Select   “Voice mail”.

2 Select “Voice mail settings”.

You are connected to the voice mail service center.
Once connected, change the settings according to the voice guidance.

NOTE

- If you operate keys ( ~ , , ) according to the voice guidance, the call may not end by pressing . In this case, press  again.

Setting a ring tone to alert you of a new voice mail message <Notify tone message>

You can set your FOMA terminal to alert you when a new voice mail message is stored in the voice mail service center by a ring tone.

- The ring tone set for “Mail” in “Select ring tone” sounds for about 5 seconds when a new voice mail message is stored.

1 Select   “Voice mail”.

2 Select “Notify tone message”.







NOTE

- The ring tone which you set for “Mail” of the “Select ring tone” also sounds even when the number of voice mail messages increases by inquiring with the voice mail service center.

Checks whether voice mail messages are stored <Check messages>

You can check whether voice mail messages are stored in the voice mail service center.

1 Select   “Check messages”.

After checking, a message notifying you that inquiring is completed appears. When a new voice mail is stored at the voice mail service center, you will see on your standby display “” (Voice mail icon) and “” (desktop icon for “Voice mail”). New voice mail icon is different depending on the number of voice mail stored; “”, “”, “” ... “” (10 or more).

NOTE

- Displayed numbers are the count of new voice mail messages to be played. The stored messages are not included.
- When there is no voice mail message, both the voice mail icon and “Voice mail” desktop icon are not displayed.
- The voice mail icon remains displayed until you call the voice mail service center to delete the message, or it is automatically deleted after the maximum storage period (72 hours) has elapsed.
- Note that adverse reception conditions may result in the call being disconnected or that your inquiry fails.
- The voice mail messages recorded after checking messages may not be confirmed with this setting.

Playing voice mail message

- You cannot play a voice mail message during a call.

1 Select   “Voice mail”.

2 Select “Play messages”.

You are connected to the voice mail service center.
Once connected, play voice mail messages according to the voice guidance.

NOTE

- If you operate keys ( , , , , , , , , ) according to the voice guidance, the call may not end by pressing . In this case, press  again.

Deleting the voice mail icon

You can delete “” (Voice mail icon) displayed on the standby display.

1 Select   “Voice mail”.

2 Select “Erase icon”.

NOTE

- Deleting a voice mail icon does not erase the voice mail message. When you perform “Check messages” again, the voice mail icon reappears.

Call Forwarding Service

Subscription Necessary

Monthly charge Free

If you receive a voice or videophone call when you are having your FOMA showing “” or when your FOMA terminal is turned off, this service forwards the call to the forwarding destination such as your home or office you have registered in advance.

- You cannot operate the call forwarding service with your FOMA terminal when you are having your FOMA showing “”. If you set the remote operation for this service in “Remote control” (p.294) beforehand, you can remotely control the call forwarding service from general push-key phones or pay phones by using the “NW security code” (p.192) when your FOMA terminal unavailable.

About the call forwarding service

- You can register one forwarding destination.
- Videophone calls are not connected unless the forwarding destination is a 3G-324M-compliant videophone terminal. (p.87)
- If you set the “Voice mail” service to “Activate”, the call forwarding service is automatically deactivated.
- If receiving a voice call with no caller ID when the “Caller ID request” service (p.286) is set to “Activate”, a guidance requesting the caller to notify his/her caller ID is played. The call forwarding service is not available.

Basic flow of the call forwarding service

Register a phone number of a forwarding destination.



Activate the call forwarding service.



Your FOMA terminal receives a voice/videophone call.



If the voice/videophone call is not answered, the call is automatically forwarded to the specified forwarding destination.

Charges for the call forwarding service

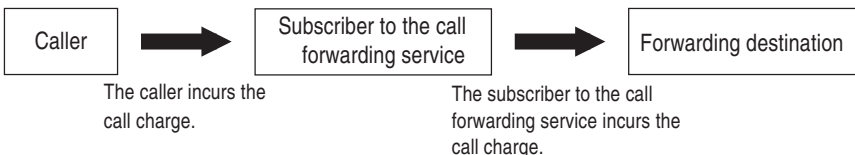

- Registering the forwarding destination, activating/deactivating the call forwarding service or setting the ringing time is free of charge.
- When forwarding a call, the subscriber to the call forwarding service is charged for a call charge from an area where the position of the FOMA terminal is registered to the forwarding destination. Be careful that a call charge for the call forwarding service may be unexpectedly expensive if you do not turn your FOMA terminal on after activating this function at a location far from your home place. For example, suppose you register your office number in Tokyo as the forwarding destination, and activate this function in Osaka during your business trip. In this case, if you leave your FOMA terminal with the power turned off, you are charged for forwarded calls from Osaka to your office in Tokyo. Turn on the power again when you return to home place. The present position of your FOMA terminal is automatically registered.

NOTE

- You can make or receive voice/videophone calls as usual even when the call forwarding service is set to “Activate”.
- If you receive a voice or videophone call when the call forwarding service is set to “Activate”, the ring tone set in “Select ring tone” sounds. If you answer the call while ringing, you can talk. If you do not answer the voice or videophone call, the call is forwarded to the forwarding destination. The call is recorded as a “Missed calls” in the “Received calls” and the “Missed call” desktop icon appears on the standby display.
- A call is automatically forwarded without ringing, when you are outside the service area or in areas out of reach of radio waves or when your FOMA terminal is turned off. In this case, the subscriber to the call forwarding service incurs a call charge from your FOMA terminal to the forwarding destination.
- You can also forward another voice call received during a call. →p.293
- Voice or videophone calls from the phone numbers specified in the “Restrictions” (p.141) can automatically be forwarded to the forwarding destination regardless of the call forwarding service settings.
- The call forwarding service may be stopped on behalf of the subscriber at the request of the party receiving forwarded calls where such action is deemed necessary.
- While the call forwarding service is set to “activate” (during forwarding), a Collect call (calls charged to the receiver) cannot be received.

Activating the call forwarding service

1 Select   “Call forwarding”.

2 Select “Activate”.



To stop the call forwarding service
Select “Deactivate”.

To change the forwarding destination only
Select “Change forwarding No” and enter the phone number of a forwarding destination. If the call forwarding service is set to “Activate”, then select “Change No.”. If set to “Deactivate”, select “Change No.+Activate”.

To check the call forwarding service settings
Select “Check settings”.

3 Set the forwarding destination and ringing time.



To specify the forwarding destination

Select "Register fwd number".

Enter the number to forward a call. After setting, the "★" is attached to "Register fwd number".

If you press , you can search phonebook to enter the number.

How to search the phonebook →p.116

To set the ringing time

Select "Set ringing time" and enter the ringing time (000 to 120 seconds). After setting, the "★" is attached to "Set ringing time".

If "0 second" is set, incoming calls are not recorded in the "Received calls".

If you enter a value outside the range of 000 to 120, a message indicating you that the value is unacceptable appears.

4 Select "Activate".

NOTE

- Even if the call forwarding service is set to "Activate", you cannot forward the received videophone calls if the forwarding party does not have the device that conform to 3G-324M (p.87). Be sure to check the forwarding recipient's device before you set the call forwarding service. Also, the caller who made the videophone call will not hear the guidance announcement that the call is being forwarded.
- You cannot specify toll-free numbers or 3-digit numbers such as 110 as a forwarding destination.
- Be careful that a caller may misunderstand if you set a private branch exchange (PBX), QUICKCAST® or fax number as a forwarding destination.

Connecting to the voice mail service center when the forwarding destination is busy <At fwd party busy>

A forwarded voice call can be connected to the voice mail service center when the forwarding destination is busy.

- A subscription to the "Voice mail" service is required.
- You cannot connect to the voice mail service center if you receive a videophone call.

1 Select "Call forwarding".

2 Select "At fwd party busy".

Call Waiting Service

Subscription

Necessary

Monthly charge

Charged

The call waiting service allows you to receive another voice call during a call. You can also put the current call on hold and make a new call to another person.

- You cannot operate the call waiting service when the “” icon is displayed.
 - Before using the call waiting service, set “Arrival call act” (p.291) to “Answer”. If the setting was something other than “Answer”, you cannot reply to the incoming voice calls while taking another even if you are activating the call waiting service.
 - When receiving a voice call that does not notify Caller ID when the “Caller ID request” service (p.286) is set to “Activate”, a guidance requesting the caller to notify his/her caller ID is played, and the call cannot be received.
 - In the following cases, the call waiting service is not available:
 - During a call to 3-digit phone number, such as 110, 119, 118, 117* or 104
 - During dialing, or while you are waiting for the other party to answer the call
 - During the videophone call (saved in “Received calls” (p.151) as “Missed call”)
 - When you receive a videophone call during voice call (saved in “Received calls” as “Missed call”)
 - During a call to 4-digit phone number for setting the various network services, such as 1411 (for starting the Voice Mail Service) and 1420 (for stopping the Call Forwarding Service).
 - While a call is being connected to the voice mail service center in order to use services such as playing the message etc. This case applies only to the customers who have subscribed to the “Voice mail” service.
- ※ : When you receive a voice call during a call to 117, a secondary call signal sounds. However, you cannot answer the call.

Activating the call waiting service

1 Select   “Call waiting”.

2 Select “Activate”.



To stop the call waiting service settings
Select “Deactivate”.

To check the call waiting service settings
Select “Check setting”.

* Since January 2001, DoCoMo pagers have been called “QUICKCAST”.

Putting the current voice call on hold to answer another voice call

- 1** When you hear a signal tone during a call, press  or  [Answer].

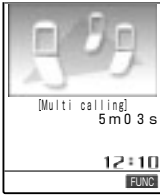

The call with the first caller is automatically put on hold, and another voice call from the second caller is connected.

- 2** Switch the line to the first caller.

To end the call with the second caller

Press , and then press  or  [Answer].

The call with the second caller ends, and the line is switched to the first caller.

To put the call from the second caller on hold

Press .

The call with the second caller is put on hold, and the line is switched to the first caller.

Press  to switch between the callers.

To end the held voice call

Select “End held call” from the function menu.

NOTE

- A caller is charged even while the call is on hold.
- When you receive a third voice call while “Multi calling” is displayed on the screen, a message notifying you that you can answer the third call if you end the call on hold or current call appears.
- If you subscribe to the “Voice mail” service or the “Call forwarding” service, set “Arrival call act” to “Answer” and “Set arrival act” to “Activate” to connect the voice call that came in during another call to the voice mail service or call forwarding service. →p. 293

Ending the current voice call to take another voice call

- 1** When you hear a secondary call signal, press .
- The call with the first caller ends, and the ring tone sounds.

- 2** Press  or  [Answer].
- The second voice call is connected.

Putting the current voice call on hold to make a new voice call to another person

You can put the current call on hold and make a new voice call to another person.

1 Dial a phone number of the second person during a call, and press .



The call with the first caller is automatically put on hold, and the line is switched to the second person.

You can search the phonebook for the number.

How to search the phonebook →p.116

2 Switch the line to the first caller.

To end the call with the second person

Press , and then press  or  [Answer].

The call with the second person ends, and the line is switched to the first caller.

To put the call with the second person on hold

Press .

The call with the second person is put on hold, and the line is switched to the first caller.

Press  to switch between the callers.

To end the held voice call

Select “End held call” from the function menu.

NOTE

- A caller is charged even if the call is on hold.
- When you receive a third voice call while “Multi calling” is displayed on the screen, a message notifying you that you can answer the third call if you end the call on hold or current call appears.

Bar Nuisance Call Service

Subscription

Necessary

Monthly charge

Charged

The bar nuisance call service is the service that calls from specific phone numbers such as malicious calls and insistent sales calls can be registered not to receive them. After registered, calls from such numbers are automatically rejected by the network and callers hear the call rejection guidance.

- You cannot use the bar nuisance call service when the “” icon is displayed.
- When you receive a videophone call from the registered phone number for the call rejection, no call rejection guidance is played and the line is disconnected.
- Up to 30 phone numbers can be registered for the call rejection.
- When you are activating the bar nuisance call service and various network services at the same time, an incoming call is handled as follows:

Network service	When an incoming call comes
Voice mail service	The call rejection guidance is played to the other party. A voice call message will not be stored.
Call forwarding service	The call rejection guidance is played to the other party. The call will not be forwarded to the forwarding destination.
Call waiting service	The call rejection guidance is played to the other party.
Caller ID request service	The call rejection guidance is played to the other party. The guidance requesting the call to notify his/her caller ID will not be played.
Driving mode	The call rejection guidance is played to the other party. The guidance telling that you are driving will not be played.

- Calls not received due to the bar nuisance call service will not be stored into “Received calls”. You will not see the desktop icon “Missed call”.

Registering the last nuisance call you received <Register caller>

The phone number of the last call you received and talked can be registered for the call rejection.

- A call with no caller ID can also be registered for the call rejection.
- An international call cannot be registered for the call rejection.
- You cannot check or inquiry about phone numbers registered for the call rejection. You are recommended to take a note of phone numbers you registered for the call rejection.

1 Select   “Bar nuisance call”.

2 Select “Register caller”.



When 30 phone numbers have been already registered

A message asking you whether to delete the oldest phone number and register a new one appears.

To register a new phone number, delete the oldest entry and then register the last call you received for the call rejection.

NOTE

- You can designate a phone number for the call rejection registration. In this case, make a voice call to “144” directly from the standby display and register a phone number according to the voice guidance.

Deleting phone numbers registered for the call rejection

1 Select   “Bar nuisance call”.

2 Delete the phone number registered to be blocked.

To delete the last phone number registered for the call rejection

Select “Delete last entry”.

Only the last phone number registered for the call rejection can be deleted.

Other registered phone numbers cannot be deleted even if this deletion procedure is repeated.

To delete all phone numbers registered for the call rejection

Select “Delete all entries”.

Notify Caller ID Service

Subscription Unnecessary

Monthly charge Free

The FOMA terminal can notify your phone number to the other party's phone when you make a call. Since the caller ID is your important information, please handle with care when you notify your caller ID.

- You cannot operate the notify caller ID service when the “” icon is displayed.
- The notify caller ID service is available for videophones too.
- This function is available only when the other party's phone is a digital terminal capable of displaying the caller ID.
- When you hear the guidance requesting your caller ID, hang up the phone once. Then set “Notify caller ID” to “ON” and make the call again.

Notifying the caller ID

Default setting OFF

1 Select   “Notify caller ID”.

2 Select “Change setting”.



To check the notify caller ID service settings
Select “Check setting”.

3 Select “ON”, and enter the NW security code.

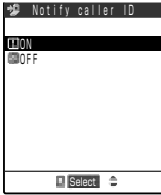

NW security code →p.192

If you do not notify your caller ID

Select “OFF”, and enter the NW security code.

NOTE

- You can also set the notify caller ID to ON or OFF when you dial a phone number or display it from the “phonebook”, “Received calls” or “Redial”. →p.124

Caller ID Request Service

Subscription Unnecessary Monthly charge Free

The caller ID request service responds to voice calls that do not provide a Caller ID by playing an announcement that requests a Caller ID and then automatically terminating the call. This avoids problems caused by unknown callers and allows you to use your FOMA terminal in a carefree manner.

- You cannot operate the caller ID request service when the “” icon is displayed.
- Caller ID request service is unavailable to videophones.
- The Caller ID request service only comes into effect when the reason given for the absence of a Caller ID is “User unset”, indicating that the caller intentionally selected not to send a Caller ID. (This service does not apply to calls where the reason is “pay phone” and “Not supported”.)
- A call for activating/deactivating the caller ID request service is free of charge.
- The caller of an incoming call is charged for the duration the announcement is heard.
- When you are activating various network services – such as “Voice mail” service, “Call forwarding” service, “Call waiting” service, “Driving mode” – and Caller ID request service at the same time, the Caller ID request service is given priority over others; and the incoming calls will be disconnected.

- When you are activating “Bar nuisance call” service and Caller ID request service at the same time, the “Bar nuisance call” service is given priority over others; and the incoming calls will be rejected.
- When you are activating “Call setting w/o ID” (p.145) and “Caller ID request” service at the same time, the Caller ID request service is given priority over others.
- When a call is not received due to the caller ID request service, the call is not recorded in “Received calls” and no “Missed call” desktop icon appears.

Activating the caller ID request service

1 Select   “Caller ID request”.

2 Select “Activate”.



To deactivate the caller ID request service
Select “Deactivate”.

To check the caller ID request service settings
Select “Check setting”.

Dual Network Service

Subscription Necessary

Monthly charge Charged

The dual network service is the service that you can use the same phone number for both the FOMA terminal providing a high-quality communication service and the mova providing a wide service area.

- You cannot operate the dual network service when the “” icon is displayed.
- The dual network service can switch the entire service including the i-mode center and the network service center.
- For details of the dual network service and mova operations, refer to the 『Dual Network Service Guide』.

About the dual network service

- Switching to dual network service is performed with a FOMA terminal or mova that cannot be used within the service.

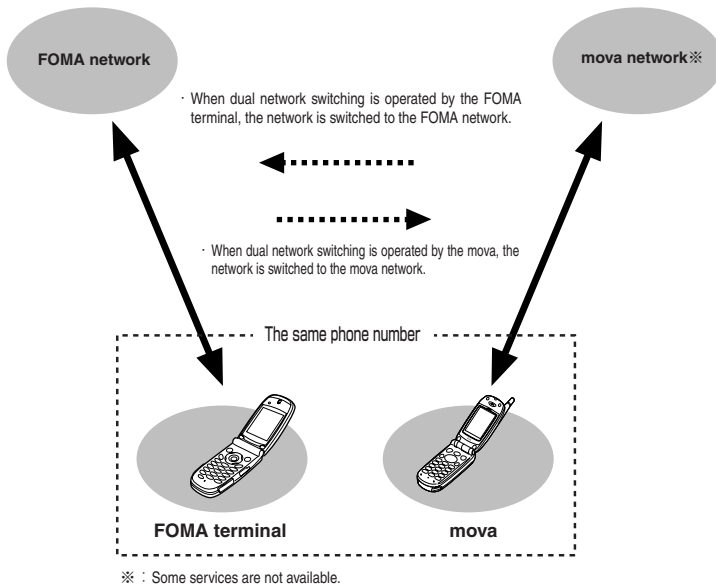

- Network services you have subscribed with your FOMA terminal can also be used with your mova. Note that the following settings are set by each terminal and not reflected to each other.
 - Notify caller ID service
 - Driving mode
 - Arrival call act
- The FOMA terminal and the mova cannot be connected to a network at the same time.
- The following functions are available only in FOMA terminals:
 - Making/Receiving videophone calls · Receiving Msg.Request/Free
 - Sending/Receiving SMS · Checking new SMS
- A mova that supports i-mode can be select whether to receive i-mode mail automatically or check/reply unreceived mails on “Check mails site” in iMenu.
- The network service you have subscribed in the FOMA terminal is also available when you are using mova. However, some network settings made at each terminal may not be interoperable.
- Switching from the FOMA terminal to the mova cannot be done.

Switching from the mova to the FOMA terminal

- Before switching, check that you are in the service area. The reception level on the FOMA terminal and mova screen indicates radio wave conditions, not the status of the network availability.

1 Select   “Dual network”.

2 Select “Switching”.



To check the status of the FOMA terminal availability
Select “Check setting”.

3 Select “YES”, and enter the NW security code.

NW security code →p.192

Not to switch

Select “NO”.

English Guidance

Subscription Unnecessary

Monthly charge Free

You can set a language for the voice guidance to be played at the setting of network services such as the “Voice mail” service or the “Call forwarding” service. You can also set a language for the voice guidance to callers for services such as the “Caller ID request” service.

You can set the following languages for the voice guidance:

	Setting	Guidance language
Outgoing (Guidance for network service setting)	Japanese	The guidance is played in Japanese.
	English	The guidance is played in English.
Incoming [※] (Guidance for callers)	Japanese	The guidance is played in Japanese.
	Japanese+English	First the guidance is played in Japanese, and then in English.
	English+Japanese	First the guidance is played in English, and then in Japanese.

※ : You cannot set English only for the incoming guidance. When talking between DoCoMo mobile phones, the outgoing guidance setting of the calling party is given priority over the incoming guidance setting of the called party.

- You cannot operate the English guidance when the “” icon is displayed.
- English guidance is unavailable to videophones.

1 Select “English guidance”.

2 Select “Guidance setting”.



To check the guidance settings
Select “Check guidance”.

3 Select the item you want to set.



To set the guidance for outgoing and incoming calls

Select “Outgoing+Incoming”. Set the guidance for outgoing calls, and then set the guidance for incoming calls.

Select the guidance for outgoing calls from “Japanese/English”, and select the guidance for incoming calls from “Japanese/Japanese+English/English+Japanese”.

To set the language for outgoing calls only

Select “Outgoing call”.

Select the guidance for outgoing calls from “Japanese/English”.

To set the language for incoming calls only

Select “Incoming call”.

Select the guidance for incoming calls from “Japanese/Japanese+English/English+Japanese”.

Service Dial

You can make a call to DoCoMo general information desk or service desk with quick operation.

● You cannot operate the service dial when you are in the area “” showed.

1 Select “Service dial”.

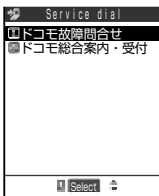

To make a call to DoCoMo service desk

Select “ドコモ故障問合せ”, and press  [Dial].

To make a call to DoCoMo general information desk

Select “ドコモ総合案内・受付”, and press  [Dial].

NOTE

● Service dials may not be available for some FOMA terminal versions.

Setting the Way to Handling Incoming Calls During a Call

You can set how to handle another incoming voice call during a call. This is useful if you have not subscribed to the “Call waiting” service. Select “Set arrival act” to “Activate” to set how to handle voice calls that come in while you are talking on the phone by using “Arrival call act” function.

- You cannot operate the “Set arrival act” where the “” icon is displayed.
- During a videophone call or 64K data communication, the function set in the “Arrival call act” becomes invalid.
- You can also manually connect a voice call received during a call to the voice mail service center or the forwarding destination.
- Relation between functions selected in the call waiting service, the set arrival act and the arrival call act are shown below.

Call waiting service subscription	Call waiting service	Set arrival act	Arrival call act						
			Voice mail	Call forwarding	Call rejection	Answer			
						Answer	Manual setting from the Function menu		
							Voice mail	Call forwarding	Call rejection
Not subscribe	—	Activate	○	○	○	※1	○	○	○
		Deactivate	×	×	×	×	×	×	×
Subscribe	Activate	Activate	※3	※3	※3	※2	○	○	○
		Deactivate	※3	※3	※3	※2	○	○	○
	Deactivate	Activate	○	○	○	※1	○	○	○
		Deactivate	×	×	×	×	×	×	×

○ : The function set in “Arrival call act” works.

× : The function set in “Arrival call act” does not work.

- ※1 : You are notified of another incoming call while you are talking, but you cannot answer the incoming call by putting the current call on hold.
- ※2 : You are notified of another incoming call while you are talking, and you can answer the incoming call by putting the current call on hold.
- ※3 : The “Voice mail”, “Call forwarding” or “Call rejection” are given priority and you cannot use the “Call waiting” service. “Answer” must be set.

- You cannot connect the incoming voice calls to the voice mail service center or the forwarding destination if you have not subscribed to “Voice mail” service or “Call forwarding” service.

Selecting the way to handle incoming calls during a call <Arrival call act>

Default setting

Answer

1

Select



“Arrival call act”.

2 Select the item you want to set.

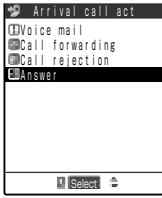

- Voice mail** : Connects an incoming voice call during a call to the voice mail service center regardless of the “Call waiting” or “Voice mail” service settings.
- Call forwarding**: Forwards an incoming voice call during a call to the forwarding destination regardless of the “Call waiting” or “Call forwarding” service settings.
- Call rejection** : Rejects an incoming voice call during a call.
- Answer** : When the “Call waiting” is set to “Activate”, the operations of the “Call waiting” are available. When the “Call waiting” is set to “Deactivate”, any of the following operations is available.
- You can take an incoming voice call by ending the current voice call.
 - You can connect an incoming voice call during a call to the voice mail service center or the forwarding destination or reject it by manually using the function menu. →p.75
 - When the “Voice mail” service or “Call forwarding” service is set to “Activate”, the settings in these services are followed.

NOTE

- When “Voice mail”, “Call forwarding” or “Call rejection” is set for this function, an incoming voice call during a call is recorded in the “Received calls” and the “Missed call” desktop icon appears on the standby display.

Activating the set arrival act

<Set arrival act>

Default setting Deactivate

1 Select   “Set arrival act”.

2 Select “Activate”.



To stop the set arrival act settings

Select “Deactivate”.

To check the set arrival act settings

Select “Check setting”.

Ending the current voice call to take another voice call

If you set “Arrival call act” to “Answer” and “Set arrival act” to “Activate”, you can take an incoming voice call by ending the current voice call.

1 When you hear a secondary call signal, press .

The current call ends and the ring tone sounds.

When the “Voice mail” service or “Call forwarding” service is set to “Activate”, and the ringing time has elapsed while a secondary call signal is sounding, the incoming call is connected to the voice mail service center or forwarding destination.

2 Press or [Talk].

You can receive a voice phone call.

Manually connecting to the voice mail/call forwarding service or rejecting calls

- When you receive another call while taking another, you can connect the new incoming voice call to the voice mail service or call forwarding service or reject the call in the following settings:
 - When the “Call waiting” is “Activate” and the Arrival call act is “Answer”.
 - When the set arrival act is “Activate” and the Arrival call act is “Answer”.
- Regardless of the Activate/Deactivate setting of the “Voice mail” service or “Call forwarding” service, you can use these services by using this function.

<Example: When the call waiting service is activated>

1 When you hear a signal tone during a call, press [FUNC] to display the function menu.

2 Select how you want to handle the incoming call.



To reject an incoming call

Select “Call rejection”.

To forward an incoming call to the forwarding destination

Select “Call forwarding”.

To connect an incoming call to the voice mail service center

Select “Voice mail”.

In any of the above cases, you can resume talking with the first caller.

NOTE

- If the call forwarding destination is not stored, a message saying “Forwarding number is not set” will appear.
- During a call to emergency numbers “110 (police)”, “119 (fire or ambulance)” or “118 (emergency number for maritime accidents)”, you cannot operate from the function menu.
- When you are not receiving a call (when you are out of the service area, you cannot answer a video/ videophone call or the power is off), the “Activate/Deactivate” setting of the “Voice mail” service or “Call forwarding” service is followed.

Controlling Network Services Remotely

You can operate network services such as the voice mail service and the call forwarding service by remote control using other phones such as pay phones.

- You cannot operate the remote control when you are in the area “” showed.

Activating the remote control

1 Select   “Remote control”.

2 Select “Activate”.



To stop the remote control
Select “Deactivate”.

To check the remote control settings
Select “Check setting”.

About controlling network services remotely

To operate network services from a phone, such as a pay phone, dial as follows:

090-310-XXXX

- For XXXX, dial the item that you want to operate.
- For details about operating method, refer to 『FOMA Network Services User's Guide』.

Additional service

Storing a New Service

When DoCoMo provides new network services, you can store up to 10 of these additional network services in your menu.

When a new network service is provided, a “Enter number” or a “Service code” to be used for the service will be sent to you. Register the “Special number” or “Service code” as well as the new service’s name on your FOMA terminal.

- You can register up to 10 network services.
- Enter the “Service code” into “USSD” in the Additional service entering display.
- When using the newly registered network service in “Service code (USSD)”, you can also record the answer message for the command sent from the network.

Storing a new service

1 Select   “Additional service”.

2 Select “Additional service”.



3 Highlight the <Not stored> and select “Add new service” from the function menu.



To Change the setting

Highlight the registered service and select “Edit” from the function menu.

4 Enter the service name.

Up to 10 full-pitch or 20 half-pitch characters can be entered for a service name.
Entering characters →p.300

5 Select the connect way.

To connect with the “Enter number”

Select “Enter number” and enter the special number.

To connect with the “Service code”

Select “Enter USSD number” and enter the service code.

Using a stored service

1 Select   “Additional service”.

2 Select “Additional service” to select the service number you want to use, and then press  [Send].

Storing an additional guidance

When using the newly registered network service in “Service code (USSD)”, you can store an answer message for the command sent from the network.

- You can register up to 10 answer messages.

1 Select   “Additional service”.

2 Select “Additional guidance”.

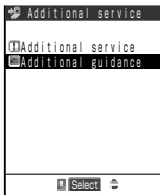

3 Highlight <Not stored> and select “Add new guidance” from the function menu.



To Change the setting

Highlight the registered service and select “Edit” from the function menu.

4 Enter the command.

Up to 20 digits of command can be entered.

5 Enter the additional guidance.

Up to 10 full-pitch or 20 half-pitch characters can be entered for an additional guidance.
Entering characters →p.300

Deleting a stored service or additional guidance

1 Select “Additional service”.

2 Select the item you want to delete.



To delete a stored additional service
Select “Additional service”.

To delete a stored additional guidance
Select “Additional guidance”.

3 Highlight the item you want to delete and select “Delete this” from the function menu.



To delete all items
Select “Delete all” from the function menu.



● Entering Characters

About Character Entry

You can use the dial keys on the FOMA terminal to enter characters. You need character entry when using “Mail”, “Add to phone book”, “Text memo” and other functions. Learn how to enter characters beforehand.

The following contents are described in terms of character entry:

About the character entry screen

This section describes marks displayed in the character entry area in the character entry screen and icons displayed in the guidance area. →p.301

Character entry in 5-touch

“5-touch (Mode1)” is a method for entering the characters assigned to a key by pressing that key the correct number of times. This character input method is the default setting. This section describes how to enter kanji, hiragana, katakana, alphabets, numbers, symbols, pictographs, face symbols, common phrases, lower case characters, spaces, line feeds and others, to switch full-pitch/half-pitch characters, lower case/upper case characters, insertion mode/overwriting mode and to enter characters using the Prediction function and Kuten code in this input method. →p.303

Copying/Cutting/Pasting characters

This section describes how to copy or cut characters within the area selected in the character entry screen, and then paste them to another place. →p.319

Dictionary/Common phrases

This section describes how to store frequently used words into the own dictionary, to use dictionaries for Japanese text conversion downloaded from sites such as i-mode sites and to store common phrases. Storing dictionaries or common phrases beforehand makes your character entry easier. →p.321, p.323 and p.324

Setting a character input method

This section explains changing the input method, setting Prediction and Guidance, setting T9 change mode, hiragana - kanji conversion, T9, and resetting the Prediction data. At the time of purchase the default is set so you can use both Prediction and Guidance. →p.326

T9 input

“T9 (Mode 3)” is an input method in which you only need to press the keypad with the desired character once to show a list of reading candidates from which you can choose. Here, there are more details about the basic input method and reading editing method using “T9 (Mode3)”.

→p.332

2-touch input

“2-touch (Mode 2)” is an input method in which you enter the assigned 2-digit number on the keypad for that character. Here, there are more details about the basic input method of

“2-touch (Mode 2)”. →p.336

Switching the screen

This section describes how to switch between the operation screen of functions and the character entry (edit) screen while these 2 screens are being displayed. Both screens are displayed only if you perform reply with reference to received mail or perform reference entry of a schedule from a received mail or i-mode screen. →p.338

About the character entry (edit) screen

The character entry (edit) screen comprises the character entry area, operation guidance area and information display area. The character entry area displays characters that you are entering, the cursor and end mark. The operation guidance area shows contents you can operate at that time, such as kanji conversion, search and area selection. The information display area indicates information including the character input method, input mode and remaining number of characters you can enter.



Character entry area

- : Cursor. A character is entered here.
- : End mark. You can enter characters up to this position. The end mark position varies with functions.

Operation guidance area

- CHG : Displayed when you can press to convert characters. →p.303
- All Find : Indicates that you can search the phonebook in the phonebook search screen by pressing . →p.116
- Fix mode Fix End : Indicates that you can use the fix input mode in Mode 3 (T9). →p.335
- Area : Shown when you copy (or cut) text. →p.319
- L/U : Indicates that you can switch the entered character between upper case and lower case by pressing . →p.304
- CR : Indicates that you can insert a line feed mark by pressing and holding down for 1 second or more. →p.309
- Back : Reverses the order of the input and goes back to the previous reading in the "Mode 1 (5-touch)" every time [Home] is pressed.

Information display area

- / : Displayed when the character input method is "Mode 3 (T9)" (p.332) or "Mode 2 (2-touch)" (p.336). Nothing appears here in "Mode 1 (5-touch)".
- : Displayed when "Fix mode" is set in Mode 3 (T9). →p.335
- / : Indicates "INS" in the insertion mode or "OVR" in the overwriting mode. →p.305
- / / : Indicates the current character input mode when the input mode is "Mode 1 (5-touch)" or "Mode 3 (T9)".
- : Displayed when it is "Kuten input mode". →p.316
- / : Indicates "Full-pitch" when you are entering a full-pitch character, and "Half-pitch" when entering a half-pitch character. →p.304
- : Displayed when you are entering a lower case character. →p.304
- : Indicates the remaining number of characters you can enter in bytes. The number of characters is counted as 1 byte for a half-pitch character and 2 bytes for a full-pitch character. Therefore, a full-pitch character corresponds to 2 half-pitch characters.
- : Indicates the number of characters you have entered while you are performing the phonebook storing into the FOMA card or entering body text in SMS. It does not distinguish between full-pitch and half-pitch characters.

NOTE

- You can also set the screen not to display the operation guidance. →p.329

Entering Characters in 5-touch

This section describes the basic character entry procedure in “5-touch (Mode 1)”.

Switching mode

In the character entry screen, you can switch the input mode, full-pitch/half-pitch, lower case/upper case characters, insertion mode/overwriting mode. Switch each mode depending on the situation.

Switching the input modes

The input modes in “Mode 1 (5-touch)” include “Alphabet input mode”, “Number input mode”, “Kanji/hiragana input mode” and “Kana input mode”.

Each time you press  [Mode], the input mode changes in order.

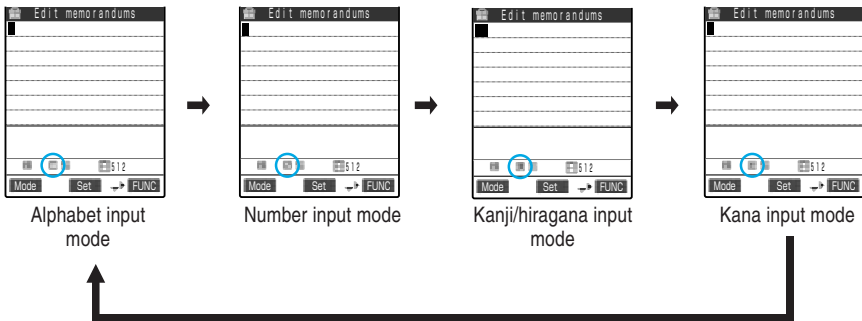

Alphabet input mode

Enters half-pitch or full-pitch alphabets and symbols. “” appears in the information display area.

Number input mode

Enters half-pitch or full-pitch numbers and symbols. “” appears in the information display area.



Kanji/hiragana input mode

Enters kanji, hiragana, katakana, symbols and numbers. Every character becomes full-pitch. “” appears in the information display area.

Kana input mode

Enters half-pitch or full-pitch katakana and symbols. “” appears in the information display area.

Switching between full-pitch and half-pitch

To switch between full-pitch and half-pitch, select “Full pitch” or “Half pitch” from the function menu. When you switch to “Full pitch”, “” appears in the information display area and when switching to “Half pitch”, “” appears.

In “Kanji/hiragana input mode”, you cannot switch between the full-pitch and the half-pitch.

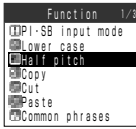

Full-pitch mode

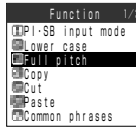

Half-pitch mode

Switching between lower case and upper case characters

There are two methods to switch between lower case and upper case characters.

Select from the function menu

Select “Lower case” or “Upper case” from the function menu. When you switch to “Lower case”, “” appears in the information display area. Nothing appears in “Upper case”.

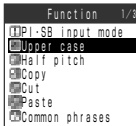

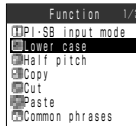

Lower case



Upper case

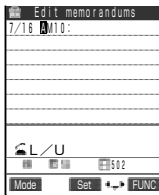
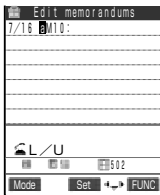

Press

Each time you highlight the character you want to switch, pressing , the character switches between lower case and upper case character. You can switch only if “L/U” is displayed in the operation guidance.



Switching between insertion mode and overwriting mode

When you enter a character in “Insert”, the new character is inserted between the characters already entered. When you enter a character in “Overwrite”, the character already entered is overwritten with the newly entered character.

To switch between the insertion mode and the overwriting mode, select “Insert” or “Overwrite” from the function menu. When you switch to “Insert”, “” appears in the information display area and when you switch to “Overwrite”, “” appears.

When you display the character entry (edit) screen, it is always set to the insertion mode.



Insertion mode



Overwriting mode

NOTE

- When you have already entered the permitted amount of text in “Insert”, you will not be able to input any more text.
- If you have already entered the maximum number of characters in the “Overwrite mode”, you cannot enter a full-pitch character overwriting half-pitch characters.

Entering characters

This section describes how to enter hiragana, kanji, katakana, alphabets and numbers in “5-touch (Mode 1)”.

- Overview of the keypad character assignments (5-touch Input) →p.340
- Complex kanji has been partially changed or omitted. Some alphanumeric characters and symbols are also partly changed.

Entering hiragana and kanji

After you enter hiragana, convert it to kanji in block units. You can also directly set the entered hiragana without converting to kanji.

- You can enter up to 20 characters (hiragana) for conversion and convert up to 6 blocks at a time.
- The kanji you can enter is 6355 characters of the JIS level-one and level-two kanji sets.

<Example: To enter “戸田俊司”>

1 Press  [Mode] to switch “kanji/hiragana input mode”.

Switching the input modes →p.303

2 Enter hiragana.

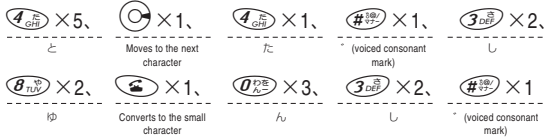

If you press the wrong key

Press to delete the character, and then press the correct key.

If you press the key wrong times

Press .

Return to the last reading assigned to the same key.

To enter characters assigned to the same key successively

Press , or hold down the key for 1 second or more.

The cursor moves, and then you can enter the next character.

To set the characters in hiragana

Press [Set].

3 Press to convert to kanji.



The kanji candidate in the first block is highlighted and the rest is underlined ().

If the desired kanji is given

Press [Set].

The kanji is set and the next block is highlighted.

To change the conversion range

Press or to change the conversion range, and then press .

The kanji candidate is changed according to the converted range. If there is no kanji available for that conversion range, hiragana is displayed instead.

4 Press or to display conversion candidates.

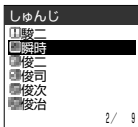

Conversion candidates for the highlighted block are listed. Hiragana and katakana are also shown as conversion candidates.

If reading characters for the conversion range are all in “あ” column

Numbers are also displayed as conversion candidates.

5 Select the desired kanji.

The kanji is set.

6 Press [Set].

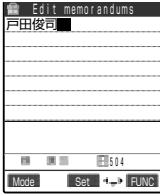

The entered character is set and the screen returns to the edit screen for each function.

NOTE

- If the desired kanji is not given, you may display it by changing the reading to onyomi or kunyomi.
- Kanji consisting of 2 or more characters that do not convert at once should be converted individually.
- You can use kuten codes to enter kanji that you cannot convert. →p.316

Entering katakana

<Example: To enter “リ-タ” ->

1 Press [Mode] to switch to “Kana input mode”.

Switching the input mode →p.303

2 Enter katakana.



The entered characters are directly set.

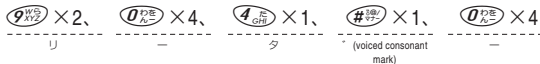

If you press the wrong key

Press  to delete the character, and then press the correct key.

If you press the key wrong times

Press .

Return to the last reading assigned to the same key.

To enter characters assigned to the same key successively

Press , or hold down the key for 1 second or more.

The cursor moves, and then you can enter the next character.

Entering alphabets

<Example: To enter “DoCoMo”>

1 Press [Mode] to switch to “Alphabet input mode”.

Switching the input mode →p.303

2 Enter alphabets.

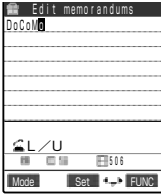

The entered characters are directly set.

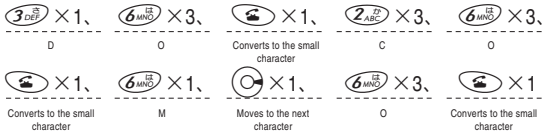

If you press the wrong key

Press **CLR** to delete the character, and then press the correct key.

If you press the key wrong times

Press **A**.

Return to the last reading assigned to the same key.

To enter characters assigned to the same key successively

Press **C**, or hold down the key for 1 second or more.

The cursor moves, and then you can enter the next character.

Entering numbers

<Example: To enter "11:30">

1 Press **[Mode]** to switch to "Number input mode".

Switching the input modes → p.303

2 Enter numbers.

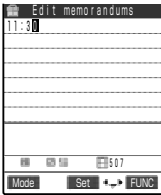

The entered characters are directly set.

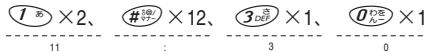

If you press the wrong key

Press **CLR** to delete the character, and then press the correct key.

To enter numbers assigned to the same key successively

Press the same key again.

Inserting a space (blank)

To insert a space (blank), select "Space" from the function menu. A full-pitch space is inserted in the full-pitch input or a half-pitch space is inserted in the half-pitch input.



Entering a line feed

You can enter the line feed mark “↵” to effect a line feed. There are two ways to enter the line feed mark “↵”.

The line feed mark is counted as a full-pitch character.

Entering from the function menu

Move the cursor to the position you want to enter a line feed and select “Line feed” from the function menu. The line feed mark “↵” is entered and the cursor moves to the next line.

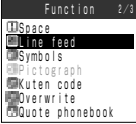

Holding down for 1 second or more

Move the cursor to the position you want to enter a line feed and hold down  for 1 second or more. The line feed mark “↵” is entered and the cursor moves to the next line.



NOTE

- The line feed mark can be deleted or overwritten just like any other character.
- You cannot enter the line feed mark in some i-mode text boxes.

Using prediction to enter text

Prediction is a function to display predictive and historical candidates based on the characters you have entered previously. When you enter the reading for a character, the FOMA displays predictions (predictive candidate) based on characters you have entered previously for what may follow from the entered text. In addition, when you set the entered text, the FOMA displays the text (historical candidates) that has followed that text in the past. It is useful for entering the desired text without entering all the characters manually.

- You can use the Prediction in “Kanji/Hiragana input mode” in “Mode 1 (5-touch)” and “Mode3 (T9)” and in “Full pitch input mode” in “Mode 2 (2-touch)”.
- For characters that have not been entered in the past, or if “Prediction” (p.328) is set to “OFF”, no candidates appear when you enter the reading.

1 Enter the reading.



Predictive candidates appear in the guidance area.

2 Slide or hold down for 1 second or more.



The cursor appears in the guidance area and you will be able to select the predictive candidate.

To return to entering the reading

Press .

If no predictive candidates are displayed or if none of the predictive candidates are suitable

Enter the text normally.

3 Select a predictive candidate.

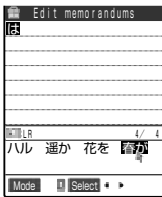

When you set the text, a historical candidate that follows the set text appears.



4 Select a historical candidate.



If no historical candidates are displayed or if none of the historical candidates are suitable

Enter the text normally.

NOTE

- When you perform “Clear learned” (p.331) of “T9/prediction”, predictive candidates and historical candidates in the “Prediction” will be deleted.
- If “Pointer” is set to “OFF” in “Neuropointer” (p. 251), hold down  for 1 second or more to make predictive candidates selectable.
- The common phrases beginning with a set character are also displayed as historical candidates.
- When DL dictionary is stored, the stored words in the dictionary are displayed for the predictive candidates.  is displayed for the candidates stored in the dictionary.

In addition to characters, you can enter pictographs and symbols in the character entry (edit) screen. Moreover, symbols and pictographs can be entered successively.

■ Entering symbols

You can enter symbols such as brackets, Greek numbers and units.

You cannot enter full-pitch symbols in the mail address storing screen, the destination entry screen for i-mode mail, or the URL entry screen.

1 Select “Symbols” from the function menu.



The candidates of symbols appear.

2 Select the symbol to enter.

List of symbols/special characters →p.343

■ Entering symbols and face symbols with character conversion

By entering the reading of symbols or face symbols and converting them in “Kanji/hiragana input mode”, you can enter the symbols corresponding to the reading.

■ Entering symbols

When you enter “きごう” and convert it in “Kanji/hiragana input mode”, the symbol candidates appear. In addition, you can enter symbol names such as “かっこ”, “さんかく” and convert them to enter the symbols.

Symbols in Japanese Conversion →p.344

■ Entering face symbols

When you enter “かお” or “かおもし” and convert it in “Kanji/hiragana input mode”, the face symbol candidates appear. You can also enter the meanings of the face symbols such as “ありがとう”, “さよなら” and convert them to enter the face symbols.

Face symbols →p.345

Entering pictographs

You can enter pictographs such as faces, weathers, animals in the character entry (edit) screen for mail texts, text memos and common phrases.

1 Select “Pictograph” from the function menu.



The pictograph candidates appears.

2 Select a pictograph to enter.

List of pictographs →p.344

Entering symbols or pictographs continuously

You can continue to enter symbols or pictographs by displaying the candidate screen for the symbols or the pictographs until you close the candidate screen. It is useful because you do not need call items from the function menu whenever you enter.

Refer to p.343 for available symbols and p.344 for pictographs.

1 Select “PI•SB input mode” from the function menu.

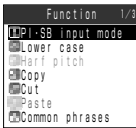

The candidates from pictograph 1 appear in the guidance area. “Current page/total pages” is displayed at the upper-right in the guidance area.

2 Press [PI•SB] to switch the candidate screen.

The candidate screen turns to “Pictograph 1” - “Pictograph 2” - “Full pitch 1” - “Full pitch 2” - “Half pitch” in order each time you press .

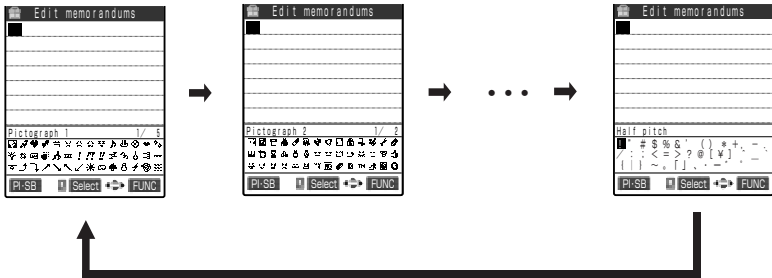

3 Select a symbol or pictograph to enter.

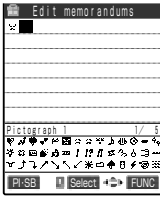

The selected symbol or pictograph is entered. You can continue to enter other symbols or pictographs directly.

4 Press when you complete the entry.

The continuous entry of pictographs and symbols ends.

Entering common phrases

In the character entry (edit) screen, you can enter pre-stored common phrases. The common phrases include pre-stored “preset common phrases” and “own common phrases” which can be stored by yourself.

- The common phrases can be entered in the following character entry (edit) screens.
 - Text memo
 - Common phrase
 - Folder name of common phrase
 - Schedule
 - ToDo
 - Wake-up message
 - i-mode mail subject
 - i-mode mail text
 - i-mode mail header
 - i-mode mail signature
 - Quotation mark for i-mode mail
 - Reply with reference to i-mode mail
 - Subject for Auto-sort setting
 - Subject for Search mail
 - Text editing in an i-mode text box
 - Text editing with i-appli
 - Dictionary
- For creating and editing common phrases, see p.324.
- About the fixed common phrases, see p.346.

1 Select “Common phrases” from the function menu.



2 Select a folder.



To enter “preset common phrases”
Select folder 1 through 2.

To enter “own common phrases”
Select folder 3 through 5.

3 Select a common phrase to enter.



The detailed screen of the common phrase appears.

4 Press [Select].

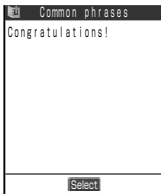

The selected common phrase is entered.

NOTE

- If the total number of characters in the common phrase exceeds the permitted limit as you enter it, a message notifying you that the number of characters exceeds appears. If you select “YES”, the common phrase is entered and the characters exceeding the limit are deleted from the end of the text.
- You cannot enter any common phrases if you have already entered the maximum amount of text.
- You can enter the common phrases as conversion candidates of the Prediction function (p.309). In this case, conversion candidates stored as the common phrases are displayed with “”.

Quoting phonebook data and own number data

You can quote names, readings, telephone numbers, mail addresses, street addresses, and memos stored in “Phonebook” and “Own number” in the character entry (edit) screens such as mail text and “Text memo”.

- You cannot quote data in some character entry (edit) screens.

1 Select “Quote phonebook” or “Quote own number” from the function menu.



If you select “Quote phonebook”
 Select “Group search” or “Column search” to search the phonebook you want to quote.
 Searching the Phonebook → p.116

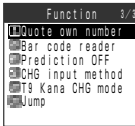

If you select “Quote own number”
 Enter your 4 though 8 digit security code.
 Security code → p.192

2 Select the item you want to quote.



When quoting the
 Phonebook

3 Press [Finish].

The selected item is entered.

NOTE

- If a string to be quoted includes a character that cannot be entered in its character entry (edit) screen, the character will be replaced with a half-pitch space.
- In character entry (edit) screens such as “Text memo” or “i-mode mail”, 2 half-pitch spaces are entered between quoted items. In character entry (edit) screens such as SMS message edit screen where a line feed can be entered, the line feed mark (↵) is entered for each quoted item.
- You cannot quote any text if you have already entered the maximum amount.

Using kuten codes to enter characters

You can enter kanji, hiragana, katakana, symbols, alphabetic characters (letters) and numbers using 4-digit kuten code.

- Select the following input mode based on your character input method before entering characters using kuten codes.

- Mode 1 (5-touch) : Kanji/hiragana input mode
- Mode 2 (2-touch) : Full-pitch input mode

You can switch input mode into kuten input method by function menu without setting above input mode.

- For kuten codes and characters that you can enter with kuten codes, refer to p.347.
- You can enter characters with kuten codes after the entered characters are set.

<Example: To enter “ ㄱ ” (kuten code 0814)>

1 Press .

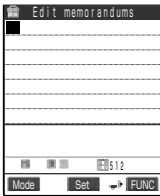

The input mode switches to “Kuten input mode” and “” appears in the information display area.

If the character input mode is “Mode 3 (T9)”
Select “Kuten code” from the function menu.

2 Enter a kuten code    .

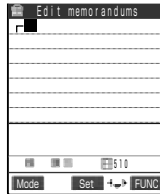
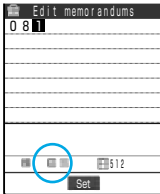

The character corresponding to the entered kuten code is entered and the input mode returns to the original mode.

If there is no character that corresponds to the entered kuten code

A space is entered.

NOTE

- Even if the character input method is “Mode 1 (5-touch)” or “Mode 2 (2-touch)”, you can enter characters by selecting “Kuten code” from the function menu.

Editing text

You can insert new characters or delete pre-entered characters to edit the text.

Inserting characters

Select "Insert" and then press  to move the cursor one character to the right of where you want to insert the characters. When you enter the characters, the characters are inserted to the left of the cursor.



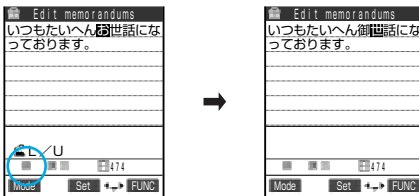

Overwriting characters

Select "Overwrite" and then press  to move the cursor to the character you want to overwrite. When you enter a new character, it overwrites the character in the cursor position.



Deleting characters

Press  to move to the character you want to delete, and then press  briefly (less than 1 second). The character in the cursor position is deleted.

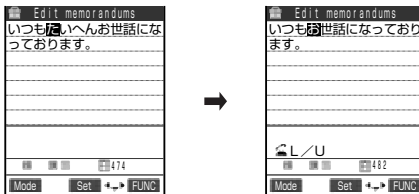

If there is no character on the cursor

The character to the left of the cursor is deleted.

If you hold down for 1 second or more

The characters in the cursor position and every one to the right of it is deleted.

When there is no character to the right of the cursor, if you hold down for 1 second or more

All the characters are deleted.

Jumping to the top or bottom of a message

You can easily jump the cursor up to the beginning or down to the end of your message in the character entry (edit) screen. It is useful for long messages such as mail texts and text memos.

1 Select “Jump” from the function menu.

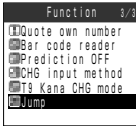

2 Select an item.



If you jump the cursor up to the beginning of the message
Select “To beginning”.

If you jump the cursor down to the end of the message
Select “To end”.

Protecting data being entered or edited

The entered characters do not disappear and remain even if the battery runs out or there is an incoming voice call while you are entering characters in the character entry (edit) screen.

When the battery runs out

If the low voltage alarm sounds while you are entering characters, the screen automatically changes to the message screen of “Recharge battery” from your character entry (edit) screen. The data being entered are automatically set and saved, so that you can re-enter the remaining characters after turning on the power again and calling up that function. However, in some functions, the entered data might not be saved. In addition, characters being converted and unset will not be saved.

Re-editing phonebook →p.114

When you press

If you press  while entering characters, a message will appear to ask if you finish entering your work. If no character has been entered, the message will not appear.

< To finish entering without saving the contents being entered >

Select “YES”. The data being entered are not saved and you will return to the previous screen or standby display.

You can also close the entry screen without saving the data by pressing .

< To continue editing >

Select “NO”. The entered data will be preserved intact and you return to the character entry (edit) screen.

You can also return to the character entry (edit) screen by pressing .

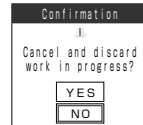

When there is a voice call

Even if receiving a voice call while you are entering text, you can answer the call while the text being entered is as it is. The character entry (edit) screen returns when the call finishes. During a voice call, you can also press  to display the task menu and return to the character entry (edit) screen while talking. →p.268



● Entering Characters

Storing Frequently Used Words

Default setting Not stored

If you store a frequently used word with your favorite reading, the stored word is displayed when you enter and convert the reading in the character entry (edit) screen. It is useful if you store words beforehand that are not displayed with standard conversion.

- You can store up to 100 items in your own dictionary.
- Up to 10 full-pitch or up to 20 half-pitch can be entered for each word. Up to 10 full-pitch characters of hiragana can be entered for each reading.
- The same word and reading cannot be stored.
- You cannot enter any pictograph, line feed or common phrase as words or readings. A space is automatically omitted before it is stored.
- You cannot store symbols (、 。 ・ ! ?) except for the voiced consonant mark and semivoiced consonant mark for readings.

Storing a new word

1 Select   "Own dictionary".

2 Select "New".





3 Enter the word.

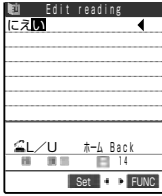

4 Enter the reading.



Checking the word contents

1 Select   "Own dictionary".

2 Select the word you want to check.

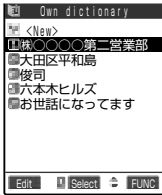

If you change the word contents

Highlight the word you want to change, and then press  [Edit].

To delete one word

Highlight the word you want to delete, and then select "Delete this" from the function menu.

To delete selected word

Select "Delete selected" from the function menu, and then select the words you want to delete.

To delete all words

Select "Delete all" from the function menu.

3 Check the contents.

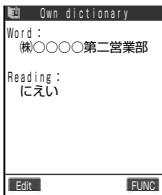



Setting the Dictionary to Use

Default setting

Not stored

You can download dictionaries from sites such as i-mode sites for use in Japanese text conversion and then specify the downloaded dictionaries to use for conversion. When you download and specify a dictionary of specialist terms, the specialist terms stored in the dictionary are displayed in the list of conversion candidates.

- You can store up to 5 download dictionaries and enable 2 of them.
- For how to download dictionaries, refer to p.115 in 『Application』.

1 Select   “DL dictionary”.

2 Select the dictionary you want to specify.

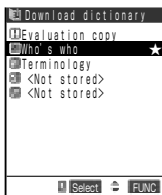

“★” is attached to the dictionary you have set.

To cancel the set dictionary

Select the dictionary with “★”.

The specification is canceled and “★” disappears.

To check information on the dictionary

Highlight the dictionary you want to check, and then select “Dictionary info” from the function menu.

To change the title of a dictionary

Highlight the dictionary you want to change, and then select “Edit title” from the function menu.

You can enter up to 10 full-pitch or 20 half-pitch in a title.

To delete a dictionary

Highlight the dictionary you want to delete, and then select “Delete this” from the function menu.

To delete all dictionaries

Select “Delete all” from the function menu.

NOTE

- If 2 download dictionaries have already been specified, a message notifying you that the dictionaries have already been specified appears. Cancel a dictionary with the “★”, and then set another dictionary again.
- If you set a title without entering any character when you edit the title of download dictionary, it returns to the previous title.
- If you insert no FOMA card or another FOMA card that is not used when downloading the dictionaries, you cannot use the dictionaries.

Creating and Changing Common Phrases

If you store common phrases beforehand, you can call and enter the phrases in the character entry (edit) screen.

Common phrases are stored in 5 folders. Folder 1 through 2 each contain 10 preset common phrases that have been pre-stored. You can edit the preset common phrases. Folder 3 through 5 are provided for storing up to 10 custom common phrases for each. You can also edit the folder names to sort the common phrases according to their purposes.

- You can store 10 common phrases in each folder, or total 50 common phrases.
- You can enter up to 64 full-pitch or up to 128 half-pitch in each common phrase.
- For contents of common phrases p.346.

Creating a new common phrase

1 Select   ► “Common phrases”.

2 Select a folder.



3 Select <Not stored> and press  [Edit].



4 Enter the common phrase.

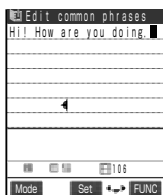

Changing common phrases

1 Select   ► “Common phrases”.

2 Select a folder.

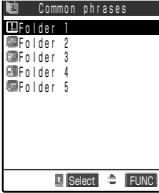

To rename a folder

Highlight the folder of which you want to change the name, and then select “Edit folder name” from the function menu.

You can enter up to 10 full-pitch or 20 half-pitch in the folder name.

To reset a folder name

Highlight the folder of which you want to reset the name, and then select “Reset name” from the function menu.

The folder name is reset to the default setting.

3 Select the item you want to change and press  [Edit].



To delete a common phrase

Highlight the common phrase you want to delete, and then select “Delete this” from the function menu.

To delete all common phrases in the folder

Select “Delete all” from the function menu.

4 Change the contents.



NOTE

- If you set a folder name without entering any character when editing the folder name, the folder name returns to the default setting.
- If you delete a preset common phrase, the contents return to the default setting.

Setting a Character Input Method

You can change the character input method used for entering characters and the settings for the Prediction function and Guidance.

Changing the character input mode

You can select 2 or more input methods used for entering characters and then specify one of those as your favorite method (Prior mode) to be used when you display the character entry (edit) screen. You can also switch the input methods while you are entering text.

There are 3 input methods as follows:

Input method	Feature	Entry example: おはよう
5-touch (Mode 1)	A method for entering the characters assigned to a key by pressing that key the correct number of times.	Press 1^{st} × 5, 6^{th} × 1, 3^{rd} × 3 and 1^{st} × 3.
2-touch (Mode 2)	A method for entering characters assigned to a 2-digit number by entering that 2-digit number with the keys, as if you send characters to QUICKCAST*	Press 1^{st} 5^{th} , 6^{th} 1^{st} , 3^{rd} 5^{th} and 1^{st} 3^{rd} .
T9 (Mode 3)	A method for entering characters by pressing the key of the column assigned to the character you want to enter once to display conversion candidates, and then selecting one from the displayed candidates. If you continue to press the key, the conversion candidates change depending on the contents.	Press 1^{st} , 6^{th} , 3^{rd} , 1^{st} and select “おはよう” from the conversion candidates.

Changing the input method before entering characters

You cannot select only one character input method.

1 Select   “Other settings” ▶ “Input method”.

2 Select “Input mode”.

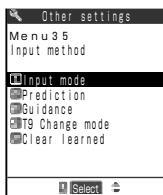

3 Select 2 or more input methods to use, and press [Finish].

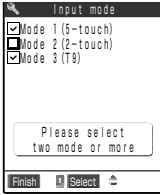

4 Select the character input method to be given priority.

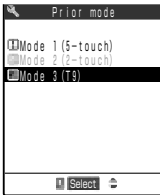

The character input methods which were not selected in Step 3. are not displayed.

Switching character input method while you are entering text

When the character entry (edit) screen appears, your preferred character input method is set. There are 2 ways to switch to another character input method in the character entry (input) screen.

The switching of the character input method is only effective in the current character entry (edit) screen. Once you finish your character entry, and display the character entry (edit) screen next time, the character input method will return to your preferred input method.

Switching from the function menus

Select “CHG input method” from the function menu to select the character input method you want to use.

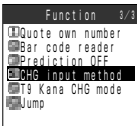

Hold down [Mode] for 1 second or more.

Each time you hold down “ [Mode]” for 1 second or more, the character input method changes to “Mode 1 (5-touch)”→“Mode 2 (2-touch)”→“Mode 3 (T9)” in turn.

NOTE

- You cannot switch to a character input method which was not selected in “Input mode” in “Input method”.
- You cannot switch the character input method in some character entry (edit) screen for specific items such as zip code entry.

* As of January 2001, the paging service provided by NTT DoCoMo is thereby known as QUICKCAST.

Selecting whether to use the Prediction

Default setting

ON

You can select to use or not to use Prediction function that displays predictive candidates and historical candidates based on the previously entered words. You can turn ON/OFF Prediction function even while you are entering text.

- You can use the Prediction in “Kanji/Hiragana input mode” in “Mode 1 (5-touch)” and “Mode3 (T9)” and in “Full pitch input mode” in “Mode 2 (2-touch)”.

Switching input mode before entering characters

1 Select   “Other settings”  “Input method”.

2 Select “Prediction”.

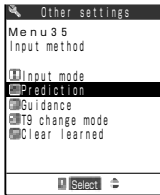

3 Select the item to set.

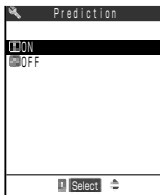

To use the Prediction function

Select “ON”.

Not to use the Prediction function

Select “OFF”.

Switching the Prediction function “ON/OFF” during character entry

When the character entry (edit) screen displays, the status of Prediction function is the same as you set in “Prediction” in “Input method”. To switch Prediction function On or Off in the character entry (edit) screen, select “Prediction OFF” or “Prediction ON” from the function menu. “Prediction OFF” appears when Prediction function is “ON”, and “Prediction ON” appears when the function is “OFF”.

The switching of Prediction function is only effective in the current character entry (edit) screen. Once you finish your character entry, and display the character entry (edit) screen next time, it will return to the status you set in “Prediction”.

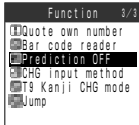



NOTE

- Any stored predictive candidates and historical candidate will not be deleted even when you switch Prediction function On or Off.

Selecting whether to display guidance

Default setting ON

You can select to display (ON) or not to display (OFF) the operation guidance in the character entry (edit) screen. When you set it to “OFF”, the operation guidance will disappear, so that you can use the character entry area wider.

1 Select   “Other settings”  “Input method”.

2 Select “Guidance”.

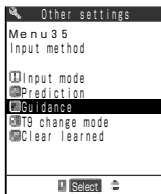

3 Select the item to set.

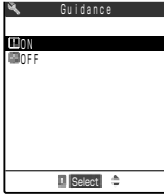

To display the operation guidance

Select "ON".

Not to display the operation guidance



Select "OFF".

Setting T9 Change Mode

Default setting | T9 Kanji change mode

When entering characters using the T9 method (p.332), you can choose to convert the entered characters to Kanji or Kana characters. You can switch T9 change modes even while entering characters.

■ Switching T9 change mode before entering characters

1 Select   "Other settings"  "Input method".

2 Select "T9 change mode".

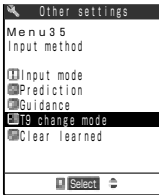

3 Select a desired item.



To convert the entered characters to Kanji characters

Select "T9 Kanji change mode".

To convert the entered characters to Kana characters

Select "T9 Kana change mode".

Switching T9 change modes while entering characters

Characters input on the Character input (edit) screen are converted to either Kanji or Kana characters depending on the setting in “T9 change mode” for “Input method”. To change the T9 change mode from the Character input (edit) screen, select “T9 Kanji change mode” or “T9 Kana change mode” from Function menu while the Kanji/Hiragana character input mode is selected. When “T9 change mode” is set to “T9 Kanji change mode”, “T9 Kana change mode” will be displayed. When “T9 Kana change mode” is set, “T9 Kanji change mode” will be displayed. In addition, switching the mode during character input is valid only for the current Character input (edit) screen. Therefore, after finishing the current character input and then displaying the new Character input (edit) screen, the setting will be in accord with the “Input method” setting.

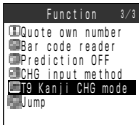

Resetting the learning record

You can reset the following learned data stored in your FOMA terminal:

- Learning record of 5-touch
- Learning record of “T9 (Mode 3)”
- Prediction function’s predicted candidates and historical candidates

1 Select   “Other settings”  “Input method”.

2 Select “Clear learned” and enter your security code.

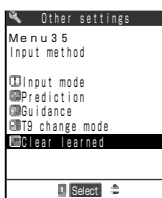

Security code →p.192

3 Select the items you want to delete.



To clear the learning record data stored with “Mode 3 (T9)” and the “Prediction”

Select “T9/Expect words”.

To clear the learning record data stored with “Mode 1 (5-touch)”

Select “Kana/Kanji change”.

Entering Characters in T9 (Mode 3)

“T9 (Mode3)” is an input method for entering characters by pressing the key of the column assigned to the character you want to enter once to display predictive conversion candidates, and then selecting one from the displayed candidates. If the input mode is “Kanji/hiragana input mode”, you can use “Prediction”. In addition, for cases where no conversion candidates that you want to enter appears there are the “Yomi edit mode” function for editing the candidate you entered, and the “Fix mode” function for directly entering the reading that you want to enter.

- For switching to “T9 (Mode 3)”, see p.326.
- For how to switch the full-pitch/half-pitch mode, lower case/upper case characters, and to enter symbols, pictographs, common phrases, see “Entering characters in 5-touch” (p.303).

Switching the input mode

“T9 (Mode 3)” can be used in “Kanji/hiragana input mode” and “Kana input mode”. When the FOMA is in “Alphabet input mode” and “Number input mode”, the input modes in “5-touch (Mode 1)” (p.305) are used. Each time you press , the input mode changes in turn.

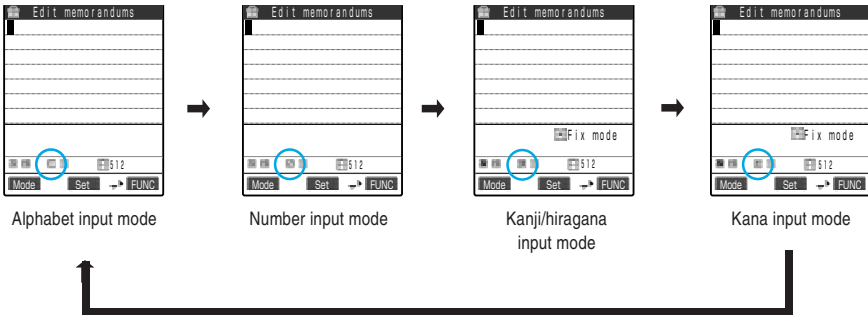

■ Alphabet input mode

Use “Mode 1 (5-touch)” to enter half-pitch or full-pitch alphabets and symbols. “” appears in the information display area.

■ Number input mode

Use “Mode 1 (5-touch)” to enter half-pitch or full-pitch numbers and symbols. “” appears in the information display area.

■ Kanji/hiragana input mode

Use “Mode 3 (T9)” to enter kanji, hiragana, katakana, symbols and numbers. Entered character are all full pitch. “” appears in the information display area.

■ Kana input mode

Use “Mode 3 (T9)” to enter half-pitch or full-pitch katakana, symbols and numbers. “” appears in the information display area.

Entering characters

This section describes how to input text using “T9 (Mode 3)”.

● List of character assignment in T9 (Mode 3) → p.341

<Example: To enter “戸田” in T9 Kanji change mode>

1 Press  [Mode] to select “Kanji/hiragana mode”.

2 Enter the characters you want to convert.



 (た column),  (た column),  (voiced consonant mark)

The reading candidates are displayed by analogy with “た^ん”.

If you press a wrong key

Press  to delete the character, and then press the correct key.

If entered characters exceed the recognition area

As the characters exceeding the recognition area are grayed out, press  to change the area of the conversion candidate.

To change the conversion candidate (Kanji/Kana) display

Press .

To display conversion candidates for word prediction

Press and hold down  longer than 1 second.



Press  to return to the regular conversion candidate display.

3 Slide  or press  to select the conversion candidate.



The selected conversion candidate appears in the character entry area.

If you set “Pointer” to “OFF” in “Neuropointer”

Press  to highlight the conversion candidate and then press  to select the conversion candidate.

To return to the entry of characters to be converted

Press .

To directly convert to characters outside of the displayed conversion candidates

Press  [CHG] →  to select the candidate.

NOTE

- If you change the area of the character conversion to divide into multiple blocks, each block is stored as one word.
- You can change to Kanji by pressing  even after selecting the conversion candidate for Kana in “T9 Kana change mode”.
- When you enter readings in “Add to phonebook” in the FOMA card, or enter readings in “Own dictionary”, no number appears as conversion candidate.
- If the downloaded dictionary is stored, words stored in the dictionary are displayed as conversion candidates.

Editing the conversion list





If displayed conversion candidates do not include the candidate you want to enter, you can edit a candidate. If it does not contain a voiced consonant mark or semi-voiced consonant mark, the edited candidate will be displayed as the first candidate at the next entry.

<Example: To change conversion candidate from “らわらわた” to “爛々と”>

1

Enter the characters you want to convert.



 (ら column),  (わ column),  (ら column),
 (わ column),  (た column)

The conversion candidates that can be analogize with “らわらわた” appears. In that case, the candidate “らんらんと” is not displayed.

2

Press  [Yomi].

The candidate edit mode is set and the cursor moves to the beginning of the candidate. The characters of “ら column” appear in the display area for the conversion candidates.

3

Press the dial key corresponding to the number of the desired character.

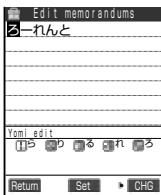

In this example, press  (ら).

When you edit the character, the cursor moves to the next character. Edit the candidate in the same manner.

If you do not change the conversion candidate

Press  to move the cursor to the character you want to edit next.

To finish editing on the way

Press  [Return].

The characters you have changed until finishing appear as a conversion candidate.

4 Slide or press to select “爛々と”.



If you enter “らわらわた”, “爛々と” will be displayed at the top of the list of conversion candidates from the next time onward.



Enter the conversion candidates with the fixed input

If you anticipate that the characters you want to enter will not appear in the conversion candidates, you can directly enter that reading in the fixed input mode. In this case, conversion candidates from the Prediction function are displayed when the second character of the word is entered.

<Example: To enter reading “はためく”>

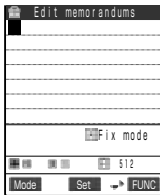
1 Press (Fix mode).





The fixed input mode is set and the “” in the information display area changes to “”.

2 Press the key of the column assigned to the character you want to enter.

In this case, press . The characters in “は column” appear in the display area for conversion candidates.

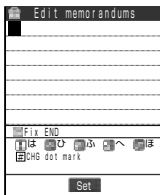
3 Press the dial key corresponding to the number of the desired character.





In this case, press  (は).
Enter the reading in the same manner

4

Press  (Fix END) and then  [Set].



Press  (Fix END) to display the conversion candidates. You can then convert the word to kanji, hiragana or katakana by pressing .

Entering Characters in 2-touch (Mode 2)

“2-touch (Mode 2)” is a method for entering characters assigned to a 2-digit number by entering that 2-digit number with the keys. The operation is the same as you send characters to a QUICKCAST*.

- For switching to “2-touch (Mode 2)”, see p.326.
- For how to switch the full-pitch/half-pitch mode, lower case/upper case characters and to enter symbols, pictographs, common phrases, refer to “Entering characters in 5-touch” (p.303).

Changing the input mode

There are “Full-pitch input mode” and “Half pitch input mode” for “2-touch (Mode 2)”. The input mode switches between the two modes each time you press  [Mode].

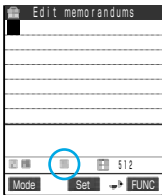

Full-pitch input mode

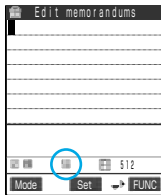

Half-pitch input mode

■ Full-pitch input mode

You can enter full-pitch kanji, hiragana, katakana, alphabets, numbers, symbols and pictographs. “” is displayed in the information display area.

■ Half-pitch input mode

You can enter half-pitch katakana, alphabets, numbers, symbols and pictographs. “” is displayed in the information display area.

NOTE

- When you enter readings in “Add to phonebook” in the FOMA card, you can enter only katakana in “Full-pitch input mode”.

Entering characters

This section describes how to input text using “2-touch (Mode 2)”.

- List of character assignment in “2-touch (Mode 2)” → p.342



<Example: To enter “はる”>

1 Press  [Mode] to switch to “Full-pitch input mode”.

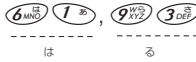
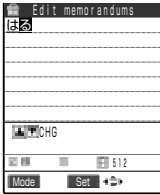
2 Enter the characters.



NOTE

- In “Mode 2 (2-touch)”, you can switch between the “Lower case input mode” and the “Upper-case input mode” by pressing  .
- You may not enter characters in “2-touch (Mode 2)” for some functions. In that case, use “5-touch (Mode 1)” to enter characters.

Switching the Screen to Operate

The character entry (edit) screen appears over the original menu function screen when you perform reply with reference from received mail or reference entry of a schedule from a received mail or the i-mode screen, so that you can edit while viewing contents in the original menu function screen. When you finish replying with reference from received mail or storing a schedule, the original menu reappears.

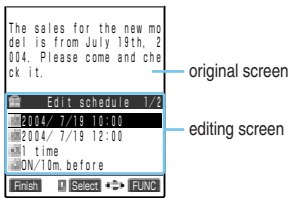

Reference entry of a schedule from the i-mode screen

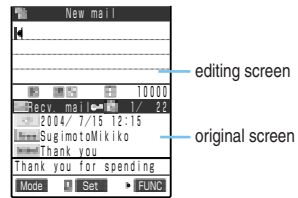



Reply with reference from received mail

- You cannot enter characters in the character entry (edit) screen while you are operating the original menu function screen.
- For the reply with reference, refer to p.188 in 『Application』.
- To store a schedule, referring to received mail, select “Store schedule” from the function menu in the received mail (p.185 in 『Application』) details screen.
- For the schedule, refer to p.216.

How to switch the screen to operate

When the character entry (edit) screen appears over the original menu, you can switch the screen to operate. To switch the operation screen, the following three ways are available.

- **Holding down**  **for 1 second or more**
Each time you hold down  for 1 second or more, you can switch the screen to operate.
- **Using the pointer to select screen to operate**
Slide the Neuropointer key to display the pointer, and then select the screen you want to operate.
- **Selecting from the function menu**
When you select “Change window” from the function menu, the screen to operate switches.

NOTE

- Even if you switch the screen to operate, the entered characters and cursor position remains the same as before switching.
- You cannot switch the operation when reading is being entered.
- If you switch the operation to a received mail or i-mode screen while the edit screen is displayed, you can only scroll the screen. However, you can copy and change the font size for a received mail only.



● Appendix

Glossary

For the terms used in this manual, refer to the following:

- **DTMF**
Standing for Dual Tone Multi Frequency, it is a sound that you hear every time you press a keypad in push phones, etc. It is also called push signal, push sound or tone signal. The signal may not be received depending on the device of the other party.
- **PIM**
Personal Information Manager program such as “Phonebook”, “Schedule”, “Text memo”, “Own number”, “Bookmark” and “Mail”.
- **PIN1 code and PIN2 code**
The PIN1 code and PIN2 code are 4- to 8-digit numbers (codes) to prevent any unauthorized use of the FOMA card.
The PIN1 code is a security code to be entered to verify a user when the FOMA terminal is turned on.
The PIN2 code is a 4- to 8-digit security code to be entered when user authentication is required for online services such as accessing to a site or the Internet. This FOMA terminal uses the PIN2 code when you connect to the FirstPass center during the user certificate operation or access to sites compatible with the FirstPass. →p.49 in 『Application』
- **PUK code**
An 8-digit number required for canceling the PIN1/PIN2 code lock.
- **Byte**
A unit of the amount of data. A half-pitch character is 1 byte and a full-pitch character is 2 bytes. With a FOMA terminal, the remaining number of characters that can be entered on the character entry screen is displayed in bytes. However, the SMS compose message screen displays the number of characters entered on the screen. “K” (kilo), “M” (mega) and other expressions are also used with byte; 1,024 bytes is equal to 1 KB and 1,024 KB to 1 MB.

Overview of the Keypad Character Assignments (5-touch Input)

Key	Kanji/Hiragana input mode	Katakana input mode	Letter input mode	Number input mode
1 あ	あいうえお あいうえお	アイウエオ アイウエオ	? ! - / ¥ & * () # ° ☎ *1	1
2 あ	かきくけこ	カキクケコ	A B C a b c	2
3 あ	さしすせそ	サシスセソ	D E F d e f	3
4 あ	たちつとつ	タチツテトツ	G H I g h i	4
5 あ	なにぬねの	ナニヌネノ	J K L j k l	5
6 あ	はひふへほ	ハヒフヘホ	M N O m n o	6

7 P p R R G G S S	まみむめも	マミムメモ	PQRS p q r s	7
8 T t U u V v	やゆよやゆよ	ヤユヨヤユヨ	TUV t u v	8
9 W w X x Y y Z z	らりるれろ	ラリルレロ	WXY Z w x y z	9
0 W w	わをんーわ	ワヲンーワ ^{*2}	—————	0
* H h M m	————— ^{*3}	—————	.ne.jp .co.jp .ac.jp ^{*4} www. .com .html http:// https:// @docomo.ne.jp	* .ne.jp .co.jp .ac.jp ^{*4} www. .com .html http:// https:// @docomo.ne.jp
# #	°、°、°、° ! ? ^{*5}	°、°、°、° ! ? ^{*5}	.@ / ! ? () , - _ : ; ~ ^{*6} & ¥	# .@ / ! ? () , - _ : ; ~ ^{*6} & ¥

※1： Valid only when entering SMS text. Though you cannot enter “Pictograph” when entering SMS text, “Ⓐ” and “Ⓑ” can be entered. In addition, characters such as “Ⓐ” and “Ⓑ” are always displayed as full-pitch characters while symbols are displayed as half-pitch characters.

※2： The lower case character of “ワ” can only be entered when the full-pitch input mode is used.

※3： Pressing (M) while you are in “Kanji/hiragana input mode” changes the input mode to “Kuten input mode” (p.316).

※4： Not displayed when the input mode is changed to a full-pitch input mode (Except for “*” in Number input mode).

※5： “°” and “°” are displayed only when you are in “Kanji/hiragana input mode” or “Katakana (full-pitch) input mode”, and if “°” and “°” can be prefixed to the characters entered. The characters “、”、“°”、“°”、“°”、“°”、“°”、“°” cannot be used when you enter the reading of words in your own dictionary (p.321) or when you enter the reading of words in the phonebook for the FOMA card (p.111).

※6： Becomes a “—” when you are in “Full-pitch input mode”.

■： Lowercase characters can be entered in following two ways:

- Enter an uppercase character first and then press (C) to change it to lowercase.
- Select “Lowercase” first from the function menu and then enter the character.

Overview of the Keypad Character Assignments (T9 Input)

Key	Kanji/hiragana input mode	Katakana input mode
1 あ	あ column, 1	アcolumn, 1
2 か	か column, 2	カcolumn, 2
3 さ	さ column, 3	サcolumn, 3
4 た	た column, 4	タcolumn, 4
5 な	な column, 5	ナcolumn, 5
6 は	は column, 6	ハcolumn, 6
7 ま	ま column, 7	マcolumn, 7
8 や	や column, 8	ヤcolumn, 8
9 ら	ら column, 9	ラcolumn, 9
0 わをんわー	わをんわー, 0	ワヲンワ ^{*3} —, 0
#	※1、※2	※1、※2

- Refer to the Keypad Character Assignments “5-touch input (Mode 1)” for key assignment for “Letter input mode” and “Number input mode”. →p.340
- Numbers are not displayed as candidates when entering a reading during an addition to a FOMA card phonebook or on “Own dictionary”.





※1： Candidates with “°” and “°” (dakuten and handakuten) are switched during reading entry.

※2： After readings or characters have been confirmed, “°”、“°”、“°”、“°”、“°”、“°”、“°”、“°” are displayed in the same way as “5-touch (Mode 1)”. “°” and “°” (“dakuten” and “handakuten”) are displayed only when the characters entered can take a “°” and “°”.





※3： The lower case character of “ワ” can only be entered in full-pitch input mode.

Overview of the Keypad Character Assignments (2-touch Input)







■ Full-pitch input mode

Key	2nd key input										
	1	2	3	4	5	6	7	8	9	0	
1st key input	1	あ	い	う	え	お	A	B	C	D	E
		ぁ	ぃ	ぅ	ぇ	ぉ	a	b	c	d	e
	2	か	き	く	け	こ	F	G	H	I	J
						f	g	h	i	j	
	3	さ	し	す	せ	そ	K	L	M	N	O
							k	l	m	n	o
	4	た	ち	つ	て	と	P	Q	R	S	T
							p	q	r	s	t
	5	な	に	ぬ	ね	の	U	V	W	X	Y
							u	v	w	x	y
6	は	ひ	ふ	へ	ほ	Z	?	!	—	/	
						z					
7	ま	み	む	め	も	¥	&				
8	や	(ゆ)	よ	*	#				
	ゃ		ゅ		ょ						
9	ら	り	る	れ	ろ	1	2	3	4	5	
0	わ	を	ん	ゝ	ゞ	6	7	8	9	0	
	わ										

■ Half-pitch input mode

Key	2nd key input										
	1	2	3	4	5	6	7	8	9	0	
1st key input	1	ア	イ	ウ	エ	オ	A	B	C	D	E
		ァ	ィ	ゥ	ェ	ォ	a	b	c	d	e
	2	カ	キ	ク	ケ	コ	F	G	H	I	J
							f	g	h	i	j
	3	サ	シ	ス	セ	ソ	K	L	M	N	O
							k	l	m	n	o
	4	タ	チ	ツ	テ	ト	P	Q	R	S	T
							p	q	r	s	t
	5	ナ	ニ	ヌ	ネ	ノ	U	V	W	X	Y
							u	v	w	x	y
6	ハ	ヒ	フ	ヘ	ホ	Z	?	!	-	/	
						z					
7	マ	ミ	ム	メ	モ	¥	&				
8	ヤ	(ユ)	ヨ	*	#				
	ャ		ュ		ョ						
9	ラ	リ	ル	レ	ロ	1	2	3	4	5	
	@	/	-	_	:	.ne.jp	.co.jp	.ac.jp	@docomo.ne.jp		
0	ワ	ヲ	ン	ゝ	ゞ	6	7	8	9	0	
	わ								http://	https://	

・ A reading entered during an addition to FOMA card phonebook is in Katakana even in a full-pitch input mode.

- ※1 : Press   to switch between Uppercase input mode (top row) and Lowercase input mode (bottom row). You can also enter the character in uppercase first and then press  to change it to lowercase.
 - ※2 : Available only when it is possible to store "Pictograph" (p.311) such as "Text memo" (p.234), "Common phrases" (p.324). Note also that these characters are always entered as full-pitch characters. You cannot enter "Pictograph" while you are entering a body text in SMS. However, you can enter  and .
 - ※3 : "ゝ" and "ゞ" are displayed only when you are in a full-pitch input mode and the characters entered can take a "ゝ" and "ゞ". Any attempt to enter these characters at other times will result in a space being entered instead.
-  : A space is entered.

Symbols and Special Characters List

■ Full-pitch Symbols 1

、	。	、	、	、	:	:	?	!	”	°	’
、	”	^	—	—	、	、	、	//	全	々	
♂	○	—	—	/	\	~			…	…	
’	’	”	”	()	[]	{	}		
<	>	《	》	「	」	『	』	【	】	+	-
±	×	÷	=	≠	<	>	≤	≥	∞	∴	↑
♀	°	’	”	℃	¥	\$	¢	£	%	#	&
*	@	§	☆	★	○	●	◎	◇	◆	□	■
△	▲	▽	▼	※	〒	→	←	↑	↓	=	≡
≡	⊆	⊇	⊂	⊃	∩	∪	∧	∨	↔	⇒	⇔
∇	∃	∠	⊥	∩	∇	≡	≡	≡	≡	√	
∞	∞	∴	∫	∫	Å	%	#	♭	♮	†	‡
¶	○	わ	ゐ	ゑ	ワ	ヰ	ヱ	ヴ	カ	ケ	A

Β	Γ	Δ	Ε	Ζ	Η	Θ	Ι	Κ	Λ	Μ	Ν
Ξ	Ο	Π	Ρ	Σ	Τ	Υ	Φ	Χ	Ψ	Ω	α
β	γ	δ	ε	ζ	η	θ	ι	κ	λ	μ	ν
ξ	ο	π	ρ	σ	τ	υ	φ	χ	ψ	ω	Α
Б	В	Г	Д	Е	Ё	Ж	З	И	Й	К	Л
М	Н	О	П	Р	С	Т	У	Ф	Х	Ц	Ч
Ш	Щ	Ъ	Ы	Ь	Э	Ю	Я	а	б	в	г
д	е	ё	ж	з	и	й	к	л	м	н	о
п	р	с	т	у	ф	х	ц	ч	ш	щ	ъ
ы	ь	э	ю	я	—		┌	┐	└	┘	├
┤	┴	┬	┴	┬	┬	┬	┬	┬	┬	┬	┬
┬	┬	┬	┬	┬	┬	┬	┬	┬	┬	┬	┬

■ Full-pitch Symbols 2

①	②	③	④	⑤	⑥	⑦	⑧	⑨	⑩	⑪	⑫
⑬	⑭	⑮	⑯	⑰	⑱	⑲	⑳	I	II	III	IV
V	VI	VII	VIII	IX	X	ッ	ッ	ッ	ッ	ッ	ッ
㌢	㌣	㌤	㌦	㌧	㌨	㌩	㌪	㌫	㌬	㌭	㌮
mm	cm										
km	mg	kg	cc	m ³	平成	”	”	No.	KK.	TEL	⊕
⊕	⊖	⊗	⊘	(株)	(有)	(代)	明治	大正	昭和	≡	≡
∫	∫	Σ	√	⊥	∠	└	└	∴	∩	∪	

■ Half-pitch Symbols

!	”	#	\$	%	&	’	()	*	+	,
-	.	/	:	:	<	=	>	?	@	[¥
]	^	_	:	:	{		}	~	.	「	」
.	-

NOTE

● If you send special symbols to a mobile phone that is not subscribed to the i-mode mail service or to a PC, they may not be displayed properly.

■ Symbols in Japanese Conversion

You can enter symbols in mail messages, etc, by entering “きごう” while you are in Kanji/hiragana input mode, and then converting the text to display the symbol candidates. You can also enter the name of a symbol in hiragana as follows, and then convert the text into the desired symbol.

Symbol name (entering characters)	Symbol
あっと、あっとまーく	@
いこーる	=
えん	¥
おす	↑
おなじ	々
おなじく	//
おんぷ	♪
かける	×
かっこ	() [] {} $\langle \rangle$ $\llbracket \rrbracket$ $\llbracket \llbracket \llbracket \llbracket$ $\llbracket \llbracket \llbracket \llbracket \llbracket \llbracket \llbracket \llbracket$
から	~
こめ	*
ころん	:
こんま	,
さんかく	△▲▽▼

Symbol name (entering characters)	Symbol
しゃせん	∧
しかく	◻◼◾◿
たす	+
どう	ヽヾ>ヱ〃々
ばーせんと	%
ひく	-
ひしがた	◇◆
ほし	☆★
まる	○●◎
むげん	∞
めす	♀
やじるし	↔↕↖↗
ゆうびん	〒
るーと	√
わる	÷

Lists of Pictographs and Smiley Face Symbols

■ List of Pictographs 1

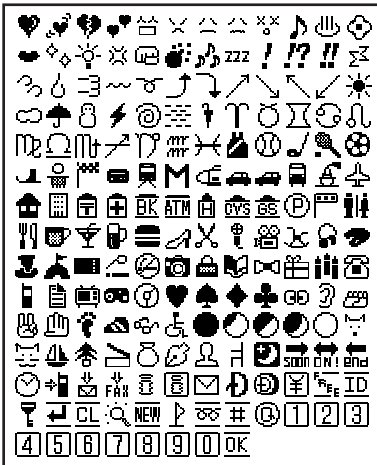

■ List of Pictographs 2

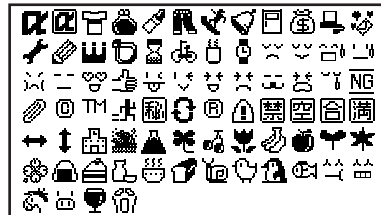

NOTE

- “Pictograph 2” is not displayed properly when sending to a mobile phone or PC that is not compatible with it.

■ Smiley Face Symbols

You can enter smiley face symbols in mail messages, etc, by entering “かお” or “かおもじ” while you are in Kanji/hiragana input mode, and then converting the text to display the different smiley face symbol candidates. You can also enter the meaning of a smiley face symbol in hiragana as follows, and then convert the text into the desired smiley face symbol.

Entering characters(Meanings)	Face symbol	Entering characters(Meanings)	Face symbol
ありがとう/ありがとう(Thanks!)	㊄㊄	しくしく(Sob, sob)	㊄㊄
ばんざい(Hurrah!)	㊄㊄	さよなら(Good-bye!)	㊄㊄
わーい(Wow!)	㊄㊄	いたた(Ouch!)	㊄㊄
おーい(Hey!)	㊄㊄	えーん(Crying)	㊄㊄
ぶい(Vvvv!)	㊄㊄	なぜ(Why?)	㊄㊄
ぎゃはは(Ha-ha!)	㊄㊄	がーん(Shocked!)	㊄㊄
あは(Ah hal)	㊄㊄	えへん(Ahem!)	㊄㊄
にこ(Smile!)	㊄㊄	むい(Sullen)	㊄㊄
にこ(Smile! smile)	㊄㊄	いかり(Angry)	㊄㊄
ちゅ(Kiss!)	㊄㊄	むか(Offended)	㊄㊄
ちゅ(Kiss! Kiss!)	㊄㊄	こそこそ(Whisper)	㊄㊄
わくわく(I'm excited!)	㊄㊄	じーつ(Gaze)	㊄㊄
ういんく(Wink)	㊄㊄	きこえない(Not heard)	㊄㊄
さよなら(Good-bye!)	㊄㊄	こまつたもんだ(My goodness!)	㊄㊄
がんば(Cheer up!)	㊄㊄	ぶたー(Pig)	㊄㊄
ね(Isn't it?)	㊄㊄	こあら(Koala)	㊄㊄
ぼりぼり(Scratch, scratch!)	㊄㊄	いっぶく(Take a break)	㊄㊄
ひやあせ(Sweat!)	㊄㊄	いっぶく(Take a break)	㊄㊄
あせあせ(Sweat! Sweat!)	㊄㊄	ほし(Star)	㊄㊄
びくっ(Twitch!)	㊄㊄	ねてる(Zzzz...)	㊄㊄
どき(Shocked!)	㊄㊄	ねむい(I'm sleepy)	㊄㊄
え(What?)	㊄㊄	めも(Memo)	㊄㊄
めがてん(W*H*A*T?)	㊄㊄	うん(Yeah)	㊄㊄
はてな(Wait a minute!)	㊄㊄	かんぱい(Cheers!)	㊄㊄
きらーん(Twinkle, twinkle)	㊄㊄	ども(Well, well)	㊄㊄

Stand-by display list



Aqua



Dragon Quest V-1



Dragon Quest V-2



Healin'



Drivin'



Tropical Fish



Flower



Twilight



Dancin'



Floatin'

Lists of Common Phrases

■ Folder 1 (preset common phrases)

No	Messages
1	Sorry
2	Thank you
3	Congratulations!
4	It's time
5	Wait a minute
6	Just arrived
7	Schedule change
8	Where are you?
9	Do your best
0	What are you doing?

■ Folder 2 (preset common phrases)

No	Messages
1	All right
2	I hope you are well
3	Well done
4	Emergency
5	How do you think?
6	Please call
7	I will be late
8	Leave a message on voice mail
9	E-mail me via i-mode
0	Thank you for your help

Kuten Code List

Triple-digit numbers on the left side of each column indicate the first to third digit of Kuten codes. The numbers on top of each column indicate the fourth digit of Kuten codes.

<Example : To enter “全”>

Enter “012” in the first to third digit of Kuten codes and then enter “4” in the fourth digit of Kuten codes.

● The display on the screen may differ from the characters and symbols on the Kuten code list.

First to third digit of Kuten codes	Fourth digit of Kuten codes										First to third digit of Kuten codes	Fourth digit of Kuten codes										First to third digit of Kuten codes	Fourth digit of Kuten codes									
0 1 2 3 4 5 6 7 8 9	0	1	2	3	4	5	6	7	8	9	0 1 2 3 4 5 6 7 8 9	0	1	2	3	4	5	6	7	8	9	0 1 2 3 4 5 6 7 8 9	0	1	2	3	4	5	6	7	8	9
010	!	~	()	&	:	..	:	:	..	?																						
011	~	>	／	／	全	々	々	々	々	々																						
012	<	>	／	／	全	々	々	々	々	々																						
013	<	>	／	／	全	々	々	々	々	々																						
014	<	>	／	／	全	々	々	々	々	々																						
015	<	>	／	／	全	々	々	々	々	々																						
016	<	>	／	／	全	々	々	々	々	々																						
017	<	>	／	／	全	々	々	々	々	々																						
018	<	>	／	／	全	々	々	々	々	々																						
019	★	◆	◆	◆	◆	◆	◆	◆	◆	◆																						
020	→	←	↑	↓	→	←	↑	↓	→	←																						
021	→	←	↑	↓	→	←	↑	↓	→	←																						
022	→	←	↑	↓	→	←	↑	↓	→	←																						
023	→	←	↑	↓	→	←	↑	↓	→	←																						
024	→	←	↑	↓	→	←	↑	↓	→	←																						
026	∠	∠	∠	∠	∠	∠	∠	∠	∠	∠																						
027	∠	∠	∠	∠	∠	∠	∠	∠	∠	∠																						
028	∠	∠	∠	∠	∠	∠	∠	∠	∠	∠																						
029	∠	∠	∠	∠	∠	∠	∠	∠	∠	∠																						
031																																
032	4	5	6	7	8	9	0	1	2	3																						
033																																
034	H	R	J	T	A	K	U	B	L	W																						
035	I	S	R	T	A	K	U	B	L	W																						
036																																
037	f	g	h	i	j	k																										
038	p	q	r	s	t																											
039																																
040																																
041	あ	か	さ	た	な	に	ひ	ふ	よ	ゑ																						
042	あ	か	さ	た	な	に	ひ	ふ	よ	ゑ																						
043	あ	か	さ	た	な	に	ひ	ふ	よ	ゑ																						
044	あ	か	さ	た	な	に	ひ	ふ	よ	ゑ																						
045	あ	か	さ	た	な	に	ひ	ふ	よ	ゑ																						
046	あ	か	さ	た	な	に	ひ	ふ	よ	ゑ																						
047	あ	か	さ	た	な	に	ひ	ふ	よ	ゑ																						
048	あ	か	さ	た	な	に	ひ	ふ	よ	ゑ																						
050																																
051																																
052																																
053																																
054																																
055																																
056																																
057																																
058																																
060		A	B	M	Γ	Δ	E	O	H	P																						
061		K	Λ	X	Γ	Δ	E	O	H	P																						
062		θ	ι	κ	λ	μ	ν	ξ	ο	π																						
063		θ	ι	κ	λ	μ	ν	ξ	ο	π																						
064		θ	ι	κ	λ	μ	ν	ξ	ο	π																						
065		θ	ι	κ	λ	μ	ν	ξ	ο	π																						
070			B	K	Γ	Δ	E	O	H	P																						
071			Λ	Χ	Π	Σ	Τ	Υ	Φ	Ψ																						
072			Ω	Α	Β	Γ	Δ	Ε	Ζ	Η																						
073			Θ	Ι	Κ	Λ	Μ	Ν	Ξ	Ο																						
074			Π	Σ	Τ	Υ	Φ	Ψ	Ω	Α																						

First to third digit of Kuten codes	Fourth digit of Kuten codes									First to third digit of Kuten codes	Fourth digit of Kuten codes									First to third digit of Kuten codes	Fourth digit of Kuten codes																																																		
	0	1	2	3	4	5	6	7	8		9	0	1	2	3	4	5	6	7		8	9	0	1	2	3	4	5	6	7	8	9																																							
245	糊	楞	246	247	248	249	250	251	252	253	254	255	256	257	258	259	260	261	262	263	264	265	266	267	268	269	270	271	272	273	274	275	276	277	278	279	280	281	282	283	284	286	287	288	289	290	291	292	293	294	295	296	297	298	299	300	301	302	303	304	305	306	307	308	309	310	311	312	313	314	315
245	糊	楞	246	247	248	249	250	251	252	253	254	255	256	257	258	259	260	261	262	263	264	265	266	267	268	269	270	271	272	273	274	275	276	277	278	279	280	281	282	283	284	286	287	288	289	290	291	292	293	294	295	296	297	298	299	300	301	302	303	304	305	306	307	308	309	310	311	312	313	314	315
315	須	吹	316	317	318	319	320	321	322	323	324	325	326	327	328	329	330	331	332	333	334	335	336	337	338	339	340	341	342	343	344	345	346	347	348	349	350	351	352	353	354	355	356	357	358	359	360	361	362	363	364	365	366	367	368	369	370	371	372	373	374	375	376								
315	須	吹	316	317	318	319	320	321	322	323	324	325	326	327	328	329	330	331	332	333	334	335	336	337	338	339	340	341	342	343	344	345	346	347	348	349	350	351	352	353	354	355	356	357	358	359	360	361	362	363	364	365	366	367	368	369	370	371	372	373	374	375	376								
377	誦	水	378	379	380	381	382	383	384	385	386	387	388	389	390	391	392	393	394	395	396	397	398	399	400	401	402	403	404	405	406	407	408	409	410	411	412	413	414	415	416	417	418	419	420	421	422	423	424	425	426	427	428	429	430	431	432	433	434	435	436										
377	誦	水	378	379	380	381	382	383	384	385	386	387	388	389	390	391	392	393	394	395	396	397	398	399	400	401	402	403	404	405	406	407	408	409	410	411	412	413	414	415	416	417	418	419	420	421	422	423	424	425	426	427	428	429	430	431	432	433	434	435	436										
437	438	439	440	441	442	443	444	445	446	447	448	449	450	451	452	453	454	455	456	457	458	459	460	461	462	463	464	465	466	467	468	469	470	471	472	473	474	475	476	477	478	479	480	481	482	483	484	485	486	487	488	489	490	491	492	493	494	495	496	497	498	499	500								
437	438	439	440	441	442	443	444	445	446	447	448	449	450	451	452	453	454	455	456	457	458	459	460	461	462	463	464	465	466	467	468	469	470	471	472	473	474	475	476	477	478	479	480	481	482	483	484	485	486	487	488	489	490	491	492	493	494	495	496	497	498	499	500								

Table with 12 columns: First to third digit of Kuten codes (0-9), Fourth digit of Kuten codes (0-9), and corresponding Chinese characters for each code combination.

Multi Access Combination Patterns

Major multi access combination patterns are shown below.

Current communication status \ Communication newly started	Make/Receive a voice call	Make/Receive a videophone call	Use i-mode	Use i-αappli	Send/Receive i-mode mail	Packet communication via PC	64K data communication	Send/Receive SMS
During a voice call	×※1	×	×	○	○	○	×※5	○
During a videophone call	×	×	×	×	×※4	×	×	△※2
During i-mode	○	△※3	—	—	○	×	×	○
During packet data communication	○	×	×	△※7	×	—	×	○
During 64K data communication	×※6	×	×	×	×	×	—	○

- : Can be activated.
- × : Cannot be activated.
- △ : Can be activated depending on situation.
- : Functionally incompatible.

- ※1 : If you have subscribed to a network service such as the “Call waiting” service, multi access is available depending on combination.
- ※2 : SMS cannot be sent.
- ※3 : Videophone calls cannot be received.
- ※4 : During videophone calls, i-mode mail and Msg. Request/Free are not received, and are stored in the i-mode center instead. You can receive those stored i-mode mail and Msg. Request/Free by “Check new message” (p.106 and p.184 in 『Application』) after the videophone call ends.
- ※5 : You can receive 64K data communication that comes after ending a voice call.
- ※6 : You can receive a voice call that comes after ending 64K data communication.
- ※7 : The i-αappli which needs communication cannot be activated.

Multi Task Combination Patterns

Major multi task combination patterns are shown below.

Function to use / Current status	Mail	i-mode menu sites	i-αppli	Settings	Multimedia	Accessory	Network service	Phonebook	Own data	Original menu
During starting mail group	○※1	○	○	○※2	○	○※4	○	○※9	○	○
During starting i-mode group	○	×	×	○※2	○	○※4	○	○※9	○	○
During starting setting group	○	○	○	×	○	○※4	×	○※9	○	○
During starting tool group	○	○	○	○※2	×	×	○	×	×	○
During a videophone call	×	×	×	×	×	×※5	×	×	×	×
During a voice call	○	○	×	×※3	×	×※6	○※8	○※9	○※10	○
During i-mode communication	○	△	△	○※2	○	○※4	○	○※9	○	○
During packet communication via PC	○	○	○	○※2	○	○※4	○	○※9	○	○
During 64K data communication	○	○	×	×※3	×	×※7	○※8	○※9	○※10	○

○ : Can be activated.

× : Cannot be activated.

△ : Cannot be activated simultaneously.

※1 : “Compose message” and “Compose SMS” are unavailable simultaneously.

※2 : Unavailable depending on a function.

※3 : Only “Set time”, “Keypad sound” and “Pause dial” are available.

※4 : “Voice announce”, “Ir exchange”, “UIM operation” and “SD-PIM” are unavailable.

※5 : Only “Voice memo” is available. (Hold down  [Memo/Check] for 1 second or more.)

※6 : Only “Camera”, “Schedule”, “ToDo”, “Text memo”, “Calculator”, “Voice memo”, “Access reader”, “Bar code reader” and “Dictionary” are available. However, “Access reader” and “Bar code reader” can display the list of character recognition data and their details, but cannot scan new characters.

※7 : Only “Camera”, “Schedule”, “ToDo”, “Text memo”, “Calculator”, “Access reader”, “Bar code reader” and “Dictionary” are available. However, “Access reader” and “Bar code reader” can display the list of character information data and their details, but cannot scan new characters. Only “Photo mode” and “Continuous mode” are available in “Camera”.

※8 : “Voice mail” cannot be played. “Voice mail” and “Additional service” cannot be set for special numbers (p.295).

※9 : “Restrictions” is unavailable.

※10 : “Common phrases”, “Own dictionary” and “DL dictionary” are unavailable.

● When using the following functions, you cannot use other functions:

- Videophone
- Downloading an i-αppli software
- Ir exchange
- Exporting / importing data using a miniSD memory card
- UIM operation
- Camera (Mega pixel mode/Long duration mode)
- Editing movies/i-motion
- Data transmission (OBEX) function
- Updating software

● Some functions cannot be operated while other functions are started.

Services Available for the FOMA Terminal

Service		Phone number
Collect call (calls charged to the receiver)		(No area code) 106
Directory information for general phones and DoCoMo mobile phones (charged) (Unlisted phone numbers cannot be given.)		(No area code) 104
Telegram (charged)	8:00 am to 10:00 pm	(No area code) 115
Time (charged)		(No area code) 117
Weather forecast (charged)		Area code of an area you want to know + 177
Emergency call to the police		(No area code) 110
Emergency call for a fire engine or an ambulance		(No area code) 119
Emergency call for help with maritime accidents		(No area code) 118

NOTE

- When you use the Collect Call Service (106), the receiver will be billed for the call charge plus an additional service charge for each call (90 yen (94.5 yen tax included)). As of May, 2004
- When you use the Directory Information Service (104), you will be billed for the call charge plus an additional service charge of 100 yen (105 yen tax included). A free service is available for persons with sight or upper-limb handicaps. For details, call 116 from a general phone.(As of May, 2004)
- When you call 110 (police), 119 (fire or ambulance) or 118 (emergency number for maritime accidents) from the FOMA terminal, the police or the fire department cannot detect your location and may need to call you back for confirmation purposes. You should tell them that you are making a call from a mobile phone and provide your phone number and exact current location. You should also take care to stay in the same place during the call so that the call is not disconnected. Do not turn the FOMA terminal off for at least 10 minutes after the call so that you can receive calls.
- Depending on your location, there is a possibility that you may not be connected to the police or the fire department for the area you are in. If this happens, call from the nearest pay phone or general phone.
- If you use the “Call Forwarding Service” or “Voice Warp Service” for your general phone and specify your mobile phone number as the forwarding destination, callers may hear a ring tone even when your mobile phone is busy, outside the service area, or turned off, depending on your settings.
- Note that 116 (NTT Sales counter), Dial Q2, Message Dial and credit card calls are not available. (Credit card calls can be made from general phones or pay phones to the FOMA terminal.)

Options and Accessories

By combining various options and accessories, your FOMA terminal can support a wide range of applications to meet both your personal and professional needs. Note that some products may not be available depending on the area you are in. For more information, contact a DoCoMo service counter or a retail outlet. For details of an option or accessory, refer to User's Manual.

■ Going out

- Carrying case N05
 - Earphone/microphone with switch P001/P002※
 - Stereo earphone set P001※
 - Flat-type earphone/microphone with switch P01/P02
 - Flat-type stereo earphone set P01
- ※: To connect to FOMA N900iS, the earphone jack conversion adapter P001 is necessary.

■ Inside a car

- DC adapter N03
- Cell phone holder N04

■ Recharging

- AC adapter N03
- Desktop holder N04



■ Backup













































- Battery Pack N06
- Rear cover N02







































■ PC connection









- Data communication adapter N01







Menu Function List

















- Functions with ☆ cannot be used when another function is being activated.
- Functions with ∇ are displayed only during calls.
-  indicates that you are required to hold down the key shown to the left of  until the screen display changes.







High level item	Middle item	Detail item	Menu No. (Key operation)	Description	See page
 Mail			–	Displays the Mail menu.	p.136 in [Application]
 i-mode			–	Displays the i-mode menu.	p.24 in [Application]
 i-appli			–	Displays the i-appli menu.	p.66 in [Application]
 Settings	Incoming call	Ring volume	   	Adjusts the ring tone volume.	p.79
		Select ring tone	  	Selects a ring tone.	p.163
		Vibrator	  	Sets the vibrator (vibration) pattern. The vibrator can also be set to be "OFF".	p.167
		Illumination	  	Sets the flashing pattern of the incoming call lamp for incoming calls.	p.185
		Manner mode set	  	Selects the manner mode operation from "Manner mode", "Super silent" or "Original".	p.136
		Disp. phonebook image	–	Sets the phonebook image display "ON/OFF" for incoming calls.	p.181
		Answer setting	  	Selects the key function when receiving calls from "Any key answer", "Quick silent" or "OFF".	p.159
		Fold setting	  	Sets operations when the FOMA terminal is folded during a call.	p.160
		☆Mail/Msg. ring time	  	Sets the ring tone "ON/OFF" and the ringing time for incoming mail/messages.	p.240 in [Application]
		☆Ringing time	  	Sets the time until the ringing operation starts for incoming calls.	p.140
	Info notice setting	  	Selects how to check missed calls/new mail with the FOMA terminal folded from "ON/OFF".	p.77	
	Talk	Noise reduction	  	Sets the function for making your phone conversation clearer by reducing surrounding noise to "ON/OFF".	p.156
		Quality alarm	  	Sets whether to emit an alarm tone when the line may be cut off during a call due to poor radio wave condition.	p.158
		Reconnect control	  	Sets an alarm tone when a call is reconnected due to poor radio wave condition.	p.157
		Illumination in talk	–	Sets the flashing color of the incoming call lamp during a call.	p.186
		Select hold tone	–	Selects the guidance to be played while the call is on hold.	p.158















High level item	Middle item	Detail item	Menu No. (Key operation)	Description	See page
Settings	Video-phone	Image quality	—	Sets the image quality for videophone calls.	p.97
		My image sending	—	Sets whether to submit a camera image or a substitute image when making a videophone call.	p.98
		Select image	—	Sets an image to be sent to the other party during a videophone call.	p.98
		Voice call auto switch	—	Sets whether to redial in voice call when you were unable to connect the videophone call.	p.95
		Remote monitor	—	Sets remote monitoring.	p.102
		Select image V-phone	—	Sets the image and its size to be displayed on the main screen during a videophone call.	p.100
	Display	Display setting	  	Sets an image to be displayed on the FOMA terminal display (the standby display and wake-up screen, etc.)	p.177
		Display light	  	Sets how the display light for the display, indicator display and keypad is turned on/off. You can set OFF.	p.183
		☆Color pattern	  	Selects the display color pattern such as characters and background.	p.182
		☆Indicator display	  	Sets how to display the indicator display.	p.187
		☆Font	  	Switches the character fonts displayed on the display and indicator display.	p.190
		Desktop icon	  	Changes the title of the desktop icons pasted on the desktop (standby display) or deletes the icons.	p.170
		☆Select language	  	Switches the screen display or indicator display between Japanese and English.	p.65
		☆Original menu	  	Stores your frequently used functions in the original menu.	p.244
		Menu display set	  	Sets how to display the menu icon guide and the detail items.	p.243
		☆Viewer settings	—	Sets whether to display the image viewer list screen as a title name or an image.	p.181
		Automatic display	  	Sets the FOMA terminal to open to display a specified phone number.	p.125
Icons	  	Displays the explanation of icons displayed at the top of the screen.	p.39		
Call data	Call duration	  	Checks the call duration of last call or the total call duration.	p.161	
	Reset call duration	  	Resets the total call duration.	p.162	

High level item	Middle item	Detail item	Menu No. (Key operation)	Description	See page
Settings	Call data	Call time display	 4.25 8.25	Sets whether to display the call duration during a call.	p.161
		Clock	Set time	 3.25 T	Sets (changes) the date and time.
	Clock display		 3.25 9.25	Sets the clock display and display size.	p.191
	Alarm setting		-	Selects alarm notification for "Alarm clock", "Schedule" or "ToDo" from "Operation preferred" or "Alarm preferred".	p.209
	Lock/ Security	☆All lock	-	Disables operations other than power ON/OFF.	p.200
		☆PIM lock	-	Disables private information operations such as Phonebook, Schedule and Mail.	p.204
		☆Self mode	-	Sets so you cannot use phones or mails, etc.	p.207
		☆Keypad dial lock	-	Disables outgoing calls and mail with the keypad.	p.205
		☆Reject unknown	-	Sets to reject incoming calls from a phone number not stored in the phonebook.	p.144
		Call setting w/o ID	 T 0.25	Sets whether to reject incoming calls according to the reason for no caller ID informed.	p.145
		Change Security code	 2.25 9.25	Changes your security code.	p.193
		PIN setting	-	Sets the PIN1 code entry setting and changes the PIN1 code / PIN2 code.	p.194
		☆Secret mode	 4.25 0.25	Calls up, stores, corrects or deletes secret data.	p.201
		☆Secret only mode	 4.25 T	Calls up, stores, corrects or deletes secret data only.	p.201
	Connection setting	☆Connection timeout	-	Sets the waiting time when connecting to a site, etc.	p.128 in [Application]
		☆i-mode checking	-	Selects the type to be checked during i-mode checking from mail, Msg. Request or Msg. Free.	p.129 in [Application]
		☆Host selection	 8.25 T	Sets the connection destination for services other than i-mode.	p.130 in [Application]
		☆SMS center selection	-	Sets the SMS center address and "Type of number".	p.241 in [Application]
		☆Certificate	-	Sets the SSL certificate reference and "Valid/Invalid" for certificates.	p.132 in [Application]
		☆Certificate host	-	Sets the certificate operation (issue application, downloading, invalidation) for the host center.	p.133 in [Application]

High level item	Middle item	Detail item	Menu No. (Key operation)	Description	See page	
Settings	i-αppli settings	☆Display software info	—	Sets whether to display software information before downloading software.	p.71 in 『Application』	
		☆αDisplay light	—	Sets whether enable the control of back light settings from software.	p.85 in 『Application』	
		☆αVibrator	—	Sets whether enable the control of the vibrator from software.	p.85 in 『Application』	
		☆αIndicator display	—	Sets whether enable the control of the indicator display from software.	p.85 in 『Application』	
		☆End stand-by display	—	Ends the i-αppli standby display.	p.89 in 『Application』	
	External option	Earphone		—	Selects the parts emitting the ring tone from “Earphone+Speaker” and “Earphone”.	p.261
		Automatic answer		—	Sets whether to automatically answer an incoming call when the earphone/ microphone with switch (optional) is connected.	p.262
	Other settings	Keypad sound		—	Sets whether to emit the confirmation sound when pressing keypad.	p.168
		Charge sound	—	—	Sets the confirmation sound to ON/OFF when charging starts/ends.	p.169
		☆SRS_WOW setting	—	—	Sets whether to enable sound effects set to the i-motion play sound.	p.318 in 『Application』
		Battery level		—	Indicates the remaining charge of the battery pack.	p.63
		Side keys guard		—	Sets the side key functions “ON/OFF” when the FOMA terminal is folded to.	p.208
		☆Input method		—	Selects the character entry mode, and sets the prediction function and the guidance display to “ON/OFF”.	p.326
		☆Record display set	—	—	Sets whether to display the received call record and redial/dialed call record.	p.206
		Pause dial		—	Sends push signals from the FOMA terminal.	p.146
		☆Subaddress setting	—	—	Uses “X” in a phone number to set numbers as a subaddress.	p.150
		☆Prefix setting	—	—	Sets a prefix to be added before a phone number from the function menu.	p.149
		☆PLMN setting	—	—	Sets PLMN (telecommunication carrier name).	p.259
		Neuropointer	—	—	Sets the Neuropointer.	p.251
		USB mode setting	—	—	Uses the miniSD memory card as storage memory of a PC.	p.470 in 『Application』

High level item	Middle item	Detail item	Menu No. (Key operation)	Description	See page
 Settings	Other settings	☆Reset settings	 2.25 3.25	Resets various settings.	p.254
		☆Software update	—	Checks whether the FOMA terminal needs software update. If so, updates it with the packet communication.	p.375
 Multimedia	Melody player		 1 6.25	Plays a melody, etc.	p.341 in 『Application』
	Image viewer		 4.25 6.25	Displays and sets downloaded images and animations.	p.302 in 『Application』
	Movie player		—	Plays and sets i-motion downloaded from sites or Web pages and movies shot with the camera.	p.316 in 『Application』
	Chara-den player		—	Displays, operates and shoots Chara-den.	p.332 in 『Application』
 Accessory	Camera		—	Uses the camera function.	p.254 in 『Application』
	Schedule		 4.25 5.25	Stores scheduled events, holidays and anniversaries. If stored, sets the FOMA terminal to emit an alarm tone at set date and time to alert you.	p.216
	Alarm clock		 4.25 4.25	Uses your FOMA terminal as an alarm clock.	p.213
	ToDo		 9.25 5.25	Manages the progress of your plan.	p.228
	Text memo		 4.25 2.25	Stores text messages.	p.234
	Calculator		 8.25 5.25	Uses your FOMA terminal as a calculator.	p.234
	Play/Erase msg.			Plays and deletes recorded messages and voice memos.	p.247
	Record message		 5.25 5.25	Sets the record message.	p.84
	Voice memo		 4.25 3.25	Records your voice while the standby display is shown.	p.246
	Recording		 LONG	Records the other party's voice while talking on the phone.	p.246
	☆Voice announce		 9.25 1 7	Records voice data for the alarm tone, answer message, ring tone and hold tone.	p.249
	☆Ir exchange		 7.25 9.25	Exchanges data such as phonebook entries and received mails with other FOMA terminals.	p.348 in 『Application』
	☆UIM operation		—	Exchanges data between the FOMA terminal (main unit) and FOMA card.	p.130
	Forwarding image		—	Sets whether to transfer pictures/movies when sending phonebook data with the Ir exchange or data transmission (OBEX) function.	p.359 in 『Application』
	Access reader		—	Scans a printed phone number as characters with the built-in camera.	p.283 in 『Application』

High level item	Middle item	Menu No. (Key operation)	Description	See page
 Accessory	Bar code reader	–	Recognizes the bar code and QR code information with the built-in camera.	p.289 in 『Application』
	☆SD-PIM	–	Calls up data stored in the miniSD memory card.	p.378 in 『Application』
	Dictionary	–	There are three types of dictionaries; English-Japanese, Japanese-English and Japanese available for looking up words.	p.237
 Service	Check messages	 2.28 5.28	Inquires the voice mail service center (if you subscribe to the voice mail service settings).	p.276
	Notify caller ID	 1.28 2.28	Sets your caller ID to “Notify/Not notify”.	p.285
	Voice mail	–	Activates, deactivates and sets various voice mail service settings.	p.273
	Call waiting	–	Activates, deactivates and sets various call waiting service settings.	p.281
	Call forwarding	–	Activates, deactivates and sets various call forwarding service settings.	p.278
	Bar nuisance call	–	Stores a Caller ID to reject a call.	p.284
	Caller ID request	–	Plays a guidance requesting a caller with no caller ID to call again with the caller ID informed.	p.286
	Arrival call act	–	Selects how to handle another incoming call during a call.	p.291
	Set arrival act	–	Activates, deactivates and checks the Set arrival act.	p.292
	Remote control	–	Activates, deactivates and checks remote operations (voice mail and call forwarding, etc.) from phones other than the FOMA terminal.	p.294
	Dual network	–	Switches and checks the network .	p.287
	English guidance	–	Sets the guidance for outgoing or incoming calls to English.	p.289
	Additional service	–	Stores and sets new network services.	p.295
	Service dial	–	Makes a call to DoCoMo general information desk or service desk with quick operation.	p.290
 Phonebook	Add to phonebook	–	Stores phonebook entries in the FOMA terminal (main unit) or FOMA card.	p.108
	Search phonebook	–	Calls up stored phonebook entries by using one of 7 search methods such as reading, name, phone number or address.	p.116
	No. of phonebook	 2.28 2.28	Checks the stored phonebook entries.	p.134
	Utilities	 6.28 2.28	Checks and cancels the utility settings for phone numbers and mail addresses.	p.120

High level item	Middle item	Menu No. (Key operation)	Description	See page
 Phonebook	☆Restrictions	 1  2	Checks and cancels the restriction settings for phone numbers stored in the Phonebook.	p.141
	Group setting	 2  6	Changes group names and sets incoming/outgoing calls/mail for each group.	p.128
 Own data	Own number	 0	Displays your phone number. Your name, home phone number, address, mail address, memo and image, etc. can be stored.	p.239
	Received calls	 2  4	Displays the received date, time and phone number for received calls/mail, etc.	p.151
	Dialled calls	—	Displays the dialed/sent date, time and phone number for dialed calls and sent mail, etc.	p.151
	Mail member	 9  2	Stores multiple addresses to specify multiple destinations at one time.	p.161 in 『Application』
	Common phrases	 3  8	Stores created common phrases, or changes the preset common phrases.	p.324
	Own dictionary	 8  2	Stores up to 100 words with your preferred readings conversion candidates.	p.321
	DL dictionary	—	Enables downloaded dictionaries.	p.323

Major Specifications

Model		FOMA N900iS		
Dimensions (H×W×D)		Approx. 102×48×26 mm (when folded) (thickest part)		
Weight		Approx. 115 g (with battery pack attached)		
LCD	Color	Main display: TFT 65,536 colors		
		Sub display: STN 4,096 colors		
	Size	Main display: 2.2 inches		
		Sub display: 0.9 inches		
Number of pixels	Main display: 76,800 pixels (240×320)			
	Sub display: 3,600 pixels (120×30)			
Continuous standby time ^{※1※3}		Stationary: Approx. 430 hours ^{※4} Moving: Approx. 350 hours ^{※5}		
Continuous call time ^{※2,3}		Voice call: Approx. 140 minutes Videophone call: Approx. 90 minutes		
Maximum output power		0.25 W		
Battery pack type		Dedicated lithium-ion battery		
Power supply voltage		3.8 V		
Battery capacity		850 mAh		
Charge time with the AC adapter		Approx. 120 minutes		
Charge time with the desktop folder		Approx. 120 minutes		
Charge time with the DC adapter		Approx. 120 minutes		
Image pickup device	Type	Out-camera: Super CCD honeycomb In-camera: CCD ^{※6}		
	Size	Out-camera: 1/3.8 inches In-camera: 1/9 inches		
Camera	Number of effective pixels ^{※7}	Out-camera: 1 million pixels (816×612×2) In-camera: 110 thousand pixels (368×296)		
	pixels ^{※7}	Out-camera: 2 million pixels (1,616×1,212) ^{※8} In-camera: 100 thousand pixels (352×288)		
	Zoom (digital)	Out-camera: Approx. 6.2 times max. In-camera: Approx. 2 times max.		
Recording	Still image	Photo size	1,616×1,212 1,280×960 640×480 (VGA) 352×288 (CIF)	240×269 (Standby display) 176×144 (Large Mail) 128×96 (Small Mail)
		File format	JPEG	
		Movie	Recording size	176×144 (Large) 128×96 (Small)
	File format		MP4 (Mobile MP4)	
	Frame rate		Maximum 15 fps	

※1 : The continuous standby time is an estimated time when radio waves are strong enough to receive properly with the FOMA terminal folded. Note that the actual continuous talk/standby time may decrease by as much as half depending on the following conditions: the battery level, the function settings, ambient environment such as temperature, the status of radio wave conditions (out of reach or weak). Using i-mode will decrease the talk (communication) and standby times. Even when you do not talk on the phone or use i-mode, creating i-mode mail or starting up downloaded i-cppii and the i-cppii standby display will also decrease the talk (communication) and standby times.

※2 : The continuous talk time is an estimated time you can talk while radio waves are strong enough to send and receive.

※3 : Performing data communication or multi access or activating the camera will also shorten the above talk and standby times.

※4 : The average usage time when the FOMA terminal is folded and standing still, while radio waves can be normally received.

※5 : The average usage time when the FOMA terminal is folded under condition of "stationary", "moving" and "out of service area" within the area where radio waves can be normally received.

※6 : CCD (charge coupled device) is an image pickup device that composes the portion corresponding to a silver film for a camera.



※7 : The description is based on the Digital Camera Committee's guideline (JCIA GLA03).

※8 : Maximum 1,616×1,212 is provided with the honeycomb signal processing.









● Troubleshooting









Malfuction Checklist

Problem	Points to check	See page
The FOMA terminal does not turn on (The FOMA terminal cannot be used).	<ul style="list-style-type: none"> ● Is the battery pack properly attached? ● Has the battery pack run out? 	<p>p.56</p> <p>p.63</p>
Nothing responds by pressing any key.	<ul style="list-style-type: none"> ● Turn off the power, then back on. 	p.62
The animation similar to the one shown on the right appears and an alarm tone sounds.	<ul style="list-style-type: none"> ● The battery pack has run out. Charge the battery pack. 	p.55
The "📶" icon appears and I hear a busy tone.	<ul style="list-style-type: none"> ● Are you outside the service area or in a location with poor radio wave reception? 	p.62
I cannot make a call by pressing the dial keys.	<ul style="list-style-type: none"> ● Is Keypad dial lock set? ● Is the FOMA terminal in Self mode? ● Is Restrict dialing set? 	<p>p.205</p> <p>p.207</p> <p>p.141</p>
I dialed a number and initiated the call, but all I hear is a busy tone.	<ul style="list-style-type: none"> ● Did you start dialing without waiting for the dial tone first? ● Did you dial the area code? ● Is the "📶" icon displayed? ● Is "Please wait" displayed? 	<p>p.70</p> <p>p.70</p> <p>p.62</p> <p>p.70</p>
I cannot receive calls. The FOMA terminal does not ring, but I see new records in Received calls.	<ul style="list-style-type: none"> ● Are any of the following functions set? <ul style="list-style-type: none"> In Restrictions <ul style="list-style-type: none"> · Call rejection · Call forwarding · Call acceptance · Voice mail In Ringing time <ul style="list-style-type: none"> · Set mute seconds · Missed calls display Reject unknown <ul style="list-style-type: none"> · Not supported: Reject · User unset: Reject In Call setting w/o ID <ul style="list-style-type: none"> · Payphone: Reject ● Is the FOMA terminal set to Manner mode? ● Is the FOMA terminal set to Driving mode? ● Is All lock set? ● Is Self mode set? ● Is the start time of voice mail or call forwarding service set to "0"? ● Is caller ID request set to Activate? ● Is mova valid with the dual network service? ● You may have set the Ring volume to "Silent".	<p>p.141</p> <p>p.140</p> <p>p.144</p> <p>p.145</p> <p>p.135</p> <p>p.82</p> <p>p.200</p> <p>p.207</p> <p>p.274</p> <p>p.279</p> <p>p.287</p> <p>p.287</p> <p>p.79</p>
Mail ring tones and alarm tones sound but no ring tone sound when a call comes.	<ul style="list-style-type: none"> ● Is "Set mute seconds" of "Ringing time" set to longer time (such as 99 seconds)? Set "Set mute seconds" to shorter time. 	p.140

Problem	Points to check	See page
The records of dialed calls/received calls, redial, received address /sent address disappear automatically.	<ul style="list-style-type: none"> ● Is "Keypad dial lock" set? ● Is "PIM lock" set? 	<p>p.205</p> <p>p.204</p>
The Neuropointer does not move quickly.	<ul style="list-style-type: none"> ● Adjust the slide setting. 	p.253
A different ring tone sounds from what is set up when you receive a call.	<ul style="list-style-type: none"> ● If incoming call settings of each function overlap, a ring tone sounds in the following priority. ① has the highest priority. <ul style="list-style-type: none"> ① The ring tone of the Utilities ② The ring tone of the Group Utilities ③ The Select ring tone 	<p>p.120</p> <p>p.163</p>
A different ring tone sounds from what is set up when you receive mail.	<ul style="list-style-type: none"> ● If incoming call settings of each function overlap, it will operate in the following priorities. ① has the highest priority. <ul style="list-style-type: none"> ① The mail ring tone of the Utilities ② The mail ring tone of the Group Utilities ③ The mail of Select ring tone 	<p>p.120</p> <p>p.163</p>
A different image is displayed from what is set up when you receive a call.	<ul style="list-style-type: none"> ● If incoming call settings of each function overlap, it will operate in the following priorities. ① has the highest priority. However, if an i-motion operates as a ring tone, the i-motion will appear. <ul style="list-style-type: none"> ① The i-motion set for the phonebook registration image ② The incoming call image of the phonebook function ③ The incoming call image of the Group Utilities ④ The Display phonebook image ⑤ The display settings 	<p>p.108</p> <p>p.120</p> <p>p.163</p> <p>p.177</p> <p>p.181</p>
A different incoming call lamp by the color or flashing pattern from what is set up glows when you receive a call	<ul style="list-style-type: none"> ● If incoming call illumination settings of each function overlap, it will operate in the following priorities. ① has the highest priority. <ul style="list-style-type: none"> ① The incoming call illumination settings of the Utilities ② The incoming call illumination settings of the Group Utilities ③ The incoming call illumination settings 	<p>p.120</p> <p>p.185</p>

Problem	Points to check	See page
<p>The ring tone I hear when I receive mail is not the tone I set for mail.</p>	<ul style="list-style-type: none"> ● If a distinctive mail ring tone is set for the mail address, that ring tone sounds instead. ● If a distinctive ring tone is set for the group, that ring tone sounds instead. ● If a distinctive ring tone is set for the mail address and the group, the ring tone set to the mail address is used instead. ● If you have received multiple mails and a distinctive ring tone was set for the last mail to be downloaded, the tone set for that mail address sounds. <hr/> <ul style="list-style-type: none"> ● If the sender's mail address is in the "(phone number)@docomo.ne.jp" format, store only that phone number as mail address and set a distinctive ring tone for that mail address. ● Is the sender's mail address (the mail address shown in the received mail details screen) stored in the Phonebook correctly and did you set a distinctive ring tone for that mail address? <hr/> <ul style="list-style-type: none"> ● If you receive SMS, a distinctive ring tone set for the phone number in the Phonebook sounds. 	<p>p.120</p> <hr/> <p>p.108 p.120</p> <hr/> <p>—</p>
<p>When illumination flashes for incoming mail, the color is not the color I specified.</p>	<ul style="list-style-type: none"> ● If a distinctive mail illumination is set for the mail address that illumination flashes. ● If a distinctive mail illumination is set for the group, that illumination flashes. ● If distinctive mail illumination is set for the mail address and the group, the illumination set to the mail address flashes. ● If you have received multiple mails and a distinctive mail illumination was set for the last mail to be downloaded, the illumination for that mail address flashes. <hr/> <ul style="list-style-type: none"> ● If the sender's mail address is in the "(phone number)@docomo.ne.jp" format, store only that phone number as the mail address and set a distinctive mail illumination for that mail address. ● Is the sender's mail address (the mail address shown in the received mail details screen) stored in the Phonebook correctly and did you set a distinctive mail illumination for that mail address? <hr/> <ul style="list-style-type: none"> ● If you receive SMS, a distinctive illumination set for the phone number in the Phonebook flashes. 	<p>p.120</p> <hr/> <p>p.108 p.120</p> <hr/> <p>—</p>
<p>The mail ring tone sounds but no mail is received.</p>	<ul style="list-style-type: none"> ● Is "Notify tone message" set? The mail ring tone sounds to notify that the number of voice mails increases 1 or more additional voice mails were recorded while you were outside the service area or the FOMA terminal was powered off, and then you come in the service area again or turn on the FOMA terminal. 	<p>p.276</p>

Problem	Points to check	See page
The FOMA terminal cannot be charged (The charge indicator does not turned on).	<ul style="list-style-type: none"> ● Is the battery pack properly attached to the FOMA terminal? ● Is the adapter firmly plugged into the electrical socket or cigarette lighter socket? ● Is the adapter properly attached to the FOMA terminal? (If you are using the AC adapter, make sure that the AC adapter connector is firmly plugged into the FOMA terminal or desktop holder). 	<p>p.56</p> <p>p.58</p> <p>p.59</p> <p>p.60</p>
The key does not sound when I press them (No key tone).	<ul style="list-style-type: none"> ● Is "Keypad sound" set to "OFF"? ● Is the FOMA terminal set to Manner mode? 	<p>p.168</p> <p>p.135</p>
I cannot answer voice call/videophone calls using Any key answer.	<ul style="list-style-type: none"> ● Is "Answer setting" set to "Quick silent" or "OFF"? ● You cannot answer videophone calls using Any key answer. 	p.159
The other party's voice is difficult to hear during calls.	<ul style="list-style-type: none"> ● Is the earpiece speaker placed properly against your ear? ● Is anything such as seal obstructing the earpiece speaker? ● Is anything obstructing the speaker during handsfree? ● Did you change the "Volume" setting? Try changing this setting until you can hear the other party clearly. 	<p>p.32</p> <p>p.78</p>
The other party's voice is too high during calls.	<ul style="list-style-type: none"> ● Did you change the "Volume" setting? Try changing this setting until you can hear the other party clearly. 	p.78
The other party cannot hear me.	<ul style="list-style-type: none"> ● Is anything obstructing the mouthpiece? 	p.32
The message "All lock" and the "🔒" mark appear.	<ul style="list-style-type: none"> ● Enter your security code, and then press  to cancel All lock. 	p.200
I cannot operate the FOMA terminal using the side keys when it is folded.	<ul style="list-style-type: none"> ● Is "Side keys guard" set to "ON"? 	p.208
I cannot check missed calls using  "Memo/Check" when the FOMA terminal is folded.	<ul style="list-style-type: none"> ● Is "Info notice setting" set to "OFF"? ● Is "Side keys guard" set to "ON"? 	<p>p.77</p> <p>p.208</p>
The date is displayed in Japanese.	<ul style="list-style-type: none"> ● Is Japanese selected in "Language"? ● Is Clock display set to Japanese? 	<p>p.65</p> <p>p.191</p>
The display is dim.	<ul style="list-style-type: none"> ● Is the brightness setting of the display light set to "Level 1"? 	p.183
The display, indicator display and display light of the keypad do not turn on.	<ul style="list-style-type: none"> ● Is Lighting of the display light set to "OFF"? ● Hold down  for 1 second or more to turn the display light on or off. Please note that the display light turns off when you hold down  for 1 second or more during operation such as creating a mail. 	<p>p.183</p> <p>p.34</p>
"  " appears when you try to display an image.	<ul style="list-style-type: none"> ● "" may also be displayed if the image data are broken. 	—

Problem	Points to check	See page
The motion of the screen during a videophone call is not smooth.	<ul style="list-style-type: none"> ● Is "Change display size" of "Select image V-phone" set to "Main display size"? ● Set it to "Real size". 	p.100
When I receive an incoming call immediately after turning on the power, the phone number is displayed but the name stored in the Phonebook is not.	<ul style="list-style-type: none"> ● The FOMA terminal may be reading the FOMA card immediately after turning on the power. The Phonebook function may not be available during that time. 	—
It takes some time for the power to turn on after  has been held down for 1 second or more.	<ul style="list-style-type: none"> ● When Phonebook, etc. has reached full capacity, data verification takes some time. 	p.134
The call does not finish even if I press  .	<ul style="list-style-type: none"> ● This may happen when you perform operations using keys () to () , () and () according to the recorded announcement. In this case, press  again. 	—
Nothing appears on the display and  and  are flashing.	<ul style="list-style-type: none"> ● The FOMA terminal is in Power saver mode. Press any keys to cancel Power saver mode. 	p.183
No incoming call reaction (ring tone sounding, vibrator, incoming call lamp flashing) happens when a call comes.	<ul style="list-style-type: none"> ● No incoming call reaction (ring tone sounding, vibrator, incoming call lamp flashing) happens until the set time has passed when you receive a call from a phone number not stored in the Phonebook or from a caller who does not notify its caller ID, if "Set mute seconds" of "Ringing time" is set to other than 0 second. 	p.140

Resetting to the Default Settings

To reset the FOMA terminal to the default settings, perform following steps:

1 Execute “Reset settings”.

See p.254 for details as to how the “Reset settings” is done and what function it would reset.

2 Execute “Reset last URL” and “Reset settings”.

See p.126 in 『Application』 as to how the “Reset last URL” and “Reset settings” are done and what function they would reset.

3 Execute “Reset settings”.

See p.238 in 『Application』 as to how the “Reset settings” are done and what function it would reset.

4 Delete or reset data for each of the following functions:

- Phonebook →p.128
- Group setting of Phonebook →p.129
- Redial →p.73
- Dialed calls/Received calls →p.151
- Send address list/Received address list →p.154
- Pause dial →p.147
- Desktop icons →p.175
- Call duration/Total call time →p.162
- Alarm clock →p.215
- Schedule →p.226
- ToDo →p.232
- Text memo →p.236
- Record message →p.248
- Voice memo →p.248
- Voice announce →p.250
- Own number →p.242
- Common phrases →p.325
- Own dictionary →p.322
- DL dictionary →p.323
- Learning dictionary →p.331
- i-appli →p.90 in 『Application』
- Mail →p.217 in 『Application』
- Message →p.111 in 『Application』
- Mail address →p.245 in 『Application』
- Mail member →p.162 in 『Application』
- Image →p.314 in 『Application』
- Movie/i-motion →p.330 in 『Application』
- Melody →p.344 in 『Application』
- Original animation →p.312 in 『Application』
- Dictionary →p.237



List of Error Messages

When error messages are displayed during operation, handle appropriately referring to the following list.

● i-mode, mail and multimedia-related error messages are described in p.480 in 『Application』.

Error message	Description/Handling	See page
"Invalid UIM requested service not available."	<ul style="list-style-type: none"> ● This message is displayed when you try to execute the desktop icon for data secured by the FOMA card operation restriction function. ● This message is displayed when you try to execute Screen memo and Msg. Request/Free secured by the FOMA card operational restriction function. 	p.53
"Reading UIM Cannot operate"	<ul style="list-style-type: none"> ● This message is displayed if you attempt to perform operations related to the FOMA card while the FOMA card is being read. Retry the operation after a while. 	—
"Insert UIM"	<ul style="list-style-type: none"> ● This message is displayed when the FOMA card may either be improperly inserted or damaged. Check whether the FOMA card is properly inserted. 	p.51
"Setting PIM lock"	<ul style="list-style-type: none"> ● This message is displayed when an invalid operation is attempted while setting PIM lock. 	p.204
"PIN1 code blocked"	<ul style="list-style-type: none"> ● This message is displayed when the power is turned on during PIN1 code lock. Press  [Select] to display the PUK code entry screen. Then, enter the PUK code properly to cancel the lock. 	p.198
"PUK code blocked"	<ul style="list-style-type: none"> ● This message is displayed if you attempt to power on or perform operations related to the FOMA card while the PUK code is locked. Please contact a DoCoMo shop. 	p.194
"Invalid URL"	<ul style="list-style-type: none"> ● This message is displayed when you enter the wrong URL or the wrong number of characters which exceeds the allowable number. 	—
"Phonebook is full"	<ul style="list-style-type: none"> ● This message is displayed when you attempt to add the 701st phone number or mail address to a FOMA terminal (main unit) Phonebook. Delete an unneeded phone number or mail address already stored in the Phonebook before adding the new one. 	p.128
"No data"	<ul style="list-style-type: none"> ● This message is displayed when there is no Phonebook that matches the search conditions when performing Phonebook search. 	p.116
"This UIM cannot be recognized"	<ul style="list-style-type: none"> ● This message is displayed when the FOMA card that cannot be used for the FOMA terminal has been inserted. Check that the correct FOMA card is inserted. 	p.54
"Secret data"	<ul style="list-style-type: none"> ● This message is displayed when you try to search for a memory number specifying a secret data number during the mode other than secret mode or secret only mode. ● This message is displayed when you try to dial secret data with two-touch dialing during the mode other than secret mode or secret only mode. 	p.201

Error message	Description/Handling	See page
"Call acceptance Already set full" "Call rejection Already set full" "Call forwarding Already set full" "Restrict dialing Already set full" "Voice mail Already set full"	● These messages are displayed if you attempt to add the setting to Phonebook when 20 items have already been set in the Phonebook. Perform the desired setting again after canceling the unnecessary Phonebook settings.	p.141
"Setting restrict dialing"	● This message is displayed when an invalid operation is attempted while setting Restrict dialing.	p.141
"Please wait"	● Calling restricted. Use a voice or videophone call after a brief interval.	—
"Other function active Cannot operate"	● This message is displayed when calling up to a menu function that cannot be used is attempted while another function is running.	p.267
"Setting self mode"	● This message is displayed when an invalid operation is attempted while setting Self mode.	p.207
"Service unavailable"	● This message is displayed if you perform network service operation when you are outside the service area or where radio waves cannot reach. Perform network service operation after moving to an area where "☎" is displayed.	—
"Setting keypad dial lock"	● This message is displayed when an invalid operation is attempted while setting Keypad dial lock.	p.205
"Wrong security code"	● This message is displayed when an incorrect security code is entered for a function that requires the security code. Enter the correct security code. If you have forgotten your security code, you need to present your FOMA terminal and an ID such as a driver's license providing that you are the person stipulated in the contract to a DoCoMo shop.	p.192
"Calling now Cannot operate" "Calling now Cannot operate"	● This message is displayed when operation of a function that cannot be performed during calls is attempted.	p.267
"Calling now Cannot operate"	● This message is displayed when Task menu is displayed during a call and a function that cannot be used is selected.	p.268
"Desktop icon is full"	● This message is displayed when you attempt to paste the 16th desktop icon on the stand-by display. Delete any unneeded desktop icons before pasting it.	p.175
"Forwarding number is not set"	● This message is displayed when you have subscribed to the "call forwarding service" and try to forward an incoming call by selecting "Call forwarding" from the Function menu without setting the forwarding destination.	p.293
"Set time"	● This message is displayed when you try to operate the function that cannot be used unless the time is set in "Set time" but the time is not set in "Set time". Set the time and date in "Set time" in advance.	p.65

Error message	Description/Handling	See page
"Enter correct network security code"	<ul style="list-style-type: none"> ● This message is displayed when an incorrect NW security code is entered for a function that requires the NW security code. Enter the correct NW security code. If you have forgotten your NW security code, you need to present your FOMA terminal and an ID such as a driver's license providing that you are the person stipulated in the contract to a DoCoMo shop. 	p.192
"Memory No. : X X X Cannot overwrite"	<ul style="list-style-type: none"> ● This message is displayed when you attempt to add Phonebook to the same number as a memory number for Phonebook added as secret data when the "Secret mode" or "Secret only mode" is not set. 	p.201
	<ul style="list-style-type: none"> ● This message is displayed when you attempt to add Phonebook to the same number as a memory number for Phonebook set to Automatic display. Press  [Select] to return to the Phonebook edit screen. Select "", and enter a vacant memory number to add it. 	p.119
"Switching failed -Other phone busy"	<ul style="list-style-type: none"> ● This message is displayed when the other phone (terminal) is busy and the dual network switching cannot be performed. Perform switching after ending communication of the terminal that is being used. 	p.287

Warranty and After-Sales Service

Warranty

- Make sure that the warranty card is included with your FOMA terminal at the time of purchase. Check that the name of the retailer, the date of purchase, and the necessary details have been filled in on the warranty card, and be sure to keep it in a safe place. If any necessary item on the warranty card is not completed, contact the shop where you purchased the FOMA terminal and request that they complete it. The warranty period is for one year from the date of purchase.
- For the purpose of improvement, the specifications for this product and its accessories are subject to complete or partial change without prior notice.

After-sales service

If you have problems with your FOMA terminal

Refer to the "Malfunction Checklist" section of this manual to see if the solution to your problem is discussed there before bringing your FOMA terminal in for repair.

If the FOMA terminal still malfunctions, contact NTT DoCoMo at any of the following numbers:

○ Inquiries (NTT DoCoMo Group):

From an ordinary (landline) phone:



0120-005-250 (toll free) (in English)

- ※ You can call this number from any type of phone, including DoCoMo mobile phones and PHS phones.
- ※ Check the phone number carefully before dialing.

From a DoCoMo mobile phone or PHS phone:

113 (no area code) (toll free) (in Japanese only)

- ※ You cannot call this number from an ordinary (landline) phone.

※ For details, refer to the "Service station list" provided with the FOMA terminal.

If, after contacting DoCoMo, you are informed that your FOMA terminal is in need of repairs

Bring your FOMA terminal to a designated repair shop. The repair shop is only open during business hours. Remember to bring your warranty card with you.

■ During the warranty period

- The FOMA terminal will be repaired free of charge in accordance with our written warranty policy.
- Please be sure to have the warranty card with you when requesting repairs. Charges apply in the following cases even during the warranty period: no warranty is presented; failure and/or damage were due to incorrect handling.
- Charges apply even during the warranty period if the failure is due to the use of devices and/or consumables not specified by DoCoMo.

■ The FOMA terminal may not be able to be repaired in the following cases:

The water exposure seal reacted; corrosion due to exposure to water, condensation or perspiration is found upon investigation; internal boards are damaged or deformed. Charges apply even if the phone can be repaired, as it is no longer under warranty.

■ After the warranty period has expired

Repair will be carried out upon request. Note that charge will apply for such work.

■ The stocking of replacement parts

Replacement parts (required for maintaining the functionality of the FOMA terminal) will be kept in stock for a minimum of 6 years following the termination of production. Repairs to the FOMA terminal will be possible during this period. Repairs may still be possible after this period has passed, depending on the type of malfunction. Contact the phone numbers given above for more information.

IMPORTANT!





- Never attempt to modify the FOMA terminal or its accessories.
 - Doing so may result in fire, injury or malfunction.
 - The technical standards of the FOMA terminals and FOMA cards are strictly controlled by law to avoid potential network malfunctions and cross talks. The use of the FOMA terminals and FOMA cards that do not meet these technical standards is not permitted.
 - If your FOMA terminal has been modified previously (replacement of parts, modification, coating, etc.), it will only be accepted for the repair of a malfunction if it has been restored to its original state (as a standard DoCoMo product). However, repair may be refused depending on the extent of the modification.
 - The user will be charged for the repair of any malfunction or damage caused by such modifications even during the warranty period.
- Never peel off the seal or the model name plate attached to the FOMA terminal.
The seal or plate functions as a certification that the equipment conforms to the prescribed technical standards. If the seal or the plate is removed or replaced, repair may be refused because conformity to the standards cannot be determined.
- Note that the information stored in your FOMA terminal, such as settings of various functions and the total call time, may be lost (reset) if your FOMA terminal is damaged, repaired or otherwise mishandled. If this happens, please re-enter the information or re-specify the settings.
- The FOMA terminal incorporates a magnetic element in the following parts. Prevent a bankcard, etc. from being close to the earpiece speaker since it may be damaged. Location used: Neuropointer key, speaker, earpiece speaker
- If your FOMA terminal is get wet or become moist, you must immediately turn it off, remove the battery pack, bring the FOMA terminal to a repair shop as soon as possible. However, the FOMA terminal may not be able to be repaired depending on its state.

Memory dial (Phonebook function) and Downloaded information

- Note that information you stored in your mobile phone be kept separately in a notebook, etc. Under no circumstances shall NTT DoCoMo be held liable for any loss of or damage to the stored data in your FOMA terminal.
- In the course of repairs to or model change of your mobile phone, data, such as downloaded data, data created by the user or data imported from external sources, may be modified or lost. Furthermore, we may, at their discretion, conduct repairs that entail replacing your mobile phone with an equivalent product, in which event it is not possible to transfer such data in its entirety to the replacement product. We accepts no liability whatsoever for these phenomena.

About Software Update

Check whether software in the FOMA terminal needs to be updated, and download a part of software to update the software by using the i-mode if necessary. If software update is required, we will notify the guidance in the DoCoMo's web page or “お知らせ&ヘルプ” (News & Help) in iMenu.

- The packet communication to update the software will not be charged.
- There are 2 ways to update software as follows:
 - Immediate update : Perform update immediately as you want to update software.
 - Reserved update : Set the date and time you want to perform update, then software will be downloaded and updated automatically on the reservation date and time.
- SSL communication with the server (DoCoMo's site) is performed upon software update.
 - Enable the certificate in advance.
 - About checking/setting the certificate → p.131 in 『Application』
- You can also update software even if the i-mode host is set to a user's host.
- You must completely charge the battery pack before performing software update.
- It is recommended that you perform software update in a location with strong radio wave reception (the reception level indicator shows 3 bars) at stationary state.
- You cannot update software:
 - When FOMA card is not inserted
 - Incorrect usage of FOMA card
 - When PIN is locked
 - When PUK code is locked
 - When date and time is not set
 - While there is an incoming call
 - While receiving mail/SMS/message
 - During a call
 - During videophone call
 - During i-mode connection
 - During 64K data communication
 - During packet communication
 - When self mode is on
 - When PIM lock is on
 - Out of service area
 - When packet dialing is locked
 - While using mova with dual network service
 - When miniSD reader writer function works
 - While other functions are running
- It may take some time to update software (downloading, rewriting).
- You cannot use other functions during software update. However, you can receive voice calls during downloading.
- During software update, mail and Msg. Request/Free cannot be received, and stored in the i-mode center instead.
- The icons such as  and  will be deleted when reloading after updating software. The mails and messages stored in the voice mail service center are not deleted.
- When the software update is completed without operation for confirmation, you will see the desktop icon “ (Update is complete)” on the standby display. If there is any information to be confirmed, you will see “ (Check update result)”. Select “” and enter the security code to see the detail results of the update.

NOTE

- You should not remove the battery pack during software update. Doing so may cause the update to fail. If update fails, “Rewrite failed” is displayed and you cannot operate anything. In that case, contact a designated repair shop.

Checking whether you need software update

1 Select   “Other settings” ▶ “Software update” and enter your security code.

2 Check the notices and whether you need software update.

At that time, you need to send your mobile phone information (such as model and production number of the FOMA terminal) to the server.

However, your mobile phone information sent to DoCoMo will not be disclosed to a third party or diverted.



3 Displays the check result.



When the display is “Update is needed”

Select “Now update / Reserve”.

Select “Now update” to update the software immediately. →p. 377

Select “Reserve” to update on a specified timing. →p. 378



When the display says “No update is needed”

Select “OK”.

Continue using your FOMA terminal as there is no need to update the software.

1 Select “Now update” in the check result display (p. 376). When you see “Start download Notice:”, select “OK”.

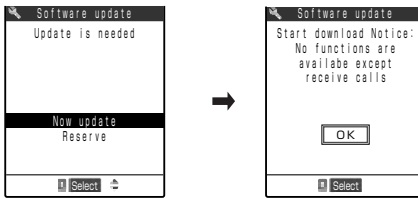

Downloading will start immediately. Download will begin after a while, even if you do not select “OK”.

2 When the download is complete, you will see the message “Download is complete Rewrite software”. Select “OK”.

The software will begin rewriting. Rewrite will begin after a while, even if you do not select “OK”. It may take a time to start rewriting.



All keys are disabled during software rewriting. You cannot even stop rewriting.

When the software rewriting is complete, the FOMA terminal will reload.

After reloading, the terminal will automatically connect to the server to check the update completion.

When you see the message “Software update is complete” select “OK”. That is all for updating software.



NOTE

- When you stop downloading before completion, the data that has been downloaded until then will be deleted.
- Once you start downloading, update will be processed automatically without selecting any items such as menu.
- The display on the right may be shown if the server is busy. In that case, select "Reserve" to perform the reserved update.



Selecting the reservation data and time to update software <reserved update>

If it takes a long time to download or when the server is busy, you can select the time to startup Software update by communicating with the server beforehand.

<Example: Reserving at 7:30 on July 16 (Friday)>

1 Select "Reserve" at check result screen (p. 376) and select the timing.

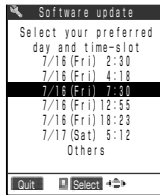

When there are no dates you want to select
to select
Select "Others". →p.379

2 Check the selected date and time, and then select "YES".

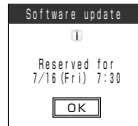

That is all for setting the time for software downloading.
When you want to select all over again
Select "NO".



The screen on the left appears at the reservation time and the FOMA terminal starts the software update automatically. Charge the battery pack fully, put the FOMA terminal at a location with strong radio wave reception and show the standby display before the reservation time. The rest of operation is same as "Updating software immediately".

NOTE

- The timing for the software updates will be based on the server's time.
- When the reserved update ends, the FOMA terminal is automatically reloaded. When PIN1 code entry set (p.195) is set to "ON", PIN1 code entry screen remain displayed during reloading (p.197). Note that incoming calls and mails are not received.
- The software will not begin updating in the following situations, even if the set time comes.
 - When the FOMA terminal power is off
 - Battery shortage
 - When FOMA card is not inserted
 - Incorrect usage of FOMA card
 - PIN is locked
 - PUK code is locked
 - Date and time have not been set
 - Receiving incoming call
 - Receiving mail/SMS/message
 - During a call
 - During videophone call
 - During i-mode connection
 - During 64K data communication
 - During packet communication
 - All lock is on
 - Self mode is on
 - PIM lock is on
 - Out of service area
 - Packet dialing is locked
 - While using mova with dual network service
 - miniSD reader writer works
 - Other functions are running
- When the reservation time for the software update is the same as the alarm notification time, the software update is given priority.

If you select "Others"

You can select the desired date and period of time after communicating with the server if you select "Others" at step 1 in p.378.

1 Reserve a date.

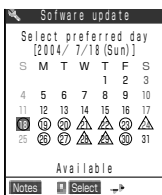

In the selection display, you will see the update availability represented as shown below:

- : Open
- △ : Almost full
- None : Full

2 Reserve a time zone.

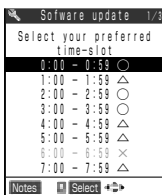

In the selection display, you will see the update availability represented as shown below:

- : Open
- △ : Almost full
- × : Full

Select the period of time that you want to display the candidates for the reservation time by communicating with the server again.

3 Confirm the software update timing.

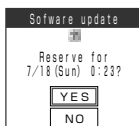

If you check the selected timing and select "YES", you will communicate with the server.

That is all for the update reservation.

<Example: Canceling the reservation after checking it>

1 Select   “Other settings”  “Software update”, and then enter the security code.

2 Select “Cancel”.

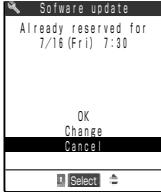

To accept the reservation data and time

Select “OK”.

To change the reservation data and time

Select “Change”.

If you select “Change”, perform the same steps as you select “Others” after sending your mobile phone information (such as model and production number of the FOMA terminal) to the server. →p.379

3 When you see the message “Cancel this reservation?”, select “YES”.

Then the mobile phone information (FOMA terminal model and manufacturer’s number) is sent to the server.

Moreover, we will never disclose or apply your mobile phone information sent to a third party.



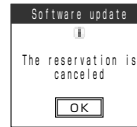
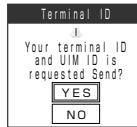































When you see the message “The reservation is canceled”, select “OK”. That is all for canceling the reservation.



A		Call acceptance	141	Scheduled events	226
AC adapter	58	Call duration	161	Text memos	236
Access reader	359	Call forwarding	141	ToDo	232
Accessories	354	Call forwarding service	278	Desktop holder	59
Additional service	295	Call rejection	141	Desktop icon	170
Address record	154	Call setting w/o ID	145	Dialed calls record	151
Adjust	253	Call time display	161	Dictionary	237, 321, 323
Adjusting volume	78, 79	Call waiting service	281	Direct key selection	44
After-sales service	373	Caller ID request service	286	Display	37
Alarm clock	213	Camera	359	Display light	100, 183
Alarm setting	209	Canceling PIN lock	198	Display phonebook image	181
Alarms		Change forwarding No	279	Display setting	177
Alarm clock	209, 213	Change security code	193	Download dictionary	323
Low-voltage alarm	64	Changing the character input mode	326	Driving mode	82
Quality alarm	158	Character entry	300	Dual network service	287
Schedule	209, 216	Copy, cut, paste	319	E	
ToDo	209, 228	Method	326	Earphone	261
Voice announce	249	Switching the screen to operate	338	Earphone/microphone	259
All lock	200	Characters	300	Earphone/microphone with switch	259
Anniversaries	217	Charge sound	169	Edit	
Answer message (Utilities)	120	Check messages	276	Phonebook	119
Answer setting	159	Clear learned	331	Text	316
Any key answer	159	Clock display	191	Edit title	174
Arrival call act	291	Color pattern	182	Edited data	318
At fwd party busy	280	Common phrases	324	Editing Text	316
Automatic answer	262	Component names and functions	32	English guidance	289
Automatic display	125	Copy	130, 319	Entering Common Phrases	313
B		Cut	319	Entering the PIN Code	197
Bar code reader	360	D		Error messages	370
Bar nuisance call service	284	Data being entered	318	F	
Battery level	63	DC adapter	60	Face symbols	311
Battery pack	55	Delete		Flashing incoming call lamp	185
Blocking nuisance call	68	Additional service	297	Flat-type earphone/microphone with switch	261
Byte	340	Desktop icons	175	Fold setting	160
C		FOMA card data	132	FOMA card	51
Calculator	234	Phonebook	128	Add to Phonebook	111
Calendar	217	Redial record	73	Operation Restriction Function	53

Versions	54	Illumination in talk	186	Menu functions	42
Font	190	Image (Utilities)	120	Menu Operations	44
Forwarding image	359	i-mode password	192	Missed alarm (Alarm notification)	212
Frequently used functions (Original menu)	244	Important	374	Missed call	76
Function menu	49	Indicator display	40, 187	Missed call (received calls) record	151
G		Info notice setting	77	Mode 1 (5-touch)	303
Glossary	340	Inserting a space	308	Mode 2 (2-touch)	336
Group setting	128	Insertion mode	305	Mode 3 (T9)	332
Guidance	45, 243, 329	International calls	73	Multi access	263
H		Ir exchange	359	Combination Patterns	351
Hands-free	80	J		Multi task	267
Handsfree (→Making a Videophone call)	88	Jump	318	Combination Patterns	352
High level items	44	K		N	
Hold		Kanji conversion	305	Network services	272
Holding	71	Keypad dial lock	205	Neuropointer	35
On hold	81	Keypad sound	168	Noise reduction	156
Holding	71	Keypad/Charge sound	168, 169	Notify caller ID	66, 124, 285
Holidays	217	Keys	32, 33	Notify tone message	276
I		Kuten code entry	316	Notify your phone number (Notify caller ID)	66, 285
Icon	37	Kuten code list	347	NW security code	192
Battery level	63	L		O	
Changing the title	174	Language	65	On hold	81
Delete	175	Last one function	258	Options	354
Desktop icons	170, 172, 176	Light	32	Original manner	136
Dialed calls record	153	Line feed	309	Original menu	244
Guidance	45, 243	Lists of Common Phrases	346	Overview of the Keypad Character Assignments	
Icons	39	Lock function	199	2-touch input	342
Missed calls record	153	Low-voltage alarm	64	5-touch input	340
Missing a call	176	M		T9 input	341
Notifying information	176	Mail illumination (Utilities)	120	Overwriting mode	305
Received address record	156	Mail member	361	Own dictionary	321
Received calls record	153	Mail ring tone (Utilities)	120	Own number (your phone number)	67, 239
Sent address record	156	Mail/Msg. ring time	355	P	
User icon	220	Malfunction checklist	364	Paste	170, 320
Utilities	121	Manner mode	135	Pause dial	146
Videophone call	87	Operation	136	Personal data	239
Icons	39	Manner mode set	136	Phonebook	106
Illumination	185, 186	Menu display set	243	Delete	128
Illumination (Utilities)	120	Menu function list	355	Edit	119

No. of phonebook	134	Redial	72	Service code	295
Search	116	Register caller	284	Service Dial	290
Store	108	Reject unknown	144	Services	353
Pictograph	312	Remote control	294	Set arrival act	292
Entering continuously	312	Remote monitor	102	Set time	65
PIM lock	204	Reset		Setting Ringing time	140
PIN number	192	Reset call duration	162	Setting the date and time	65
PIN setting	195	Reset settings	254	Setting the Neuropointer	251
PIN1 code	52, 194	Reset call duration	162	Short message service (SMS)	11
PIN1 code entry set	195	Reset desktop	175	Side keys guard	208
PIN2 code	52, 194	Reset settings	254	Silent	
Play/Erase msg.	247	Resetting		Quick silent	159
PLMN (telecommunication carrier)	259	Desktop	175	Super silent	136
Pointer	35, 251	Group name	129	SMS	11
Power On/Off	62	Personal data	242	Snooze setting	214
Prediction	309, 328	Resetting to the Default Setting	369	Software key	34
Prefix setting	149	Restrict dialing	141	Software update	375
Priority input method (→Input method)	326	Restrict outgoing calls	141	Special number	295
Private information	204	Restrictions	141	SRS_WOW setting	358
Q		Check	144	Standby display (Display setting)	177
Quality alarm	158	Set	141	Storing Original menu	244
Quick record message	136	Ring tone (Utilities)	120	Storing a word	321
Quick silent	159	Ring tone/melody list	165	Subaddress setting	150
Quote	315	Ring volume	79	Super silent	136
Quote own number	315	S		Switching between full-pitch/half-pitch	304
R		Schedule	216	Switching between lowercase and uppercase	304
Random melody	164	Scroll pages	47	Symbols	311
Reading candidates	333	SD-PIM	360	Entering continuously	312
Rear panel display (Indicator display)	40	Search phonebook	116	Symbols and Special Characters List	343
Recall	114	Secret code	127	T	
Received address record	154	Secret mode	201	T9 (Mode 3)	332
Received calls records	151	Secret only mode	201	Text memo	234
Reconnect control	157	Security	53	Time	65
Record display set	206	Security code	192	ToDo	228
Record message	84, 247	Register (Change)	193	Tone on (Fold setting)	160
Recording		Select hold tone	158	Total call duration	161
Record message	84	Select ring tone	163	Two-touch dialing	110
Voice announce	249	Self mode	207	U	
Voice memo	246	Sent address record	154	UIM operation	130

USB mode setting	358	 display	37
User icon	220	 display	37
Utilities	120	 display	37
Check	123	 display	37
Set	120	 display	37
Utilities	120	 display	37
V		 display	37
Vibrator	167	 display	37
Videophone call	87	 display	37
Camera Switch (→Receiving a Videophone call)	92	 display	37
Chara-den	94	 display	37
Communication speed	95	 display	37
Display light	100	 display	37
Image quality	97	 display	37
My image sending	98	 display	37
Remote monitor	102	 display	37
Select image	98	 display	37
Select image V-phone	100	 display	37
Substitute image	92, 98	 display	37
Voice call auto switch	95	 display	37
Zoom	96	 display	37
Viewer settings	181	 display	37
Voice announce	249	 display	37
Voice call	70, 75	 display	37
Voice mail	141	 display	37
Voice mail service	273	 display	37
Voice memo	246, 247	 display	37
Volume	78	 display	37
W		 display	37
Wake-up	179	 display	37
Warranty	373	 display	37
WORLD CALL	73	Others	
Z		"186"/"184"	66
Zoom	96	2-touch (Mode 2)	336
Icons		5-touch (Mode 1)	303
 display			37
 display			37
 display			37
 display			37

Using your FOMA Terminal Politely

When using your FOMA terminal in public, don't forget to consider the feelings of the people around you.

Always turn your FOMA terminal off in the following situations:

- In places where the use of mobile phones is prohibited
There are places where the use of mobile phones is prohibited. Always turn your FOMA terminal off in such places.
 - In aircraft • In hospitals
 - ※ Turn off your FOMA terminal even when you are in an area outside hospital wards, such as a hospital lobby or waiting room, since electronic medical equipment may be in use nearby.
- When you are driving
Using your FOMA terminal while you are driving could cause a traffic accident.
 - ※ If you do not want to turn your FOMA terminal off while you are driving, set it to Driving mode.
- When you are in a crowded place such as on trains in case you may be near the people who is using an implantable cardiac pacemaker or implantable cardioverter-defibrillator.
Radio waves may affect the operation of implantable cardiac pacemakers or implantable cardioverter-defibrillators if used in close proximity.
- When you are in public places such as a theater, cinema or gallery
Using your FOMA terminal in public places where quiet is needed can annoy the people around you.

Be aware of where you use the FOMA terminal and the volume of your voice and the ring tone

- Take care not to speak too loudly when you use your FOMA terminal in quiet location such as restaurants and hotel lobbies
- Take care not to obstruct other people when you use your FOMA terminal in shopping areas, etc.

The privacy should be protected

- ! Please be considerate of the privacy of individuals around you when taking and sending photos using camera-equipped mobile phones.

Use these FOMA functions to avoid offending people around you

Your FOMA terminal is equipped with convenient functions that remove the need to answer incoming calls and mute all the sounds made by the FOMA terminal.

[Manner mode/Original Manner mode]

Manner mode mutes the sounds made by the FOMA terminal, such as the keypad sounds and the ring tone. In Original Manner mode, you can also change settings by function, such as the record message, vibrator or ring tone. However, neither Manner mode nor Original Manner mode can mute the shutter sound of the camera.

[Driving mode]

In this mode, the FOMA terminal plays an announcement informing the caller that you are driving and cannot answer the phone, and then terminates the call. This promotes safe driving since the FOMA terminal does not ring.

[Vibrator]

This makes the FOMA terminal vibrate rather than ring when a call comes in.

[Record message function]

When you cannot take calls, this function allows the caller to leave a recorded message.

You can also use optional services such as the Voice mail service (p.273) and Call forwarding service (p.278).



Don't forget your cellular phone ... or your manners!

When using your mobile phone in a public place, don't forget to
show common courtesy
and consideration for others around you.

Sales: NTT DoCoMo Group

NTT DoCoMo Hokkaido, Inc.	NTT DoCoMo Tohoku, Inc.
NTT DoCoMo, Inc.	NTT DoCoMo Tokai, Inc.
NTT DoCoMo Hokuriku, Inc.	NTT DoCoMo Kansai, Inc.
NTT DoCoMo Chugoku, Inc.	NTT DoCoMo Shikoku, Inc.
NTT DoCoMo Kyushu, Inc.	

Manufacturer: NEC Corporation



This manual is made from
100% recycled paper.



This manual is printed
with soy based ink.



Li-ion

For the environmental protection, bring the exhausted battery to
the nearest DoCoMo, dealers, or the recycle shop.