



Register your new Bosch now:  
[www.bosch-home.com/welcome](http://www.bosch-home.com/welcome)



BGN22128GB



en Instruction manual  
zh 使用說明

<b>Safety information</b> .....	<b>4</b>
<b>Your vacuum cleaner</b> .....	<b>6</b>
<b>Replacement parts and accessories</b> .....	<b>7</b>
<b>Before using for the first time</b> .....	<b>8</b>
<b>Initial use</b> .....	<b>8</b>
<b>Vacuuming</b> .....	<b>10</b>
<b>After using the appliance</b> .....	<b>11</b>
<b>Using the dust bag</b> .....	<b>11</b>
<b>Using the dust container</b> .....	<b>12</b>
<b>Malfunctions</b> .....	<b>15</b>
<b>Filter care</b> .....	<b>15</b>
<b>Care</b> .....	<b>16</b>
<b>Customer Service</b> .....	<b>17</b>
<b>Disposal information</b> .....	<b>18</b>
<b>Conditions of guarantee</b> .....	<b>19</b>

安全信息 .....	20
您的真空吸尘器 .....	21
替换部件和专用附件 .....	22
首次使用前 .....	24
初次使用 .....	24
真空吸尘 .....	26
使用电器后 .....	27
使用集尘袋 .....	27
使用集尘容器 .....	28
故障 .....	31
过滤器保养 .....	31
保养 .....	32
客户服务 .....	33
棄置資訊 .....	34

## Safety information

Please keep this instruction manual. When passing the vacuum cleaner on to a third party, please also pass on this instruction manual.

### Intended use

This appliance is intended for domestic use only. This appliance is intended for use up to a maximum height of 2000 metres above sea level. Only use this vacuum cleaner in accordance with the instructions in this instruction manual.

#### In order to prevent injuries and damage, the vacuum cleaner must not be used for:

- Vacuum-cleaning persons or animals
- Vacuuming up:
  - hazardous, sharp-edged, hot or glowing substances.
  - damp or liquid substances.
  - highly flammable or explosive substances and gases.
  - ash, soot from tiled stoves and central heating systems.
  - toner dust from printers and copiers.

### Spare parts, accessories, dust bags

Our original spare parts, original (special) accessories and original dust bags are designed to work with the features and requirements of our vacuum cleaners. We therefore recommend that you only use our original spare parts, original (special) accessories and original dust bags. This will ensure that your vacuum cleaner has a long service life and that the quality of its cleaning performance will remain consistently high throughout.

#### ! Please note

- Using unsuitable or inferior-quality spare parts, (special) accessories and dust bags can damage your vacuum cleaner. Damage caused by the use of such products is not covered by our guarantee.

## Safety information

This vacuum cleaner complies with the recognised rules of technology and the relevant safety regulations.

- The appliance may be used by children over the age of 8 years and by persons with reduced physical, sensory or mental capacity or by persons with a lack of experience or knowledge if they are supervised or have been instructed on the safe use of the appliance and the have understood the potential dangers of using the appliance.
- Children must never play with the appliance.

- Cleaning and user maintenance must never be carried out by children without supervision.
- Plastic bags and films must be kept out of the reach of children before disposal.  
=> Risk of suffocation.

### Proper use

- Only connect and use the vacuum cleaner in accordance with the specifications on the rating plate.
- Never vacuum without the dust bag or dust container, motor protection or exhaust filter.  
=> This may damage the vacuum cleaner.
- Always keep the vacuum cleaner away from your head when using nozzles and tubes.  
=> This could cause injury!
- When vacuuming stairs, the appliance must always be positioned below the user.
- Do not use the power cord or the hose to carry or transport the vacuum cleaner.
- For safety reasons, if this appliance's mains power cable becomes damaged, it must be replaced by the manufacturer, their after-sales service department or a similarly qualified person.
- If using the appliance for longer than 30 minutes, pull out the power cord completely.
- When disconnecting the appliance from the mains, pull on the plug itself to remove it; do not pull on the power cord.
- Do not pull the power cord over sharp edges or allow it to become trapped.
- When the cable is being automatically rewound, ensure that the mains plug is not thrown towards persons, body parts, animals or objects.  
=> Use the mains plug to guide the power cord.
- Pull out the mains plug before carrying out any work on the vacuum cleaner.
- Do not operate the vacuum cleaner if it is damaged. Unplug the appliance from the mains if a fault is detected.
- For safety reasons, only authorised after-sales service personnel are permitted to carry out repairs and fit replacement parts to the vacuum cleaner.
- Protect the vacuum cleaner from the weather, moisture and sources of heat.
- Do not pour flammable substances or substances containing alcohol onto the filters (dust bag, motor protection filter, exhaust filter, etc.).
- The vacuum cleaner is not suitable for use on construction sites.  
=> Vacuuming up building rubble could damage the appliance.
- When not in use, switch off the appliance and pull out the mains plug.
- At the end of its life, the appliance should immediately be rendered unusable, then disposed of in an appropriate manner.

## Safety information

### ! Please note

- The mains socket must be protected by at least a 16 amp circuit breaker.  
If a circuit breaker is tripped when you switch on the vacuum cleaner, this may be because other electrical appliances which have a high current draw are connected to the same power circuit.  
To prevent the circuit breaker from tripping, select the lowest power setting before switching the appliance on, and increase the power only once it is running.

## Notes on the energy label

This vacuum cleaner is a general purpose vacuum cleaner with a primary hose.

These appliances can be operated with either a dust bag or a dust box in the dust compartment. The stated values refer to the appliance when used with a dust bag.

To achieve the declared energy efficiency and cleaning performance class on carpet, please use the interchangeable universal nozzle.

To achieve the declared energy efficiency and cleaning performance class on hard floor with nooks and crannies, please use the hard floor nozzle provided.

**These calculations are based on the Commission Delegated Regulation (EU) No. 665/2013 of 3rd May 2013 supplementing Directive 2010/30/EU. Unless otherwise stated, all the procedures referred to in these instructions were carried out in accordance with the EN 60312-1:2017\* standard.**

\*As the motor service test is carried out with the dust collector empty, the stated motor service life must be increased by 10% for tests with the dust collector half filled.

## Your vacuum cleaner

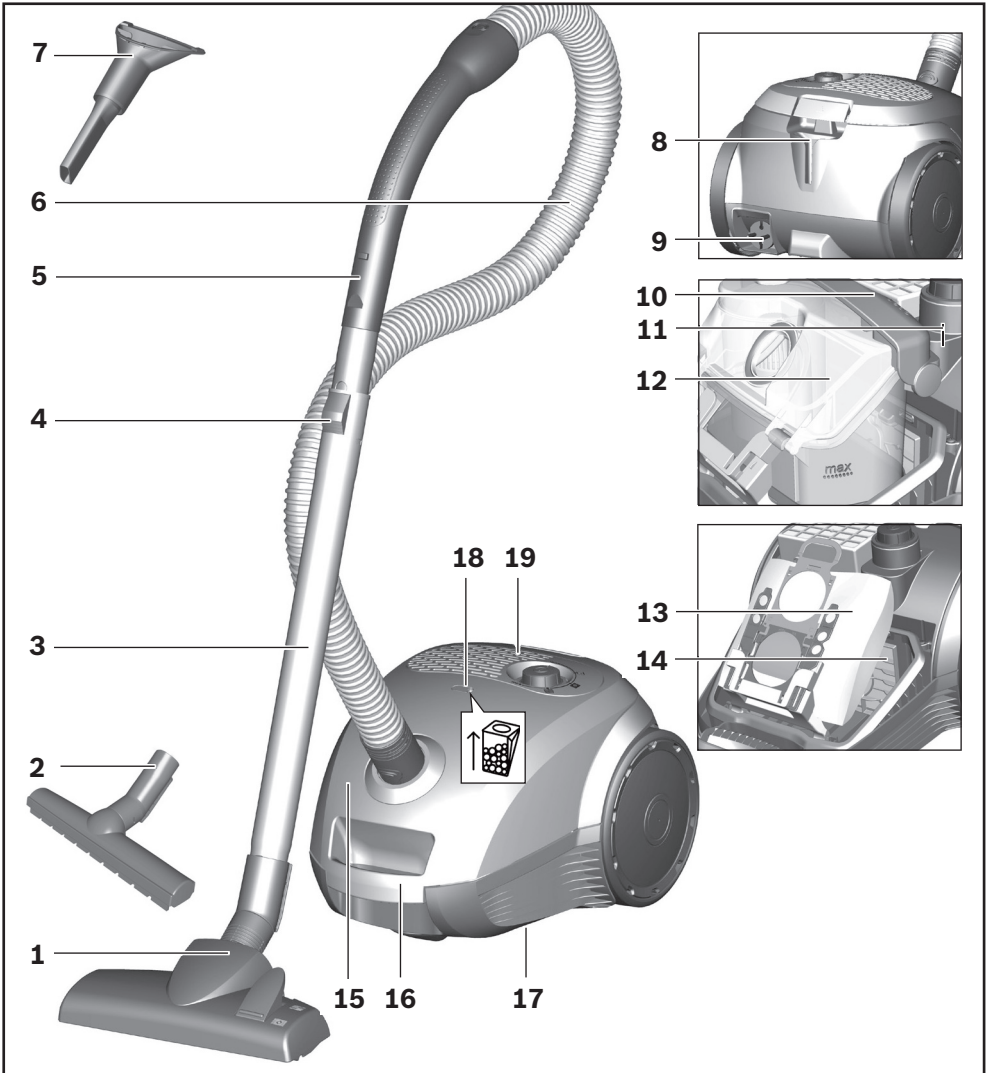

- 1 Adjustable floor tool\*
- 2 Hard-floor tool\*
- 3 Telescopic tube\*
- 4 Sliding switch\*
- 5 Handle\*
- 6 Flexible hose
- 7 Multi-purpose nozzle
- 8 Parking aid
- 9 Power cord
- 10 Exhaust filter

- 11 On/Off button with electronic suction regulator\*
- 12 Dust container\* for using the vacuum cleaner without dust bags or an alternative dust bag\*
- 13 Dust bag
- 14 Motor protection filter, washable
- 15 Dust bag compartment lid
- 16 Carrying handles
- 17 Storage aid (on the underside of the appliance)
- 18 Dust bag change indicator\*
- 19 Exhaust grille

## Replacement parts and accessories

**A**

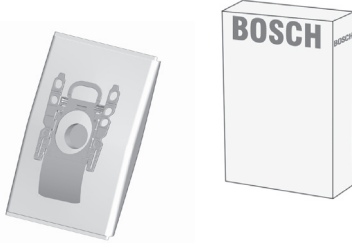

### **A Replacement filter package**

To get the most out of your appliance, we recommend using PowerProtect genuine replacement bags (BBZ41FGALL).

Contents:

- 4 dust bags with fasteners
- 1 micro-hygiene filter

### **! PLEASE NOTE**

We therefore recommend that you only use our original dust bags.

Your appliance is a highly efficient vacuum cleaner that achieves excellent cleaning results when used with high-quality dust bags. Only by using high-quality dust bags (such as Bosch original dust bags) can you ensure that your vacuum cleaner is working at the energy efficiency class, dust pick-up rate and dust retention capacity listed on its EU energy label. The use of inferior-quality dust bags (e.g. paper bags) can have a negative effect on the service life and performance of your appliance. Using unsuitable or inferior-quality dust bags can also damage your vacuum cleaner. Such damage is not covered by our guarantee.

You can find more information about this at

[www.bosch-home.com/dust-bag](http://www.bosch-home.com/dust-bag). You can order our original vacuum cleaner bags here.

**B**

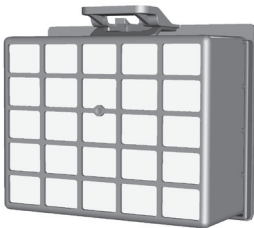

### **B EPA filter BBZ156HF**

Additional filter for cleaner exhaust air.

Recommended for allergy sufferers. Replace once a year.

**C**

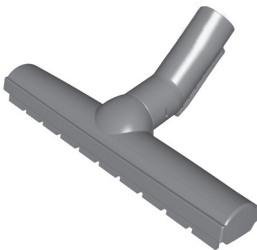

### **C Hard-floor tool BBZ123HD**

For vacuuming hard floors (parquet, tiles, terracotta, etc.)

## Before using for the first time

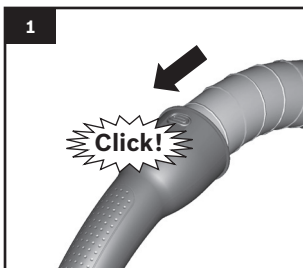

**Figure 1**

- Push the handle onto the flexible hose and lock it in place.

## Initial use

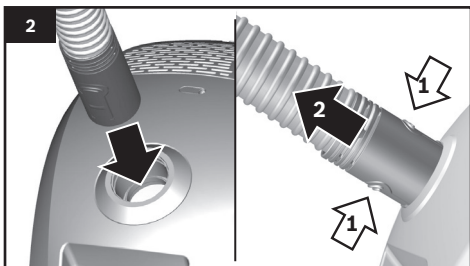

**Figure 2**

- Push the flexible hose connecting piece into the air intake opening in the lid until it locks in place.
- To remove the flexible hose, press the two locking catches together and pull out the hose.

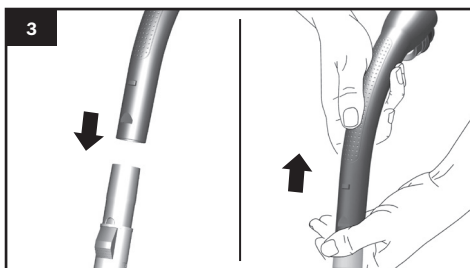

**Figure 3**

- Push the handle into the suction/telescopic tube.
- To remove it, turn the handle slightly and pull it out of the tube.

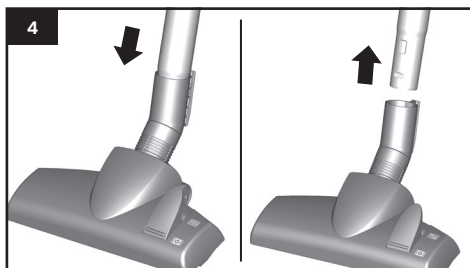
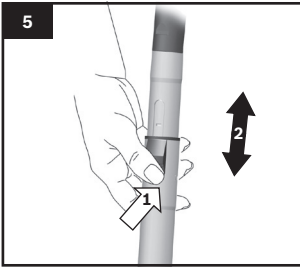

**Figure 4**

- Push the suction/telescopic tube into the connecting piece of the floor tool.
- To release the connection, turn the tube slightly and pull it out of the floor tool.



## Initial use



**Figure 5**

- Unlock the telescopic tube by moving the sliding switch in the direction of the arrow and adjust it to the desired length.

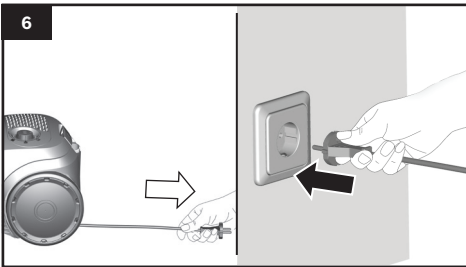

**Figure 6**

- Holding the power cord by the plug, pull it out to the required length and insert the plug into the mains socket.

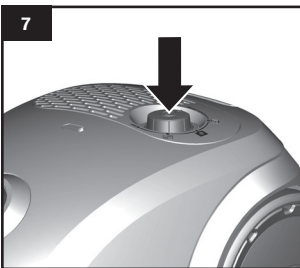

**Figure 7**

- To switch the vacuum cleaner on or off, press the On/Off button in the direction of the arrow.

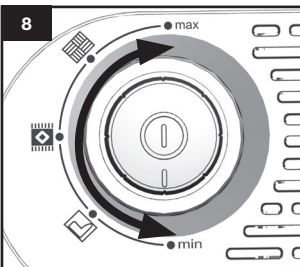

### Controlling the suction level

**Figure 8**

Set the suction level by turning the On/Off button in the direction of the arrow.

The suction level can be infinitely adjusted to the level required by turning the control knob in the direction of the arrow.

min - For vacuuming curtains and delicate textiles

 - For vacuuming upholstered furniture and cushions

 - For vacuuming delicate rugs and for daily vacuuming of lightly soiled floors

 - For vacuuming durable floor coverings

max - For vacuuming hard floors and heavily soiled rugs and carpets

## Vacuuming

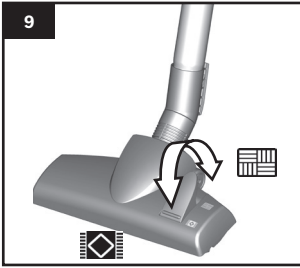

**Figure 9**  
Adjusting the floor tool:

- Rugs and carpets
- Hard floors



**Please note:**

Floor tools are subject to a certain amount of wear, depending on the type of hard floors you have (e.g. rough, rustic tiles). You must therefore check the underside of the floor tool at regular intervals. Worn undersides of floor tools may have sharp edges that can damage delicate hard floors, such as parquet or linoleum. The manufacturer does not accept any responsibility for damage caused by worn floor tools.

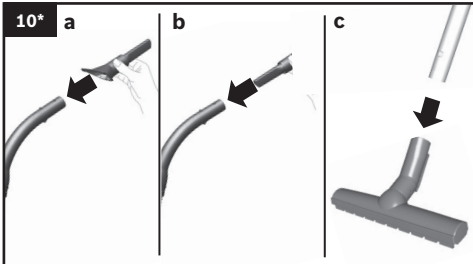

**Figure 10\*** Vacuuming with accessories

Attach the nozzles to the suction pipe or handle as required:

- a) Crevice nozzle for vacuuming crevices and corners, etc.
- b) Upholstery nozzle for vacuuming upholstered furniture, curtains, etc.
- c) Hard-floor tool  
For vacuuming hard floor coverings (tiles, parquet, etc.)

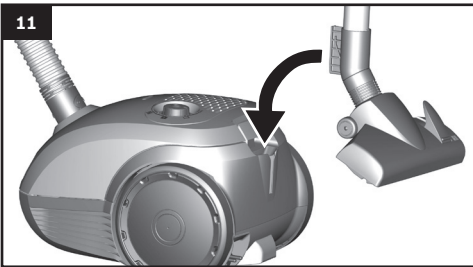

**Figure 11**

You can use the parking aid on the side of the appliance if you wish to stop vacuuming for a short time. After switching off the appliance, slide the hook on the floor tool into the recess on the side of the appliance.

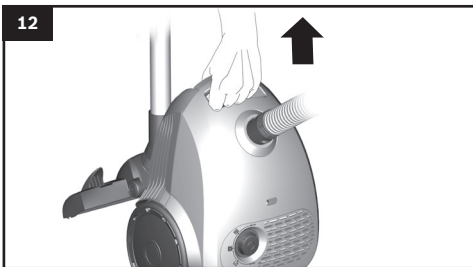

**Figure 12**

When vacuuming on stairs for example, the appliance can also be carried by the handle.

## After using the appliance

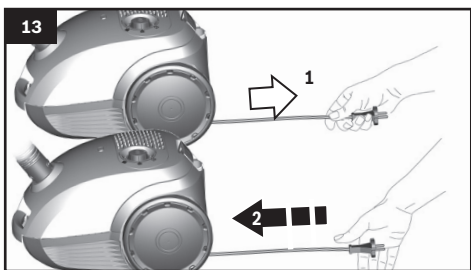

**Figure 13**

- Pull out the mains plug.
- Briefly pull on the power cord and then release it (the power cord retracts automatically).

**Figure 14**

To store/transport the appliance, you can use the storage aid on the underside of the appliance. Stand the appliance up on its end. Slide the hook on the floor tool into the recess on the underside of the appliance.

You have purchased a floor vacuum cleaner which can vacuum up any type of dry dirt using the dust container or dust bag.

We recommend that you use:

- The dust bag principally for everyday household cleaning.
- The dust container for DIY-related cleaning in particular, e.g. to vacuum up wood shavings, etc.

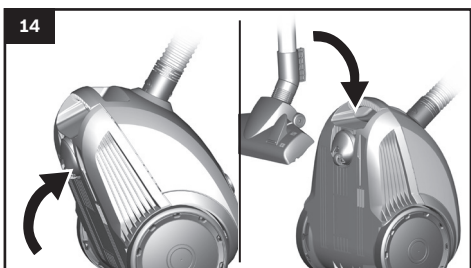

## Using the dust bag



### Replacing the dust bag

**Figure 15**

- If the dust bag change indicator in the lid is filled completely when the floor tool is lifted from the floor with the highest suction level selected, the dust bag must be changed, even though it may not yet be full. Even if the dust bag is not full, it may still need changing, due to the type of dust which has been vacuumed.

First check that the nozzle, suction pipe and flexible hose are not blocked, as this would also lead to the dust bag change indicator being triggered.

**Figure 16**

- Unlock the lid by releasing the locking lever in the direction of the arrow.

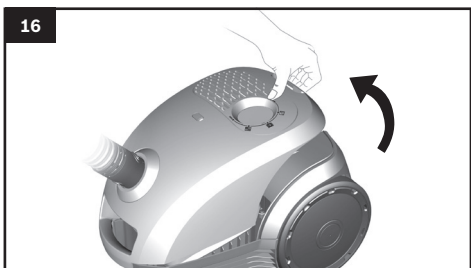

## Using the dust bag

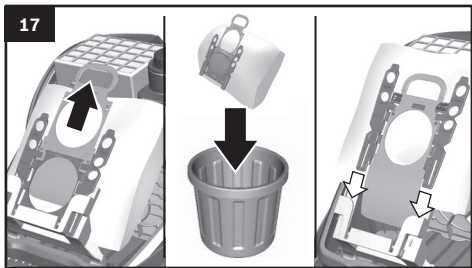
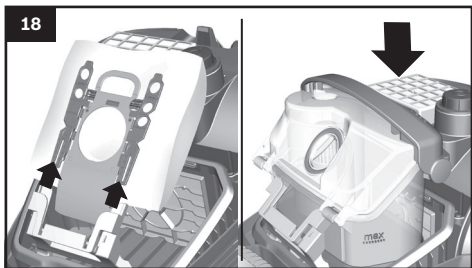

**Figure 17**

- Close the dust bag by pulling on the locking tab and then remove it.
- Insert a new dust bag by pushing it fully into the holder.

❗ **Please note: The lid will only close if a dust bag has been inserted.**

## Using the dust container



If necessary, a dust container can be used in place of a dust bag.

❗ **Please note: The dust bag change indicator only works in conjunction with a dust bag.**

**Figure 18**

- Open the dust bag compartment lid.
- Remove the dust bag and insert the dust container.
- Close the appliance lid.

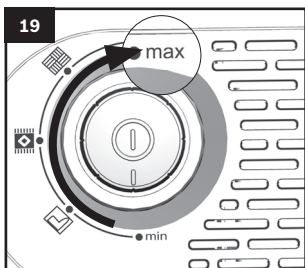

**Figure 19**

Set the power setting to maximum for best results when vacuuming.

We recommend that you reduce the setting only when vacuuming very delicate materials.

### Emptying the dust container

In order to achieve the best possible vacuuming results, the dust container should be emptied after every use or, at the latest, when dust at one point in the container has reached the **max** marking.

When emptying the dust container, always check the soiling level of the foam filter in the bottom of the container.

When it is visibly soiled, clean the filter as described from [figure 24](#) onwards.

**Figure 20**

- Open the dust bag compartment lid by moving the locking lever in the direction of the arrow.

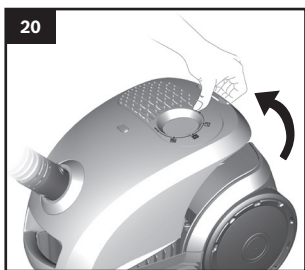

## Using the dust container

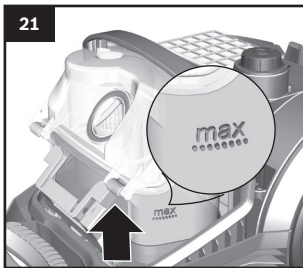

Figure 21

- Remove the dust container from the appliance.



Figure 22

- Fold the carrying handle backwards, away from the air intake opening.
- Remove the cover from the container and put it to one side.
- Empty the container.
- Hook the cover into the container and then close it.
- Fold up the carrying handle and lock it in place on the cover.

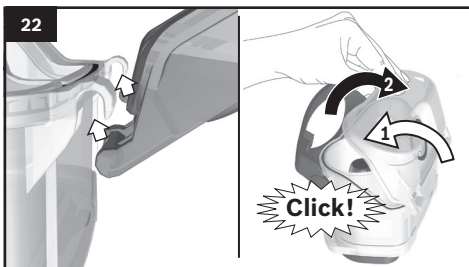
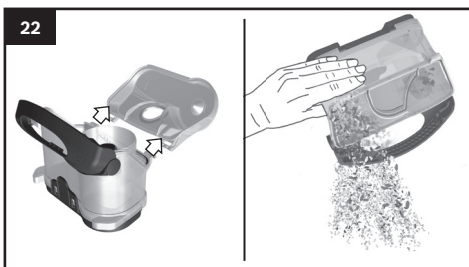

## Using the dust container

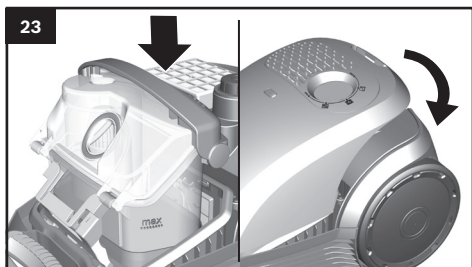

Figure 23

- Reinsert the dust container into the appliance and close the dust bag compartment lid.
- ! **Please note: The inside of the dust container may become scratched with use and start to look opaque. This does not, however, affect the performance of the vacuum cleaner in any way, i.e. it will continue to function as normal.**

### Cleaning the filter fleece (a) and the foam filter (b) in the dust container

The filter must be cleaned:

- After any malfunctions, i.e. after a blockage is cleared
- If there is visible dirt on the filter
- At least every three months

Figure 24

- Unlock the locking tab on the rear side of the container and open the base plate on the bottom of the container.
- Remove both filters (a + b) from the base plate.

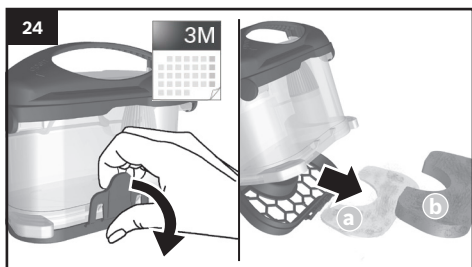
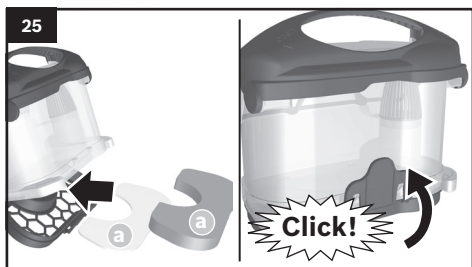
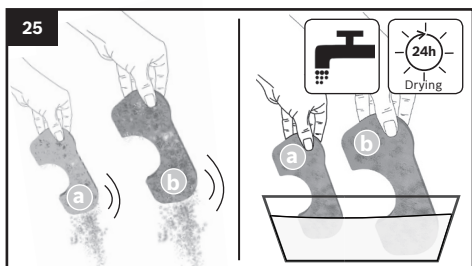

Figure 25

- Wash out both filters (a + b) and leave them to dry for at least 24 hours.
- After cleaning them, insert both filters into the base plate.
- Close the base plate and push in the locking tab until you hear it click into place.

- ! **Note: When inserting the filters, you must follow the correct sequence. The foam filter (b) must lie on top of the filter fleece (a).**



## Malfunctions

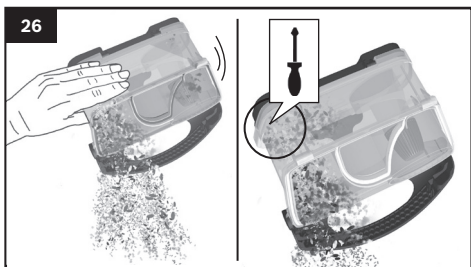

### Removing a blockage in the dust container

#### Figure 26

- Empty the container. **Figure 20**
- Loosen the blockage, e.g. with a screwdriver, and tap or suck it out.

If sucking out, a dust bag must be inserted in the appliance. **Figure 18**

Fit the container cover, fold up the carrying handle and lock it in place on the cover.

- ! **Note:** After any malfunctions, you must clean the filters on the dust container (**figure 24** + **figure 25**).



## Filter care

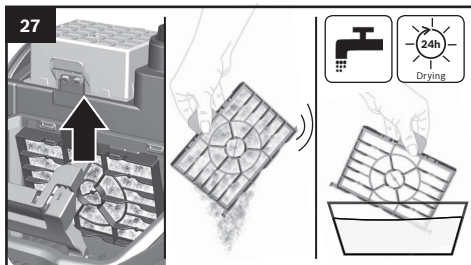

### Cleaning the motor protection filter

The motor protection filter should be cleaned regularly by tapping out the dirt and rinsing.

#### Figure 27

- Open the dust bag compartment lid. **Figure 20**
- Remove the motor protection filter in the direction of the arrow.
- Clean the motor protection filter by tapping out the dirt.
- If it is very dirty, the motor protection filter should be rinsed. Then allow the filter to dry for at least 24 hours.
- After cleaning, insert the motor protection filter into the appliance and close the dust bag compartment lid.

## Filter care

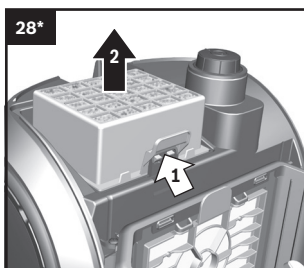

### Cleaning the washable HEPA filter

To ensure that the vacuum cleaner is working at its optimum power level, the exhaust filter should be rinsed out after one year. The filtering action of the filter remains intact, even if the filter surface becomes discoloured.

#### Figure 28\*

- Open the dust bag compartment lid. **Figure 20**
- Unlock the HEPA filter by moving the locking lever in the direction of the arrow and remove the filter from the appliance.

When doing so, first slide the rear part of the filter into the intended recess and then push it into the front, over the locking lever until it audibly locks in place.

- Tap out the filter unit and rinse it under running water.
- Alternatively, the unit can be cleaned in a washing machine at max. 30°C using a gentle programme and the lowest spin speed.

**TIP:** To protect other laundry items, put the filter unit into a laundry bag.

- Once the HEPA filter has dried completely (at least 24 hours), insert it back into the appliance.

After vacuuming fine dust particles, clean the motor protection filter and, if necessary, the HEPA filter.

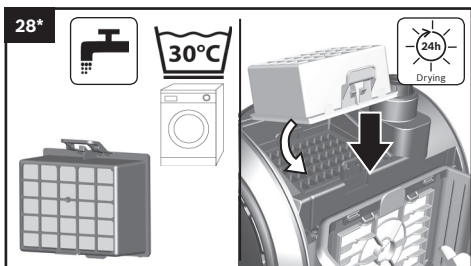

## Care

Always switch off the vacuum cleaner and disconnect the power cord from the mains before cleaning the vacuum cleaner. The vacuum cleaner and plastic accessories can be cleaned with a commercial plastic cleaner.

- ! **Do not use a scourer, glass-cleaning agent or multi-purpose cleaning products. Never immerse the vacuum cleaner in water.**

The dust compartment can, if necessary, be cleaned with a second vacuum cleaner or simply wiped with a dry cloth or dusting brush.

Subject to technical modifications.



## Customer service

### **GB Great Britain**

BSH Home Appliances Ltd.

Grand Union House

Old Wolverton Road

Wolverton

Milton Keynes MK12 5PT

To arrange an engineer visit, to order spare parts and accessories or for product advice please visit:

[www.bosch-home.co.uk](http://www.bosch-home.co.uk)

or call

Tel.: 0344 892 8979\*

\*Calls are charged at the basic rate, please check with your telephone service provider for exact charges.

### **HK Hong Kong, 香港**

BSH Home Appliances Limited

Unit 1 & 2, 3rd Floor

North Block, Skyway House

3 Sham Mong Road

Tai Kok Tsui, Kowloon

Hong Kong

Tel.: 2565 6151

Fax: 2565 6681

<mailto:bosch.hk.service@bshg.com>

[www.bosch-home.cn](http://www.bosch-home.cn)

### **SG Singapore, 新加坡**

BSH Home Appliances Pte. Ltd.

TECHPLACE I and

Mo Kio Avenue 10

Block 4012 #01-01

569628 Singapore

Tel.: 6751 5000

Fax: 6751 5005

<mailto:bshsgp.service@bshg.com>

[www.bosch-home.com.sg](http://www.bosch-home.com.sg)

## Disposal information

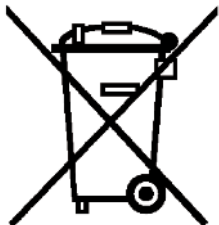

This appliance is labelled in accordance with European Directive 2012/19/EU concerning used electrical and electronic appliances (waste electrical and electronic equipment - WEEE). The guideline determines the framework for the return and recycling of used appliances as applicable throughout the EU.

### ■ Packaging

The packaging is designed to protect the vacuum cleaner from being damaged during transportation. It is made of environmentally friendly materials and can therefore be recycled.

Dispose of packaging that is no longer required at an appropriate recycling point.

### ■ Old appliances

Old appliances still contain many valuable materials. Therefore, please take appliances that have reached the end of their service to your retailer or recycling centre so that they can be recycled. For current disposal methods, please enquire at a retailer or your local council.

### ■ Disposal of filters and dust bags

Filters and dust bags are manufactured from environmentally friendly materials. Provided they do not contain substances that are not permitted in household waste, you can dispose of them with your normal household waste.

## **Conditions of guarantee**

For this appliance the guarantee conditions as set out by our representatives in the country of sale apply. Details regarding same may be obtained from the dealer from whom the appliance was purchased. For claims under guarantee the sales receipt must be produced.

## 安全信息

请保存好本说明手册以备需要时查看。如果将真空吸尘器转让给第三方，请务必同时转交本说明手册。

### 主要用途

本機僅限於私人家庭及非商業環境中使用。本機適合在海拔最高 2,000 公尺以下使用。  
僅可依照使用說明書上的指示使用本吸塵器。

为防止伤害和损坏，吸尘器不得用于以下用途：

- 真空清洁人或动物
- 真空吸取：
  - 危险、尖锐、灼热的物质。
  - 潮湿或液体物质。
  - 易燃、易爆物质和气体。
  - 来自于炉灶和集中供暖系统的燃烧灰烬或煤烟灰。
  - 打印机和复印机的墨粉。

### 零备件、附件、集尘袋

我们的原装零备件、原装（专用）附件和原装集尘袋根据我们的真空吸尘器产品的功能和要求专门设计。因此我们建议您仅使用我们的原装零备件、原装（专用）附件和原装集尘袋。这将确保您的真空吸尘器使用寿命长、吸尘清洁性能稳定高效。

！ 请注意

- 使用不适合的或品质低劣的零备件、（专用）附件和集尘袋可能损坏您的真空吸尘器。因使用此类产品而导致的损坏不在我们的保修范围内。

## 安全信息

本真空吸尘器符合公认的技术规范和相关的安法规。

- 8 岁以上儿童以及身体、感官或精神有缺陷的人员或缺乏经验和知识的人员，必须在有人监督或在得到电器使用安全指导并了解相关危险的情况下，方可使用本电器。
- 禁止儿童玩耍本电器。
- 禁止儿童在无人监督的情况下对本电器进行清洁和保养操作。
- 废弃前的塑料袋和塑料膜必须放在儿童无法接触的地方。  
=> 窒息危险。

### 正确使用

- 请仅根据铭牌上的规格连接和使用本真空吸尘器。
- 切勿在没有集尘袋或集尘容器、电机保护或排出过滤器的情况下进行真空吸尘操作。  
=> 这可能损坏真空吸尘器。
- 使用吸嘴和真空管的时候务必使真空吸尘器远离您的头部。  
=> 否则可能造成人身伤害！
- 当对楼梯进行真空吸尘时，吸尘器的位置必须低于使用者。
- 切勿通过拉扯电源线或软管来移动真空吸尘器。

- 出于安全考虑，如果本电器的电源线损坏，必须由制造商、制造商售后服务部门或具有类似资质的人员更换电源线。
- 如果使用电器的时间超过 30 分钟，请完全拔出电源线。
- 当为电器切断电源时，请拔掉电源插头本身，不要拉扯电源线。
- 不要使电源线接触锐物或者缠绕在一起。
- 如果电线自动缠绕，请确保电源插头不对准人、人体部位、动物或物体。  
=> 请使用电源插头引导电源线。
- 在对真空吸尘器进行任何操作前请拔出电源插头。
- 如果真空吸尘器损坏，请勿操作。如果检测到故障，请拔掉吸尘器电源插头。
- 出于安全考虑，仅允许经过授权的售后服务人员对真空吸尘器进行维修、安装和更换操作。
- 防止真空吸尘器遭受天气、潮湿和热源影响。
- 切勿在过滤装置（集尘袋、电机保护过滤器、排出过滤器，等等）上泼洒可燃物质或含酒精物质。
- 真空吸尘器不适用于建筑工地。  
=> 如果将其用于吸取建筑瓦砾，可能造成吸尘器损坏。
- 当不使用吸尘器时，请关闭电源并拔出电源插头。
- 如果电器寿命终结，应立即停止使用，然后以恰当方式废弃。

！ 请注意

- 电源插座必须通过至少 16 安培的断路器进行保护。如果在您开启真空吸尘器电源时，断路器跳闸，则可能是因为有其它更高电流消耗的电器连接到了同一电路上。为防止断路器跳闸，请选择最低功率设置，然后再开启电器电源，待电器运行起来后再增加功率。

### 废弃处置信息

- 包装  
包装的设计力求防止真空吸尘器在运输过程中遭到损坏。包装由环保材料制成，因此可回收利用。请将不再需要的废弃包装送至恰当的回收点。
- 旧电器  
旧电器仍然包含很多有价值的材料。因此，请将已寿命终结的电器送至您的经销商处或回收中心，以便回收利用。关于现行废弃处置方法，请咨询经销商或您当地的管理方。
- 过滤器和集尘袋的废弃处置  
过滤器和集尘袋均由环保材料制作而成。只要它们不包含不允许作为生活垃圾的物质，就可以将它们与普通生活垃圾一起废弃。

### 能效标签上的标示

本吸塵器為配備主要吸塵管之一般用途吸塵器。

电器集尘舱内可使用集尘袋或集尘盒。所标示数值为电器与集尘袋搭配使用时的数值。

若要在地毯上达到标称的能效和清洁性能等级，请使用可更换式通用吸嘴。

若要在带有隐秘角落和缝隙的硬质地面达到标称的能效和清洁性能等级，请使用所提供的硬质地面吸嘴。

計算方式基於授權規定（歐盟）編號665/2013由委員會於2013年5月3日訂訂以補充規範2010/30/EU的內容。

指示內未有詳述的所有程序已按照DIN EN 60312-1:2017\*列出。

\*由於馬達運轉試驗是在集塵容器為空時進行，在集塵容器半滿時，所述之馬達運轉壽命必須增加10%。

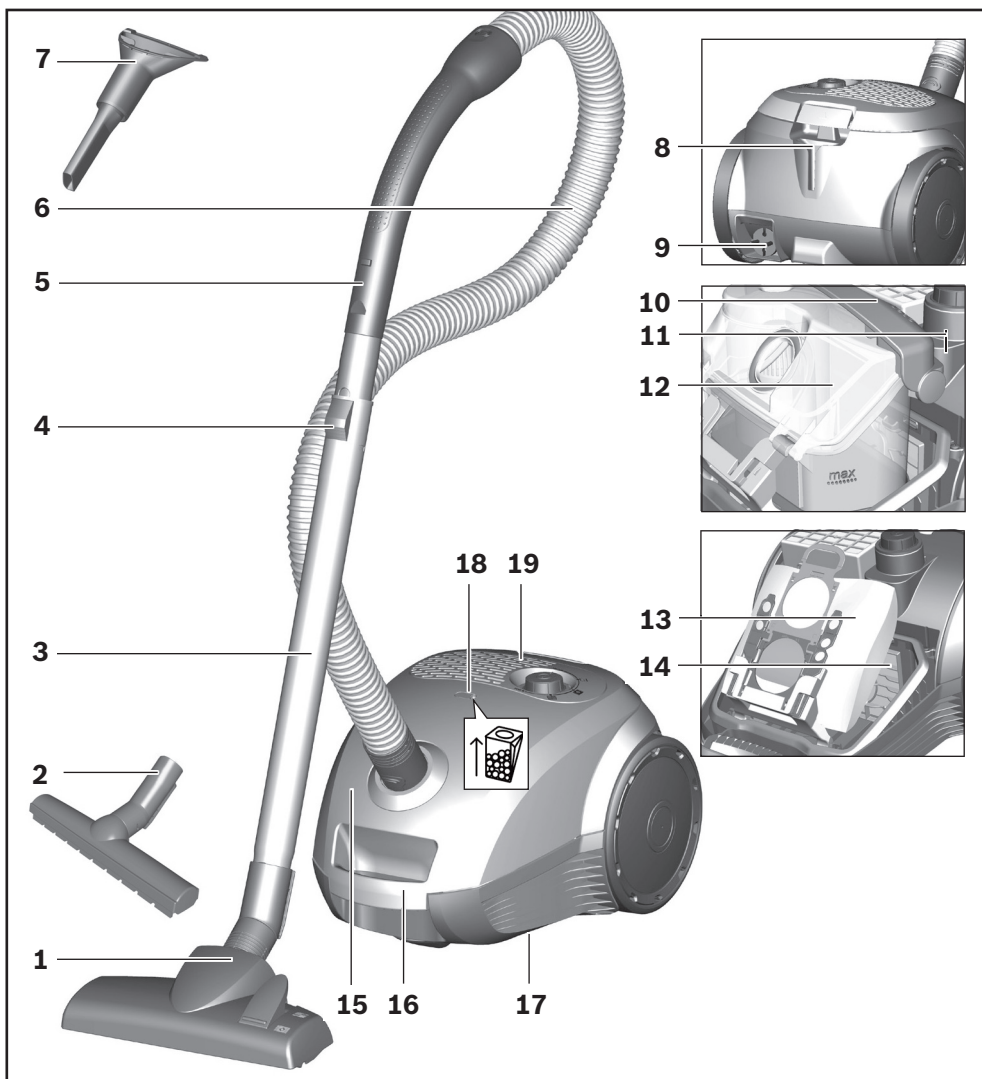

- 1 可调节的吸尘扒\*
- 2 硬质地面吸尘扒\*
- 3 伸缩管\*
- 4 滑动开关\*
- 5 手柄\*
- 6 活动软管
- 7 多用途吸嘴
- 8 辅助站立装置
- 9 电源线
- 10 排出过滤器

- 11 带电动吸尘调节器的开 / 关按钮\*
- 12 代替集尘袋的集尘容器\*或者替换用的集尘袋\*
- 13 集尘袋
- 14 可洗的电机保护过滤器
- 15 集尘袋舱盖
- 16 搬运手柄
- 17 存储辅助装置 (在电器底部)
- 18 集尘袋更换指示器\*
- 19 排出格栅

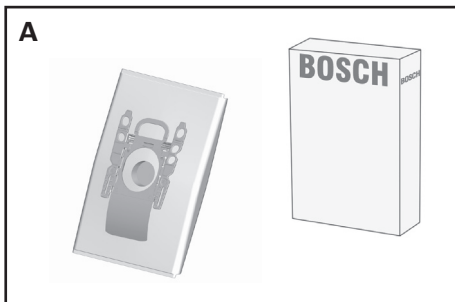

### A 替换过滤套装

为使您的电器发挥最大功用，我们建议使用 PowerProtect 全套替换套装 (BBZ41FGALL)。

内含：

- 4 个带扎口的集尘袋
- 1 个微型卫生过滤器

### ！ 请注意

因此我们建议您仅使用我们的原装集尘袋。

您的高效真空吸尘器配合高品质集尘袋将实现出色的清洁效果。只有使用高品质集尘袋（例如博世原装集尘袋）才能确保您的真空吸尘器以电器上的欧盟能效标签列出的能效等级、集尘率和集尘容量进行工作。

使用劣质集尘袋（如纸袋）可能对电器使用寿命和性能造成负面影响。使用不合适的或品质低劣的集尘袋还可能损坏您的真空吸尘器。此类损坏不在我们的保修范围内。

您可在以下网站查看更多相关信息：

[www.bosch-home.com/dust-bag](http://www.bosch-home.com/dust-bag) 您可在该处订购我们的原装真空吸尘器集尘袋。



### B EPA 过滤器 BBZ156HF

用于吸尘器排出废气的额外过滤器。

推荐易过敏人群使用。每年更换一次。

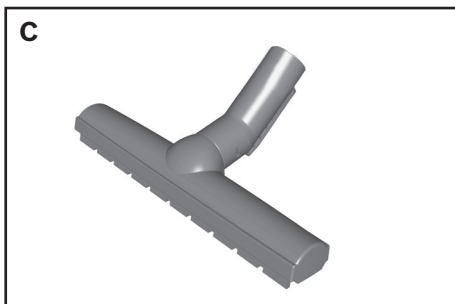

### C 硬质地面吸尘扒 BBZ123HD

用于硬质地面的吸尘

(如镶木地板、瓷砖、赤陶等)。

## 首次使用前



图 1

- 将手柄推至活动软管，锁止到位。

## 初次使用

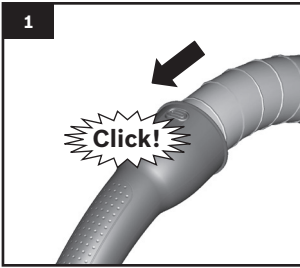

图 2

- a) 将活动软管连接件推入盖子内的进气口，直至锁止到位。
- b) 若要取下活动软管，请同时按压两个锁扣，然后拉出软管。

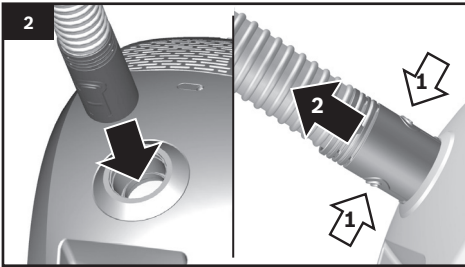

图 3

- 将手柄推入吸管 / 伸缩管。
- 若要将其取下，请轻轻旋转手柄，然后将其拉出吸管 / 伸缩管。

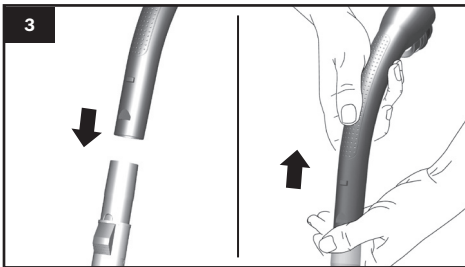

图 4

- 将吸管 / 伸缩管推入吸尘扒的连接件。
- 若要取消连接，请轻轻旋转吸管 / 伸缩管，然后将其拉出吸尘扒。

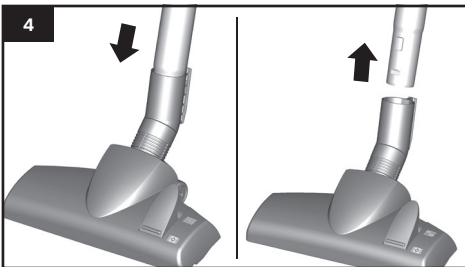

图 5

- 按照箭头方向移动滑动开关，使伸缩管解锁，然后将其调节至所需的长度。

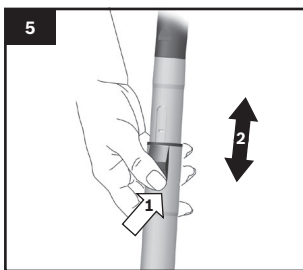

图 6

- 握住电源线的插头，向外拉电源线，直至所需长度，然后将插头插入电源插座。

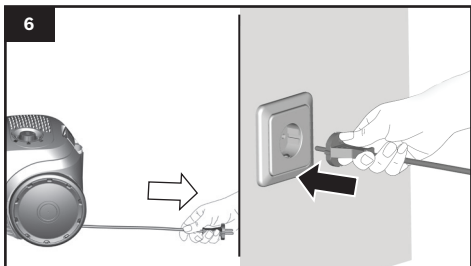

图 7

- 若要开启或关闭真空吸尘器，请按照箭头方向按压开 / 关按钮。

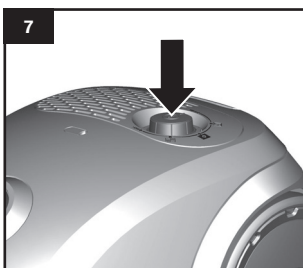
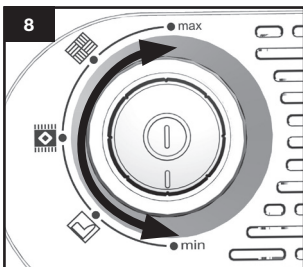

控制吸尘水平

图 8

按照箭头方向旋转开 / 关按钮可设置吸尘水平。

按照箭头方向旋转控制旋钮可根据需要无限地调节吸尘水平。

最小 - 適合清理窗簾和精緻布料

 - 適合清理傢俱和坐墊

 - 適合清理精緻地墊，以及日常輕微骯髒的地板

 - 適合清理抗磨的地板覆蓋物

最大 - 適合清理硬質地板和非常骯髒的地墊或坐墊





图 9

调节吸尘扒：

- 地毯
- 硬质地面

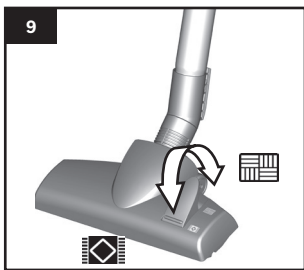

请注意：

吸尘扒能够承受一定程度的磨损，具体取决于硬质地面的类型（如粗糙的瓷砖）。因此您必须定期检查吸尘扒的底部。磨损的吸尘扒底部可能有尖锐边缘，可能会损坏精细脆弱的硬质地面，如地毯和油毡。由于吸尘扒磨损而造成的损坏，制造商概不负责。



图 10\* 带附件进行吸尘

按照要求把吸嘴连接至吸尘管或手柄：

- a) 用于清洁缝隙和角落等的缝隙吸嘴。
- b) 用于清洁带座套的家具、窗帘等的座套吸嘴。
- c) 硬质地面吸尘扒  
用于清洁硬质地面材料（如瓷砖和镶木地板等）。

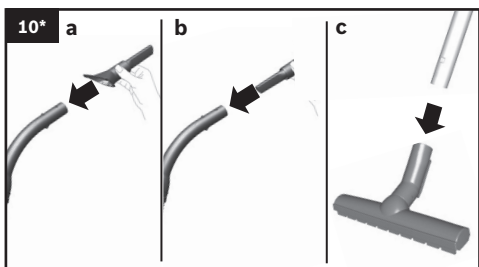

图 11

如果您需要暂停吸尘，可使用吸尘器侧面的辅助站立装置。关闭电器后，将吸尘扒上的钩子滑入吸尘器侧面的凹槽。

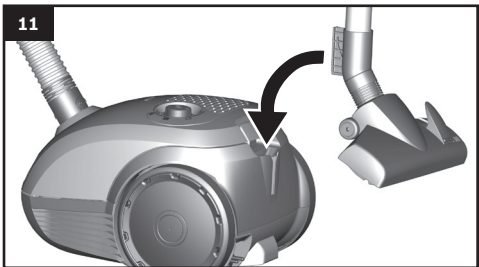

图 12

例如在楼梯上进行真空吸尘时，也可通过手柄移动吸尘器。

## 使用电器后

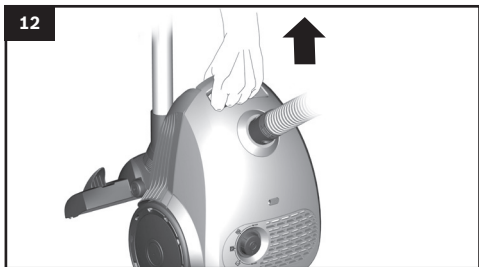

图 13

- 拔下电源插座。
- 轻轻拉动电源线，然后松开（电源线会自动收回）。

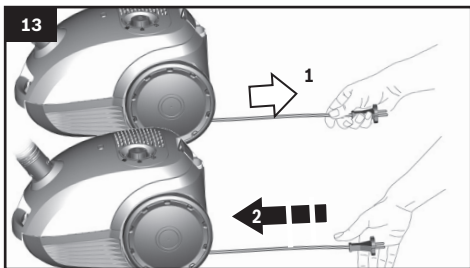

图 14

若要存储 / 运输电器，可使用电器底部的辅助存储装置。把电器立起来。将吸尘扒上的钩子滑入吸尘器底部的凹槽。

您购买的是地面真空吸尘器，它可以通过集尘容器或集尘袋吸收任何类型的干燥灰尘。

我们建议您：

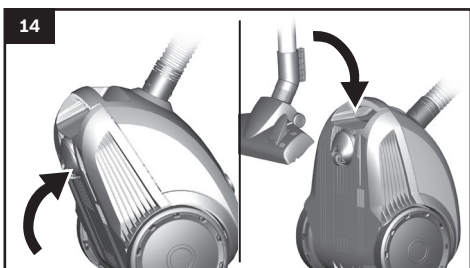
- 日常家庭清洁主要使用集尘袋。
- DIY 相关的清洁（特别是清洁木屑等）使用集尘容器。

## 使用集尘袋



### 更换集尘袋

图 15

- 当选择了最高吸尘水平将吸尘扒从地面抬起时，如果盖子上的集尘袋更换指示器完全充满，那么，即便集尘袋可能还没有装满，也必须更换集尘袋。由于通过真空吸入的灰尘类型不一，即便集尘袋没有装满，也可能需要更换。首先检查吸嘴、吸尘管和活动软管是否堵塞，如有堵塞则可能触发集尘袋更换指示器。



图 16

- 按照箭头方向释放锁止杆，以解锁盖子。

## 使用集尘袋

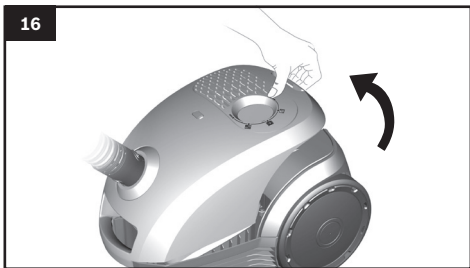

图 17

- 拉动锁片以关闭集尘袋，然后取下。
  - 插入一个新的集尘袋，将其完全推入支座。
- ！ 请注意：只有当插入集尘袋后，盖子才会关闭。

## 使用集尘容器

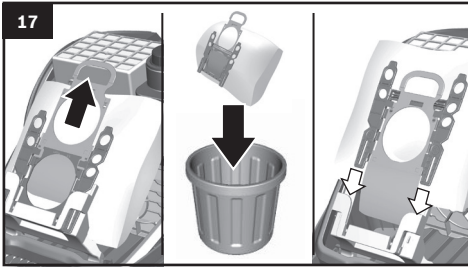
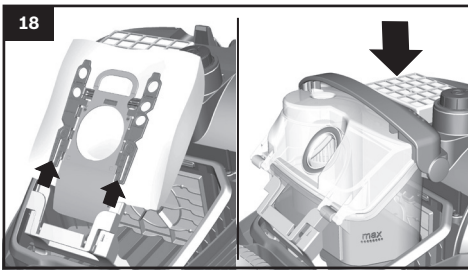

如有必要，可使用集尘容器代替集尘袋。

！ 请注意：只有使用集尘袋时，集尘袋更换指示器才起作用。

图 18

- 打开集尘袋舱盖。
- 取下集尘袋，插入集尘容器。
- 关闭电器盖。



图 19

吸尘操作时，请将功率设置为最大值，以实现最佳效果。  
我们建议您仅在清洁非常精细脆弱的材料时才降低设置值。

### 清空集尘容器

为了尽可能实现最佳吸尘效果，应在每次使用后清空集尘容器，或者最迟等到集尘容器内的灰尘达到最大标记时就清空集尘容器。

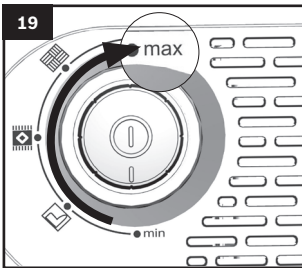
清空集尘容器时，务必检查集尘容器底部的泡沫过滤器的脏污程度。

如果明显脏污，则请按照从图 24 开始的说明清洁泡沫过滤器。



图 20

- 按照箭头方向移动锁止杆，以打开集尘袋舱盖。



图 21  
● 从电器上取下集尘容器。

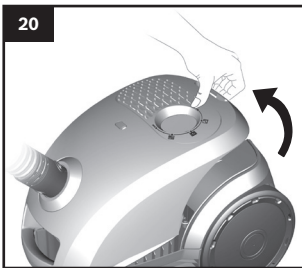

图 22  
● 向后折叠搬运手柄，远离进气口。  
● 从容器上取下盖子，然后放到一侧。  
● 清空容器。  
● 把盖子钩到容器内，然后关闭容器。  
● 折起搬运手柄，然后将其锁到盖子上。



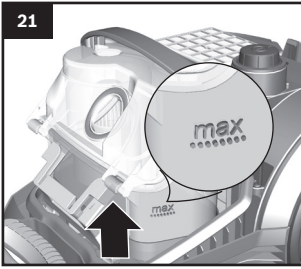
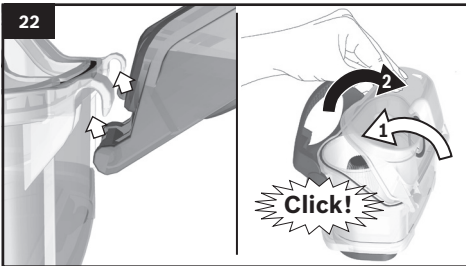
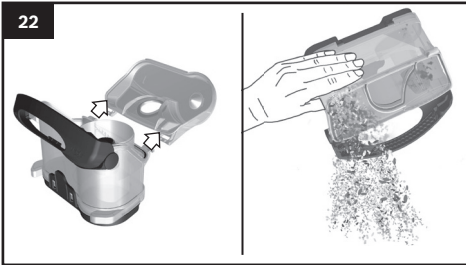

图 23

- 将集尘容器重新插入电器，然后关闭集尘袋舱盖。
- ！ 请注意：随着使用的增多，集尘容器的内部可能出现刮痕，开始变得暗淡不透明。然而，这丝毫不影响真空吸尘器的任何性能，它将继续照常起作用。

清洁集尘容器内的绒毛过滤器 (a) 和泡沫过滤器 (b)

必须清洁过滤器：

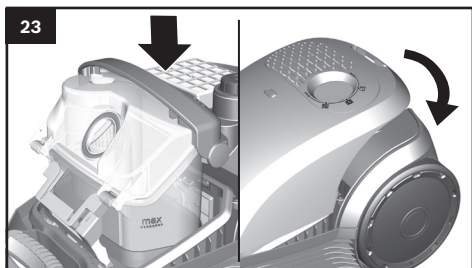
- 任何故障之后，即清除堵塞后
- 如果过滤器上有明显的脏污
- 至少每三个月一次



图 24

- 解锁集尘容器后侧的锁片，打开容器底部的底板。
- 从底板取下两个过滤器 (a + b)。

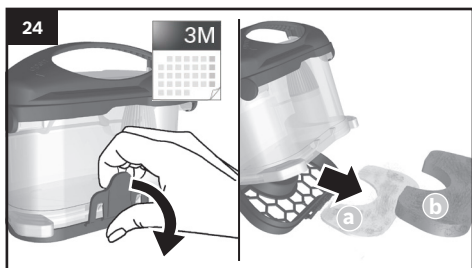

图 25

- 清洗两个过滤器 (a + b)，晾干至少 24 小时。
- 清洁后，将两个过滤器重新插回底板。
- 关闭底板，然后推入锁片，直至听到其“咔哒”一声接合到位。

- ！ 注意：插入过滤器时，必须遵守正确的顺序。泡沫过滤器 (b) 必须位于绒毛过滤器 (a) 的上面。

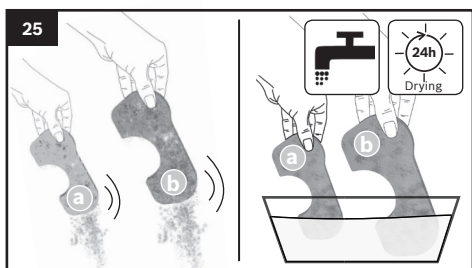
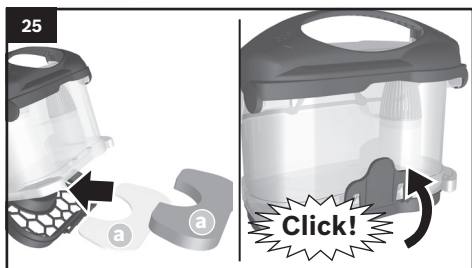

## 故障

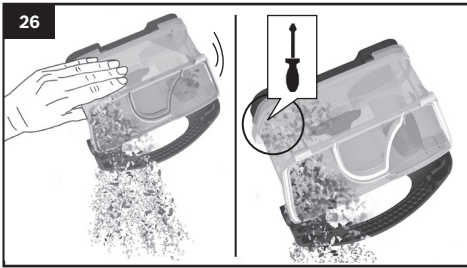

清除集尘容器的堵塞

图 26

- 清空容器。图 20
- 使堵塞物松开（例如使用螺丝刀），然后将其敲出来或吸出来。  
如果吸出来，则必须为电器插上集尘袋。图 18  
装上容器盖，折起搬运手柄并将其锁定到盖子上。

！ 注意：任何故障后都必须清洁集尘容器内的过滤器（图 24 + 图 25）。



## 过滤器保养

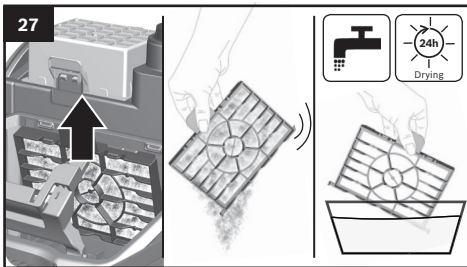

清洁电机保护过滤器

应定期清洁电机保护过滤器，具体方法是把脏污敲出来，然后冲洗。

图 27

- 打开集尘袋舱盖。图 20
- 按照箭头方向取下电机保护过滤器。
- 清洁电机保护过滤器，具体方法是把脏污敲出来。
- 如果电机保护过滤器严重脏污，则应冲洗。  
然后使过滤器晾干至少 24 小时。
- 清洁后，将电机保护过滤器插入电器，然后关闭集尘袋舱盖。

## 过滤器保养

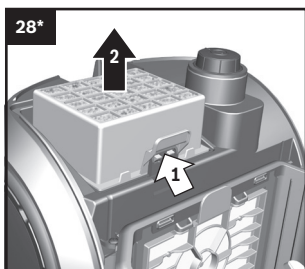

清洁可清洗的 HEPA 过滤器

为确保真空吸尘器以最佳功率水平运转，排出过滤器使用一年后应清洗。即使过滤器表面褪色，其过滤功能也丝毫不受影响。

图 28\*

- 打开集尘袋舱盖。图 20
- 按照箭头方向移动锁止杆，以解锁 HEPA 过滤器，然后从电器取出过滤器。

在此操作期间，首先将过滤器的后部滑入目标凹槽，然后将其推入前部，超过锁止杆，直至听到锁止到位的声音。

- 敲出过滤器内的脏污，然后在流水下冲洗。
- 或者，也可用洗衣机清洗过滤装置，最高水温 30°C，使用温和程序和最低转速。

提示：为保护其它清洗物，请把过滤装置放入清洗保护袋。

- 待 HEPA 过滤器彻底干燥后（至少 24 小时），将其插回电器。

清洁微细尘粒后，清洁电机保护过滤器，必要时则清洁 HEPA 过滤器。

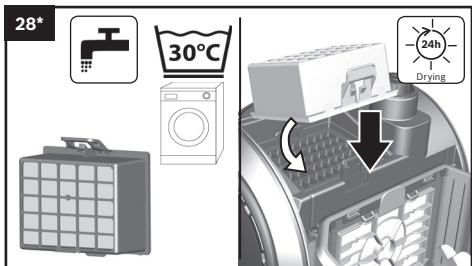

## 保养

在清洁真空吸尘器前，务必关闭真空吸尘器的电源并将电源线拔掉。可使用商用塑料清洁剂清洁真空吸尘器和塑料附件。

！切勿使用除垢剂、玻璃清洁剂或多用途清洁剂。切勿将真空吸尘器浸入水中。

如有必要，可使用另一个真空吸尘器清洁集尘舱，或者就用干布或除尘刷清洁。

有可能进行技术变更。

**GB Great Britain**

BSH Home Appliances Ltd.

Grand Union House

Old Wolverton Road

Wolverton

Milton Keynes MK12 5PT

To arrange an engineer visit, to order spare parts and accessories or for product advice please visit:

[www.bosch-home.co.uk](http://www.bosch-home.co.uk)

or call

Tel.: 0344 892 8979\*

\*Calls are charged at the basic rate, please check with your telephone service provider for exact charges.

**HK Hong Kong, 香港**

BSH Home Appliances Limited

Unit 1 & 2, 3rd Floor

North Block, Skyway House

3 Sham Mong Road

Tai Kok Tsui, Kowloon

Hong Kong

Tel.: 2565 6151

Fax: 2565 6681

<mailto:bosch.hk.service@bshg.com>

[www.bosch-home.cn](http://www.bosch-home.cn)

**SG Singapore, 新加坡**

BSH Home Appliances Pte. Ltd.

TECHPLACE I and

Mo Kio Avenue 10

Block 4012 #01-01

569628 Singapore

Tel.: 6751 5000

Fax: 6751 5005

<mailto:bshsgp.service@bshg.com>

[www.bosch-home.com.sg](http://www.bosch-home.com.sg)



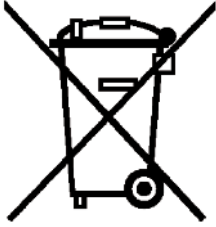

此吸塵機受歐盟2012/19/EU有關舊電器及電子產品(廢棄電器和電子設備- WEEE)指引監管, 該指引確立了適用於整個歐盟的舊電器回收和再造的規章制度。

■ **包裝**

產品包裝旨在保護吸塵機於運輸過程中不受損壞, 以環保材料製成, 因此可被循環再造, 不再需要找專門的回收點棄置。

■ **舊電器**

舊電器裡仍有很多可用的物料。因此, 請將無法使用的電器送交零售商或回收中心, 讓它們可循環電造。有關目前的棄置方法, 請聯絡零售商或當地有關政府部門。

■ **棄置濾網及塵袋**

濾網及塵袋以環保材料製造。除了含有不能以家居廢物棄置的物質外, 濾網及塵袋均可當作一般家居廢物處理。





 Beratung und Reparaturauftrag bei Störungen

DE 0911 70 440 040

AT 0810 550 511

CH 0848 840 040

Die Kontaktdaten aller Länder finden Sie im beiliegenden Kundendienst-Verzeichnis.

**Robert Bosch Hausgeräte GmbH**

**Carl-Wery-Straße 34**

**81739 München, GERMANY**

**[www.bosch-home.com](http://www.bosch-home.com)**

